



Italian manufacturing
EXCELLENCE, IN EVERY SINGLE PIECE



COS.PEL®, from a family business to an industrial group, represents more than 25 years of Italian tradition in the design-production and marketing of truck and light truck body spare parts suitable to all European brands with a constant engagement to assure the market the availability of a complete range of high quality products perfectly interchangeable with the original ones. The Company has always been oriented to continuous investments in machineries and moulds and to an internal production implementing an integrated process of product development, optimizing its capability of quality and service management. By using recyclable raw materials and alternative energy sources **COS.PEL®** confirms its aptitude to "environment respectful" company.

The presence in the market is guaranteed by a domestic and international distribution network leaded by highly qualified distributors/partners.

- **A plant of 40.000 sqm on a total area of 100.000 sqm**
- **More than 7.000 available items**
- **24h order processing**
- **Distributed in Italy and in more than 50 countries all over the world**





COS.PEL., da business familiare a gruppo industriale, rappresenta più di 25 anni di tradizione italiana nella progettazione, produzione e marketing di parti di ricambio di carrozzeria adattabili per i veicoli industriali e commerciali di tutte le marche europee con un impegno costante ad assicurare al mercato la disponibilità di una gamma completa di prodotti di alta qualità perfettamente intercambiabili con i prodotti originali.

La società è da sempre orientata a continui investimenti in macchinari e stampi ed alla produzione interna che le permette un processo integrato nello sviluppo del prodotto, ottimizzando la propria capacità di gestione della qualità e del servizio. L'utilizzo di materie prime riciclabili e fonti di energia alternativa fanno di **COS.PEL.** un'azienda attenta all'ambiente.

La presenza sul mercato è assicurata da una rete distributiva nazionale ed internazionale guidata da distributori/partner altamente qualificati.

- **Stabilimento di 40.000 mq coperti su una superficie totale disponibile di 100.000 mq**
- **Oltre 7.000 articoli disponibili**
- **Gestione ordini entro 24h**
- **Distribuzione in Italia ed in più di 50 paesi nel mondo**





COS.PEL.[®]

BODY PARTS





Italian manufacturing

**EXCELLENCE,
IN EVERY
SINGLE PIECE**



Le marche utilizzate in questo catalogo, così come i riferimenti originali inclusi, servono unicamente per aiutare ad identificare l'articolo.

Tutti i componenti citati nel nostro catalogo e listino non sono originali, ma perfettamente intercambiabili. Gli stessi vengono impiegati ed utilizzati solo per veicoli in circolazione e solo dopo autorizzazione da parte del proprietario del veicolo in riparazione. L'applicabilità di eventuali brevetti alla vendita dei nostri componenti (carrozzeria, fanaleria, specchi e altri accessori) è diversa nei vari Paesi. Eventuali infrazioni delle legislazioni locali sono da attribuire al rivenditore nel Paese finale di distribuzione.

The brands adopted in this catalogue, as well as the OE codes included, only attend to help the identification of the body part. All the items mentioned in our catalogue and price list are not original parts but perfectly interchangeable with them. These parts are used only on vehicles in circulation and exclusively under authorization of the owner of the vehicle in repair. Applicability of patents, if any, to the sale of our components (body parts, lights, lamps, mirrors and others) differs in each Country. Infringements of local legislation are responsibility of the retailer in the country of final distribution.



Parti di ricambio adattabili a:
Spare parts suitable to:

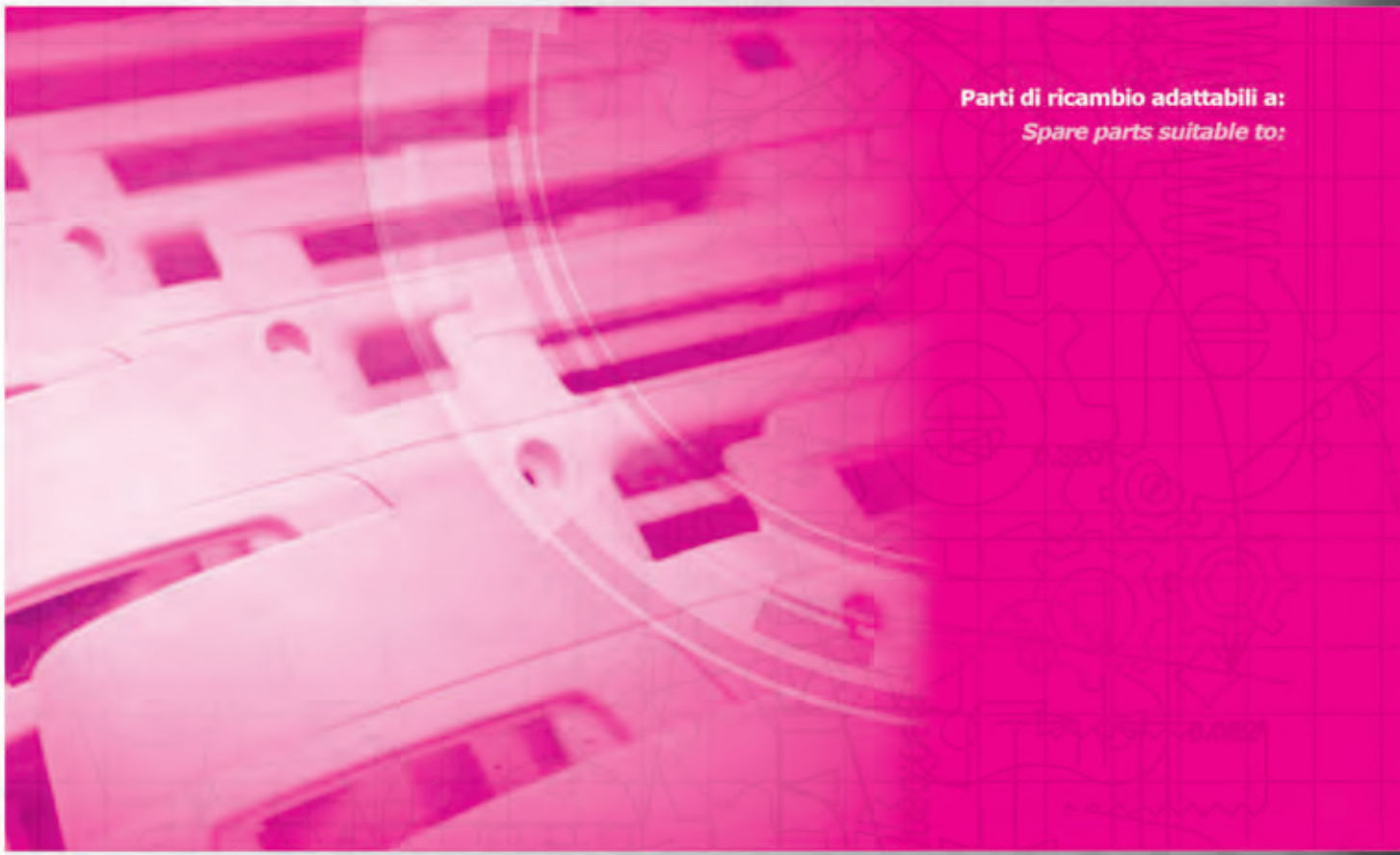

Master 1999



	<p>COFANO METALLO HOOD STEEL</p> <p>COS.PEL. ref. SIMILAR ref. 101.69067 7751469067</p>
	<p>SUPPORTO FRONTALE METALLO RADIATOR SUPPORT PANEL STEEL</p> <p>COS.PEL. ref. SIMILAR ref. 101.88434 7751688434 DX RH</p> <p>101.88433 7751688433 SX LH</p>
	<p>TRAVERSA FRONTALE INFERIORE METALLO LOWER RADIATOR SUPPORT PANEL METAL</p> <p>COS.PEL. ref. SIMILAR ref. 101.88435 7751688435</p>
	<p>TRAVERSA FRONTALE SUPERIORE METALLO UPPER RADIATOR SUPPORT PANEL METAL</p> <p>COS.PEL. ref. SIMILAR ref. 101.90121 7751690121</p>
	<p>PARAFANGO METALLO MUDGUARD STEEL</p> <p>COS.PEL. ref. SIMILAR ref. 201.00000 7750350505 DX RH</p> <p>201.00001 7750350504 SX LH</p>

	<p>PROTEZIONE RUOTA P.P. - NERO WHEEL PROTECTION P.P. - BLACK COS.PEL. ref. SIMILAR ref. 201.00002 8200432028</p> <p>201.00003 8200432027</p> <p style="text-align: right;">DX RH</p> <p style="text-align: right;">SX LH</p>
	<p>PARAURTI ANTERIORE P.P. - NERO - 1999/2003 FRONT BUMPER P.P. - BLACK - 1999/2003 COS.PEL. ref. SIMILAR ref. 401.70784 7701470784</p>
 	<p>FANALINO LATERALE P21W CORNER LAMP P21W COS.PEL. ref. SIMILAR ref. 1601.00002 7701044523</p> <p>1601.00003 7701044522</p> <p style="text-align: right;">DX RH</p> <p style="text-align: right;">SX LH</p>
 	<p>FANALINO LATERALE P21W CORNER LAMP P21W COS.PEL. ref. SIMILAR ref. 1601.00004 7700353947</p> <p>1601.00005 7700353946</p> <p style="text-align: right;">DX RH</p> <p style="text-align: right;">SX LH</p>
 	<p>PROIETTORE H4/W5W - PREDISPOSTO PER CORRETTORE ASSETTO HEADLAMP H4/W5W - SUITABLE FOR LOAD LEVEL ADJUSTEMENT COS.PEL. ref. SIMILAR ref. 1601.00000 7701044520</p> <p>1601.00001 7701044518</p> <p style="text-align: right;">DX RH</p> <p style="text-align: right;">SX LH</p>
	<p>GUARNIZIONE PARABREZZA WINDSCREEN GASKET COS.PEL. ref. SIMILAR ref. 1801.36000 7700351250 / 8200106346</p>
<p>AD ESAURIMENTO SCORTE W/INTL. SELL-OUT</p> 	<p>ALZACRISTALLI ELETTRICO - CON MOTORINO - 6 PIN WINDOW REGULATOR ELECTRIC - WITH MOTOR - 6 PIN COS.PEL. ref. SIMILAR ref. 1901.00500 8200162710</p> <p style="text-align: right;">DX RH</p>

Master 2003



	<p>COFANO METALLO HOOD STEEL</p> <p>COS.PEL. ref. SIMILAR ref. 101.03000 7751474717</p>
	<p>FRONTALE METALLO FRONTAL PANEL STEEL</p> <p>COS.PEL. ref. SIMILAR ref. 101.03001 8200187234</p>
	<p>PARAFANGO METALLO MUDGUARD STEEL</p> <p>COS.PEL. ref. SIMILAR ref. 201.03100 7751475534 DX RH</p> <p>201.03101 7751475533 SX LH</p>
	<p>PARAURTI ANTERIORE P.P. - NERO FRONT BUMPER P.P. - BLACK</p> <p>COS.PEL. ref. SIMILAR ref. 401.03090 8200197134</p>
 	<p>FANALINO LATERALE PY21W CORNER LAMP PY21W</p> <p>COS.PEL. ref. SIMILAR ref. 1601.03802 8200163918 DX RH</p> <p>1601.03803 8200163914 SX LH</p>

 	<p>FANALINO LATERALE PY21W CORNER LAMP PY21W</p> <p>COS.PEL. ref. SIMILAR ref. 1601.03804 8200263364</p> <p>1601.03805 8200263356</p> <p style="text-align: right;">DX RH SX LH</p>
 	<p>PROIETTORE H7/H1/W5W - CORRETTORE ASSETTO MANUALE HEADLAMP H7/H1/W5W - MANUAL LOAD LEVEL ADJUSTEMENT</p> <p>COS.PEL. ref. SIMILAR ref. 1601.03800 8200163518</p> <p>1601.03801 8200163516</p> <p style="text-align: right;">DX RH SX LH</p>
	<p>KIT PER CONNESSIONI ELETTRICHE Connettore AMP 1,5 singolo KIT FOR ELECTRICAL JOINTS Connector AMP 1,5 simple</p> <p>COS.PEL. ref. SIMILAR ref. 003120 -</p>
 	<p>FARO POSTERIORE PY21W REAR-LIGHT PY21W</p> <p>COS.PEL. ref. SIMILAR ref. 003810 8200228395</p> <p>003811 8200228394</p> <p>TRASPARENTE / LENS</p> <p style="text-align: right;">DX RH SX LH</p>
	<p>FANALE POSTERIORE 5 FUNZIONI - CONNETTORE POSTERIORE AMP 1.5 REAR-LIGHT 5 FUNCTIONS - REAR CONNECTOR AMP 1.5</p> <p>COS.PEL. ref. SIMILAR ref. 1501.03000 4421266 / 5001870556 DX RH</p> <p>(ex 007880/007900) - Connettore 003120</p> <p>1501.03001 4421265 / 7485118470 SX LH</p> <p>Con luce targa / W. plate light (ex 007880/007900) - Conn. 003120</p> <p>TRASPARENTE / LENS</p> <p>1501.03100 5001847153 (ex 011591) DX-SX RH-LH</p>

Master 3 Phase 1 2010







	<p>COFANO METALLO - NERO HOOD METAL - BLACK</p> <p>COS.PEL. ref. SIMILAR ref. 101.04000 7485120759</p>
	<p>SUPPORTO FRONTALE METALLO - NERO FRONT MOUNTING BRACKET METAL - BLACK</p> <p>COS.PEL. ref. SIMILAR ref. 101.04001 8200657209</p>
	<p>GRIGLIA FRONTALE FRONT GRILLE</p> <p>COS.PEL. ref. SIMILAR ref. 101.04002 623100256R / 7485120742 / 7485143226</p>
	<p>PARAFANGO METALLO - NERO MUDGUARD METAL - BLACK</p> <p>COS.PEL. ref. SIMILAR ref. 201.04100 7485120747 DX RH</p> <p>201.04101 7485120748 SX LH</p>
	<p>RINFORZO PARAURTI METALLO - NERO BUMPER BRACKET METAL - BLACK</p> <p>COS.PEL. ref. SIMILAR ref. 401.04089 7485122193</p>

	<p>PARAURTI ANTERIORE P.P. - NERO FRONT BUMPER P.P. - BLACK</p> <p>COS.PEL. ref. SIMILAR ref. 401.04090 62010BZ50A / 620220006R / 7485120736</p>
	<p>PARAURTI ANTERIORE CON FORI FENDI P.P. - NERO FRONT BUMPER WITH HOLES P.P. - BLACK</p> <p>COS.PEL. ref. SIMILAR ref. 401.04091 62010BZ51A / 620220007R / 7485120738</p>
	<p>ANGOLO PARAURTI POSTERIORE P.P.T. - NERO REAR CORNER BUMPER P.P.T. - BLACK</p> <p>COS.PEL. ref. SIMILAR ref. 401.04092 851200001R DX RH</p> <p>401.04093 851210001R SX LH</p>
	<p>SPECCHIO RETROVISORE MANUALE REAR-VIEW MIRROR MANUAL</p> <p>COS.PEL. ref. SIMILAR ref. 501.04010 7485120974 DX RH</p> <p>501.04011 7485120981 SX LH</p>
	<p>SPECCHIO RETROVISORE ELETTRICO - RISCALDATO REAR-VIEW MIRROR ELECTRIC - HEATED</p> <p>COS.PEL. ref. SIMILAR ref. 501.04012 7485120975 / 963016903R DX RH</p> <p>501.04013 7485120982 / 963021976R SX LH</p>
	<p>VETRO SPECCHIO MIRROR GLASS</p> <p>COS.PEL. ref. SIMILAR ref. 501.04014 7485120988 DX RH</p> <p>501.04015 7485120990 SX LH</p>
	<p>VETRO SPECCHIO CON ADESIVO GLASS WITH SELF ADHESIVE</p> <p>COS.PEL. ref. SIMILAR ref. 501.04016 - DX RH</p> <p>501.04017 - SX LH</p>
	<p>COPERCHIO RETROVISORE MIRROR COVER</p> <p>COS.PEL. ref. SIMILAR ref. 501.04018 - DX RH</p> <p>501.04019 - SX LH</p>

Master 3 Phase 1 2010

	<p>RIVESTIMENTO PORTA ANTERIORE P.P.T. - NERO FRONT DOOR MOULDING P.P.T. - BLACK COS.PEL. ref. SIMILAR ref. 801.04000 7485122727 DX RH</p> <p>801.04001 7485122728 SX LH</p>
	<p>RIVESTIMENTO LATERALE P.P.T. - NERO SIDE MOULDING P.P.T. - BLACK COS.PEL. ref. SIMILAR ref. 801.04002 7485122295 / 7485122297 DX-SX RH-LH</p>
	<p>RIVESTIMENTO PORTELLONE CENTRALE P.P.T. - NERO MIDDLE DOOR MOULDING P.P.P.T. - BLACK COS.PEL. ref. SIMILAR ref. 801.04004 7485122751 DX RH</p> <p>801.04003 7485122752 SX LH</p>
	<p>RIVESTIMENTO LATERALE (PARTE CENTRALE) P.P.T. - NERO - C/FORO LUCE SIDE MOULDING (CENTRAL PART) P.P.T. - BLACK - W/LAMP HOLE COS.PEL. ref. SIMILAR ref. 801.04006 7485122505 DX RH</p> <p>801.04005 7485122298 SX LH</p>
	<p>RIVESTIMENTO LATERALE (PARTE CENTRALE) P.P.T. - NERO SIDE MOULDING (CENTRAL PART) P.P.T. - BLACK COS.PEL. ref. SIMILAR ref. 801.04008 7485122506 DX RH</p> <p>801.04007 7485122501 SX LH</p>
	<p>RIVESTIMENTO LATERALE (PARTE POSTERIORE) P.P.T. - NERO - C/FORO LUCE SIDE MOULDING (REAR PART) P.P.T. - BLACK - W/LAMP HOLE COS.PEL. ref. SIMILAR ref. 801.04010 7485122511 DX RH</p> <p>801.04009 7485122504 SX LH</p>
	<p>RIVESTIMENTO CERNIERA (PORTA POSTERIORE) HINGE MOULDING (REAR DOOR) COS.PEL. ref. SIMILAR ref. 801.04012 8200057680 DX RH</p> <p>801.04011 8200057679 SX LH</p>
 	<p>PROIETTORE H7/H7/H1/PY21W/W5W - CORRETTORE ASSETTO MANUALE HEADLAMP H7/H7/H1/PY21W/W5W - MANUAL LOAD LEVEL ADJUSTEMENT COS.PEL. ref. SIMILAR ref. 1601.04080 7485120611 DX RH</p> <p>1601.04081 7485120616 SX LH</p>

Master 3 Phase 1 2010

 	<p>FENDINEBBIA H11 FOG LAMP H11</p> <p>COS.PEL. ref. SIMILAR ref.</p> <p>1601.04082 8200002470 / 8200301027 DX RH</p> <p>1601.04083 8200002469 / 8200301026 SX LH</p>
 	<p>FANALE POSTERIORE SENZA PORTALAMPADA REAR-LIGHT WITHOUT LAMPHOLDER</p> <p>COS.PEL. ref. SIMILAR ref.</p> <p>007910 265500023R / 7485120625 DX RH</p> <p>007911 265550023L / 7485120626 SX LH</p> <p>TRASPARENTE / LENS</p>



 	<p>PROIETTORE H4/PY21W/W5W - ELETTRICO SENZA MOTORINO HEADLAMP H4/PY21W/W5W - ELECTRIC WITHOUT MOTOR COS.PEL. ref. SIMILAR ref. 1601.05060 5001872437 DX RH</p> <p>1601.05061 5001872439 SX LH</p>
 	<p>PROIETTORE H4/P21W/W5W - ELETTRICO SENZA MOTORINO HEADLAMP H4/P21W/W5W - ELECTRIC W/O MOTOR COS.PEL. ref. SIMILAR ref. 1601.05062 26010-MB400 DX RH</p> <p>1601.05063 26060-MB400 SX LH</p>
 	<p>FENDINEBBIA H11 FOG LAMP H11 COS.PEL. ref. SIMILAR ref. FO141602 1209177 / 8200074008 DX-SX RH-LH</p>
	<p>KIT PER CONNESSIONI ELETTRICHE Connettore AMP 1,5 singolo KIT FOR ELECTRICAL JOINTS Connector AMP 1,5 simple COS.PEL. ref. SIMILAR ref. 003120 -</p>
	<p>FANALE POSTERIORE 5 FUNZIONI - CONNETTORE POSTERIORE AMP 1.5 REAR-LIGHT 5 FUNCTIONS - REAR CONNECTOR AMP 1.5 COS.PEL. ref. SIMILAR ref. 1501.03000 4421266 / 5001870556 DX RH (ex 007880/007900) - Connettore 003120 1501.03001 4421265 / 7485118470 SX LH Con luce targa / W. plate light (ex 007880/007900) - Conn. 003120 TRASPARENTE / LENS 1501.03100 5001847153 (ex 011591) DX-SX RH-LH</p>



	<p>PARAURTI ANTERIORE P.P. - NERO FRONT BUMPER P.P. - BLACK</p> <p>COS.PEL. ref. SIMILAR ref. 401.80700 7700376750</p>
	<p>VETRO SPECCHIO (253x151mm) MIRROR GLASS (253x151mm)</p> <p>COS.PEL. ref. SIMILAR ref. 501.28236 7701028236</p> <p style="text-align: right;">DX-SX RH-LH</p>
<p>AD ESAURIMENTO SCORTE UNTIL SELL-OUT</p> 	<p>ALZACRISTALLI ELETTRICO - CON MOTORINO - 6 PIN WINDOW REGULATOR ELECTRIC - WITH MOTOR - 6 PIN</p> <p>COS.PEL. ref. SIMILAR ref. 1901.00500 8200162710</p> <p style="text-align: right;">DX RH</p>
	<p>KIT PER CONNESSIONI ELETTRICHE Connettore AMP 1,5 singolo KIT FOR ELECTRICAL JOINTS Connector AMP 1,5 simple</p> <p>COS.PEL. ref. SIMILAR ref. 003120 -</p>
	<p>FANALE POSTERIORE 5 FUNZIONI - CONNETTORE POSTERIORE AMP 1.5 REAR-LIGHT 5 FUNCTIONS - REAR CONNECTOR AMP 1.5</p> <p>COS.PEL. ref. SIMILAR ref. 1501.03000 4421266 / 5001870556 DX RH (ex 007880/007900) - Connettore 003120 1501.03001 4421265 / 7485118470 SX LH Con luce targa / W. plate light (ex 007880/007900) - Conn. 003120 TRASPARENTE / LENS 1501.03100 5001847153 (ex 011591) DX-SX RH-LH</p>



<p>AD ESAURIMENTO SCORTE UNITS SELL-OUT</p> 	<p>VETRO SPECCHIO (344x163mm) MIRROR GLASS (344x163mm)</p> <p>COS.PEL. ref. SIMILAR ref. 501.36341 5000336341</p> <p style="text-align: right;">DX-SX RH-LH</p>
---	---











<p>AD ESAURIMENTO SCORTE UNTR. STYL-OUT.</p> 	<p>VETRO SPECCHIO RISCALDATO - (400x204mm) MIRROR GLASS HEATED - (400x204mm)</p> <p>COS.PEL. ref. SIMILAR ref. 501.05326 5000805326</p> <p style="text-align: right;">DX-SX RH-LH</p>
--	---



	<p>GRIGLIA FRONTALE A.B.S. - NERO FRONT GRILLE A.B.S. - BLACK</p> <p>COS.PEL. ref. SIMILAR ref. 101.53101 5010578888</p>
	<p>PEDANA P.P.G.F. - GRIGIO SCURO FOOTSTEP P.P.G.F. - DARK GREY</p> <p>COS.PEL. ref. SIMILAR ref. 301.53000 5010353496 DX RH</p> <p>301.53001 Griglia/Grille : 1001.53100 5010353495 SX LH</p> <p>Griglia/Grille : 1001.53101</p>
	<p>PEDANA P.P. - GRIGIO CHIARO FOOTSTEP P.P. - GREY</p> <p>COS.PEL. ref. SIMILAR ref. 301.53002 5010468440 DX RH</p> <p>301.53003 Griglia/Grille : 1001.53105 Sup - 1001.53106 Inf 5010468439 SX LH</p> <p>Griglia/Grille : 1001.53105 Sup - 1001.53106 Inf</p>
	<p>PARAURTI ANTERIORE P.P.G.F. - PRIMER - SENZA FORI FENDI FRONT BUMPER P.P.G.F. - PRIMER - WITHOUT HOLES</p> <p>COS.PEL. ref. SIMILAR ref. 401.53306 5010623869</p>
	<p>PARAURTI ANTERIORE P.P.G.F. - PRIMER - CON FORI FENDI FRONT BUMPER P.P.G.F. - PRIMER - WITH HOLES</p> <p>COS.PEL. ref. SIMILAR ref. 401.53307 5010623868</p>

 <p>cm 17</p>	<p>PARAURTI ANTERIORE P.P.G.F. - GRIGIO SCURO - CON FORI FENDINEBBIA FRONT BUMPER P.P.G.F. - DARK GREY - W/FOG LAMP HOLES</p> <p>COS.PEL. ref. SIMILAR ref. 401.53308 5010544308 / 5010623868</p>
 <p>cm 17</p>	<p>PARAURTI ANTERIORE P.P.G.F. - GRIGIO SCURO - SENZA FORI FENDINEBBIA FRONT BUMPER P.P.G.F. - DARK GREY - W/O FOG LAMP HOLES</p> <p>COS.PEL. ref. SIMILAR ref. 401.53309 5010544309 / 5010623869</p>
 <p>cm 23</p>	<p>PARAURTI ANTERIORE P.P.G.F. - GRIGIO SCURO - SENZA FORI FENDINEBBIA FRONT BUMPER P.P.G.F. - DARK GREY - W/O FOG LAMP HOLES</p> <p>COS.PEL. ref. SIMILAR ref. 401.53310 5010544070</p>
 <p>cm 23</p>	<p>PARAURTI ANTERIORE P.P.G.F. - GRIGIO SCURO - SENZA FORI FENDINEBBIA FRONT BUMPER P.P.G.F. - DARK GREY - W/O FOG LAMP HOLES</p> <p>COS.PEL. ref. SIMILAR ref. 401.53311 5010544069</p>
 <p>cm 23</p>	<p>PARAURTI ANTERIORE P.P.G.F. - PRIMER - SENZA FORI FENDINEBBIA FRONT BUMPER P.P.G.F. - PRIMER - W/O FOG LAMP HOLES</p> <p>COS.PEL. ref. SIMILAR ref. 401.53312 5010623890</p>
 <p>cm 23</p>	<p>PARAURTI ANTERIORE P.P.G.F. - PRIMER - CON FORI FENDINEBBIA FRONT BUMPER P.P.G.F. - PRIMER - WITH FOG LAMP HOLES</p> <p>COS.PEL. ref. SIMILAR ref. 401.53313 5010623889</p>
	<p>GRIGLIA PARAURTI FRONT BUMPER GRILLE</p> <p>COS.PEL. ref. SIMILAR ref. 401.53314 5010353105 DX RH</p> <p>401.53315 5010353104 SX LH</p>
	<p>GRIGLIA PARAURTI SUPERIORE UPPER FRONT BUMPER GRILLE</p> <p>COS.PEL. ref. SIMILAR ref. 401.53316 5010468538</p>

	<p>GRIGLIA PARAURTI INFERIORE FRONT BUMPER GRILLE LOWER</p> <p>COS.PEL. ref. 401.53317 SIMILAR ref. 5010468537</p>
	<p>SPECCHIO RETROVISORE FRONTALE FRONT REAR-VIEW MIRROR</p> <p>COS.PEL. ref. 501.30420 SIMILAR ref. 7420849837 / 7482226025 DX-SX RH-LH</p>
	<p>SPECCHIO RETROVISORE MANUALE - RISCALDATO REAR-VIEW MIRROR MANUAL - HEATED</p> <p>COS.PEL. ref. 501.53500 SIMILAR ref. 5001856292 DX-SX RH-LH</p>
	<p>SPECCHIO RETROVISORE MANUALE - RISCALDATO REAR-VIEW MIRROR MANUAL - HEATED</p> <p>COS.PEL. ref. 501.53501 SIMILAR ref. 7421276373 DX-SX RH-LH</p>
 <p>cm 193 cm 50</p>	<p>VISIERA CON STAFFE - SENZA SPECCHIO FRONTALE SUN VISOR WITH BRACKETS</p> <p>COS.PEL. ref. 701.53100 SIMILAR ref. 7420937430</p>
 <p>cm 194 cm 28</p>	<p>VISIERA TETTO BASSO CON SPECCHIO FRONTALE LOW ROOF SUN VISION WITH FRONT MIRROR</p> <p>COS.PEL. ref. 701.53104 SIMILAR ref. 5010353843 Relativo kit staffe 1001.53104</p>
	<p>CONVOGLIATORE ARIA AIR CONVEYOR</p> <p>COS.PEL. ref. 901.25600 SIMILAR ref. 5010578660 / 5010578667 DX RH 901.25601 5010578659 / 5010578661 SX LH</p>
	<p>SUPPORTO PARAURTI (TIPO BASSO) METALLO - NERO BUMPER SUPPORT (LOW TYPE) METAL - BLACK</p> <p>COS.PEL. ref. 1001.53097 SIMILAR ref. 5010588488</p>

	<p>SUPPORTO PARAURTI (TIPO ALTO) METALLO - NERO - ESTERNO BUMPER SUPPORT (HIGH TYPE) METAL - BLACK - EXTERNAL</p> <p>COS.PEL. ref. SIMILAR ref. 1001.53098 5010417802</p>
	<p>SUPPORTO PARAURTI (TIPO ALTO) METALLO - NERO - INTERNO BUMPER SUPPORT (HIGH TYPE) METAL - BLACK - INNER</p> <p>COS.PEL. ref. SIMILAR ref. 1001.53099 5010417132</p>
	<p>GRIGLIA PEDANA INFERIORE P.P.G.F. - NERA LOWER FOOTSTEP GRILLE P.P.G.F. - BLACK</p> <p>COS.PEL. ref. SIMILAR ref. 1001.53100 5010544027 DX RH</p> <p>1001.53101 5010544026 SX LH</p>
	<p>GRIGLIA PEDANA INFERIORE / SUPERIORE ALLUMINIO LOWER / UPPER FOOTSTEP GRILLE ALUMINIUM</p> <p>COS.PEL. ref. SIMILAR ref. 1001.53105 5010468441 DX-SX RH-LH</p>
	<p>PORTALAMPADA Relativo connettore 003121 LAMP BULB HOLDER Related connector 003121</p> <p>COS.PEL. ref. SIMILAR ref. 1601.50015 5001834568</p> <p>Per lampada / For lamp : 1601.50018 / 1604.55001</p>
 	<p>FANALINO LATERALE R5W SIDE LAMP R5W</p> <p>COS.PEL. ref. SIMILAR ref. 1601.50018 5001834565 / 7421103284 DX-SX RH-LH</p> <p>Portalampada/Lamp holder : 1601.50015</p>
 	<p>PROIETTORE CON CORNICE H1/W5W - CORRETTORE ASSETTO MANUALE HEADLAMP WITH FRAME H1/W5W - MANUAL LOAD LEVEL ADJUSTEMENT</p> <p>COS.PEL. ref. SIMILAR ref. 1601.53600 5010468981 DX RH</p> <p>1601.53601 5010468980 SX LH</p>
	<p>MANIGLIA PORTA SENZA CHIAVE DOOR HANDLE WITHOUT KEY</p> <p>COS.PEL. ref. SIMILAR ref. 1701.53600 5001858130 DX RH</p> <p>1701.53601 5001858129 SX LH</p>

	<p>CERNIERA A.B.S. - NERO HINGE A.B.S. - BLACK</p> <p>COS.PEL. ref. SIMILAR ref. 1701.53616 5010468880</p> <p style="text-align: right;">DX-SX RH-LH</p>
	<p>GUARNIZIONE PARABREZZA WINDSCREEN GASKET</p> <p>COS.PEL. ref. SIMILAR ref. 1801.53000 5010220975</p>
	<p>MOLLA A GAS Lunghezza [mm] 705 Corsa [mm] 280 Forza scarto [N] 250 GAS SPRING Lenght [mm] 705 Stroke [mm] 280 Waste force [N] 250</p> <p>COS.PEL. ref. SIMILAR ref. 2401.53100 5010468464</p>
	<p>MOLLA A GAS Lunghezza [mm] 590 Corsa [mm] 250 Forza scarto [N] 235 GAS SPRING Lenght [mm] 590 Stroke [mm] 250 Waste force [N] 235</p> <p>COS.PEL. ref. SIMILAR ref. 2401.53101 5010623108</p>
	<p>DEFLETTORI LATERALI CON CLIPS SIDEWINDOW DEFLECTORS WITH CLIPS</p> <p>COS.PEL. ref. SIMILAR ref. 3002.00002 -</p>
	<p>KIT PER CONNESSIONI ELETTRICHE Connettore AMP 1,5 singolo KIT FOR ELECTRICAL JOINTS Connector AMP 1,5 simple</p> <p>COS.PEL. ref. SIMILAR ref. 003120 -</p>
	<p>KIT PER CONNESSIONI ELETTRICHE Connettore 3 vie JPT KIT FOR ELECTRICAL JOINTS Connector 3 ways JPT</p> <p>COS.PEL. ref. SIMILAR ref. 003121 -</p> <p style="text-align: right;">Connettore per 1601.50015</p>
	<p>FANALE POSTERIORE 5 FUNZIONI - CONNETTORE POSTERIORE AMP 1.5 REAR-LIGHT 5 FUNCTIONS - REAR CONNECTOR AMP 1.5</p> <p>COS.PEL. ref. SIMILAR ref. 1501.03000 4421266 / 5001870556 DX RH (ex 007880/007900) - Connettore 003120 1501.03001 4421265 / 7485118470 SX LH Con luce targa / W. plate light (ex 007880/007900) - Conn. 003120 TRASPARENTE / LENS 1501.03100 5001847153 (ex 011591) DX-SX RH-LH</p>



<p>AD ESAURIMENTO SCORTE UNTIL SELL-OUT</p> 	<p>CALANDRA S.M.C. FRONT PANEL S.M.C.</p> <p>COS.PEL. ref. SIMILAR ref. 101.01971 5010301971</p>
	<p>GRIGLIA CENTRALE A.B.S. - NERO CENTRAL GRILLE A.B.S. - BLACK</p> <p>COS.PEL. ref. SIMILAR ref. 101.01972 5010225061 / 5010578522</p>
	<p>CALOTTA PARAF. POSTER. R 3a SERIE CON 4 TIRANTI P.P. - NERO - 12-04 REAR MUDGUARD 3RD SERIES WITH 4 M. TENSIONERS P.P. - BLACK - 12-04</p> <p>COS.PEL. ref. SIMILAR ref. 201.14950 5001856184 / 5010314951 DX-SX RH-LH</p> <p>(201.14951 versione senza i tiranti)</p>
	<p>CALOTTA PARAFANGO POSTERIORE P.P. - NERO - 12-04 - 3a serie REAR MUDGUARD P.P. - BLACK - 12-04 - 3rd series</p> <p>COS.PEL. ref. SIMILAR ref. 201.14951 5010314951 DX-SX RH-LH</p> <p>Tirante : 1001.14951 - (201.14950 versione con i tiranti)</p>
	<p>CALOTTA PARAFANGO POSTERIORE P.P. - NERO - 01-00 > 12-03 - 4a serie REAR MUDGUARD P.P. - BLACK - 01-00 > 12-03 - 4th series</p> <p>COS.PEL. ref. SIMILAR ref. 201.14952 5010314952 DX-SX RH-LH</p> <p>Tirante : 1001.14951 - (201.14953 versione con i tiranti)</p>

ALL ITEMS MENTIONED IN OUR CATALOGUE ARE NOT ORIGINAL PARTS BUT PERFECTLY INTERCHANGEABLE WITH THEM.









GOVERNING LEGISLATIONS FOR THE SALE OF OUR PRODUCTS DIFFER IN EACH COUNTRY.

INFRINGEMENTS, IF ANY, OF LOCAL LEGISLATIONS ARE RESPONSIBILITY OF THE RETAILER IN THE COUNTRY OF FINAL DISTRIBUTION.



Premium

	<p>CALOTTA PARAF. POST. R 4a S. CORTA CON 4 TIRANTI P.P. - NERO - 01-00 > 12-03 REAR MUDGUARD 4RD SERIES WITH 4 M. TENSIONERS P.P. - BLACK - 01-00 > 12-03</p> <p>COS.PEL. ref. SIMILAR ref. 201.14953 5001856184 / 5010314952 DX-SX RH-LH</p> <p>(201.14952 versione senza i tiranti)</p>
	<p>MEZZO PARAFANGO POSTERIORE P.P. - NERO - CON STAFFE REAR MUDGUARD P.P. - BLACK - WITH BRACKETS</p> <p>COS.PEL. ref. SIMILAR ref. 201.28252 5010228158 DX-SX RH-LH</p>
	<p>CALOTTA PARAFANGO POSTERIORE P.P. - NERO - 12-00 - 2a serie REAR MUDGUARD P.P. - BLACK - 12-00 - 2nd series</p> <p>COS.PEL. ref. SIMILAR ref. 201.28253 5010228253 DX-SX RH-LH</p> <p>Tirante : 1001.00001 - (201.28254 versione con i tiranti)</p>
	<p>CALOTTA PARAF. POSTER. 2a SERIE CON 4 TIRANTI P.P. - NERO - 12-00 REAR MUDGUARD 2ND SERIES WITH 4 M. TENSIONERS P.P. - BLACK - 12-00</p> <p>COS.PEL. ref. SIMILAR ref. 201.28254 5001842757 / 5010228253 DX-SX RH-LH</p> <p>(201.28253 versione senza i tiranti)</p>
	<p>MEZZO PARAFANGO POSTERIORE (PARTE POSTERIORE) CON STAFFE REAR MUDGUARD (REAR PART) WITH BRACKETS</p> <p>COS.PEL. ref. SIMILAR ref. 201.28255 5001856195 DX-SX RH-LH</p>
	<p>MEZZO PARAFANGO POSTERIORE (PARTE ANTERIORE) CON STAFFE REAR MUDGUARD (FRONT PART) WITH BRACKETS</p> <p>COS.PEL. ref. SIMILAR ref. 201.28256 5010314953 DX-SX RH-LH</p>
	<p>CALOTTA PARAF. POSTER. R 1a SERIE CON 4 TIRANTI A.B.S. - NERO - 12-99 REAR MUDGUARD 1ST SERIES WITH 4 M. TENSIONERS A.B.S. - BLACK - 12-99</p> <p>COS.PEL. ref. SIMILAR ref. 201.32440 5001823641 / 5010132441 DX-SX RH-LH</p> <p>(201.32441 versione senza i tiranti)</p>
	<p>CALOTTA PARAFANGO POSTERIORE A.B.S. - NERO - 12-99 - 1a serie REAR MUDGUARD A.B.S. - BLACK - 12-99 - 1st series</p> <p>COS.PEL. ref. SIMILAR ref. 201.32441 5010132441 DX-SX RH-LH</p> <p>Tirante : 1001.23641 - (201.32440 versione con i tiranti)</p>











	<p>RIPARO PEDANA H.D.P.E. - NERO FOOTSTEP PROTECTION H.D.P.E. - BLACK COS.PEL. ref. SIMILAR ref. 301.30006 5010225405 / 5010578396 DX RH</p> <p>301.30005 5010225404 / 5010578395 SX LH</p>
	<p>PEDANA PARAFANGO P.P.G.F. - PRIMER MUDGUARD FOOTSTEP P.P.G.F. - PRIMER COS.PEL. ref. SIMILAR ref. 301.30008 5010353004 / 5010468636 DX RH</p> <p>301.30007 Griglia/Grille 1001.53102 5010353003 / 5010468635 SX LH Griglia/Grille 1001.53103</p>
	<p>PEDANA P.P.G.F. - GRIGIO SCURO FOOTSTEP P.P.G.F. - DARK GREY COS.PEL. ref. SIMILAR ref. 301.00002 5010225722 / 7421304660 DX RH</p> <p>301.00001 Griglia/Grille: 1001.53100 inf - 1001.53102 sup 5010225068 / 7421304658 SX LH Griglia/Grille: 1001.53101 inf - 1001.53103 sup</p>
	<p>PARAURTI ANTERIORE SENZA SPOILER S.M.C. - GRIGIO SCURO FRONT BUMPER W/O SPOILER S.M.C. - DARK GREY COS.PEL. ref. SIMILAR ref. 401.25813 5010225813</p>
	<p>PARAURTI ANTERIORE S.M.C. - GRIGIO SCURO FRONT BUMPER S.M.C. - DARK GREY COS.PEL. ref. SIMILAR ref. 401.25815 5010225815</p>
	<p>PARAURTI ANTERIORE SENZA SPOILER S.M.C. - GRIGIO SCURO FRONT BUMPER W/O SPOILER S.M.C. - DARK GREY COS.PEL. ref. SIMILAR ref. 401.25817 5010225817</p>
	<p>PARAURTI ANTERIORE S.M.C. - GRIGIO SCURO FRONT BUMPER S.M.C. - DARK GREY COS.PEL. ref. SIMILAR ref. 401.25819 5010225819</p>
	<p>TAPPO PARAURTI P.P. - GRIGIO COVER BUMPER P.P. - GREY COS.PEL. ref. SIMILAR ref. 401.25812 5010225822 DX RH</p> <p>401.25811 5010225821 SX LH</p>

Premium

	<p>GRIGLIA PARAURTI SUPERIORE UPPER BUMPER GRILLE</p> <p>COS.PEL. ref. 401.25820 SIMILAR ref. 5010301143</p>
	<p>GRIGLIA PARAURTI INFERIORE LOWER BUMPER GRILLE</p> <p>COS.PEL. ref. 401.25821 SIMILAR ref. 5010301144</p>
	<p>VETRO SPECCHIO RISCALDATO - (373x183 mm) MIRROR GLASS HEATED - (373x183 mm)</p> <p>COS.PEL. ref. 501.32947 SIMILAR ref. 5001832947</p> <p style="text-align: right;">DX-SX RH-LH</p>
	<p>VETRO SPECCHIO GRANDANGOLO - RISCALDATO - (180x180 mm) MIRROR GLASS WIDE ANGLE - HEATED - (180x180 mm)</p> <p>COS.PEL. ref. 501.32948 SIMILAR ref. 5001832948 / 7421276373</p> <p style="text-align: right;">DX RH</p>
	<p>SPECCHIO RETROVISORE ELETTRICO - RISCALDATO REAR-VIEW MIRROR ELECTRIC - HEATED</p> <p>COS.PEL. ref. 501.56290 SIMILAR ref. 5001856290</p> <p style="text-align: right;">DX-SX RH-LH</p>
	<p>VISIERA KERAX - PREMIUM SUN VISOR KERAX - PREMIUM</p> <p>COS.PEL. ref. 701.25100 SIMILAR ref. 7420937446</p> <p style="text-align: right;">Relativo kit staffe 1001.25100</p>
	<p>VISIERA PREMIUM TETTO ALTO 1a serie SUN VISOR PREMIUM HIGH CAB 1st series</p> <p>COS.PEL. ref. 701.25600 SIMILAR ref. 5001850374</p> <p style="text-align: right;">Relativo kit staffe 1001.25600</p>
<p>AD ESAURIMENTO SCORTE UNTIL SKILL-OUT</p> 	<p>CARENATURA ANTERIORE G.R.P. - BIANCO - (PASSO 3650mm) FRONT FAIRING G.R.P. - WHITE - (WHEEL BASE 3650mm)</p> <p>COS.PEL. ref. 801.10002 SIMILAR ref. 5021012002</p> <p style="text-align: right;">DX RH</p>

<p>AD ESAURIMENTO SCORTE UNTIL SELL-OUT</p>  <p>cm 310</p> <p>cm 74</p>	<p>CARENATURA ANTERIORE G.R.P. - BIANCO - (PASSO 3815mm) FRONT FAIRING G.R.P. - WHITE - (WHEEL BASE 3815mm)</p> <p>COS.PEL. ref. SIMILAR ref. 801.10101 -</p> <p style="text-align: right;">SX LH</p>
<p>AD ESAURIMENTO SCORTE UNTIL SELL-OUT</p>  <p>cm 223</p> <p>cm 74</p>	<p>CARENATURA POSTERIORE G.R.P. - BIANCO - (PASSO 3815mm) REAR FAIRING G.R.P. - WHITE - (WHEEL BASE 3815mm)</p> <p>COS.PEL. ref. SIMILAR ref. 801.10104 -</p> <p style="text-align: right;">DX RH</p>
<p>AD ESAURIMENTO SCORTE UNTIL SELL-OUT</p> 	<p>DEFLETTORE CABINA ALTA 1a serie G.R.P. - BIANCO DEFLECTOR HIGH CAB 1st series G.R.P. - WHITE</p> <p>COS.PEL. ref. SIMILAR ref. 801.53020 5010544660 / 5010544664</p> <p>801.53021 5010544648 / 5010544653</p> <p style="text-align: right;">DX RH SX LH</p>
	<p>PANNELLO ANGOLARE CORNER PANEL</p> <p>COS.PEL. ref. SIMILAR ref. 901.50000 5010445662</p> <p>901.50001 5010445661</p> <p style="text-align: right;">DX RH SX LH</p>
	<p>STAFFA PEDANA METALLO - NERO FOOTSTEP BRACKET METAL - BLACK</p> <p>COS.PEL. ref. SIMILAR ref. 1001.00011 7482962977</p>
	<p>COPRI BATTERIE P.P. + EPDM - GRIGIO BATTERY COVER P.P. + EPDM - GREY</p> <p>COS.PEL. ref. SIMILAR ref. 1001.00015 5010505041</p>
	<p>SUPPORTO PEDANA ALLUMINIO FOOTSTEP MOUNTING BRACKET ALUMINIUM</p> <p>COS.PEL. ref. SIMILAR ref. 1001.00016 5010610723 / 7421087113</p> <p style="text-align: right;">DX-SX RH-LH</p>
	<p>GRIGLIA PEDANA INFERIORE P.P.G.F. - NERA LOWER FOOTSTEP GRILLE P.P.G.F. - BLACK</p> <p>COS.PEL. ref. SIMILAR ref. 1001.53100 5010544027</p> <p>1001.53101 5010544026</p> <p style="text-align: right;">DX RH SX LH</p>

Premium

	<p>GRIGLIA PEDANA SUPERIORE / INFERIORE P.P.G.F. - NERA UPPER / LOWER FOOTSTEP GRILLE P.P.G.F. - BLACK COS.PEL. ref. SIMILAR ref. 1001.53102 5010544030 DX RH</p> <p>1001.53103 5010544029 SX LH</p>
	<p>COLLARE DI FISSAGGIO PARAFANGO METALLO BRACKET MUDGUARD METAL COS.PEL. ref. SIMILAR ref. 1006.33602 5001833310</p>
	<p>CORNICE FARO A.B.S. - GRIGIO HEADLAMP FRAME A.B.S. - GREY COS.PEL. ref. SIMILAR ref. 1101.50010 5001834442 DX RH</p> <p>1101.50011 5001834444 SX LH</p>
 	<p>FANALE LATERALE LAMPADINA ATTACCO AMP - JPT - Relativo connettore 003122 SIDE LAMP BULB CONNECTION AMP - JPT - Related connector 003122 COS.PEL. ref. SIMILAR ref. 003001 5010306792 / 7484538758 DX-SX RH-LH</p> <p>ARANCIO / ORANGE - Relativo portalampada 1601.50013</p>
 	<p>FANALE LATERALE LAMPADINA ATTACCO AMP-JPT - W5W - Relativo connettore 003122 SIDE LAMP BULB CONNECTION AMP-JPT - W5W - Relativo connettore 003122 COS.PEL. ref. SIMILAR ref. 003003 5001862030 DX-SX RH-LH</p> <p>BIANCO / WHITE - Relativo portalampada 1601.50013</p>
 	<p>FANALE LATERALE LED 4 LED - 12 / 24 Volt - Relativo connettore 003122 SIDE LAMP LED 4 LED - 12 / 24 Volt - Relativo connettore 003122 COS.PEL. ref. SIMILAR ref. 003004 - DX-SX RH-LH</p> <p>BIANCO / WHITE (12/24 V) - Relativo portalampada 1601.50013</p>
	<p>PORTALAMPADA Relativo connettore 003122 (JPT) LAMP BULB HOLDER Related connector 003122 (JPT) COS.PEL. ref. SIMILAR ref. 1601.50013 5001847589</p> <p>Per lampada / For lamp : 003001 / 003003 / 003004</p>
	<p>PORTALAMPADA Relativo connettore 003122 LAMP BULB HOLDER Related connector 003122 COS.PEL. ref. SIMILAR ref. 1601.50014 5001834564</p> <p>Per lampada / For lamp : 1601.50021/2</p>

	<p>PORTALAMPADA Relativo connettore 003121 LAMP BULB HOLDER Related connector 003121</p> <p>COS.PEL. ref. SIMILAR ref. 1601.50015 5001834568</p> <p>Per lampada / For lamp : 1601.50018 / 1604.55001</p>
 	<p>FANALINO LATERALE R5W SIDE LAMP R5W</p> <p>COS.PEL. ref. SIMILAR ref. 1601.50018 5001834565 / 7421103284 DX-SX RH-LH</p> <p>Portalampada/Lamp holder : 1601.50015</p>
 	<p>INDICATORE DIREZIONE P21W DIRECTION INDICATOR P21W</p> <p>COS.PEL. ref. SIMILAR ref. 1601.50022 5001834559 DX RH</p> <p>1601.50021 5001834560 SX LH</p> <p>Portalampada/Lamp holder : 1601.50014 Portalampada/Lamp holder : 1601.50014</p>
 	<p>PROIETTORE CON CORNICE H1/W5W - CORRETTORE ASSETTO MANUALE HEADLAMP WITH FRAME H1/W5W - MANUAL LOAD LEVEL ADJUSTEMENT</p> <p>COS.PEL. ref. SIMILAR ref. 1601.50016 5010468981 DX RH</p> <p>1601.50017 5010468980 SX LH</p>
 	<p>PROIETTORE H1/W5W - CORRETTORE ASSETTO MANUALE HEADLAMP H1/W5W - MANUAL LOAD LEVEL ADJUSTEMENT</p> <p>COS.PEL. ref. SIMILAR ref. 1601.50020 5001840475 DX RH</p> <p>1601.50019 5001840476 SX LH</p>
 	<p>PROIETTORE FENDINEBBIA H1 FOG LAMP H1</p> <p>COS.PEL. ref. SIMILAR ref. 1601.50024 5010231850 DX RH</p> <p>1601.50023 5010231849 SX LH</p>
 	<p>PROIETTORE H1/W5W - CON CORNICE - ELETTRICO SENZA MOTORINO HEADLAMP H1/W5W - WITH FRAME - ELECTRIC W/O MOTOR</p> <p>COS.PEL. ref. SIMILAR ref. 1601.50026 5010231670 DX RH</p> <p>1601.50027 5010231669 SX LH</p>
	<p>MANIGLIA PORTA SENZA CHIAVE DOOR HANDLE WITHOUT KEY</p> <p>COS.PEL. ref. SIMILAR ref. 1701.53600 5001858130 DX RH</p> <p>1701.53601 5001858129 SX LH</p>

Premium

	<p>MANIGLIA PORTA CON CHIAVE DOOR HANDLE WITH KEY</p> <p>COS.PEL. ref. SIMILAR ref. 1701.53602 5001858130 + 5001834847</p> <p>1701.53603 5001858129 + 5001834847</p> <p style="text-align: right;">DX RH</p> <p style="text-align: right;">SX LH</p>
	<p>MANIGLIA PORTA INTERNA FRONT DOOR HANDLE INSIDE</p> <p>COS.PEL. ref. SIMILAR ref. 1701.53604 -</p> <p>1701.53605 -</p> <p style="text-align: right;">DX RH</p> <p style="text-align: right;">SX LH</p>
	<p>MANIGLIA PORTA INTERNA INSIDE DOOR HANDLE</p> <p>COS.PEL. ref. SIMILAR ref. 1701.53606 5010220068</p> <p>1701.53607 5010220067</p> <p style="text-align: right;">DX RH</p> <p style="text-align: right;">SX LH</p>
	<p>SERRATURA PORTA DOOR LOCK</p> <p>COS.PEL. ref. SIMILAR ref. 1701.53610 20864258 / 7420864258</p> <p style="text-align: right;">DX RH</p>
	<p>GUARNIZIONE PARABREZZA WINDSCREEN GASKET</p> <p>COS.PEL. ref. SIMILAR ref. 1801.73000 5010220413</p>
	<p>TIRANTE PARAFANGO POSTERIORE GOMMA - NERO MUDGUARD TENSIONER RUBBER - BLACK</p> <p>COS.PEL. ref. SIMILAR ref. 1001.00001 5001842757</p>
	<p>TIRANTE CALOTTA 3a SERIE GOMMA - NERO MUDGUARD TENSIONER 3rd SERIES RUBBER - BLACK</p> <p>COS.PEL. ref. SIMILAR ref. 1001.14951 5001856184</p>
	<p>TIRANTE PARAFANGO POSTERIORE GOMMA - NERO MUDGUARD TENSIONER 1st SERIES RUBBER - BLACK</p> <p>COS.PEL. ref. SIMILAR ref. 1001.23641 5001823641</p>

	<p>MOLLA A GAS Lunghezza [mm] 635 Corsa [mm] 270 Forza scarto [N] 350 GAS SPRING Lenght [mm] 635 Stroke [mm] 270 Waste force [N] 350</p> <p>COS.PEL. ref. SIMILAR ref. 2401.50100 5010225922</p>
	<p>MOLLA A GAS Lunghezza [mm] 645 Corsa [mm] 280 Forza scarto [N] 350 GAS SPRING Lenght [mm] 645 Stroke [mm] 280 Waste force [N] 350</p> <p>COS.PEL. ref. SIMILAR ref. 2401.50101 5010353702</p>
	<p>KIT PER CONNESSIONI ELETTRICHE Connettore 3 vie JPT KIT FOR ELECTRICAL JOINTS Connector 3 ways JPT</p> <p>COS.PEL. ref. SIMILAR ref. 003121 -</p> <p>Connettore per 1601.50015</p>
	<p>KIT PER CONNESSIONI ELETTRICHE Connettore 2 vie JPT KIT FOR ELECTRICAL JOINTS Connector 2 ways JPT</p> <p>COS.PEL. ref. SIMILAR ref. 003122 -</p> <p>Connettore per 003001 - 003003 - 003004</p>
 <p>cm 15,5</p>	<p>FANALE POSTERIORE 7 FUNZIONI REAR-LIGHT 7 FUNCTIONS</p> <p>COS.PEL. ref. SIMILAR ref. 006120 5001847587 DX RH Relativo connettore 003120 006130 5001847584 SX LH Con luce targa / With plate light - conn. 003120 TRASPARENTE / LENS 011111 5000296594 DX-SX RH-LH</p>
 <p>cm 15,5</p>	<p>FANALE POSTERIORE LED REAR LIGHTING LED LED</p> <p>COS.PEL. ref. SIMILAR ref. 006122 - DX RH Relativo connettore 003120 006121 - SX LH Con luce targa / With plate light - conn. 003120 TRASPARENTE / LENS 011112 - DX-SX RH-LH</p>
 <p>cm 15,5</p>	<p>FANALE POSTERIORE 7 FUNZIONI - SENZA LUCE TARGA REAR-LIGHT 7 FUNCTIONS - WITHOUT PLATE LIGHT</p> <p>COS.PEL. ref. SIMILAR ref. 006131 5001847584 / 5001847586 SX LH Relativo connettore 003120 TRASPARENTE / LENS 011111 5000296594 DX-SX RH-LH</p>
 <p>cm 15,2</p>	<p>FANALE POSTERIORE 7 FUNZIONI REAR-LIGHT 7 FUNCTIONS</p> <p>COS.PEL. ref. SIMILAR ref. 1504.10500 5001847587 DX RH Relativo connettore 003120 1504.10501 5001847584 SX LH Con luce targa / With plate light - conn. 003120 TRASPARENTE / LENS 011111 5000296594 DX-SX RH-LH</p>



	<p>GRIGLIA FRONTALE A.B.S. - NERO FRONT GRILLE A.B.S. - BLACK</p> <p>COS.PEL. ref. SIMILAR ref. 101.25101 5010578630</p>
	<p>PEDANA P.P.G.F. - GRIGIO SCURO FOOTSTEP P.P.G.F. - DARK GREY</p> <p>COS.PEL. ref. SIMILAR ref. 301.25240 5010225393 DX RH</p> <p>301.25241 Griglia/Grille : 1001.53102 SX LH 5010225392 Griglia/Grille : 1001.53103</p>
	<p>PEDANA SUPPLEMENTARE ADDITIONAL FOOTSTEP</p> <p>COS.PEL. ref. SIMILAR ref. 301.25242 7420870164 DX-SX RH-LH</p>
	<p>PEDANA INFERIORE LOWER FOOTSTEP</p> <p>COS.PEL. ref. SIMILAR ref. 301.25243 5010367075 DX-SX RH-LH</p>
	<p>ANGOLO PARAURTI METALLO - NERO CORNER BUMPER METAL - BLACK</p> <p>COS.PEL. ref. SIMILAR ref. 401.25090 5010225411 / 7482584431 DX-SX RH-LH</p>

	<p>PEDANA PARAURTI P.P. - NERO BUMPER STEP P.P. - BLACK</p> <p>COS.PEL. ref. SIMILAR ref. 401.25091 5010301249 / 7420980740</p>
	<p>PARAURTI ANTERIORE METALLO FRONT BUMPER METAL</p> <p>COS.PEL. ref. SIMILAR ref. 401.25092 5010628893 / 7482491182</p>
	<p>SPECCHIO RETROVISORE FRONTALE FRONT REAR-VIEW MIRROR</p> <p>COS.PEL. ref. SIMILAR ref. 501.30420 7420849837 / 7482226025 DX-SX RH-LH</p>
	<p>SPECCHIO RETROVISORE MANUALE - RISCALDATO REAR-VIEW MIRROR MANUAL - HEATED</p> <p>COS.PEL. ref. SIMILAR ref. 501.53500 5001856292 DX-SX RH-LH</p>
	<p>SPECCHIO RETROVISORE MANUALE - RISCALDATO REAR-VIEW MIRROR MANUAL - HEATED</p> <p>COS.PEL. ref. SIMILAR ref. 501.53501 7421276373 DX-SX RH-LH</p>
 <p>cm 213 cm 54</p>	<p>VISIERA KERAX - PREMIUM SUN VISOR KERAX - PREMIUM</p> <p>COS.PEL. ref. SIMILAR ref. 701.25100 7420937446</p> <p>Relativo kit staffe 1001.25100</p>
	<p>CONVOGLIATORE ARIA AIR CONVEYOR</p> <p>COS.PEL. ref. SIMILAR ref. 901.25600 5010578660 / 5010578667 DX RH</p> <p>901.25601 5010578659 / 5010578661 SX LH</p>
	<p>COPRI BATTERIE S.M.C. - NERO BATTERY COVER S.M.C. - BLACK</p> <p>COS.PEL. ref. SIMILAR ref. 1001.25101 5010314693</p>

	<p>SUPPORTO PEDANA ALLUMINIO FOOTSTEP MOUNTING BRACKET ALUMINIUM</p> <p>COS.PEL. ref. SIMILAR ref. 1001.25102 5010610556</p> <p style="text-align: right;">DX-SX RH-LH</p>
	<p>SUPPORTO PEDANA ALLUMINIO FOOTSTEP MOUNTING BRACKET ALUMINIUM</p> <p>COS.PEL. ref. SIMILAR ref. 1001.25103 5010634248</p> <p style="text-align: right;">DX-SX RH-LH</p>
	<p>SUPPORTO PEDANA ALLUMINIO FOOTSTEP MOUNTING BRACKET ALUMINIUM</p> <p>COS.PEL. ref. SIMILAR ref. 1001.25104 5010640332</p> <p style="text-align: right;">DX RH</p> <p>1001.25105 5010640331</p> <p style="text-align: right;">SX LH</p>
	<p>GRIGLIA PEDANA SUPERIORE / INFERIORE P.P.G.F. - NERA UPPER / LOWER FOOTSTEP GRILLE P.P.G.F. - BLACK</p> <p>COS.PEL. ref. SIMILAR ref. 1001.53102 5010544030</p> <p style="text-align: right;">DX RH</p> <p>1001.53103 5010544029</p> <p style="text-align: right;">SX LH</p>
	<p>VASCHETTA ESPANSIONE EXPANSION TANK</p> <p>COS.PEL. ref. SIMILAR ref. 2101.30080 7485132205</p>
	<p>MOLLA A GAS Lunghezza [mm] 635 Corsa [mm] 270 Forza scarto [N] 200 GAS SPRING Lenght [mm] 635 Stroke [mm] 270 Waste force [N] 200</p> <p>COS.PEL. ref. SIMILAR ref. 2401.25100 5010353703</p>
	<p>MOLLA A GAS Lunghezza [mm] 615 Corsa [mm] 258 Forza scarto [N] 230 GAS SPRING Lenght [mm] 615 Stroke [mm] 258 Waste force [N] 230</p> <p>COS.PEL. ref. SIMILAR ref. 2401.25101 5010468003</p>
	<p>MOLLA A GAS Lunghezza [mm] 510 Corsa [mm] 167 Forza scarto [N] 260 GAS SPRING Lenght [mm] 510 Stroke [mm] 167 Waste force [N] 260</p> <p>COS.PEL. ref. SIMILAR ref. 2401.30101 5010623483 / 7484838520</p>



GRIGLIA PROTEZIONE FARO
Per Cos.Ma Tga / Cos.Re Premium-Kerax / Cos.Da Cf
HEADLAMP PROTECTION CAGE
For Cos.Ma Tga / Cos.Re Premium-Kerax / Cos.Da Cf

COS.PEL. ref. SIMILAR ref.
2000.00016 -

Nuovo Premium



	<p>GRIGLIA S.M.C. GRILLE S.M.C.</p> <p>COS.PEL. ref. SIMILAR ref. 101.30100 5010578248 / 7420843793</p>
<p>AD ESAURIMENTO SCORTE UNTIL STOCK-OUT</p> 	<p>GRIGLIA FRONTALE P.P. FRONT GRILLE P.P.</p> <p>COS.PEL. ref. SIMILAR ref. 101.30101 5010578246 / 5010578534</p>
	<p>RIPAROFANGO P.P. - NERO COVER REAR MUDGUARD P.P. - BLACK</p> <p>COS.PEL. ref. SIMILAR ref. 201.92548 5010578754</p> <p style="text-align: right;">DX-SX RH-LH</p>
	<p>RIPAROFANGO MUDGUARD</p> <p>COS.PEL. ref. SIMILAR ref. 202.14202 7421094406</p> <p style="text-align: right;">DX-SX RH-LH</p>
	<p>COPERCHIO PARAFANGO POSTERIORE A.B.S. - NERO COVER REAR MUDGUARD A.B.S. - BLACK</p> <p>COS.PEL. ref. SIMILAR ref. 202.92547 7420721840</p>

	<p>MEZZO PARAFANGO POSTERIORE (PARTE POSTERIORE) CON STAFFE REAR MUDGUARD (REAR PART) WITH BRACKETS</p> <p>COS.PEL. ref. SIMILAR ref. 201.28255 5001856195</p> <p style="text-align: right;">DX-SX RH-LH</p>
	<p>MEZZO PARAFANGO POSTERIORE (PARTE ANTERIORE) CON STAFFE REAR MUDGUARD (FRONT PART) WITH BRACKETS</p> <p>COS.PEL. ref. SIMILAR ref. 201.28256 5010314953</p> <p style="text-align: right;">DX-SX RH-LH</p>
	<p>PROLUNGA PARAFANGO MUDGUARD EXTENSION</p> <p>COS.PEL. ref. SIMILAR ref. 201.30544 5001867497</p> <p style="text-align: right;">DX RH</p> <p>201.30543 5010445634</p> <p style="text-align: right;">SX LH</p>
	<p>CALOTTA PARAFANGO CON 4 TIRANTI P.P. - NERO REAR MUDGUARD WITH 4 MUDGUARD TENSIONERS P.P. - BLACK</p> <p>COS.PEL. ref. SIMILAR ref. 201.30546 7421094390 / 7421094457</p> <p style="text-align: right;">DX-SX RH-LH</p> <p style="text-align: center;">(201.30548 versione senza i tiranti)</p>
	<p>CALOTTA PARAFANGO P.P. - NERO - 2010 REAR MUDGUARD P.P. - BLACK - TYPE 2010</p> <p>COS.PEL. ref. SIMILAR ref. 201.30548 7421094390</p> <p style="text-align: right;">DX-SX RH-LH</p> <p style="text-align: center;">Tirante : 1002.13005 - (201.30546 versione con i tiranti)</p>
	<p>MEZZO PARAFANGO POSTERIORE P.P. - NERO - PARTE ANTERIORE - 2010 REAR MUDGUARD P.P. - BLACK - FRONT PART - TYPE 2010</p> <p>COS.PEL. ref. SIMILAR ref. 201.30550 7421094392</p> <p style="text-align: right;">DX RH</p> <p>201.30549 7421094393</p> <p style="text-align: right;">SX LH</p>
	<p>RIPAROFANGO P.P. - GRIGIO MUDGUARD P.P. - GREY</p> <p>COS.PEL. ref. SIMILAR ref. 201.30552 5010578407</p> <p style="text-align: right;">DX RH</p> <p>201.30551 5010578401</p> <p style="text-align: right;">SX LH</p>
	<p>MEZZO PARAFANGO POSTERIORE (PARTE ANTERIORE) P.P. - NERO - 2010 REAR MUDGUARD (FRONT PART) P.P. - BLACK - TYPE 2010</p> <p>COS.PEL. ref. SIMILAR ref. 201.92546 7420583447</p> <p style="text-align: right;">DX RH</p> <p>201.92545 7420583442</p> <p style="text-align: right;">SX LH</p>







Nuovo Premium

	<p>CALOTTA PARAFANGO POSTERIORE CON 4 TIRANTI P.P. - NERO REAR MUDGUARD WITH 4 MUDGUARD TENSIONERS P.P. - BLACK</p> <p>COS.PEL. ref. SIMILAR ref. 202.13199 7421094387 / 7421094457 DX-SX RH-LH</p> <p>(202.13200 versione senza i tiranti)</p>
	<p>CALOTTA PARAFANGO POSTERIORE P.P. - NERO REAR MUDGUARD P.P. - BLACK</p> <p>COS.PEL. ref. SIMILAR ref. 202.13200 7421094387 DX-SX RH-LH</p> <p>Relativo tirante 1002.13005 - (202.13199 versione con i tiranti)</p>
	<p>MEZZO PARAFANGO POSTERIORE (PARTE POSTERIORE) P.P. - NERO REAR MUDGUARD (REAR PART) P.P. - BLACK</p> <p>COS.PEL. ref. SIMILAR ref. 202.13201 7421094394 DX-SX RH-LH</p>
	<p>CALOTTA PARAFANGO POSTERIORE CON 4 TIRANTI P.P. - GRIGIO REAR MUDGUARD WITH 4 MUDGUARD TENSIONERS P.P. - GREY</p> <p>COS.PEL. ref. SIMILAR ref. 202.71388 7420498623 / 7420936772 DX-SX RH-LH</p> <p>(202.71391 versione senza i tiranti)</p>
	<p>CALOTTA PARAFANGO POSTERIORE CON 4 TIRANTI P.P. - GRIGIO - RIBASSATA REAR MUDGUARD FLAT TYPE W. 4 MUDG.TENSION. P.P. - GREY</p> <p>COS.PEL. ref. SIMILAR ref. 202.71389 7420726748 / 7420936768 DX-SX RH-LH</p> <p>(202.71390 versione senza i tiranti)</p>
	<p>CALOTTA PARAFANGO POSTERIORE P.P. - GRIGIO - RIBASSATA REAR MUDGUARD P.P. - GREY</p> <p>COS.PEL. ref. SIMILAR ref. 202.71390 7420726748 / 7420936768 DX-SX RH-LH</p> <p>Relativo tirante 1002.56557 - (202.71389 versione con i tiranti)</p>
	<p>CALOTTA PARAFANGO POSTERIORE P.P. - GRIGIO REAR MUDGUARD P.P. - GREY</p> <p>COS.PEL. ref. SIMILAR ref. 202.71391 7420936772 DX-SX RH-LH</p> <p>Relativi tiranti 1002.56557/8 (7 per COS.VO e 8 per COS.RE)</p>
	<p>MEZZO PARAFANGO POSTERIORE P.P. - GRIGIO REAR MUDGUARD P.P. - GREY</p> <p>COS.PEL. ref. SIMILAR ref. 202.92544 7420583488 / 7420771757 DX-SX RH-LH</p> <p>Legato a 1002.56559 2pz + 1002.56564 2pz</p>

	<p>RIPARO PEDANA H.D.P.E. - NERO FOOTSTEP PROTECTION H.D.P.E. - BLACK COS.PEL. ref. SIMILAR ref. 301.30006 5010225405 / 5010578396 DX RH</p> <p>301.30005 5010225404 / 5010578395 SX LH</p>
	<p>PEDANA PARAFANGO P.P.G.F. - PRIMER MUDGUARD FOOTSTEP P.P.G.F. - PRIMER COS.PEL. ref. SIMILAR ref. 301.30008 5010353004 / 5010468636 DX RH</p> <p>301.30007 Griglia/Grille 1001.53102 5010353003 / 5010468635 SX LH Griglia/Grille 1001.53103</p>
	<p>PEDANA P.P.G.F. - GRIGIO SCURO - 10-05> FOOTSTEP P.P.G.F. - DARK GREY - 10-05> COS.PEL. ref. SIMILAR ref. 301.30004 5010578876 DX RH</p> <p>301.30003 Griglia/Grille: 1001.53100 inf - 1001.53102 sup 5010578376 SX LH Griglia/Grille: 1001.53101 inf - 1001.53103 sup</p>
	<p>PEDANA P.P. - PRIMER FOOTSTEP P.P. - PRIMER COS.PEL. ref. SIMILAR ref. 301.30010 5010578878 DX RH</p> <p>301.30009 Griglia/Grille : 1001.53100 inf - 1001.53102 sup 5010578378 SX LH Griglia/Grille : 1001.53101 inf - 1001.53103 sup</p>
	<p>PEDANA P.P. - BIANCO SMALTATO FOOTSTEP P.P. - WHITE ENAMELLED COS.PEL. ref. SIMILAR ref. 301.30012 - DX RH</p> <p>301.30011 Griglia/Grille : 1001.53100 inf - 1001.53102 sup - SX LH Griglia/Grille: 1001.53101 inf - 1001.53103 sup</p>
	<p>PARAURTI ANTERIORE CON COMPONENTI P.P.G.F. - GRIGIO - 10-05> FRONT BUMPER WITH KIT P.P.G.F. - GREY - 10-05> COS.PEL. ref. SIMILAR ref. 401.30615 5010623600 / 7420928994</p> <p>401.30590 + 401.30589 (x 2) + 401.30596/7/8/9</p>
	<p>PARAURTI ANTERIORE P.P.G.F. - GRIGIO SCURO - 10-05> FRONT BUMPER P.P.G.F. - DARK GREY - 10-05> COS.PEL. ref. SIMILAR ref. 401.30590 5010623600 / 7420928994 / 7482677299</p>
	<p>TAPPO PARAURTI P.P. - GRIGIO SCURO COVER BUMPER P.P. - DARK GREY COS.PEL. ref. SIMILAR ref. 401.30589 7420973757 / 7420973762 DX-SX RH-LH</p>

Nuovo Premium

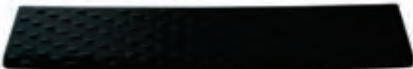
	<p>ANGOLO PARAURTI P.P.G.F. - GRIGIO SCURO - 10-05> CORNER BUMPER P.P.G.F. - DARK GREY - 10-05> COS.PEL. ref. SIMILAR ref. 401.30592 5010578336 DX RH</p> <p>401.30591 5010578335 SX LH</p>
	<p>PARAURTI ANTERIORE PRIMER CON COMPONENTI P.P.G.F. - PRIMER - 10-05> FRONT BUMPER WITH KIT P.P.G.F. - PRIMER - 10-05> COS.PEL. ref. SIMILAR ref. 401.30612 5010623600 / 7420928994</p> <p>401.30600 + 401.30595 (x 2) + 401.30596/7/8/9</p>
	<p>PARAURTI ANTERIORE P.P.G.F. - PRIMER - 10-05> FRONT BUMPER P.P.G.F. - PRIMER - 10-05> COS.PEL. ref. SIMILAR ref. 401.30600 5010623600 / 7420928994 / 7482677299</p>
	<p>TAPPO PARAURTI P.P. - PRIMER COVER BUMPER P.P. - PRIMER COS.PEL. ref. SIMILAR ref. 401.30595 7420973757 / 7420973762 DX-SX RH-LH</p>
	<p>ANGOLO PARAURTI P.P.G.F. - PRIMER - 10-05> CORNER BUMPER P.P.G.F. - PRIMER - 10-05> COS.PEL. ref. SIMILAR ref. 401.30602 5010578336 DX RH</p> <p>401.30601 5010578335 SX LH</p>
	<p>PARAURTI ANTERIORE CON COMPONENTI P.P.G.F. - BIANCO - 10-05> FRONT BUMPER WITH KIT P.P.G.F. - WHITE - 10-05> COS.PEL. ref. SIMILAR ref. 401.30616 5010623600 / 7420928994</p> <p>401.30606 + 401.30593 (x 2) + 401.30596/7/8/9</p>
	<p>PARAURTI ANTERIORE P.P.G.F. - BIANCO SMALTATO FRONT BUMPER P.P.G.F. - WHITE ENAMELLED COS.PEL. ref. SIMILAR ref. 401.30606 5010623600 / 7420928994 / 7482677299</p>
	<p>TAPPO PARAURTI P.P. - BIANCO SMALTATO BUMPER COVER P.P. - WHITE ENAMELLED COS.PEL. ref. SIMILAR ref. 401.30593 7420973757 / 7420973762 DX-SX RH-LH</p>

	<p>ANGOLO PARAURTI P.P.G.F. - BIANCO SMALTATO CORNER BUMPER P.P.G.F. - WHITE ENAMELLED COS.PEL. ref. SIMILAR ref. 401.30608 5010578336 DX RH</p> <p>401.30607 5010578335 SX LH</p>
	<p>ANGOLO SOTTOPARAURTI P.P. - GRIGIO - 10-05> CORNER SPOILER P.P. - GREY - 10-05> COS.PEL. ref. SIMILAR ref. 401.30604 5010578355 DX RH</p> <p>401.30603 5010578354 SX LH</p>
	<p>SOTTOPARAURTI CENTRALE P.P. - GRIGIO - 10-05> CENTRAL SPOILER P.P. - GREY - 10-05> COS.PEL. ref. SIMILAR ref. 401.30605 5010578352</p>
	<p>GRIGLIA PARAURTI SUPERIORE P.P. - GRIGIO UPPER BUMPER GRILLE P.P. - GREY COS.PEL. ref. SIMILAR ref. 401.30596 5010578350</p>
	<p>GRIGLIA PARAURTI INFERIORE P.P. - GRIGIO LOWER BUMPER GRILLE P.P. - GREY COS.PEL. ref. SIMILAR ref. 401.30597 5010578348</p>
	<p>PEDANA PARAURTI SUPERIORE P.P. - NERO UPPER FRONT BUMPER STEP P.P. - BLACK COS.PEL. ref. SIMILAR ref. 401.30598 5010578346 / 7420973875</p>
	<p>PEDANA PARAURTI INFERIORE P.P. - NERO LOWER FRONT BUMPER STEP P.P. - BLACK COS.PEL. ref. SIMILAR ref. 401.30599 5010578344 / 7420973877</p>
	<p>ANGOLO PARAURTI METALLO - GRIGIO BUMPER CORNER METAL - GREY COS.PEL. ref. SIMILAR ref. 401.30614 5010578813 DX RH</p> <p>401.30613 5010578812 SX LH</p>

Nuovo Premium

	<p>SPECCHIO RETROVISORE ARGENTO - RISCALDATO - G.A. REAR-VIEW MIRROR SILVER - HEATED - WIDE ANGLE COS.PEL. ref. SIMILAR ref. 501.30394 7420903746 / 7420903887 / 7420904269 DX RH</p> <p>501.30395 7420903745 / 7420903885 / 7420904268 SX LH</p>
	<p>SPECCHIO RETROVISORE NERO - RISCALDATO - G.A. REAR-VIEW MIRROR BLACK - HEATED - WIDE ANGLE COS.PEL. ref. SIMILAR ref. 501.30396 7420903746 / 7420903883 / 7420904269 DX RH</p> <p>501.30397 7420903745 / 7420903882 / 7420904268 SX LH</p>
	<p>SPECCHIO RETROVISORE GRIGIO - ELETTRICO - RISCALDATO REAR-VIEW MIRROR GREY - ELECTRIC - HEATED COS.PEL. ref. SIMILAR ref. 501.30398 7420866665 / 7420903881 / 7485120820 DX-SX RH-LH</p>
	<p>SPECCHIO RETROVISORE NERO - ELETTRICO - RISCALDATO REAR-VIEW MIRROR BLACK - ELECTRIC - HEATED COS.PEL. ref. SIMILAR ref. 501.30399 7420862795 / 7420866665 / 7420903880 / 7485120820 DX-SX RH-LH</p>
	<p>VETRO SPECCHIO INFERIORE RISCALDATO LOWER MIRROR GLASS HEATED COS.PEL. ref. SIMILAR ref. 501.30400 7420862795 DX-SX RH-LH</p>
	<p>VETRO SPECCHIO SUPERIORE G.A. - RISCALDATO - RAGGIO 300 UPPER MIRROR GLASS WIDE ANGLE - HEATED - RADIUS 300 COS.PEL. ref. SIMILAR ref. 501.30402 7420903746 DX RH</p> <p>501.30401 7420903745 SX LH</p>
	<p>COPERCHIO RETROVISORE SUPERIORE NERO - G.A. UPPER REAR-VIEW MIRROR COVER BLACK - WIDE ANGLE COS.PEL. ref. SIMILAR ref. 501.30404 7420903883 DX RH</p> <p>501.30403 7420903882 SX LH</p>
	<p>COPERCHIO RETROVISORE SUPERIORE NERO UPPER REAR-VIEW MIRROR COVER BLACK COS.PEL. ref. SIMILAR ref. 501.30405 7420862779 / 7420903880 DX-SX RH-LH</p>







	<p>COPPA CON MOTORINO HOUSING WITH MOTOR</p> <p>COS.PEL. ref. SIMILAR ref. 501.30406 7420866665 / 7485120820 DX-SX RH-LH</p>
	<p>COPPA G.A. HOUSING WIDE ANGLE</p> <p>COS.PEL. ref. SIMILAR ref. 501.30408 7420904269 DX RH</p> <p>501.30407 7420904268 SX LH</p>
	<p>SPECCHIO RETROVISORE NERO - ELETTRICO - RISCALDATO - CORTO 100 REAR-VIEW MIRROR BLACK - ELECTRIC - HEATED - SHORT 100</p> <p>COS.PEL. ref. SIMILAR ref. 501.30410 5010578504 / 7421326550 DX RH</p> <p>501.30409 5010578503 SX LH</p>
	<p>COPRIBRACCIO INFERIORE P.P. - NERO BRACKET LOWER PROTECTION P.P. - BLACK</p> <p>COS.PEL. ref. SIMILAR ref. 501.30412 5010623058 DX RH</p> <p>501.30411 5010623057 SX LH</p>
	<p>SPECCHIO RETROVISORE ELETTRICO - RISCALDATO - ARGENTO - CORTO 100 REAR-VIEW MIRROR ELETTRIC - HEATED - SILVER - SHORT 100</p> <p>COS.PEL. ref. SIMILAR ref. 501.30414 5010578506 / 7421326551 DX RH</p> <p>501.30413 5010578505 SX LH</p>
	<p>COPERCHIO RETROVISORE G.A. ARGENTO REAR-VIEW COVER SILVER</p> <p>COS.PEL. ref. SIMILAR ref. 501.30416 7420903887 DX RH</p> <p>501.30415 7420903885 SX LH</p>
	<p>COPERCHIO RETROVISORE ARGENTO REAR-VIEW COVER SILVER</p> <p>COS.PEL. ref. SIMILAR ref. 501.30417 7420903881 DX-SX RH-LH</p>
	<p>SPECCHIO GUARDARUOTA ROOF MIRROR</p> <p>COS.PEL. ref. SIMILAR ref. 501.30418 5010578511 DX RH</p>









Nuovo Premium

	<p>SPECCHIO RETROVISORE FRONTALE FRONT REAR-VIEW MIRROR</p> <p>COS.PEL. ref. 501.30420 SIMILAR ref. 7420849837 / 7482226025 DX-SX RH-LH</p>
	<p>COPERCHIO GRANDANGOLO GRIGIO (PREMIUM DISTRIBUZIONE) COVER WIDE ANGLE GREY (PREMIUM DISTRIBUTION)</p> <p>COS.PEL. ref. 501.31499 SIMILAR ref. 7420903736 DX-SX RH-LH</p>
	<p>COPERCHIO GRANDANGOLO NERO (PREMIUM DISTRIBUZIONE) COVER WIDE ANGLE BLACK (PREMIUM DISTRIBUTION)</p> <p>COS.PEL. ref. 501.31500 SIMILAR ref. 7420862800 DX-SX RH-LH</p>
	<p>COPPA G.A. PREMIUM DISTRIBUZIONE HOUSING WIDE ANGLE PREMIUM DISTRIBUTION</p> <p>COS.PEL. ref. 501.31502 SIMILAR ref. 7420862813 DX RH</p> <p>501.31501 7420862809 SX LH</p>
	<p>VETRO SPECCHIO G.A. DISTRIBUZIONE RISCALDATO GLASS WIDE ANGLE DISTRIBUTION HEATED</p> <p>COS.PEL. ref. 501.31504 SIMILAR ref. 7420862815 DX RH</p> <p>501.31503 7420862810 SX LH</p>
	<p>SPECCHIO RETROVISORE ELETTRICO - RISCALDATO - NERO - BRACCIO CORTO 100 REAR-VIEW MIRROR ELECTRIC - HEATED - BLACK - SHORT ARM 100</p> <p>COS.PEL. ref. 501.31506 SIMILAR ref. 5010623232 / 7421326527 DX RH</p> <p>501.31505 5010623231 SX LH</p>
	<p>SPECCHIO RETROVISORE ELETTRICO - RISCALDATO - NERO - BRACCIO LUNGO 200 REAR-VIEW MIRROR ELECTRIC - HEATED - BLACK - LONG ARM 200</p> <p>COS.PEL. ref. 501.31508 SIMILAR ref. 5010623247 / 7421326526 DX RH</p> <p>501.31507 5010623246 SX LH</p>
	<p>BRACCIO SPECCHIO LUNGO BRACCIO LUNGO 200 - FORNITO DI CAVI MIRROR BRACKET LONG LONG ARM 200 - WITH CABLES</p> <p>COS.PEL. ref. 501.31510 SIMILAR ref. 7420903732 DX RH</p> <p>501.31509 7420903723 SX LH</p>

	<p>BRACCIO SPECCHIO CORTO BRACCIO CORTO 100 MIRROR BRACKET SHORT SHORT ARM 100 COS.PEL. ref. SIMILAR ref. 501.31512 7420903727 DX RH</p> <p>501.31511 7420903722 SX LH</p>
	<p>VISIERA NUOVO PREMIUM TETTO ALTO SUN VISOR NEW PREMIUM HIGH CAB COS.PEL. ref. SIMILAR ref. 701.30100 5010578255 Relativo kit staffe 1001.30100 (oe 5010578257)</p>
	<p>CONVOGLIATORE ARIA A.B.S. - BIANCO AIR CONVEYOR A.B.S. - WHITE COS.PEL. ref. SIMILAR ref. 901.30160 5010578238 / 5010578244 DX RH</p> <p>901.30161 5010578237 / 5010578243 SX LH</p>
	<p>STAFFA PEDANA METALLO - NERO FOOTSTEP BRACKET METAL - BLACK COS.PEL. ref. SIMILAR ref. 1001.00011 7482962977</p>
	<p>SUPPORTO PEDANA ALLUMINIO FOOTSTEP MOUNTING BRACKET ALUMINIUM COS.PEL. ref. SIMILAR ref. 1001.00016 5010610723 / 7421087113 DX-SX RH-LH</p>
	<p>SUPPORTO PARAURTI FRONT BUMPER BRACKET COS.PEL. ref. SIMILAR ref. 1001.30000 5010304723 / 7420819613 / 7482317469 DX RH</p> <p>1001.30001 5010304722 / 7420819616 / 7482317468 SX LH</p>
	<p>SUPPORTO PARAFANGO ANTERIORE FRONT MUDGUARD BRACKET COS.PEL. ref. SIMILAR ref. 1001.30006 7420493931 DX RH</p> <p>1001.30005 7420493933 SX LH</p>
	<p>TUBO FISSAGGIO PARAFANGO POST. PARTE POST. CON GOMMINO - CM 65,5 SUPPORT BRACKET REAR PART WITH RUBBER - CM 65,5 COS.PEL. ref. SIMILAR ref. 1001.30101 7421094415</p>

Nuovo Premium

	<p>TUBO FISSAGGIO PARAFANGO POST. PARTE ANT. CON GOMMINO - CM 56 REAR SUPPORT BRACKET FRONT PART WITH RUBBER - CM 56</p> <p>COS.PEL. ref. SIMILAR ref. 1001.30102 7421094410</p>
	<p>STAFFA PARAFANGO POSTERIORE LUNGA METALLO - NERO REAR MUDGUARD BRACKET METAL - BLACK</p> <p>COS.PEL. ref. SIMILAR ref. 1001.30103 7421094456</p>
	<p>STAFFA PARAFANGO POSTERIORE METALLO - NERO REAR MUDGUARD BRACKET METAL - BLACK</p> <p>COS.PEL. ref. SIMILAR ref. 1001.30104 7421094454</p>
	<p>SUPPORTO PARAFANGO POSTERIORE PICCOLO ALLUMINIO REAR MUDGUARD BRACKET ALUMINIUM</p> <p>COS.PEL. ref. SIMILAR ref. 1002.13006 7421090272</p>
	<p>SUPPORTO PARAFANGO POSTERIORE GRANDE ALLUMINIO REAR MUDGUARD BRACKET ALUMINIUM</p> <p>COS.PEL. ref. SIMILAR ref. 1002.13007 7421213203</p>
	<p>COPRI BATTERIE P.P.G.F. - NERO BATTERY COVER P.P.G.F. - BLACK</p> <p>COS.PEL. ref. SIMILAR ref. 1002.13010 7420842848</p>
	<p>COLLARE DI FISSAGGIO PARAFANGO METALLO BRACKET MUDGUARD METAL</p> <p>COS.PEL. ref. SIMILAR ref. 1006.33602 5001833310</p>
 	<p>FANALINO LATERALE CORNER LAMP</p> <p>COS.PEL. ref. SIMILAR ref. 1601.50025 5001834561</p> <p style="text-align: right;">DX-SX RH-LH</p>

	<p>PROIETTORE SENZA MOTORINO H1 H7 PY21W W5W FENDINEBBIA H3 - PREDISPOSTO PER CORRETTORE ASSETTO HEADLAMP WITHOUT MOTOR H1 H7 PY21W W5W FOG LAMP H3 - SUITABLE FOR LOAD LEVEL ADJUSTMENT COS.PEL. ref. SIMILAR ref. 1601.30800 5010578476 / 7421636310 / 7482588693 DX RH</p> <p>1601.30801 5010578452 / 7421636296 / 7482588679 SX LH</p>
	<p>PROIETTORE H1 H3 H7 PY21W W5W - CORRETTORE ASSETTO MANUALE - PARABOLA NERA HEADLAMP H1 H3 H7 PY21W W5W - MANUAL LOAD LEVEL ADJUSTEMENT - BLACK COS.PEL. ref. SIMILAR ref. 1601.30802 5010578478 / 7421636312 DX RH</p> <p>1601.30803 5010578454 / 7482588681 SX LH</p>
	<p>PROIETTORE H1 H3 H7 PY21W W5W - CORRETTORE ASSETTO MANUALE - PARABOLA CHIARA HEADLAMP H1 H3 H7 PY21W W5W - MANUAL LOAD LEVEL ADJUSTEMENT - LIGHT COLOURED COS.PEL. ref. SIMILAR ref. 1601.30804 5010578475 / 7421636309 / 7482588692 DX RH</p> <p>1601.30805 5010578451 / 7421636295 / 7482588678 SX LH</p>
	<p>CERNIERA FRONT PANEL HINGE COS.PEL. ref. SIMILAR ref. 1701.30600 5010225459 / 5010468879 DX-SX RH-LH</p>
	<p>FERMAPORTA DOOR STOP COS.PEL. ref. SIMILAR ref. 1701.53608 5010225930 DX-SX RH-LH</p>
	<p>FERMAPORTA DOOR STOP BRACKET COS.PEL. ref. SIMILAR ref. 1701.53609 5010225908 DX-SX RH-LH</p>
	<p>SERRATURA PORTA DOOR LOCK COS.PEL. ref. SIMILAR ref. 1701.53610 20864258 / 7420864258 DX RH</p> <p>1701.53611 20864256 / 7420864256 SX LH</p>
	<p>DISPOSITIVO DI CHIUSURA PER GRIGLIA ANTERIORE FRONT PANEL CATCH COS.PEL. ref. SIMILAR ref. 1701.53612 5010353170 / 7482690386</p>

Nuovo Premium

	<p>SUPPORTO FARO HEAD LAMP LOCK</p> <p>COS.PEL. ref. 1701.53613 SIMILAR ref. 5010225716</p> <p style="text-align: right;">DX-SX RH-LH</p>
	<p>SERRATURA PORTA DOOR LOCK</p> <p>COS.PEL. ref. 1701.53614 SIMILAR ref. 5001858127</p> <p style="text-align: right;">DX RH</p> <p>1701.53615 5001858126</p> <p style="text-align: right;">SX LH</p>
	<p>CERNIERA A.B.S. - NERO HINGE A.B.S. - BLACK</p> <p>COS.PEL. ref. 1701.53616 SIMILAR ref. 5010468880</p> <p style="text-align: right;">DX-SX RH-LH</p>
	<p>ALZACRISTALLI SENZA MOTORINO WINDOW REGULATOR WITHOUT MOTOR - MANUAL</p> <p>COS.PEL. ref. 1901.30700 SIMILAR ref. -</p> <p style="text-align: right;">DX RH</p> <p>1901.30701 -</p> <p style="text-align: right;">SX LH</p>
	<p>ALZACRISTALLI ELETTRICO - CON MOTORINO - 2 PIN WINDOW REGULATOR ELECTRIC - WITH MOTOR - 2 PIN</p> <p>COS.PEL. ref. 1901.30702 SIMILAR ref. 5010301994 / 7422189861 / 7482497194</p> <p style="text-align: right;">DX RH</p> <p>1901.30703 5010301993 / 7422189860 / 7482497193</p> <p style="text-align: right;">SX LH</p>
	<p>VASCHETTA ESPANSIONE EXPANSION TANK</p> <p>COS.PEL. ref. 2101.30080 SIMILAR ref. 7485132205</p>
	<p>TIRANTE CALOTTA GOMMA - NERO MUDGUARD TENSIONER RUBBER - BLACK</p> <p>COS.PEL. ref. 1002.13005 SIMILAR ref. 7421094457</p>
	<p>TIRANTE PARAFANGO GOMMA - NERO MUDGUARD TENSIONER RUBBER - BLACK</p> <p>COS.PEL. ref. 1002.56558 SIMILAR ref. 7420498623</p>

	<p>MOLLA A GAS Lunghezza [mm] 630 Corsa [mm] 250 Forza scarto [N] 400 GAS SPRING Lenght [mm] 630 Stroke [mm] 250 Waste force [N] 400</p> <p>COS.PEL. ref. SIMILAR ref. 2401.30100 5010578586</p>
	<p>MOLLA A GAS Lunghezza [mm] 510 Corsa [mm] 167 Forza scarto [N] 260 GAS SPRING Lenght [mm] 510 Stroke [mm] 167 Waste force [N] 260</p> <p>COS.PEL. ref. SIMILAR ref. 2401.30101 5010623483 / 7484838520</p>
	<p>DEFLETTORI LATERALI CON CLIPS SIDEWINDOW DEFLECTORS WITH CLIPS</p> <p>COS.PEL. ref. SIMILAR ref. 3002.00002 -</p>
	<p>KIT PER CONNESSIONI ELETTRICHE Connettore AMP 1,5 singolo KIT FOR ELECTRICAL JOINTS Connector AMP 1,5 simple</p> <p>COS.PEL. ref. SIMILAR ref. 003120 -</p>
	<p>KIT PER CONNESSIONI ELETTRICHE Connettore SUPERSEAL 2 vie femmina KIT FOR ELECTRICAL JOINTS Connector SUPERSEAL ways female</p> <p>COS.PEL. ref. SIMILAR ref. 003123 -</p> <p>Connettore per la serie 1500.xxxxx</p>
	<p>FANALE POSTERIORE REAR-LIGHT</p> <p>LED - 24V - CONNETTORE POSTERIORE AMP 1.5 LED - 24V - REAR CONNECTOR AMP 1.5</p> <p>COS.PEL. ref. SIMILAR ref. 1500.00000 -</p> <p>1500.00001 -</p> <p>TRASPARENTE / LENS</p> <p>Relativo connettore multipolare 003120 DX RH Relativo connettore multipolare 003120 SX LH</p>
	<p>FANALE POSTERIORE REAR-LIGHT</p> <p>7 FUNZIONI - CONNETTORE LATERALE AMP 1.5 7 FUNCTIONS - LATERAL CONNECTOR AMP 1.5</p> <p>COS.PEL. ref. SIMILAR ref. 1501.30000 7420802350</p> <p>1501.30001 7420802348</p> <p>TRASPARENTE / LENS</p> <p>1501.30100 7420802418 (ex 010082) DX-SX RH-LH</p> <p>Relativo connettore 003120 Con luce targa / With plate light (ex 006015) - Conn. 003120</p>
	<p>FANALE POSTERIORE REAR-LIGHT</p> <p>7 FUNZIONI - CONNETTORE LATERALE AMP 1.5 7 FUNCTIONS - LATERAL CONNECTOR AMP 1.5</p> <p>COS.PEL. ref. SIMILAR ref. 1501.30002 7420802353</p> <p>TRASPARENTE / LENS</p> <p>1501.30100 7420802418 (ex 010082) DX-SX RH-LH</p> <p>Con cicalino / With buzzer (ex 006016) - Connettore 003120</p>



	<p>GRIGLIA PARAURTI P.P. - NERO BUMPER GRILLE P.P. - BLACK</p> <p>COS.PEL. ref. SIMILAR ref. 101.23101 5010468582</p>
	<p>RIPAROFANGO MUDGUARD</p> <p>COS.PEL. ref. SIMILAR ref. 202.14202 7421094406 DX-SX RH-LH</p>
	<p>CALOTTA PARAF. POSTER. R 3a SERIE CON 4 TIRANTI P.P. - NERO - 12-04 REAR MUDGUARD 3RD SERIES WITH 4 M. TENSIONERS P.P. - BLACK - 12-04</p> <p>COS.PEL. ref. SIMILAR ref. 201.14950 5001856184 / 5010314951 DX-SX RH-LH (201.14951 versione senza i tiranti)</p>
	<p>CALOTTA PARAFANGO POSTERIORE P.P. - NERO - 12-04 - 3a serie REAR MUDGUARD P.P. - BLACK - 12-04 - 3rd series</p> <p>COS.PEL. ref. SIMILAR ref. 201.14951 5010314951 DX-SX RH-LH Tirante : 1001.14951 - (201.14950 versione con i tiranti)</p>
	<p>CALOTTA PARAFANGO POSTERIORE P.P. - NERO - 01-00 > 12-03 - 4a serie REAR MUDGUARD P.P. - BLACK - 01-00 > 12-03 - 4th series</p> <p>COS.PEL. ref. SIMILAR ref. 201.14952 5010314952 DX-SX RH-LH Tirante : 1001.14951 - (201.14953 versione con i tiranti)</p>

	<p>CALOTTA PARAF. POST. R 4a S. CORTA CON 4 TIRANTI P.P. - NERO - 01-00 > 12-03 REAR MUDGUARD 4RD SERIES WITH 4 M. TENSIONERS P.P. - BLACK - 01-00 > 12-03</p> <p>COS.PEL. ref. SIMILAR ref. 201.14953 5001856184 / 5010314952 DX-SX RH-LH</p> <p>(201.14952 versione senza i tiranti)</p>
	<p>CALOTTA PARAFANGO POSTERIORE P.P. - NERO - 12-00 - 2a serie REAR MUDGUARD P.P. - BLACK - 12-00 - 2nd series</p> <p>COS.PEL. ref. SIMILAR ref. 201.28253 5010228253 DX-SX RH-LH</p> <p>Tirante : 1001.00001 - (201.28254 versione con i tiranti)</p>
	<p>CALOTTA PARAF. POSTER. 2a SERIE CON 4 TIRANTI P.P. - NERO - 12-00 REAR MUDGUARD 2ND SERIES WITH 4 M. TENSIONERS P.P. - BLACK - 12-00</p> <p>COS.PEL. ref. SIMILAR ref. 201.28254 5001842757 / 5010228253 DX-SX RH-LH</p> <p>(201.28253 versione senza i tiranti)</p>
	<p>CALOTTA PARAF. RIBASSATA CON 4 TIRANTI P.P. - NERO - 2010 REAR MUDGUARD FLAT WITH 4 M. TENSIONERS P.P. - BLACK - 2010</p> <p>COS.PEL. ref. SIMILAR ref. 201.30545 7421094389 / 7421094457 DX-SX RH-LH</p> <p>(201.30547 versione senza i tiranti)</p>
	<p>CALOTTA PARAFANGO CON 4 TIRANTI P.P. - NERO REAR MUDGUARD WITH 4 MUDGUARD TENSIONERS P.P. - BLACK</p> <p>COS.PEL. ref. SIMILAR ref. 201.30546 7421094390 / 7421094457 DX-SX RH-LH</p> <p>(201.30548 versione senza i tiranti)</p>
	<p>CALOTTA PARAFANGO RIBASSATA P.P. - NERO - 2010 REAR MUDGUARD FLAT P.P. - BLACK - TYPE 2010</p> <p>COS.PEL. ref. SIMILAR ref. 201.30547 7421094389 DX-SX RH-LH</p> <p>Tirante : 1002.13005 - (201.30545 versione con i tiranti)</p>
	<p>CALOTTA PARAFANGO P.P. - NERO - 2010 REAR MUDGUARD P.P. - BLACK - TYPE 2010</p> <p>COS.PEL. ref. SIMILAR ref. 201.30548 7421094390 DX-SX RH-LH</p> <p>Tirante : 1002.13005 - (201.30546 versione con i tiranti)</p>
	<p>MEZZO PARAFANGO POSTERIORE P.P. - NERO - PARTE ANTERIORE - 2010 REAR MUDGUARD P.P. - BLACK - FRONT PART - TYPE 2010</p> <p>COS.PEL. ref. SIMILAR ref. 201.30550 7421094392 DX RH</p> <p>201.30549 7421094393 SX LH</p>

AE - Magnum

	<p>CALOTTA PARAF. POSTER. R 1a SERIE CON 4 TIRANTI A.B.S. - NERO - 12-99 REAR MUDGUARD 1ST SERIES WITH 4 M. TENSIONERS A.B.S. - BLACK - 12-99</p> <p>COS.PEL. ref. SIMILAR ref. 201.32440 5001823641 / 5010132441 DX-SX RH-LH</p> <p>(201.32441 versione senza i tiranti)</p>
	<p>CALOTTA PARAFANGO POSTERIORE A.B.S. - NERO - 12-99 - 1a serie REAR MUDGUARD A.B.S. - BLACK - 12-99 - 1st series</p> <p>COS.PEL. ref. SIMILAR ref. 201.32441 5010132441 DX-SX RH-LH</p> <p>Tirante : 1001.23641 - (201.32440 versione con i tiranti)</p>
	<p>CALOTTA PARAFANGO POSTERIORE CON 4 TIRANTI P.P. - NERO REAR MUDGUARD WITH 4 MUDGUARD TENSIONERS P.P. - BLACK</p> <p>COS.PEL. ref. SIMILAR ref. 202.13199 7421094387 / 7421094457 DX-SX RH-LH</p> <p>(202.13200 versione senza i tiranti)</p>
	<p>CALOTTA PARAFANGO POSTERIORE P.P. - NERO REAR MUDGUARD P.P. - BLACK</p> <p>COS.PEL. ref. SIMILAR ref. 202.13200 7421094387 DX-SX RH-LH</p> <p>Relativo tirante 1002.13005 - (202.13199 versione con i tiranti)</p>
	<p>MEZZO PARAFANGO POSTERIORE (PARTE POSTERIORE) P.P. - NERO REAR MUDGUARD (REAR PART) P.P. - BLACK</p> <p>COS.PEL. ref. SIMILAR ref. 202.13201 7421094394 DX-SX RH-LH</p>
	<p>CALOTTA PARAFANGO POSTERIORE CON 4 TIRANTI P.P. - GRIGIO - RIBASSATA REAR MUDGUARD FLAT TYPE W. 4 MUDG.TENSION. P.P. - GREY</p> <p>COS.PEL. ref. SIMILAR ref. 202.71389 7420726748 / 7420936768 DX-SX RH-LH</p> <p>(202.71390 versione senza i tiranti)</p>
	<p>CALOTTA PARAFANGO POSTERIORE P.P. - GRIGIO - RIBASSATA REAR MUDGUARD P.P. - GREY</p> <p>COS.PEL. ref. SIMILAR ref. 202.71390 7420726748 / 7420936768 DX-SX RH-LH</p> <p>Relativo tirante 1002.56557 - (202.71389 versione con i tiranti)</p>
	<p>MEZZO PARAFANGO POSTERIORE P.P. - GRIGIO REAR MUDGUARD P.P. - GREY</p> <p>COS.PEL. ref. SIMILAR ref. 202.92544 7420583488 / 7420771757 DX-SX RH-LH</p> <p>Legato a 1002.56559 2pz + 1002.56564 2pz</p>

	<p>ANGOLO PARAURTI G.R.P. - PRIMER CORNER BUMPER G.R.P. - PRIMER</p> <p>COS.PEL. ref. SIMILAR ref. 401.19006 5010219008</p> <p style="text-align: right;">DX RH</p>
	<p>ANGOLO PARAURTI G.R.P. - PRIMER CORNER BUMPER G.R.P. - PRIMER</p> <p>COS.PEL. ref. SIMILAR ref. 401.19008 5000938737 / 5010491629</p> <p style="text-align: right;">DX RH</p> <p>401.19009 5010219006</p> <p style="text-align: right;">SX LH</p>
	<p>ANGOLO PARAURTI 2a serie G.R.P. - PRIMER CORNER BUMPER 2nd series G.R.P. - PRIMER</p> <p>COS.PEL. ref. SIMILAR ref. 401.19010 5010574309</p> <p style="text-align: right;">DX RH</p> <p>401.19011 5010574311</p> <p style="text-align: right;">SX LH</p>
	<p>PARAURTI 2a serie P.P.G.F - PRIMER BUMPER 2nd series P.P.G.F - PRIMER</p> <p>COS.PEL. ref. SIMILAR ref. 401.19012 5010468593 / 5010544561</p>
	<p>SPECCHIO RETROVISORE R/300 GRANDANGOLO - RISCALDATO REAR-VIEW MIRROR RADIUS/300 WIDE ANGLE - HEATED</p> <p>COS.PEL. ref. SIMILAR ref. 501.07913 5000296871 / 5001873673</p>
	<p>SPECCHIO RETROVISORE ELETTRICO - RISCALDATO REAR-VIEW MIRROR ELECTRIC - HEATED</p> <p>COS.PEL. ref. SIMILAR ref. 501.07922 5001842202</p> <p style="text-align: right;">DX RH</p> <p>501.07923 5001838475</p> <p style="text-align: right;">SX LH</p>
	<p>SPECCHIO FRONTALE MANUALE - RAGGIO 300 FRONT DOOR MIRROR MANUAL - RADIUS 300</p> <p>COS.PEL. ref. SIMILAR ref. 501.07924 7420849799 / 7482265705</p>
	<p>SUPPORTO SPECCHIO FRONTALE FRONT DOOR MIRROR ARM</p> <p>COS.PEL. ref. SIMILAR ref. 501.07925 7420850409 / 7421346867</p>

AE - Magnum

	<p>VETRO SPECCHIO RISCALDATO - (464X192mm) MIRROR GLASS HEATED - (464X192mm)</p> <p>COS.PEL. ref. SIMILAR ref. 501.89377 5000289377</p> <p style="text-align: right;">DX-SX RH-LH</p>
	<p>VISIERA AE E.4 SPECCHIO FRONTALE CON STAFFE CON STAFFE SUN VISOR MAGNUM E4 WITH BRACKET WITH BRACKETS</p> <p>COS.PEL. ref. SIMILAR ref. 701.19100 7485113512</p>
<p>ADERIMENTI A SCORTE UNTIL SELL-OUF</p> 	<p>CARENATURA LATERALE 1a serie G.R.P. - GRIGIO - (1330mm) FAIRING 1st series G.R.P. - GREY - (1330mm)</p> <p>COS.PEL. ref. SIMILAR ref. 801.11001 5010211001</p> <p style="text-align: right;">DX-SX RH-LH</p>
 	<p>FANALINO LATERALE P21W CORNER LAMP P21W</p> <p>COS.PEL. ref. SIMILAR ref. 1601.23604 5010271807</p> <p style="text-align: right;">DX-SX RH-LH</p>
 	<p>PROIETTORE H1 H7 PY21 W5W - PREDISPOSTO PER CORRETTORE ASSETTO HEADLAMP H1 H7 PY21 W5W - SUITABLE FOR LOAD LEVEL ADJUSTEMENT</p> <p>COS.PEL. ref. SIMILAR ref. 1601.23600 5010544978 / 5010623619</p> <p style="text-align: right;">DX RH</p> <p>1601.23601 5010623620</p> <p style="text-align: right;">SX LH</p>
 	<p>FENDINEBBIA H1 FOGLAMP H1</p> <p>COS.PEL. ref. SIMILAR ref. 1601.23603 5010312972 / 7420881197</p> <p style="text-align: right;">DX-SX RH-LH</p>
	<p>MANIGLIA PORTA SENZA CHIAVE DOOR HANDLE WITHOUT KEY</p> <p>COS.PEL. ref. SIMILAR ref. 1701.60600 5010441111 / 7421015813</p> <p style="text-align: right;">DX RH</p> <p>1701.60601 5010353608 / 7421015810</p> <p style="text-align: right;">SX LH</p>
	<p>GUARNIZIONE PARABREZZA WINDSCREEN GASKET</p> <p>COS.PEL. ref. SIMILAR ref. 1801.78000 5001853757</p>

	<p>ALZACRISTALLI ELETTRICO - CON MOTORINO - 2 PIN WINDOW REGULATOR ELECTRIC - WITH MOTOR - 2 PIN</p> <p>COS.PEL. ref. SIMILAR ref. 1901.23600 5010468940 / 7421275875 DX-SX RH-LH</p>
	<p>TIRANTE PARAFANGO POSTERIORE GOMMA - NERO MUDGUARD TENSIONER RUBBER - BLACK</p> <p>COS.PEL. ref. SIMILAR ref. 1001.00001 5001842757</p>
	<p>TIRANTE CALOTTA 3a SERIE GOMMA - NERO MUDGUARD TENSIONER 3rd SERIES RUBBER - BLACK</p> <p>COS.PEL. ref. SIMILAR ref. 1001.14951 5001856184</p>
	<p>TIRANTE PARAFANGO POSTERIORE GOMMA - NERO MUDGUARD TENSIONER 1st SERIES RUBBER - BLACK</p> <p>COS.PEL. ref. SIMILAR ref. 1001.23641 5001823641</p>
	<p>TIRANTE CALOTTA GOMMA - NERO MUDGUARD TENSIONER RUBBER - BLACK</p> <p>COS.PEL. ref. SIMILAR ref. 1002.13005 7421094457</p>
	<p>TIRANTE PARAFANGO GOMMA - NERO MUDGUARD TENSIONER RUBBER - BLACK</p> <p>COS.PEL. ref. SIMILAR ref. 1002.56557 -</p>
	<p>TIRANTE PARAFANGO GOMMA - NERO MUDGUARD TENSIONER RUBBER - BLACK</p> <p>COS.PEL. ref. SIMILAR ref. 1002.56558 7420498623</p>



	<p>FRONTALE SUPERIORE METALLO UPPER FRONT GRILLE STEEL</p> <p>COS.PEL. ref. SIMILAR ref. 101.29099 7484537795</p>
	<p>GRIGLIA CENTRALE P.P. - GRIGIO CENTRAL GRILLE P.P. - GREY</p> <p>COS.PEL. ref. SIMILAR ref. 101.29100 7482219461</p>
	<p>GRIGLIA SUPERIORE (SOLO ACCIAIO) METALLO - NERO UPPER GRILLE (ONLY IRON) METAL - BLACK</p> <p>COS.PEL. ref. SIMILAR ref. 101.29101 7482590340</p>
	<p>GRIGLIA SUPERIORE (SOLO PLASTICA) P.P. - NERO UPPER GRILLE (ONLY PLASTIC) P.P. - BLACK</p> <p>COS.PEL. ref. SIMILAR ref. 101.29102 7482276014</p>
	<p>GRIGLIA INFERIORE (SOLO PLASTICA) P.P. - NERO LOWER GRILLE (ONLY PLASTIC) P.P. - BLACK</p> <p>COS.PEL. ref. SIMILAR ref. 101.29103 7482275869</p>

	<p>GRIGLIA INFERIORE (SOLO ACCIAIO) METALLO - NERO LOWER GRILLE (ONLY IRON) METAL - BLACK</p> <p>COS.PEL. ref. SIMILAR ref. 101.29104 7482295644</p>
	<p>CANTONALE SUPERIORE CABINA ALTA P.P. - BIANCO UPPER PANEL P.P. - WHITE</p> <p>COS.PEL. ref. SIMILAR ref. 101.29106 7482250945 DX RH</p> <p>101.29105 7482221093 SX LH</p>
	<p>COPERCHIO GRIGLIA CENTRALE CABINA ALTA P.P. - BIANCO GRILLE COVER CENTRAL HIGHT CAB P.P. - WHITE</p> <p>COS.PEL. ref. SIMILAR ref. 101.29107 7482220048</p>
	<p>GRIGLIA SUPERIORE CABINA BASSA P.P. - GRIGIO GRILLE UPPER LOW CAB P.P. - GREY</p> <p>COS.PEL. ref. SIMILAR ref. 401.29100 7421321475</p>
	<p>GRIGLIA P.P. - PRIMER GRILLE UPPER ELEMENT LIGHT GRAY W/O WASHER P.P. - PRIMER</p> <p>COS.PEL. ref. SIMILAR ref. 401.29101 7482701283</p>
	<p>GRIGLIA SUPERIORE CON FORI P.P. - GRIGIO SCURO UPPER GRILLE WITH HOLES P.P. - DARK GRAY</p> <p>COS.PEL. ref. SIMILAR ref. 401.29102 7482282217</p>
	<p>ANGOLO PARAURTI METALLO CORNER BUMPER METAL</p> <p>COS.PEL. ref. SIMILAR ref. 401.29106 7482304803 DX RH</p> <p>401.29105 7482304801 SX LH</p>
	<p>SUPPORTO GRIGLIA CENTRALE CENTRAL GRILLE BRACKET</p> <p>COS.PEL. ref. SIMILAR ref. 401.29107 7482275664</p>

T

	<p>RIPAROFANGO MUDGUARD</p> <p>COS.PEL. ref. 202.14202 SIMILAR ref. 7421094406</p> <p style="text-align: right;">DX-SX RH-LH</p>
	<p>PARAFANGO CENTRALE CENTRAL MUDGUARD</p> <p>COS.PEL. ref. 201.29202 SIMILAR ref. 7482557008 DX RH</p> <p>201.29203 7482557005 SX LH</p>
	<p>CALOTTA PARAFANGO CON 4 TIRANTI P.P. - NERO REAR MUDGUARD WITH 4 MUDGUARD TENSIONERS P.P. - BLACK</p> <p>COS.PEL. ref. 201.30546 SIMILAR ref. 7421094390 / 7421094457 DX-SX RH-LH</p> <p>(201.30548 versione senza i tiranti)</p>
	<p>CALOTTA PARAFANGO P.P. - NERO - 2010 REAR MUDGUARD P.P. - BLACK - TYPE 2010</p> <p>COS.PEL. ref. 201.30548 SIMILAR ref. 7421094390 DX-SX RH-LH</p> <p>Tirante : 1002.13005 - (201.30546 versione con i tiranti)</p>
	<p>MEZZO PARAFANGO POSTERIORE (PARTE POSTERIORE) P.P. - NERO REAR MUDGUARD (REAR PART) P.P. - BLACK</p> <p>COS.PEL. ref. 202.13201 SIMILAR ref. 7421094394 DX-SX RH-LH</p>
	<p>MEZZO PARAFANGO POSTERIORE PARTE ANT. P.P. - NERO REAR MUDGUARD FRONT PART P.P. - BLACK</p> <p>COS.PEL. ref. 202.13202 SIMILAR ref. - DX-SX RH-LH</p>
	<p>RIPARO PEDANA P.P. - NERO FOOTSTEP PROTECTION P.P. - BLACK</p> <p>COS.PEL. ref. 301.29106 SIMILAR ref. 7482574779 DX RH</p> <p>301.29107 7482574778 SX LH</p>
	<p>PEDANA P.P. - NERO STEP PANEL P.P. - BLACK</p> <p>COS.PEL. ref. 301.29100 SIMILAR ref. 7482574837 DX RH</p> <p>301.29101 7482574835 SX LH</p> <p>Griglia/Grille: 301.29104 inf/sup - 301.29105 solo inf/only inf</p> <p>Griglia/Grille: 301.29104 inf/sup - 301.29105 solo inf/only inf</p>









	<p>TAPPO PEDANA P.P. - NERO COVER FOR STEP PANEL P.P. - BLACK COS.PEL. ref. SIMILAR ref. 301.29102 7482282309 DX RH</p> <p>301.29103 7482275889 SX LH</p>
	<p>PEDANA SUPERIORE/INFERIORE P.P. - NERO UPPER/LOWER FOOTSTEP P.P. - BLACK COS.PEL. ref. SIMILAR ref. 301.29104 7482275624 DX-SX RH-LH</p>
	<p>PEDANA INFERIORE P.P. - NERO LOWER FOOTSTEP P.P. - BLACK COS.PEL. ref. SIMILAR ref. 301.29105 7482148692 DX-SX RH-LH</p>
	<p>GRIGLIA PEDANA SUPERIORE UPPER FOOTSTEP GRILLE COS.PEL. ref. SIMILAR ref. 301.29108 7482575895 DX-SX RH-LH</p>
	<p>GRIGLIA PEDANA INFERIORE LOWER FOOTSTEP GRILLE COS.PEL. ref. SIMILAR ref. 301.29109 7482231340 DX-SX RH-LH</p>
	<p>PEDANA PARAFANGO CABINA ALTA MUDGUARD FOOTSTEP HIGH SLEEPER CAB COS.PEL. ref. SIMILAR ref. 301.29110 7482577387 DX RH</p> <p>301.29111 7482577386 SX LH</p>
	<p>PEDANA PARAFANGO CABINA MEDIA E BASSA MUDGUARD FOOTSTEP SLEEPER AND DAY CAB COS.PEL. ref. SIMILAR ref. 301.29112 7482223396 DX RH</p> <p>301.29113 7482214695 SX LH</p>
	<p>ANGOLO PARAURTI SUPERIORE CON FORO FENDI A.B.S. - NERO UPPER CORNER BUMPER WITH FOG LAMP HOLE A.B.S. - BLACK COS.PEL. ref. SIMILAR ref. 401.29094 7482342591 DX RH</p> <p>401.29095 7482342590 SX LH</p>

T

	<p>TAPPO PARAURTI P.P. - NERO BUMPER COVER P.P. - BLACK</p> <p>COS.PEL. ref. SIMILAR ref. 401.29096 7482282179</p> <p>401.29097 7482282172</p> <p style="text-align: right;">DX RH</p> <p style="text-align: right;">SX LH</p>
	<p>ELEMENTO PARAURTI P.P. - GRIGIO MET. FRONT BUMPER P.P. - MET. GRAY</p> <p>COS.PEL. ref. SIMILAR ref. 401.29098 7421321542</p> <p>401.29099 7421321562</p> <p style="text-align: right;">DX RH</p> <p style="text-align: right;">SX LH</p>
	<p>CANTONALE PARAURTI P.P. CORNER BUMPER P.P.</p> <p>COS.PEL. ref. SIMILAR ref. 401.29090 7482567574</p> <p>401.29091 Tappo/Cover: 401.29092 7482567573</p> <p style="text-align: right;">DX RH</p> <p style="text-align: right;">SX LH</p> <p style="text-align: center;">Tappo/Cover: 401.29092</p>
	<p>TAPPO PER CANTONALE PARAURTI P.P. - Per 401.29090/1 COVER P.P. - For 401.29090/1</p> <p>COS.PEL. ref. SIMILAR ref. 401.29092 7482567551</p> <p style="text-align: right;">DX-SX RH-LH</p>
	<p>PARAURTI CENTRALE P.P. CENTRAL BUMPER P.P.</p> <p>COS.PEL. ref. SIMILAR ref. 401.29093 7482282197 / 7484575384</p>
	<p>COPERCHIO RETROVISORE GRIGIO - PICCOLO MIRROR COVER GREY - SMALL</p> <p>COS.PEL. ref. SIMILAR ref. 501.29500 7482408492</p> <p>501.29501 7482408447</p> <p style="text-align: right;">DX RH</p> <p style="text-align: right;">SX LH</p>
	<p>COPERCHIO RETROVISORE GRIGIO - GRANDE MIRROR COVER GREY - BIG</p> <p>COS.PEL. ref. SIMILAR ref. 501.29502 7482408493</p> <p>501.29503 7482408449</p> <p style="text-align: right;">DX RH</p> <p style="text-align: right;">SX LH</p>
	<p>SPECCHIO GRANDE MIRROR BIG</p> <p>COS.PEL. ref. SIMILAR ref. 501.29504 7482408450</p> <p style="text-align: right;">DX-SX RH-LH</p>









	<p>SPECCHIO PICCOLO MIRROR SMALL</p> <p>COS.PEL. ref. SIMILAR ref. 501.29505 7482408451</p> <p style="text-align: right;">DX-SX RH-LH</p>
	<p>SPECCHIO RETROVISORE GRIGIO REAR-VIEW MIRROR GREY</p> <p>COS.PEL. ref. SIMILAR ref. 501.29506 7482582181</p> <p style="text-align: right;">DX RH</p> <p>501.29507 7482582213</p> <p style="text-align: right;">SX LH</p>
	<p>SEDE SPECCHIO GRANDE BIG MIRROR FRAME</p> <p>COS.PEL. ref. SIMILAR ref. 501.29508 7482408487</p> <p style="text-align: right;">DX RH</p> <p>501.29509 7482408433</p> <p style="text-align: right;">SX LH</p>
	<p>SEDE SPECCHIO PICCOLA SMALL MIRROR FRAME</p> <p>COS.PEL. ref. SIMILAR ref. 501.29510 7482408488</p> <p style="text-align: right;">DX RH</p> <p>501.29511 7482408435</p> <p style="text-align: right;">SX LH</p>
	<p>COPRIBRACCIO SUPERIORE UPPER MIRROR ARM COVER</p> <p>COS.PEL. ref. SIMILAR ref. 501.29512 7482408482</p> <p style="text-align: right;">DX RH</p> <p>501.29513 7482408426</p> <p style="text-align: right;">SX LH</p>
	<p>COPRIBRACCIO INFERIORE LOWER MIRROR ARM COVER</p> <p>COS.PEL. ref. SIMILAR ref. 501.29514 7482574172</p> <p style="text-align: right;">DX RH</p> <p>501.29515 7482574171</p> <p style="text-align: right;">SX LH</p>
	<p>VISIERA SUN VISOR</p> <p>COS.PEL. ref. SIMILAR ref. 701.29700 7482366153</p> <p style="text-align: right;">Relativo kit staffe 1001.29700</p>
	<p>COPRIBATTERIA LATERALE P.P. SIDE BATTERY COVER P.P.</p> <p>COS.PEL. ref. SIMILAR ref. 1001.29100 7422078106</p> <p style="text-align: right;">TRATTORE / TRACTOR</p>

T

	<p>SUPPORTO ANGOLO PARAURTI CORNER BUMPER BRACKET</p> <p>COS.PEL. ref. SIMILAR ref. 1001.29102 7482376967</p> <p>1001.29101 7482376965</p> <p style="text-align: right;">DX RH SX LH</p>
	<p>SUPPORTO FARO HEAD LAMP HOUSING BRACKET</p> <p>COS.PEL. ref. SIMILAR ref. 1001.29104 7482585433</p> <p>1001.29103 7482585431</p> <p style="text-align: right;">DX RH SX LH</p>
	<p>SUPPORTO STEP PANEL BRACKET</p> <p>COS.PEL. ref. SIMILAR ref. 1001.29106 7482587401 / 7484539338</p> <p>1001.29105 7482560239</p> <p style="text-align: right;">DX RH SX LH</p>
	<p>TUBO FISSAGGIO PARAFANGO POST. PARTE ANT. CON GOMMINO - CM 56 REAR SUPPORT BRACKET FRONT PART WITH RUBBER - CM 56</p> <p>COS.PEL. ref. SIMILAR ref. 1001.30102 7421094410</p>
	<p>STAFFA PARAFANGO POSTERIORE LUNGA METALLO - NERO REAR MUDGUARD BRACKET METAL - BLACK</p> <p>COS.PEL. ref. SIMILAR ref. 1001.30103 7421094456</p>
	<p>STAFFA PARAFANGO POSTERIORE METALLO - NERO REAR MUDGUARD BRACKET METAL - BLACK</p> <p>COS.PEL. ref. SIMILAR ref. 1001.30104 7421094454</p>
	<p>SUPPORTO PARAFANGO POSTERIORE PICCOLO ALLUMINIO REAR MUDGUARD BRACKET ALUMINIUM</p> <p>COS.PEL. ref. SIMILAR ref. 1002.13006 7421090272</p>
	<p>SUPPORTO PARAFANGO POSTERIORE GRANDE ALLUMINIO REAR MUDGUARD BRACKET ALUMINIUM</p> <p>COS.PEL. ref. SIMILAR ref. 1002.13007 7421213203</p>

 <p>cm 63</p>	<p>TUBO FISSAGGIO PARAFANGO METALLO - CM 63 REAR MUDGUARD BRACKET STEEL - CM 63</p> <p>COS.PEL. ref. SIMILAR ref. 1002.13008 7421094413</p>
	<p>RIPARO CORNICE FARO P.P. PROTECTING PLATE FOR BEZEL P.P.</p> <p>COS.PEL. ref. SIMILAR ref. 1101.29800 7482585426</p> <p>1101.29801 7482585425</p> <p style="text-align: right;">DX RH</p> <p style="text-align: right;">SX LH</p>
	<p>SUPPORTO CORNICE FARO HEAD LAMP HOUSING</p> <p>COS.PEL. ref. SIMILAR ref. 1101.29802 7482291434</p> <p>1101.29803 7482291437</p> <p style="text-align: right;">DX RH</p> <p style="text-align: right;">SX LH</p>
	<p>SOTTOPORTA PARTE ESTERNA CABINA ALTA OUTER EXTENSION DOOR HIGH SLEEPER CAB</p> <p>COS.PEL. ref. SIMILAR ref. 1401.29500 7482510549</p> <p>1401.29501 7482510548</p> <p style="text-align: right;">DX RH</p> <p style="text-align: right;">SX LH</p>
	<p>SOTTOPORTA PARTE INTERNA CABINA ALTA INNER EXTENSION DOOR HIGH SLEEPER CAB</p> <p>COS.PEL. ref. SIMILAR ref. 1401.29502 7482517788</p> <p>1401.29503 7482517786</p> <p style="text-align: right;">DX RH</p> <p style="text-align: right;">SX LH</p>
	<p>SOTTOPORTA PARTE ESTERNA CABINA MEDIA E BASSA OUTER EXTENSION DOOR SLEEPER AND DAY CAB</p> <p>COS.PEL. ref. SIMILAR ref. 1401.29504 7482510542</p> <p>1401.29505 7482510540</p> <p style="text-align: right;">DX RH</p> <p style="text-align: right;">SX LH</p>
	<p>SOTTOPORTA PARTE INTERNA CABINA MEDIA E BASSA INNER EXTENSION DOOR SLEEPER AND DAY CAB</p> <p>COS.PEL. ref. SIMILAR ref. 1401.29506 7482516638</p> <p>1401.29507 7482516626</p> <p style="text-align: right;">DX RH</p> <p style="text-align: right;">SX LH</p>
 	<p>PROIETTORE H1 H7 P21W W5W - CORRETTORE ASSETTO MANUALE HEADLAMP H1 H7 P21W W5W - MANUAL LOAD LEVEL ADJUSTEMENT</p> <p>COS.PEL. ref. SIMILAR ref. 1601.29800 7482622151 / 7482622240</p> <p>1601.29801 7482622235 / 7482622242</p> <p style="text-align: right;">DX RH</p> <p style="text-align: right;">SX LH</p>

T

	<p>PROIETTORE H7 H1 LED HEADLAMP H7 H1 LED</p> <p>COS.PEL. ref. SIMILAR ref. 1601.29802 7482622272</p> <p>1601.29803 7482622276</p> <p style="text-align: right;">DX RH</p> <p style="text-align: right;">SX LH</p>
	<p>FENDINEBBIA FOG LAMP</p> <p>COS.PEL. ref. SIMILAR ref. 1601.29804 7482252916</p> <p>1601.29805 7482252914</p> <p style="text-align: right;">DX RH</p> <p style="text-align: right;">SX LH</p>
	<p>MANIGLIA PORTA SENZA CHIAVE SENZA CHIAVE DOOR HANDLE WITHOUT KEY WITHOUT KEY</p> <p>COS.PEL. ref. SIMILAR ref. 1701.29700 7482275921</p> <p>1701.29701 7482275772</p> <p style="text-align: right;">DX RH</p> <p style="text-align: right;">SX LH</p>
	<p>BLOCCHETTO CON CHIAVI CON CHIAVI LOCK CYLINDER WITH KEYS WITH KEYS</p> <p>COS.PEL. ref. SIMILAR ref. 1701.29702 7423005983</p> <p>1701.29703 7423005984</p> <p style="text-align: right;">DX RH</p> <p style="text-align: right;">SX LH</p>
	<p>CERNIERA INFERIORE LOWER HINGE</p> <p>COS.PEL. ref. SIMILAR ref. 1701.29708 7482589732</p> <p>1701.29709 7482589730</p> <p style="text-align: right;">DX RH</p> <p style="text-align: right;">SX LH</p>
	<p>CERNIERA HINGE</p> <p>COS.PEL. ref. SIMILAR ref. 1701.29710 7482232463</p> <p>1701.29711 7482230393</p> <p style="text-align: right;">DX RH</p> <p style="text-align: right;">SX LH</p>
	<p>DEFLETTORI LATERALI SIDEWINDOW DEFLECTORS</p> <p>COS.PEL. ref. SIMILAR ref. 3001.29000 7484539407</p>
	<p>KIT PER CONNESSIONI ELETTRICHE Connettore AMP 1,5 singolo KIT FOR ELECTRICAL JOINTS Connector AMP 1,5 simple</p> <p>COS.PEL. ref. SIMILAR ref. 003120 -</p>

 <p style="text-align: center;">cm 16</p>	<p>FANALE COMPLETO REAR LIGHTING 7 FUNZIONI - CONNETTORE LATERALE AMP 1.5 7 FUNCTIONS - LATERAL CONNECTOR AMP 1.5</p> <p>COS.PEL. ref. SIMILAR ref. 1501.30000 7420802350 DX RH Relativo connettore 003120 1501.30001 7420802348 SX LH Con luce targa / With plate light (ex 006015) - Conn. 003120 TRASPARENTE / LENS 1501.30100 7420802418 (ex 010082) DX-SX RH-LH</p>
 <p style="text-align: center;">cm 16</p>	<p>FANALE POSTERIORE REAR-LIGHT 7 FUNZIONI - CONNETTORE LATERALE AMP 1.5 7 FUNCTIONS - LATERAL CONNECTOR AMP 1.5</p> <p>COS.PEL. ref. SIMILAR ref. 1501.30002 7420802353 DX RH Con cicalino / With buzzer (ex 006016) - Connettore 003120 TRASPARENTE / LENS 1501.30100 7420802418 (ex 010082) DX-SX RH-LH</p>
 <p style="text-align: center;">cm 16</p>	<p>FANALE POSTERIORE REAR-LIGHT LED - 24V - CONNETTORE LATERALE AMP 1.5 LED - 24V - LATERAL CONNECTOR AMP 1.5</p> <p>COS.PEL. ref. SIMILAR ref. 1502.14000 - DX RH Relativo connettore 003120 1502.14001 7425982261 SX LH Con luce targa / With plate light - Relativo connettore 003120 TRASPARENTE / LENS 1502.14100 7422800391 DX-SX RH-LH</p>
 <p style="text-align: center;">cm 16</p>	<p>FANALE POSTERIORE REAR-LIGHT LED - 24V - CONNETTORE LATERALE AMP 1.5 LED - 24V - LATERAL CONNECTOR AMP 1.5</p> <p>COS.PEL. ref. SIMILAR ref. 1502.14002 7425982262 DX RH Con cicalino / With buzzer - Relativo connettore 003120 TRASPARENTE / LENS 1502.14100 7422800391 DX-SX RH-LH</p>







Parti di ricambio adattabili a:
Spare parts suitable to:



	<p>PEDANA P.P.G.F. - GRIGIO SCURO FOOTSTEP P.P.G.F. - DARK GREY COS.PEL. ref. SIMILAR ref. 301.53000 20538003 DX RH</p> <p>301.53001 Griglia/Grille : 1001.53100 20538006 SX LH Griglia/Grille : 1001.53101</p>
	<p>PARAURTI ANTERIORE FRONT BUMPER COS.PEL. ref. SIMILAR ref. 402.12090 20961733</p>
	<p>VETRO SPECCHIO INFERIORE RISCALDATO LOWER MIRROR GLASS HEATED COS.PEL. ref. SIMILAR ref. 501.30400 20862795 DX-SX RH-LH</p>
	<p>COPERCHIO RETROVISORE SUPERIORE NERO UPPER REAR-VIEW MIRROR COVER BLACK COS.PEL. ref. SIMILAR ref. 501.30405 20862779 DX-SX RH-LH</p>
	<p>COPERCHIO GRANDANGOLO NERO (PREMIUM DISTRIBUZIONE) COVER WIDE ANGLE BLACK (PREMIUM DISTRIBUTION) COS.PEL. ref. SIMILAR ref. 501.31500 20862800 DX-SX RH-LH</p>

	<p>VETRO SPECCHIO G.A. DISTRIBUZIONE RISCALDATO GLASS WIDE ANGLE DISTIBUTION HEATED COS.PEL. ref. SIMILAR ref. 501.31504 20862810 DX RH</p> <p>501.31503 20862815 SX LH</p>
	<p>SPECCHIO RETROVISORE ELETTRICO - RISCALDATO - NERO - BRACCIO CORTO 100 REAR-VIEW MIRROR ELECTRIC - HEATED - BLACK - SHORT ARM 100 COS.PEL. ref. SIMILAR ref. 501.31506 20703983 / 21326527 DX RH</p> <p>501.31505 20207881 / 20707881 / 20903722 SX LH</p>
	<p>GRIGLIA PEDANA INFERIORE P.P.G.F. - NERA LOWER FOOTSTEP GRILLE P.P.G.F. - BLACK COS.PEL. ref. SIMILAR ref. 1001.53100 20538011 DX RH</p> <p>1001.53101 20538012 SX LH</p>
	<p> PROIETTORE H4 PY21W W5W - PREDISPOSTO PER CORRETTORE ASSETTO HEADLAMP H4 PY21W W5W - SUITABLE FOR LOAD LEVEL ADJUSTEMENT COS.PEL. ref. SIMILAR ref. 1602.12700 20818771 DX RH</p> <p>1602.12701 20818763 SX LH</p>
	<p>ARRESTO PORTA DOOR STOP</p> <p>COS.PEL. ref. SIMILAR ref. 1702.13700 21350581 DX-SX RH-LH</p>
	<p>DEFLETTORI LATERALI CON CLIPS SIDEWINDOW DEFLECTORS WITH CLIPS</p> <p>COS.PEL. ref. SIMILAR ref. 3002.00002 -</p>



	<p>PEDANA P.P.G.F. - GRIGIO SCURO - 10-05> FOOTSTEP P.P.G.F. - DARK GREY - 10-05></p> <p>COS.PEL. ref. SIMILAR ref. 302.30004 20593734</p> <p>Griglia/Grille : 1001.53100 inf - 1001.53102 sup</p> <p style="text-align: right;">DX RH</p>
<p>AD ESAURIMENTO SCORTE UNTIL SELL-OUT</p> 	<p>RIPARO PEDANA H.D.PE. - NERO FOOTSTEP PROTECTION H.D.PE. - BLACK</p> <p>COS.PEL. ref. SIMILAR ref. 302.30006 20593731</p> <p style="text-align: right;">DX RH</p>
	<p>PEDANA P.P.G.F. - GRIGIO SCURO - 10-05> FOOTSTEP P.P.G.F. - DARK GREY - 10-05></p> <p>COS.PEL. ref. SIMILAR ref. 301.30004 20593735</p> <p>301.30003 Griglia/Grille: 1001.53100 inf - 1001.53102 sup 20593721</p> <p>Griglia/Grille: 1001.53101 inf - 1001.53103 sup</p> <p style="text-align: right;">DX RH SX LH</p>
	<p>ANGOLO SOTTOPARAURTI P.P. - GRIGIO - 10-05> CORNER SPOILER P.P. - GREY - 10-05></p> <p>COS.PEL. ref. SIMILAR ref. 401.30604 25369343</p> <p>401.30603 25369342</p> <p style="text-align: right;">DX RH SX LH</p>
	<p>SOTTOPARAURTI CENTRALE P.P. - GRIGIO - 10-05> CENTRAL SPOILER P.P. - GREY - 10-05></p> <p>COS.PEL. ref. SIMILAR ref. 401.30605 25369341</p>

	<p>VETRO SPECCHIO INFERIORE RISCALDATO LOWER MIRROR GLASS HEATED</p> <p>COS.PEL. ref. SIMILAR ref. 501.30400 20862795</p> <p style="text-align: right;">DX-SX RH-LH</p>
	<p>COPERCHIO RETROVISORE SUPERIORE NERO UPPER REAR-VIEW MIRROR COVER BLACK</p> <p>COS.PEL. ref. SIMILAR ref. 501.30405 20862779</p> <p style="text-align: right;">DX-SX RH-LH</p>
	<p>COPPA CON MOTORINO HOUSING WITH MOTOR</p> <p>COS.PEL. ref. SIMILAR ref. 501.30406 20862782</p> <p style="text-align: right;">DX-SX RH-LH</p>
	<p>COPERCHIO GRANDANGOLO NERO (PREMIUM DISTRIBUZIONE) COVER WIDE ANGLE BLACK (PREMIUM DISTRIBUTION)</p> <p>COS.PEL. ref. SIMILAR ref. 501.31500 20862800</p> <p style="text-align: right;">DX-SX RH-LH</p>
	<p>COPPA G.A. PREMIUM DISTRIBUZIONE HOUSING WIDE ANGLE PREMIUM DISTRIBUTION</p> <p>COS.PEL. ref. SIMILAR ref. 501.31502 20862813</p> <p style="text-align: right;">DX RH</p> <p>501.31501 20862809</p> <p style="text-align: right;">SX LH</p>
	<p>VETRO SPECCHIO G.A. DISTRIBUZIONE RISCALDATO GLASS WIDE ANGLE DISTIBUTION HEATED</p> <p>COS.PEL. ref. SIMILAR ref. 501.31504 20862810</p> <p style="text-align: right;">DX RH</p> <p>501.31503 20862815</p> <p style="text-align: right;">SX LH</p>
	<p>SPECCHIO RETROVISORE ELETTRICO - RISCALDATO - NERO - BRACCIO CORTO 100 REAR-VIEW MIRROR ELECTRIC - HEATED - BLACK - SHORT ARM 100</p> <p>COS.PEL. ref. SIMILAR ref. 501.31506 20703983 / 21326527</p> <p style="text-align: right;">DX RH</p> <p>501.31505 20207881 / 20707881 / 20903722</p> <p style="text-align: right;">SX LH</p>
	<p>SPECCHIO RETROVISORE ELETTRICO - RISCALDATO - NERO - BRACCIO LUNGO 200 REAR-VIEW MIRROR ELECTRIC - HEATED - BLACK - LONG ARM 200</p> <p>COS.PEL. ref. SIMILAR ref. 501.31508 20708303 / 21326526 / 21475603</p> <p style="text-align: right;">DX RH</p> <p>501.31507 20707874</p> <p style="text-align: right;">SX LH</p>

ALL ITEMS MENTIONED IN OUR CATALOGUE ARE NOT ORIGINAL PARTS BUT PERFECTLY INTERCHANGEABLE WITH THEM.

GOVERNING LEGISLATIONS FOR THE SALE OF OUR PRODUCTS DIFFER IN EACH COUNTRY.

INFRINGEMENTS, IF ANY, OF LOCAL LEGISLATIONS ARE RESPONSIBILITY OF THE RETAILER IN THE COUNTRY OF FINAL DISTRIBUTION.



	<p>BRACCIO SPECCHIO LUNGO BRACCIO LUNGO 200 - FORNITO DI CAVI MIRROR BRACKET LONG LONG ARM 200 - WITH CABLES COS.PEL. ref. SIMILAR ref. 501.31510 20903723 DX RH</p> <p>501.31509 20903732 SX LH</p>
	<p>BRACCIO SPECCHIO CORTO BRACCIO CORTO 100 MIRROR BRACKET SHORT SHORT ARM 100 COS.PEL. ref. SIMILAR ref. 501.31512 20903727 DX RH</p> <p>501.31511 20903722 SX LH</p>
 <p>cm 194 cm 28</p>	<p>VISIERA TETTO BASSO CON SPECCHIO FRONTALE LOW ROOF SUN VISION WITH FRONT MIRROR COS.PEL. ref. SIMILAR ref. 701.53104 20937431</p> <p>Relativo kit staffe 1001.53104</p>
	<p>GRIGLIA PEDANA INFERIORE P.P.G.F. - NERA LOWER FOOTSTEP GRILLE P.P.G.F. - BLACK COS.PEL. ref. SIMILAR ref. 1001.53100 20538011 DX RH</p> <p>1001.53101 20538012 SX LH</p>
	<p>GRIGLIA PEDANA SUPERIORE / INFERIORE P.P.G.F. - NERA UPPER / LOWER FOOTSTEP GRILLE P.P.G.F. - BLACK COS.PEL. ref. SIMILAR ref. 1001.53102 20538248 DX RH</p> <p>1001.53103 20538247 SX LH</p>
	<p>PORTALAMPADA Relativo connettore 003121 LAMP BULB HOLDER Related connector 003121 COS.PEL. ref. SIMILAR ref. 1601.50015 20745227</p> <p>Per lampada / For lamp : 1601.50018 / 1604.55001</p>
 	<p>FANALINO LATERALE R5W SIDE LAMP R5W COS.PEL. ref. SIMILAR ref. 1601.50018 21103284 DX-SX RH-LH</p> <p>Portalampada/Lamp holder : 1601.50015</p>
 	<p>FENDINEBBIA H11 FOG LAMP H11 COS.PEL. ref. SIMILAR ref. 1602.12702 20779458 DX-SX RH-LH</p>

	<p>MANIGLIA PORTA SENZA CHIAVE DOOR HANDLE WITHOUT KEY COS.PEL. ref. SIMILAR ref. 1701.53600 24426875 DX RH</p> <p>1701.53601 24426873 SX LH</p>
	<p>ARRESTO PORTA DOOR STOP COS.PEL. ref. SIMILAR ref. 1702.13700 21350581 DX-SX RH-LH</p>
	<p>ALZACRISTALLI ELETTRICO - CON MOTORINO - 2 PIN WINDOW REGULATOR ELECTRIC - WITH MOTOR - 2 PIN COS.PEL. ref. SIMILAR ref. 1901.30702 82497194 DX RH</p> <p>1901.30703 82497193 SX LH</p>
	<p>DEFLETTORI LATERALI CON CLIPS SIDEWINDOW DEFLECTORS WITH CLIPS COS.PEL. ref. SIMILAR ref. 3002.00002 -</p>
	<p>KIT PER CONNESSIONI ELETTRICHE Connettore AMP 1,5 singolo KIT FOR ELECTRICAL JOINTS Connector AMP 1,5 simple COS.PEL. ref. SIMILAR ref. 003120 -</p>
	<p>KIT PER CONNESSIONI ELETTRICHE Connettore 3 vie JPT KIT FOR ELECTRICAL JOINTS Connector 3 ways JPT COS.PEL. ref. SIMILAR ref. 003121 - Connettore per 1601.50015</p>
	<p>FANALE POSTERIORE 5 FUNZIONI - CONNETTORE POSTERIORE AMP 1.5 REAR-LIGHT 5 FUNCTIONS - REAR CONNECTOR AMP 1.5 COS.PEL. ref. SIMILAR ref. 1501.03000 20769784 DX RH 1501.03001 20769783 SX LH (ex 007880/007900) - Connettore 003120 TRASPARENTE / LENS Con luce targa / W. plate light (ex 007880/007900) - Conn. 003120 1501.03100 20537280 (ex 011591) DX-SX RH-LH</p>

F-L Euro 6



	<p>GRIGLIA FRONTALE FRONT GRILLE</p> <p>COS.PEL. ref. SIMILAR ref. 102.31100 21849913</p>
	<p>GRIGLIA GRILLE</p> <p>COS.PEL. ref. SIMILAR ref. 102.31101 82523575</p>
	<p>PEDANA P.P.G.F. - GRIGIO SCURO FOOTSTEP P.P.G.F. - DARK GREY</p> <p>COS.PEL. ref. SIMILAR ref. 301.53000 20538003 DX RH</p> <p>301.53001 Griglia/Grille : 1001.53100 20538006 SX LH</p> <p>Griglia/Grille : 1001.53101</p>
	<p>PARAURTI ANTERIORE FRONT BUMPER</p> <p>COS.PEL. ref. SIMILAR ref. 402.31090 22376336 / 82642339</p>
	<p>COPRIPARAURTI BUMPER COVER</p> <p>COS.PEL. ref. SIMILAR ref. 402.31091 84000742</p>

	<p>ANGOLO PARAURTI CON FORO METALLO - NERO CORNER BUMPER WITH HOLE METAL - BLACK COS.PEL. ref. SIMILAR ref.</p> <p>402.31092 82523848 DX RH</p> <p>402.31093 82523847 SX LH</p>
	<p>ANGOLO PARAURTI METALLO - NERO CORNER BUMPER METAL - BLACK COS.PEL. ref. SIMILAR ref.</p> <p>402.31094 82992302 DX RH</p> <p>402.31095 82992301 SX LH</p>
	<p>ANGOLO PARAURTI CORNER BUMPER</p> <p>COS.PEL. ref. SIMILAR ref.</p> <p>402.31096 82531174 DX RH</p> <p>402.31097 82524665 SX LH</p>
	<p>CORNICE FENDINEBBIA FOG LAMP FRAME</p> <p>COS.PEL. ref. SIMILAR ref.</p> <p>402.31098 82534529 DX RH</p> <p>402.31099 82534527 SX LH</p>
 <p>cm 194</p> <p>cm 28</p>	<p>VISIERA TETTO BASSO CON SPECCHIO FRONTALE LOW ROOF SUN VISION WITH FRONT MIRROR</p> <p>COS.PEL. ref. SIMILAR ref.</p> <p>701.53104 20937431</p> <p>Relativo kit staffe 1001.53104</p>
	<p>CONVOGLIATORE ARIA PARTE INTERNA INNER PANEL CORNER</p> <p>COS.PEL. ref. SIMILAR ref.</p> <p>902.31600 21849885 DX RH</p> <p>902.31601 21849884 SX LH</p>
	<p>CONVOGLIATORE ARIA PARTE ESTERNA OUTER PANEL CORNER</p> <p>COS.PEL. ref. SIMILAR ref.</p> <p>902.31602 21849909 DX RH</p> <p>902.31603 21849897 SX LH</p>
	<p>GRIGLIA PEDANA INFERIORE P.P.G.F. - NERA LOWER FOOTSTEP GRILLE P.P.G.F. - BLACK COS.PEL. ref. SIMILAR ref.</p> <p>1001.53100 20538011 DX RH</p> <p>1001.53101 20538012 SX LH</p>

F-L Euro 6

 	<p>PROIETTORE H7,PY21W - LED HEADLAMP H7,PY21W - LED COS.PEL. ref. 1602.31600 SIMILAR ref. 82532284 DX RH</p> <p>1602.31601 82526640 SX LH</p>
	<p>FANALE POSTERIORE REAR-LIGHT LED - 24V - CONNETTORE LATERALE AMP 1.5 LED - 24V - LATERAL CONNECTOR AMP 1.5 COS.PEL. ref. 1502.14004 SIMILAR ref. 21735299 / 84441937 DX RH Relativo connettore 003120 1502.14003 21735301 / 84441936 SX LH Relativo connettore 003120 TRASPARENTE / LENS 1502.14101 84122332 DX-SX RH-LH</p>
	<p>FANALE POSTERIORE REAR-LIGHT LED - 24V - CONNETTORE LATERALE AMP 1.5 LED - 24V - LATERAL CONNECTOR AMP 1.5 COS.PEL. ref. 1502.14006 SIMILAR ref. 82483073 / 84441760 DX RH Con cicalino / With buzzer - Relativo connettore 003120 1502.14005 82483074 / 84441759 SX LH Con luce targa / With plate light - Relativo connettore 003120 TRASPARENTE / LENS 1502.14101 84122332 DX-SX RH-LH</p>



	<p>GRIGLIA INFERIORE A.B.S. - NERO LOWER GRILLE A.B.S. - BLACK</p> <p>COS.PEL. ref. SIMILAR ref. 102.44482 1063509 / 8144482</p>
	<p>GRIGLIA SUPERIORE METALLO UPPER GRILLE METAL</p> <p>COS.PEL. ref. SIMILAR ref. 102.64100 8191421</p>
	<p>GRIGLIA ANTERIORE P.P. - NERO FRONT GRILLE P.P. - BLACK</p> <p>COS.PEL. ref. SIMILAR ref. 102.64101 8191406</p>
	<p>PEDANA PARAFANGO P.P. - GRIGIO MUDGUARD FOOTSTEP P.P. - GREY</p> <p>COS.PEL. ref. SIMILAR ref. 202.65200 20529483 / 3175159 DX RH</p> <p>202.65201 20425469 / 20529478 / 20537185 / 3175158 SX LH</p>
	<p>SPORTELLINO PEDANA A.B.S. - GRIGIO COVER FOOTSTEP A.B.S. - GREY</p> <p>COS.PEL. ref. SIMILAR ref. 202.65202 20529765 / 3981043 DX-SX RH-LH</p>

F-M 7-10-12





	<p>VASCETTA PEDANA A.B.S. - GRIGIO FOOTSTEP A.B.S. - GREY COS.PEL. ref. SIMILAR ref. 302.64300 1062134 / 8191594</p> <p>302.64301 1062133 / 8191593</p> <p style="text-align: right;">DX RH</p> <p style="text-align: right;">SX LH</p>
	<p>PARAURTI ANTERIORE METALLO FRONT BUMPER METAL</p> <p>COS.PEL. ref. SIMILAR ref. 402.89329 8144454 / 8189329</p>
	<p>SOTTOPARAURTI A.B.S. - NERO SPOILER A.B.S. - BLACK</p> <p>COS.PEL. ref. SIMILAR ref. 402.88888 3981256 / 8152722 / 8189337</p>
	<p>PEDANA PARAURTI METALLO FRONT BUMPER FOOTSTEP METAL</p> <p>COS.PEL. ref. SIMILAR ref. 402.89328 1626680 / 20372227</p> <p>402.89327 1626679 / 20372226</p> <p style="text-align: right;">DX RH</p> <p style="text-align: right;">SX LH</p>
	<p>RIPARO CORNICE FARO A.B.S. - NERO PROTECTING PLATE FOR HEADLIGHT BEZEL A.B.S. - BLACK</p> <p>COS.PEL. ref. SIMILAR ref. 1102.41290 8141290</p> <p>1102.41289 8141289</p> <p style="text-align: right;">DX RH</p> <p style="text-align: right;">SX LH</p>
	<p>CORNICE FARO A.B.S. - NERO LAMP BEZEL A.B.S. - BLACK</p> <p>COS.PEL. ref. SIMILAR ref. 1102.64500 20398388 / 20398390 / 81915870</p> <p>1102.64501 1062163 / 20398387 / 20398389</p> <p style="text-align: right;">DX RH</p> <p style="text-align: right;">SX LH</p>
	<p>PANNELLO ANGOLARE METALLO CORNER PANEL METAL</p> <p>COS.PEL. ref. SIMILAR ref. 1202.64700 8191412</p> <p>1202.64701 8191409</p> <p style="text-align: right;">DX RH</p> <p style="text-align: right;">SX LH</p>
	<p>DEFLETTORI LATERALI CON CLIPS SIDEWINDOW DEFLECTORS WITH CLIPS</p> <p>COS.PEL. ref. SIMILAR ref. 3002.00001 -</p>



	<p>GRIGLIA SUPERIORE P.P.G.F. - BIANCO UPPER GRILLE P.P.G.F. - WHITE</p> <p>COS.PEL. ref. SIMILAR ref. 102.65100 3175376</p>
	<p>PEDANA PARAFANGO P.P. - GRIGIO MUDGUARD FOOTSTEP P.P. - GREY</p> <p>COS.PEL. ref. SIMILAR ref. 202.65200 20529483 / 3175159</p> <p>202.65201 20425469 / 20529478 / 20537185 / 3175158</p> <p style="text-align: right;">DX RH</p> <p style="text-align: right;">SX LH</p>
	<p>SPORTELLLO PEDANA A.B.S. - GRIGIO COVER FOOTSTEP A.B.S. - GREY</p> <p>COS.PEL. ref. SIMILAR ref. 202.65202 20529765 / 3981043</p> <p style="text-align: right;">DX-SX RH-LH</p>
	<p>PARAURTI CENTRALE P.P.T. - NERO CENTRAL BUMPER P.P.T. - BLACK</p> <p>COS.PEL. ref. SIMILAR ref. 402.75000 20529740 / 3175417</p>
	<p>ANGOLO PARAURTI P.P. - NERO CORNER BUMPER P.P. - BLACK</p> <p>COS.PEL. ref. SIMILAR ref. 402.75002 20529742 / 3175419</p> <p style="text-align: right;">DX RH</p> <p style="text-align: right;">402.75001 20529741 / 3175418 SX LH</p>

F-M vers.2

	<p>SOTTOPARAURTI CENTRALE P.P. - GRIGIO CENTRAL SPOILER P.P. - GREY</p> <p>COS.PEL. ref. SIMILAR ref. 402.75007 20456804 / 21430599</p>
	<p>ANGOLO SOTTOPARAURTI P.P. - GRIGIO CORNER SPOILER P.P. - GREY</p> <p>COS.PEL. ref. SIMILAR ref. 402.75008 20456806 / 21430672 DX RH</p> <p>402.75009 20456805 / 21430600 SX LH</p>
	<p>PANNELLO ANGOLARE METALLO CORNER PANEL METAL</p> <p>COS.PEL. ref. SIMILAR ref. 1202.65180 20379172 DX RH</p> <p>1202.65181 20379171 SX LH</p>
	<p>FANALINO INGOMBRO CABINA LED 2 LED - 24V - LUCE BIANCA DRIVER'S CAB SIDE MARKER LED 2 LED - 24V</p> <p>COS.PEL. ref. SIMILAR ref. 1602.13811 82116545 DX-SX RH-LH</p>
	<p>MANIGLIA PORTA SENZA CHIAVE DOOR HANDLE WITHOUT KEY</p> <p>COS.PEL. ref. SIMILAR ref. 1702.65600 1062566 / 20398467 / 3175919 DX RH</p> <p>1702.65601 1062565 / 20398466 / 3175918 SX LH</p>
	<p>SERRATURA PORTA ANTERIORE FRONT DOOR LATCH</p> <p>COS.PEL. ref. SIMILAR ref. 1702.65608 20588326 / 21261275 / 21505894 DX RH</p> <p>1702.65607 20588325 / 21261274 / 21505893 SX LH</p>
	<p>ALZACRISTALLI SENZA MOTORINO WINDOW REGULATOR WITHOUT MOTOR</p> <p>COS.PEL. ref. SIMILAR ref. 1902.65200 3176546 / 3981924 DX RH</p> <p>1902.65201 3176545 / 3981923 SX LH</p>
	<p>VASCHETTA ESPANSIONE EXPANSION TANK</p> <p>COS.PEL. ref. SIMILAR ref. 2102.13080 1676400 / 1676576</p>

	<p>VASCHETTA ESPANSIONE EXPANSION TANK</p> <p>COS.PEL. ref. SIMILAR ref. 2102.64080 1674918</p>
	<p>MOLLA A GAS Lunghezza [mm] 685 Corsa [mm] 295 Forza scarto [N] 500 GAS SPRING Lenght [mm] 685 Stroke [mm] 295 Waste force [N] 500</p> <p>COS.PEL. ref. SIMILAR ref. 2402.53100 20379348</p>
	<p>DEFLETTORI LATERALI CON CLIPS SIDEWINDOW DEFLECTORS WITH CLIPS</p> <p>COS.PEL. ref. SIMILAR ref. 3002.00001 -</p>
	<p>FANALE POSTERIORE CON CICALINO REAR-LIGHT WITH BUZZER</p> <p>COS.PEL. ref. SIMILAR ref. 006008 21097450</p> <p>Con cicalino / With buzzer - conn. 003120</p> <p>TRASPARENTE / LENS 010080 20425732 / 20910229 DX RH DX-SX RH-LH</p>
	<p>FANALE POSTERIORE 7 FUNZIONI REAR-LIGHT 7 FUNCTIONS</p> <p>COS.PEL. ref. SIMILAR ref. 006012 20507624 / 20892384 / 21097448</p> <p>Relativo connettore 003120 006011 20507623 / 20892386 / 21097449</p> <p>Con luce targa / With plate light - conn. 003120</p> <p>TRASPARENTE / LENS 010080 20425732 / 20910229 DX RH SX LH DX-SX RH-LH</p>

F-M 4



	<p>TAPPO FRONTALE FRONT PANEL COVER</p> <p>COS.PEL. ref. SIMILAR ref. 102.14120 84151824</p> <p>102.14121 84151777</p> <p style="text-align: right;">DX RH</p> <p style="text-align: right;">SX LH</p>
	<p>GRIGLIA INFERIORE LOWER GRILLE</p> <p>COS.PEL. ref. SIMILAR ref. 102.66100 84162402</p>
	<p>PANNELLO A.B.S. PANEL A.B.S.</p> <p>COS.PEL. ref. SIMILAR ref. 102.66101 82431911 / 84162403</p>
	<p>GRIGLIA ANTERIORE A.B.S. FRONT GRILLE A.B.S.</p> <p>COS.PEL. ref. SIMILAR ref. 102.66102 84086799 / 84577628</p>
	<p>PANNELLO ANGOLARE P.P. PANEL CORNER COVER P.P.</p> <p>COS.PEL. ref. SIMILAR ref. 102.66104 82430057</p> <p>102.66103 82430056</p> <p style="text-align: right;">DX RH</p> <p style="text-align: right;">SX LH</p>

	<p>PANNELLO ANGOLARE PANEL CORNER COVER</p> <p>COS.PEL. ref. SIMILAR ref. 102.66106 82448104 DX RH</p> <p>102.66105 82448110 SX LH</p>
	<p>GRIGLIA ESTERNA PLASTICA P.P. GRILLE STRIPE LOW (OUTER) P.P.</p> <p>COS.PEL. ref. SIMILAR ref. 102.66107 82419490</p>
	<p>GRIGLIA INTERNA METALLO INNER GRILLE METAL</p> <p>COS.PEL. ref. SIMILAR ref. 102.66108 82419488</p>
	<p>PANNELLO SUPERIORE P.P. UPPER PANEL P.P.</p> <p>COS.PEL. ref. SIMILAR ref. 102.66109 82454672</p>
	<p>PANNELLO INFERIORE P.P. LOWER PANEL P.P.</p> <p>COS.PEL. ref. SIMILAR ref. 102.66110 82455156</p>
	<p>PANNELLO A.B.S. PANEL COVER A.B.S.</p> <p>COS.PEL. ref. SIMILAR ref. 102.66112 82454671 DX RH</p> <p>102.66111 82444204 SX LH</p>
	<p>PANNELLO A.B.S. PANEL COVER A.B.S.</p> <p>COS.PEL. ref. SIMILAR ref. 102.66114 82410206 DX RH</p> <p>102.66113 82409793 SX LH</p>
	<p>PARAFANGO ANTERIORE (PARTE POSTERIORE) MO- P.P. FRONT MUDGUARD (REAR PART) P.P.</p> <p>COS.PEL. ref. SIMILAR ref. 202.14207 82637695 / 84007259 DX-SX RH-LH</p>

F-M 4

	<p>PARAFANGO ANTERIORE PARTE POSTERIORE P.P. - TRATTORE MUDGUARD P.P.</p> <p>COS.PEL. ref. SIMILAR ref. 202.14210 82637711</p> <p>202.14211 82637710</p> <p style="text-align: right;">DX RH SX LH</p>
	<p>CALOTTA PARAF. RIBASSATA CON 4 TIRANTI P.P. - NERO - 2010 REAR MUDGUARD FLAT WITH 4 M. TENSIONERS P.P. - BLACK - 2010</p> <p>COS.PEL. ref. SIMILAR ref. 201.30545 21094389 / 21094457</p> <p style="text-align: right;">DX-SX RH-LH</p> <p style="text-align: center;">(201.30547 versione senza i tiranti)</p>
	<p>CALOTTA PARAFANGO RIBASSATA P.P. - NERO - 2010 REAR MUDGUARD FLAT P.P. - BLACK - TYPE 2010</p> <p>COS.PEL. ref. SIMILAR ref. 201.30547 21094389</p> <p style="text-align: right;">DX-SX RH-LH</p> <p style="text-align: center;">Tirante : 1002.13005 - (201.30545 versione con i tiranti)</p>
	<p>MEZZO PARAFANGO POSTERIORE P.P. - NERO - PARTE ANTERIORE - 2010 REAR MUDGUARD P.P. - BLACK - FRONT PART - TYPE 2010</p> <p>COS.PEL. ref. SIMILAR ref. 201.30550 21094392</p> <p style="text-align: right;">DX RH</p> <p>201.30549 21094393</p> <p style="text-align: right;">SX LH</p>
	<p>CALOTTA PARAFANGO POSTERIORE CON 4 TIRANTI P.P. - NERO REAR MUDGUARD WITH 4 MUDGUARD TENSIONERS P.P. - BLACK</p> <p>COS.PEL. ref. SIMILAR ref. 202.13199 21094387 / 21094457</p> <p style="text-align: right;">DX-SX RH-LH</p> <p style="text-align: center;">(202.13200 versione senza i tiranti)</p>
	<p>CALOTTA PARAFANGO POSTERIORE P.P. - NERO REAR MUDGUARD P.P. - BLACK</p> <p>COS.PEL. ref. SIMILAR ref. 202.13200 21094387</p> <p style="text-align: right;">DX-SX RH-LH</p> <p style="text-align: center;">Relativo tirante 1002.13005 - (202.13199 versione con i tiranti)</p>
	<p>MEZZO PARAFANGO POSTERIORE (PARTE POSTERIORE) P.P. - NERO REAR MUDGUARD (REAR PART) P.P. - BLACK</p> <p>COS.PEL. ref. SIMILAR ref. 202.13201 21094394</p> <p style="text-align: right;">DX-SX RH-LH</p>
	<p>MEZZO PARAFANGO POSTERIORE PARTE ANT. P.P. - NERO REAR MUDGUARD FRONT PART P.P. - BLACK</p> <p>COS.PEL. ref. SIMILAR ref. 202.13202 21094391 / 21094397</p> <p style="text-align: right;">DX-SX RH-LH</p>

	<p>CALOTTA PARAFANGO POSTERIORE RIBASSATA P.P. - NERO REAR MUDGUARD P.P. - BLACK</p> <p>COS.PEL. ref. SIMILAR ref. 202.13203 21094384 / 21094388 DX-SX RH-LH</p> <p>Relativo tirante 1002.13005 - (202.13204 versione con i tiranti)</p>
	<p>CALOTTA PARAFANGO POSTERIORE CON 4 TIRANTI P.P. - NERO REAR MUDGUARD WITH 4 MUDGUARD TENSIONERS P.P. - BLACK</p> <p>COS.PEL. ref. SIMILAR ref. 202.13204 21094388 / 21094457 DX-SX RH-LH</p> <p>(202.13203 versione senza i tiranti)</p>
	<p>PEDANA P.P. FOOTSTEP P.P.</p> <p>COS.PEL. ref. SIMILAR ref. 302.66100 21520119 DX RH</p> <p>302.66101 21520015 SX LH</p>
	<p>PARAURTI CENTRALE A.B.S. - GRIGIO CENTRAL BUMPER A.B.S. - GREY</p> <p>COS.PEL. ref. SIMILAR ref. 402.14084 21316576 / 22249883</p>
	<p>ANGOLO PARAURTI A.B.S. - GRIGIO CORNER BUMPER A.B.S. - GREY</p> <p>COS.PEL. ref. SIMILAR ref. 402.14086 21316577 DX RH</p> <p>402.14085 21316575 SX LH</p>
	<p>PARAURTI CENTRALE A.B.S. - LISCIO NERO CENTRAL BUMPER A.B.S. - BLACK</p> <p>COS.PEL. ref. SIMILAR ref. 402.14090 21413787</p>
	<p>ANGOLO PARAURTI A.B.S. - LISCIO NERO CORNER BUMPER A.B.S. - BLACK</p> <p>COS.PEL. ref. SIMILAR ref. 402.14092 21413786 DX RH</p> <p>402.14091 21413789 SX LH</p>
	<p>CERNIERA HINGE</p> <p>COS.PEL. ref. SIMILAR ref. 1002.66000 84104144 DX RH</p> <p>1002.66001 84104142 SX LH</p>

F-M 4

	<p>CORNICE FARO A.B.S. HEADLAMP FRAME A.B.S. COS.PEL. ref. SIMILAR ref. 1102.66600 21963141 DX RH</p> <p>1102.66601 21963005 SX LH</p>
	<p>SUPPORTO FARO A.B.S. HEADLAMP BRACKET A.B.S. COS.PEL. ref. SIMILAR ref. 1102.66602 84027783 DX RH</p> <p>1102.66603 84028392 SX LH</p>
 	<p>FANALINO LATERALE LED SIDE LAMP LED COS.PEL. ref. SIMILAR ref. 1602.14810 82151205 DX RH</p> <p>1602.14809 82151157 SX LH</p>
 	<p>PROIETTORE SENZA CENTRALINA H7 H1 PY21 LED - CORRETTORE ASSETTO MANUALE HEADLAMP W/O CONTROL UNIT H7 H1 PY21 LED - MANUAL LOAD LEVEL ADJUSTEMENT COS.PEL. ref. SIMILAR ref. 1602.14800 21221129 / 22239217 DX RH</p> <p>1602.14801 21221130 / 22239219 SX LH</p>
 	<p>PROIETTORE SENZA CENTRALINA LED - CON MOTORINO - H7,H1,PY21W HEADLAMP W/O CONTROL UNIT LED - WITH MOTOR - H7,H1,PY21W COS.PEL. ref. SIMILAR ref. 1602.14808 21221133 / 22239220 DX RH</p> <p>1602.14807 21221134 / 22239221 SX LH</p>
	<p>TIRANTE CALOTTA GOMMA - NERO MUDGUARD TENSIONER RUBBER - BLACK COS.PEL. ref. SIMILAR ref. 1002.13005 21094457</p>
	<p>KIT PER CONNESSIONI ELETTRICHE Connettore AMP 1,5 singolo KIT FOR ELECTRICAL JOINTS Connector AMP 1,5 simple COS.PEL. ref. SIMILAR ref. 003120 -</p>
	<p>FANALE POSTERIORE REAR-LIGHT LED - 24V - CONNETTORE LATERALE AMP 1.5 LED - 24V - LATERAL CONNECTOR AMP 1.5 COS.PEL. ref. SIMILAR ref. 1502.14000 82849923 / 84195521 / 84441768 DX RH Relativo connettore 003120 1502.14001 82849894 / 84195505 / 84441766 SX LH Con luce targa / With plate light - Relativo connettore 003120 TRASPARENTE / LENS 1502.14100 82849905 DX-SX RH-LH</p>

 <p>cm 16</p>	<p>FANALE POSTERIORE REAR-LIGHT LED - 24V - CONNETTORE LATERALE AMP 1.5 LED - 24V - LATERAL CONNECTOR AMP 1.5</p> <p>COS.PEL. ref. 1502.14002 SIMILAR ref. 82849925 / 84195519 / 84441767 DX RH Con cicalino / With buzzer - Relativo connettore 003120</p> <p>TRASPARENTE / LENS 1502.14100 82849905 DX-SX RH-LH</p>
 <p>cm 16</p>	<p>FANALE POSTERIORE REAR-LIGHT LED - 24V - CONNETTORE LATERALE AMP 1.5 LED - 24V - LATERAL CONNECTOR AMP 1.5</p> <p>COS.PEL. ref. 1502.14004 SIMILAR ref. 21735299 / 84441937 DX RH Relativo connettore 003120 1502.14003 21735301 / 84441936 SX LH Relativo connettore 003120</p> <p>TRASPARENTE / LENS 1502.14101 84122332 DX-SX RH-LH</p>
 <p>cm 16</p>	<p>FANALE POSTERIORE REAR-LIGHT LED - 24V - CONNETTORE LATERALE AMP 1.5 LED - 24V - LATERAL CONNECTOR AMP 1.5</p> <p>COS.PEL. ref. 1502.14006 SIMILAR ref. 82483073 / 84441760 DX RH Con cicalino / With buzzer - Relativo connettore 003120 1502.14005 82483074 / 84441759 SX LH Con luce targa / With plate light - Relativo connettore 003120</p> <p>TRASPARENTE / LENS 1502.14101 84122332 DX-SX RH-LH</p>



<p>AD ESAURIMENTO SCORTE UNTIL SELL OUT</p> 	<p>PARAURTI ANTERIORE 1a serie METALLO FRONT BUMPER 1st series METAL</p> <p>COS.PEL. ref. SIMILAR ref. 402.73830 1573830</p>
<p>AD ESAURIMENTO SCORTE UNTIL SELL OUT</p> 	<p>GRIGLIA PEDANA SUPERIORE METALLO UPPER FOOTSTEP GRILLE METAL</p> <p>COS.PEL. ref. SIMILAR ref. 1002.09844 1509844</p> <p style="text-align: right;">DX-SX RH-LH</p>
<p>AD ESAURIMENTO SCORTE UNTIL SELL OUT</p> 	<p>GRADINO INFERIORE METALLO LOWER FOOTSTEP GRILLE METAL</p> <p>COS.PEL. ref. SIMILAR ref. 1002.09846 1509846</p> <p style="text-align: right;">DX-SX RH-LH</p>



<p>AD ESAURIMENTO SCORTE IN THE SELL-OUT</p> 	<p>GRIGLIA INFERIORE A.B.S. - BIANCO LOWER GRILLE A.B.S. - WHITE</p> <p>COS.PEL. ref. SIMILAR ref. 102.12163 1621181</p>
<p>AD ESAURIMENTO SCORTE IN THE SELL-OUT</p> 	<p>PARAFANGO ANTERIORE R.T.M. - BIANCO FRONT MUDGUARD R.T.M. - WHITE</p> <p>COS.PEL. ref. SIMILAR ref. 202.16121 1623888</p> <p style="text-align: right;">DX-SX RH-LH</p>
	<p>PARAURTI ANTERIORE METALLO FRONT BUMPER METAL</p> <p>COS.PEL. ref. SIMILAR ref. 402.58216 8158216</p>
	<p>VETRO SPECCHIO RISCALDATO - (430x191mm) MIRROR GLASS HEATED - (430x191mm)</p> <p>COS.PEL. ref. SIMILAR ref. 502.33333 1697007</p> <p style="text-align: right;">DX-SX RH-LH</p>
	<p>VETRO SPECCHIO RISCALDATO - (376x190mm) MIRROR GLASS HEATED - (376x190mm)</p> <p>COS.PEL. ref. SIMILAR ref. 502.44444 1699014</p> <p style="text-align: right;">DX-SX RH-LH</p>



F 10-12-16

COS.VO

	<p>SPECCHIO RETROVISORE RISCALDATO REAR-VIEW MIRROR HEATED</p> <p>COS.PEL. ref. 502.99011 SIMILAR ref. 1699011</p> <p style="text-align: right;">DX-SX RH-LH</p>
	<p>SPECCHIO RETROVISORE GRANDANGOLO - RISCALDATO REAR-VIEW MIRROR WIDE ANGLE - HEATED</p> <p>COS.PEL. ref. 502.99013 SIMILAR ref. 1699013</p> <p style="text-align: right;">DX RH</p>
	<p>VETRO SPECCHIO GRANDANGOLO - RISCALDATO - (194x158mm) MIRROR GLASS WIDE ANGLE - HEATED - (194x158mm)</p> <p>COS.PEL. ref. 502.99017 SIMILAR ref. 1699017</p> <p style="text-align: right;">DX RH</p>
	<p>VISIERA PARASOLE METACRILATO TRASPARENTE - GRIGIO SUN VISOR TRANSPARENT METACRYLIC - GREY</p> <p>COS.PEL. ref. 702.00012 SIMILAR ref. 1584316</p> <p style="text-align: right;">Relativo kit staffe 1002.01216</p>
	<p>CONVOGLIATORE ARIA R.T.M. - BIANCO AIR CONVEYOR R.T.M. - WHITE</p> <p>COS.PEL. ref. 902.98144 SIMILAR ref. 1698145</p> <p style="text-align: right;">DX RH</p> <p>902.98145 1698144 SX LH</p>
<p>AD ESAURIMENTO SCORTE UNTIL SELL OUT</p> 	<p>CERNIERA METALLO HINGE METAL</p> <p>COS.PEL. ref. 1002.21148 SIMILAR ref. 1621449</p> <p style="text-align: right;">DX RH</p> <p>1002.21149 1621448 SX LH</p>
	<p>CERNIERA METALLO HINGE METAL</p> <p>COS.PEL. ref. 1002.21450 SIMILAR ref. 1621451</p> <p style="text-align: right;">DX RH</p> <p>1002.21451 1621450 SX LH</p>
<p>AD ESAURIMENTO SCORTE UNTIL SELL OUT</p> 	<p>STAFFA FARO METALLO HEADLAMP BRACKET METAL</p> <p>COS.PEL. ref. 1002.21906 SIMILAR ref. 1621907</p> <p style="text-align: right;">DX RH</p> <p>1002.21905 1621905 SX LH</p>

	<p>SUPPORTO PEDANA METALLO FOOTSTEP BRACKET METAL</p> <p>COS.PEL. ref. SIMILAR ref. 1002.51346 8151345</p> <p style="text-align: right;">DX RH</p>
<p>AD ESAURIMENTO SCORTE UNTIL SELL-OUT</p> 	<p>STAFFA PER GRIGLIA SUPERIORE METALLO UPPER GRILLE BRACKET METAL</p> <p>COS.PEL. ref. SIMILAR ref. 1002.80061 1080061</p>
<p>AD ESAURIMENTO SCORTE UNTIL SELL-OUT</p> 	<p>STAFFA FARO METALLO HEADLAMP BRACKET METAL</p> <p>COS.PEL. ref. SIMILAR ref. 1002.89123 1089122</p> <p style="text-align: right;">SX LH</p>
	<p>CORNICE SOTTOFARO A.B.S. - BIANCO UNDER HEADLAMP FRAME A.B.S. - WHITE</p> <p>COS.PEL. ref. SIMILAR ref. 1102.21182 1621183</p> <p style="text-align: right;">DX RH</p> <p>1102.21183 1621182 SX LH</p>
	<p>CORNICE FARO A.B.S. - BIANCO HEADLAMP FRAME A.B.S. - WHITE</p> <p>COS.PEL. ref. SIMILAR ref. 1102.88870 1088871</p> <p style="text-align: right;">DX RH</p> <p>1102.88871 1088870 SX LH</p>
	<p>CORNICE FANALINO A.B.S. LAMP FRAME A.B.S.</p> <p>COS.PEL. ref. SIMILAR ref. 1102.98146 1698147</p> <p style="text-align: right;">DX RH</p> <p>1102.98147 1698146 SX LH</p>
	<p>FIANCHETTO LATERALE A.B.S. - NERO CORNER PANEL A.B.S. - BLACK</p> <p>COS.PEL. ref. SIMILAR ref. 1202.10782 1610783</p> <p style="text-align: right;">DX RH</p> <p>1202.10783 1610782 SX LH</p>
 	<p>FANALINO CORNER LAMP</p> <p>COS.PEL. ref. SIMILAR ref. 1602.93924 1593924</p> <p style="text-align: right;">DX RH</p> <p>1602.93923 1593923 SX LH</p>

F 10-12-16

 	<p>PROIETTORE H4 - CORRETTORE ASSETTO MANUALE HEADLAMP H4 - MANUAL LOAD LEVEL ADJUSTEMENT</p> <p>COS.PEL. ref. SIMILAR ref. 1602.93922 3175032</p> <p style="text-align: right;">DX-SX RH-LH</p>
	<p>FANALE POSTERIORE REAR-LIGHT</p> <p>COS.PEL. ref. SIMILAR ref. 005880 8191748</p> <p>005890 8191747 Con luce targa / With plate light</p> <p>TRASPARENTE / LENS 011111 8142919</p> <p style="text-align: right;">DX RH SX LH DX-SX RH-LH</p>



	<p>GRIGLIA SUPERIORE A.B.S. - NERO UPPER GRILLE A.B.S. - BLACK</p> <p>COS.PEL. ref. SIMILAR ref. 102.44455 20360507 / 8144455</p>
	<p>GRIGLIA INFERIORE A.B.S. - NERO LOWER GRILLE A.B.S. - BLACK</p> <p>COS.PEL. ref. SIMILAR ref. 102.44482 1063509 / 8144482</p>
	<p>CALANDRA ANTERIORE SUPERIORE METALLO UPPER FRONT PANEL METAL</p> <p>COS.PEL. ref. SIMILAR ref. 102.91220 8191220</p>
	<p>PARAFANGO ANTERIORE RUOTA ANTERIORE A.B.S. - NERO REAR MUDGUARD FRONT WHEEL A.B.S. - BLACK</p> <p>COS.PEL. ref. SIMILAR ref. 202.23459 1623459</p> <p style="text-align: right;">DX-SX RH-LH</p>
	<p>PROLUNGA PARAFANGO LATERALE A.B.S. - GRIGIO EXTENSION MUDGUARD A.B.S. - GREY</p> <p>COS.PEL. ref. SIMILAR ref. 202.41236 8122894 / 8141237</p> <p style="text-align: right;">DX RH</p> <p>202.41237 8122893 / 8141236</p> <p style="text-align: right;">SX LH</p>

	<p>PARAFANGO ANTERIORE RUOTA ANTERIORE A.B.S. - NERO FRONT MUDGUARD FRONT WHEEL A.B.S. - BLACK COS.PEL. ref. SIMILAR ref. 202.44552 8144552</p> <p>202.44551 8144551</p> <p style="text-align: right;">DX RH SX LH</p>
	<p>PEDANA PARAFANGO A.B.S. - GRIGIO MUDGUARD FOOTSTEP A.B.S. - GREY COS.PEL. ref. SIMILAR ref. 202.75246 3175247 / 3981764 / 8144108 / 8189196 / 8189301</p> <p>202.75247 Griglia/Grille : 1002.91314 inf - 1002.91315 sup 3175246 / 3981762 / 8144107 / 8189195 / 8189300 Griglia/Grille : 1002.91314 inf - 1002.91315 sup</p> <p style="text-align: right;">DX RH SX LH</p>
	<p>COPERCHIO PARAFANGO POSTERIORE A.B.S. - NERO COVER REAR MUDGUARD A.B.S. - BLACK COS.PEL. ref. SIMILAR ref. 202.92547 20721840</p>
	<p>CALOTTA PARAFANGO POSTERIORE CON 8 TIRANTI 1a serie - P.P. - NERO REAR MUDGUARD WITH 8 MUDGUARD TENSIONERS 1st series - P.P. - BLACK COS.PEL. ref. SIMILAR ref. 202.55807 8155808 / 8156556</p> <p style="text-align: right;">DX-SX RH-LH</p> <p>(202.55808 versione senza i tiranti)</p>
	<p>CALOTTA PARAFANGO POSTERIORE 1a serie - P.P. - NERO REAR MUDGUARD 1st series - P.P. - BLACK COS.PEL. ref. SIMILAR ref. 202.55808 8155808</p> <p style="text-align: right;">DX-SX RH-LH</p> <p>Relativo tirante 1002.56556 - (202.55807 versione con i tiranti)</p>
	<p>MEZZO PARAFANGO POSTERIORE 1a serie - P.P. - NERO REAR MUDGUARD 1st series - P.P. - BLACK COS.PEL. ref. SIMILAR ref. 202.56551 8156551</p> <p style="text-align: right;">DX-SX RH-LH</p>
	<p>MEZZO PARAFANGO POSTERIORE 1a serie - A.B.S. - NERO REAR MUDGUARD 1st series - A.B.S. - BLACK COS.PEL. ref. SIMILAR ref. 202.56552 8156552</p> <p style="text-align: right;">DX-SX RH-LH</p>
	<p>CALOTTA PARAFANGO POSTERIORE CON 4 TIRANTI P.P. - GRIGIO - RIBASSATA REAR MUDGUARD FLAT TYPE W. 4 MUDG.TENSION. P.P. - GREY COS.PEL. ref. SIMILAR ref. 202.71389 1079965 / 1079981 / 20722652 / 20936759 / 3171391</p> <p style="text-align: right;">DX-SX RH-LH</p> <p>(202.71390 versione senza i tiranti)</p>

	<p>CALOTTA PARAFANGO POSTERIORE P.P. - GRIGIO - RIBASSATA REAR MUDGUARD P.P. - GREY</p> <p>COS.PEL. ref. SIMILAR ref. 202.71390 1079965 / 20722652 / 20936759 / 3171391 DX-SX RH-LH</p> <p>Relativo tirante 1002.56557 - (202.71389 versione con i tiranti)</p>
	<p>MEZZO PARAFANGO POSTERIORE P.P. - GRIGIO REAR MUDGUARD P.P. - GREY</p> <p>COS.PEL. ref. SIMILAR ref. 202.92544 20392544 DX-SX RH-LH</p> <p>Legato a 1002.56559 2pz + 1002.56564 2pz</p>
	<p>VASCHETTA PEDANA (GUIDA A DESTRA) A.B.S. - GRIGIO FOOTSTEP (RHD) A.B.S. - GREY</p> <p>COS.PEL. ref. SIMILAR ref. 302.41005 8141312 SX LH</p> <p>Griglia/Grille 1002.91313</p>
	<p>VASCHETTA PEDANA A.B.S. - GRIGIO FOOTSTEP A.B.S. - GREY</p> <p>COS.PEL. ref. SIMILAR ref. 302.41004 8141004 / 8141313 DX RH</p> <p>302.41003 Griglia/Grille 1002.91313 8141003 SX LH</p> <p>Griglia/Grille 1002.91313</p>
	<p>PARAURTI ANTERIORE METALLO FRONT BUMPER METAL</p> <p>COS.PEL. ref. SIMILAR ref. 402.89329 8144454 / 8189329</p>
	<p>SOTTOPARAURTI A.B.S. - NERO SPOILER A.B.S. - BLACK</p> <p>COS.PEL. ref. SIMILAR ref. 402.88888 3981256 / 8152722 / 8189337</p>
	<p>PEDANA PARAURTI METALLO FRONT BUMPER FOOTSTEP METAL</p> <p>COS.PEL. ref. SIMILAR ref. 402.89328 1626680 / 20372227 DX RH</p> <p>402.89327 1626679 / 20372226 SX LH</p>
	<p>COPPA SPECCHIO CON G.A. BASSO SPARE HEAD</p> <p>COS.PEL. ref. SIMILAR ref. 502.00000 3091259 DX RH</p> <p>502.00001 (DX con g.a basso) 3091256 SX LH</p>

	<p>VETRO SPECCHIO RISCALDATO - (433x198mm) MIRROR GLASS HEATED - (433x198mm)</p> <p>COS.PEL. ref. 502.91756 SIMILAR ref. 3092854</p> <p style="text-align: right;">DX-SX RH-LH</p>
	<p>VETRO SPECCHIO RAGGIO 300 - GRANDANGOLO - RISCALDATO - (181X175mm) MIRROR GLASS RADIUS 300 - WIDE ANGLE - HEATED - (181X175mm)</p> <p>COS.PEL. ref. 502.91757 SIMILAR ref. 20854568 / 21203311 / 3091757</p> <p style="text-align: right;">DX-SX RH-LH</p>
	<p>VISIERA PARASOLE METACRILATO TRASPARENTE - GRIGIO SUN VISOR TRANSPARENT METACRYLIC - GREY</p> <p>COS.PEL. ref. 702.01212 SIMILAR ref. 8189318</p>
	<p>VISIERA PARASOLE CON FORI METACRILATO TRASPARENTE - GRIGIO SUN VISOR WITH HOLES TRANSPARENT METACRYLIC - GREY</p> <p>COS.PEL. ref. 702.01216 SIMILAR ref. 8189310</p>
<p>AD ESAURIMENTO SCORTE UNTIL SELL OUT</p> 	<p>CARENATURA F-H-16 SENZA STAFFE (PASSO 3700mm) - STRATIFICAZIONE MANUALE - BIANCO FAIRING F-H-16 WITHOUT BRACKETS (WHEEL BASE 3700mm) - G.R.P. - WHITE</p> <p>COS.PEL. ref. 802.99018 SIMILAR ref. -</p> <p style="text-align: right;">DX RH</p> <p>802.99017 - Relativo kit staffe 1002.99014</p> <p style="text-align: right;">SX LH</p> <p style="text-align: right;">- Relativo kit staffe 1002.99013</p>
<p>AD ESAURIMENTO SCORTE UNTIL SELL OUT</p> 	<p>CONVOGLIATORE ARIA A.B.S. - NERO AIR CONVEYOR A.B.S. - BLACK</p> <p>COS.PEL. ref. 902.99000 SIMILAR ref. -</p> <p style="text-align: right;">DX RH</p> <p>902.99001 -</p> <p style="text-align: right;">SX LH</p>
	<p>ANCORAGGIO GRIGLIA SUPERIORE A.B.S. - NERO UPPER GRILLE ANCHORAGE A.B.S. - BLACK</p> <p>COS.PEL. ref. 1002.40333 SIMILAR ref. 8140333</p>
	<p>SUPPORTO PARAFANGO POSTERIORE ALLUMINIO REAR MUDGUARD BRACKET ALUMINIUM</p> <p>COS.PEL. ref. 1002.77451 SIMILAR ref. 1077451</p>

	<p>COPRI BATTERIE P.P.G.F. - NERO BATTERY COVER P.P.G.F. - BLACK</p> <p>COS.PEL. ref. SIMILAR ref. 1002.91005 20507252 / 3127594</p>
	<p>GRIGLIA PEDANA INFERIORE METALLO LOWER FOOTSTEP GRILLE METAL</p> <p>COS.PEL. ref. SIMILAR ref. 1002.91313 20379437 / 8191313 DX-SX RH-LH</p>
	<p>GRIGLIA PEDANA CENTRALE METALLO CENTRAL FOOTSTEP GRILLE METAL</p> <p>COS.PEL. ref. SIMILAR ref. 1002.91314 20379438 / 8191314 DX-SX RH-LH</p>
	<p>GRIGLIA PEDANA SUPERIORE METALLO UPPER FOOTSTEP GRILLE METAL</p> <p>COS.PEL. ref. SIMILAR ref. 1002.91315 20379439 / 8191315 DX-SX RH-LH</p>
	<p>SUPPORTO PORTAFARO METALLO HEADLAMP BRACKET STEEL</p> <p>COS.PEL. ref. SIMILAR ref. 1002.91402 8191402 DX RH</p> <p>1002.91401 8191401 SX LH</p>
<p>AD ESAURIMENTO SCORTE UNTIL SELL-OUT</p> 	<p>KIT STAFFE CARENATURE PER 802.99013/4/7/8 BRACKETS KIT FAIRING FOR 802.99013/4/7/8</p> <p>COS.PEL. ref. SIMILAR ref. 1002.99014 - DX RH</p> <p>1002.99013 - Per 802.99014/8 - For 802.99014/8 SX LH</p> <p>Per 802.99013/7 - For 802.99013/7</p>
	<p>RIPARO CORNICE FARO A.B.S. - NERO PROTECTING PLATE FOR HEADLIGHT BEZEL A.B.S. - BLACK</p> <p>COS.PEL. ref. SIMILAR ref. 1102.41290 8141290 DX RH</p> <p>1102.41289 8141289 SX LH</p>
	<p>CORNICE FARO A.B.S. - NERO HEADLAMP FRAME A.B.S. - BLACK</p> <p>COS.PEL. ref. SIMILAR ref. 1102.62548 1062548 / 20398386 / 3090971 DX RH / 3980870</p> <p>1102.62547 1062547 / 20398385 / 3090972 SX LH / 3980869</p>

F-H

COS.VO

	<p>FIANCHETTO LATERALE METALLO CORNER PANEL METAL</p> <p>COS.PEL. ref. SIMILAR ref. 1202.89092 1619149 / 8189093 DX RH</p> <p>1202.89093 1619148 / 8189092 SX LH</p>
	<p>PROLUNGA PORTA A.B.S. - NERO EXTENSION DOOR A.B.S. - BLACK</p> <p>COS.PEL. ref. SIMILAR ref. 1402.86534 1086534 / 1619691 / 20398908 DX RH</p> <p>1402.86533 1086533 / 1619690 / 20398907 SX LH</p>
 	<p>FANALINO LATERALE R5W - 3 PIN SIDE LAMP R5W - 3 PIN</p> <p>COS.PEL. ref. SIMILAR ref. 1602.81666 3981666 / 8191142 DX-SX RH-LH</p>
 	<p>FANALINO P21W/W5W - BICOLORE - 3 PIN CORNER LAMP P21W/W5W - DOUBLE COLOUR - 3 PIN</p> <p>COS.PEL. ref. SIMILAR ref. 1602.81668 3981668 DX-SX RH-LH</p>
 	<p>FANALINO CON PROFONDITA' H3 R5W LAMP H3 R5W</p> <p>COS.PEL. ref. SIMILAR ref. 1602.60274 20360274 DX RH</p> <p>1602.60273 20360273 SX LH</p>
 	<p>FENDINEBBIA H3 FOG LAMP H3</p> <p>COS.PEL. ref. SIMILAR ref. 1602.81665 1062190 / 22105756 DX-SX RH-LH</p>
 	<p>PROIETTORE H4 - CORRETTORE ASSETTO MANUALE HEADLAMP H4 - MANUAL LOAD LEVEL ADJUSTEMENT</p> <p>COS.PEL. ref. SIMILAR ref. 1602.81669 3981594 DX-SX RH-LH</p>
	<p>MANIGLIA PORTA SENZA CHIAVE DOOR HANDLE WITHOUT KEY</p> <p>COS.PEL. ref. SIMILAR ref. 1702.65600 1062566 / 20398467 / 3175919 DX RH</p> <p>1702.65601 1062565 / 20398466 / 3175918 SX LH</p>

	<p>SERRATURA INTERNA PORTA DOOR INSIDE HANDLE BASE</p> <p>COS.PEL. ref. SIMILAR ref. 1702.65606 1063328 / 8142044</p> <p>1702.65605 1063327 / 8142043</p> <p style="text-align: right;">DX RH</p> <p style="text-align: right;">SX LH</p>
	<p>ALZACRISTALLI SENZA MOTORINO WINDOW REGULATOR WITHOUT MOTOR</p> <p>COS.PEL. ref. SIMILAR ref. 1902.65200 3176546 / 3981924</p> <p>1902.65201 3176545 / 3981923</p> <p style="text-align: right;">DX RH</p> <p style="text-align: right;">SX LH</p>
	<p>ALZACRISTALLI ELETTRICO - CON MOTORINO - 2 FILI WINDOW REGULATOR ELECTRIC - WITH MOTOR - 2 WIRES</p> <p>COS.PEL. ref. SIMILAR ref. 1902.65202 3176542</p> <p>1902.65203 3176541</p> <p style="text-align: right;">DX RH</p> <p style="text-align: right;">SX LH</p>
	<p>VASCHETTA ESPANSIONE EXPANSION TANK</p> <p>COS.PEL. ref. SIMILAR ref. 2102.13080 1676400 / 1676576</p>
	<p>VASCHETTA ESPANSIONE EXPANSION TANK</p> <p>COS.PEL. ref. SIMILAR ref. 2102.64080 1674918</p>
	<p>TIRANTE PARAFANGO GOMMA - NERO MUDGUARD TENSIONER RUBBER - BLACK</p> <p>COS.PEL. ref. SIMILAR ref. 1002.56556 8156556</p>
	<p>TIRANTE PARAFANGO GOMMA - NERO MUDGUARD TENSIONER RUBBER - BLACK</p> <p>COS.PEL. ref. SIMILAR ref. 1002.56557 1079981</p>
	<p>DEFLETTORI LATERALI CON CLIPS SIDOWINDOW DEFLECTORS WITH CLIPS</p> <p>COS.PEL. ref. SIMILAR ref. 3002.00001 -</p>

F-H



**FANALE POSTERIORE
REAR-LIGHT**

7 FUNZIONI
7 FUNCTIONS

COS.PEL. ref.
006000

SIMILAR ref.
3981456

DX RH

006010

Relativo connettore 003120

SX LH

TRASPARENTE / LENS

3981455

Con luce targa / With plate light - conn. 003120

011211

3981782

DX-SX RH-LH



	<p>GRIGLIA INFERIORE A.B.S. - BIANCO LOWER GRILLE A.B.S. - WHITE</p> <p>COS.PEL. ref. SIMILAR ref. 102.53716 20453716 / 20516776 / 21358670</p>
	<p>TELAIO GRIGLIA INFERIORE METALLO UPPER AND LOWER INNER GRILLE STEEL</p> <p>COS.PEL. ref. SIMILAR ref. 102.53717 20456963 / 20533138</p>
	<p>GRIGLIA INFERIORE / SUPERIORE ESTERNA A.B.S. - NERO UPPER AND LOWER GRILLE EXTERNAL A.B.S. - BLACK</p> <p>COS.PEL. ref. SIMILAR ref. 102.53718 20409818 / 20529704</p>
	<p>ANGOLARE INFERIORE PARABREZZA A.B.S. - NERO CORNER PANEL A.B.S. - BLACK</p> <p>COS.PEL. ref. SIMILAR ref. 102.53720 20379358 / 20529672 DX RH</p> <p>102.53719 20379357 / 20529668 SX LH</p>
	<p>TAPPO GRIGLIA INFERIORE A.B.S. - NERO COVER GRILLE A.B.S. - BLACK</p> <p>COS.PEL. ref. SIMILAR ref. 102.53960 20453690 / 20453960 / 21425186 DX-SX RH-LH</p>

F-H vers.2

	<p>GRIGLIA SUPERIORE S.M.C. - BIANCO UPPER GRILLE S.M.C. - WHITE</p> <p>COS.PEL. ref. SIMILAR ref. 102.60266 20360266</p>
	<p>COPERCHIO ANTERIORE SUPERIORE A.B.S. - NERO UPPER FRONT COVER A.B.S. - BLACK</p> <p>COS.PEL. ref. SIMILAR ref. 102.75546 20529706 / 21023797 / 3175546 DX RH</p> <p>102.75545 20529705 / 21023794 / 3175545 SX LH</p>
	<p>COPERCHIO ANTERIORE INFERIORE A.B.S. - GRIGIO LOWER FRONT COVER A.B.S. - GREY</p> <p>COS.PEL. ref. SIMILAR ref. 102.75548 20529708 / 21023802 / 3175548 DX RH</p> <p>102.75547 20529707 / 3175547 SX LH</p>
	<p>PEDANA PARAFANGO A.B.S. - GRIGIO MUDGUARD FOOTSTEP A.B.S. - GREY</p> <p>COS.PEL. ref. SIMILAR ref. 202.75928 3175928 DX RH</p> <p>202.75927 Griglia/Grille : 1002.60788 inf - 1002.91315 sup 3175927 SX LH</p> <p>Griglia/Grille : 1002.60789 inf - 1002.91315 sup</p>
	<p>PROLUNGA PARAFANGO LATERALE A.B.S. - GRIGIO EXTENSION MUDGUARD A.B.S. - GREY</p> <p>COS.PEL. ref. SIMILAR ref. 202.75930 21302470 / 3175930 DX RH</p> <p>202.75929 3175929 SX LH</p>
	<p>PARAFANGO ANTERIORE RUOTA ANTERIORE A.B.S. - NERO FRONT MUDGUARD FRONT WHEEL A.B.S. - BLACK</p> <p>COS.PEL. ref. SIMILAR ref. 202.75932 20372065 DX RH</p> <p>202.75931 20372064 SX LH</p>
	<p>PARAFANGO LATERALE A.B.S. - GRIGIO MUDGUARD A.B.S. - GREY</p> <p>COS.PEL. ref. SIMILAR ref. 202.75934 20529684 / 3175934 DX RH</p> <p>202.75933 20529682 / 3175933 SX LH</p>
	<p>PARAFANGO POSTERIORE RUOTA ANTERIORE A.B.S. - GRIGIO REAR MUDGUARD FRONT WHEEL A.B.S. - GREY</p> <p>COS.PEL. ref. SIMILAR ref. 202.75935 20453900 DX-SX RH-LH</p>

	<p>PARAFANGO LATERALE A.B.S. - GRIGIO MUDGUARD A.B.S. - GREY COS.PEL. ref. SIMILAR ref. 202.75936 20529686 202.75937 20529685</p> <p style="text-align: right;">DX RH SX LH</p>
	<p>PARASPRUZZI ANTISPRAY COS.PEL. ref. SIMILAR ref. 202.13205 20843850</p>
	<p>PARASPRUZZI ANTISPRAY COS.PEL. ref. SIMILAR ref. 202.13206 -</p>
	<p>COPERTURA INTERNA PARAFANGO INNER MUDGUARD FLAP COS.PEL. ref. SIMILAR ref. 202.13207 1079997</p>
	<p>CALOTTA PARAFANGO POSTERIORE RIBASSATA A.B.S. - NERO REAR MUDGUARD FLAT TYPE A.B.S. - BLACK COS.PEL. ref. SIMILAR ref. 202.71380 20549696 / 20723630 DX-SX RH-LH Relativo tirante 1002.56557 - (202.71381 versione con i tiranti)</p>
	<p>CALOTTA PARAF. POSTER. RIBASSATA CON 4 TIRANTI A.B.S. - NERO REAR MUDGUARD FLAT TYPE WITH 4 M. TENSIONERS A.B.S. - BLACK COS.PEL. ref. SIMILAR ref. 202.71381 1079981 / 20549696 / 20723630 DX-SX RH-LH (202.71380 versione senza i tiranti)</p>
	<p>CALOTTA PARAFANGO POSTERIORE CON 4 TIRANTI P.P. - GRIGIO REAR MUDGUARD WITH 4 MUDGUARD TENSIONERS P.P. - GREY COS.PEL. ref. SIMILAR ref. 202.71387 1079981 / 20936769 DX-SX RH-LH (202.71391 versione senza i tiranti)</p>
	<p>CALOTTA PARAFANGO POSTERIORE CON 4 TIRANTI P.P. - GRIGIO - RIBASSATA REAR MUDGUARD FLAT TYPE W. 4 MUDG.TENSION. P.P. - GREY COS.PEL. ref. SIMILAR ref. 202.71389 1079965 / 1079981 / 20722652 / 20936759 DX-SX RH-LH (202.71390 versione senza i tiranti)</p>

ALL ITEMS MENTIONED IN OUR CATALOGUE ARE NOT ORIGINAL PARTS BUT PERFECTLY INTERCHANGEABLE WITH THEM.
GOVERNING LEGISLATIONS FOR THE SALE OF OUR PRODUCTS DIFFER IN EACH COUNTRY.

INFRINGEMENTS, IF ANY, OF LOCAL LEGISLATIONS ARE RESPONSIBILITY OF THE RETAILER IN THE COUNTRY OF FINAL DISTRIBUTION.



F-H vers.2

	<p>CALOTTA PARAFANGO POSTERIORE P.P. - GRIGIO - RIBASSATA REAR MUDGUARD P.P. - GREY</p> <p>COS.PEL. ref. 202.71390 SIMILAR ref. 1079965 / 20722652 / 20936759 / 3171391 DX-SX RH-LH</p> <p>Relativo tirante 1002.56557 - (202.71389 versione con i tiranti)</p>
	<p>CALOTTA PARAFANGO POSTERIORE P.P. - GRIGIO REAR MUDGUARD P.P. - GREY</p> <p>COS.PEL. ref. 202.71391 SIMILAR ref. 20936769 DX-SX RH-LH</p> <p>Relativi tiranti 1002.56557/8 (7 per COS.VO e 8 per COS.RE)</p>
	<p>MEZZO PARAFANGO POSTERIORE P.P. - GRIGIO REAR MUDGUARD P.P. - GREY</p> <p>COS.PEL. ref. 202.92544 SIMILAR ref. 20392544 DX-SX RH-LH</p> <p>Legato a 1002.56559 2pz + 1002.56564 2pz</p>
	<p>VASCHETTA PEDANA P.P. - GRIGIO FOOTSTEP P.P. - GREY</p> <p>COS.PEL. ref. 302.41008 SIMILAR ref. 20529640 / 3175407 DX RH</p> <p>302.41007 Griglia/Grille 1002.60788 20529638 / 3175406 SX LH</p> <p>Griglia/Grille 1002.60789</p>
	<p>PARAURTI CENTRALE P.P.T. - PRIMER CENTRAL BUMPER P.P.T. - PRIMER</p> <p>COS.PEL. ref. 402.74997 SIMILAR ref. 20425625 / 21359080</p>
	<p>ANGOLO PARAURTI P.P.T. - PRIMER CORNER BUMPER P.P.T. - PRIMER</p> <p>COS.PEL. ref. 402.74998 SIMILAR ref. 20425627 / 21359090 DX RH</p> <p>402.74999 20425626 / 21359082 SX LH</p>
	<p>PARAURTI CENTRALE P.P.T. - NERO CENTRAL BUMPER P.P.T. - BLACK</p> <p>COS.PEL. ref. 402.75000 SIMILAR ref. 20529740 / 3175417</p>
	<p>ANGOLO PARAURTI P.P. - NERO CORNER BUMPER P.P. - BLACK</p> <p>COS.PEL. ref. 402.75002 SIMILAR ref. 20529742 / 3175419 DX RH</p> <p>402.75001 20529741 / 3175418 SX LH</p>

	<p>PARAURTI CENTRALE METALLO - NERO CENTRAL BUMPER METAL - BLACK</p> <p>COS.PEL. ref. SIMILAR ref. 402.75003 20398709 / 20429679 / 20711859 / 21828914</p>
	<p>ANGOLO PARAURTI METALLO - NERO CORNER BUMPER METAL - BLACK</p> <p>COS.PEL. ref. SIMILAR ref. 402.75004 20398708 / 20429681 / 20711861 / 21829052 DX RH</p> <p>402.75005 20398707 / 20429680 / 20711860 / 21829051 SX LH</p>
	<p>BARRA PARAINCASTRO ANTERIORE METALLO - NERO UNDER BUMPER METAL - BLACK</p> <p>COS.PEL. ref. SIMILAR ref. 402.75006 20467448</p>
	<p>RINFORZO PARAURTI ANTERIORE METALLO BUMPER SUPPORT METAL</p> <p>COS.PEL. ref. SIMILAR ref. 402.75010 20456550 / 20467442 / 21484901</p>
	<p>SOTTOPARAURTI CENTRALE P.P. - GRIGIO CENTRAL SPOILER P.P. - GREY</p> <p>COS.PEL. ref. SIMILAR ref. 402.75007 20456804 / 21430599</p>
	<p>ANGOLO SOTTOPARAURTI P.P. - GRIGIO CORNER SPOILER P.P. - GREY</p> <p>COS.PEL. ref. SIMILAR ref. 402.75008 20456806 / 21430672 DX RH</p> <p>402.75009 20456805 / 21430600 SX LH</p>
	<p>TERMINALE PARAURTI FRONT TERMINAL SPOILER</p> <p>COS.PEL. ref. SIMILAR ref. 402.75012 20453677 / 20453679 DX RH</p> <p>402.75011 20433678 / 20453676 SX LH</p>
	<p>SPECCHIO COMPLETO CON BRACCIO TETTO BASSO TETTO BASSO COMPLETE FRONT MIRROR WITH ARM LOW CAB LOW CAB</p> <p>COS.PEL. ref. SIMILAR ref. 502.13604 20900679 / 21151129</p>

	<p>SPECCHIO COMPLETO CON BRACCIO TETTO ALTO TETTO ALTO COMPLETE FRONT MIRROR WITH ARM HIGH CAB HIGH CAB</p> <p>COS.PEL. ref. SIMILAR ref. 502.13605 20900682 / 21151132</p>
	<p>SPECCHIO COMPLETO GUARDAVANTI MIRROR</p> <p>COS.PEL. ref. SIMILAR ref. 502.13606 20716956</p>
	<p>VETRO SPECCHIO RISCALDATO MIRROR GLASS HEATED</p> <p>COS.PEL. ref. SIMILAR ref. 502.55986 20455986 / 20567670 DX-SX RH-LH</p>
	<p>VETRO SPECCHIO GRANDANGOLO - RISCALDATO - RAGGIO 300 MIRROR GLASS WIDE ANGLE - HEATED - RADIUS 300</p> <p>COS.PEL. ref. SIMILAR ref. 502.55995 20455995 / 20567685 DX-SX RH-LH</p>
	<p>SPECCHIO RETROVISORE GRANDANGOLO - RISCALDATO - RAGGIO 300 REAR-VIEW MIRROR WIDE ANGLE - HEATED - RADIUS 300</p> <p>COS.PEL. ref. SIMILAR ref. 502.62798 20360806 DX RH</p> <p>502.62799 20360807 / 20360811 / 20455995 SX LH</p>
	<p>COPERCHIO RETROVISORE GRANDANGOLO - A.B.S. - NERO MIRROR COVER WIDE ANGLE - A.B.S. - BLACK</p> <p>COS.PEL. ref. SIMILAR ref. 502.62800 20360811 DX-SX RH-LH</p>
	<p>COPERCHIO RETROVISORE A.B.S. - NERO COVER MIRROR A.B.S. - BLACK</p> <p>COS.PEL. ref. SIMILAR ref. 502.62801 20360810 / 20746401 DX-SX RH-LH</p>
<p>AD ESAURIMENTO SCORTE UNTIL SELL OUT</p> 	<p>COPPA ELETTRICO - RISCALDATO SPARE HEAD ELECTRIC - HEATED</p> <p>COS.PEL. ref. SIMILAR ref. 502.62802 20455982 / 20567647 / 20936170 DX RH</p> <p>502.62803 20455981 / 20455984 / 20567637 / 20936169 SX LH</p>

	<p>SPECCHIO RETROVISORE ELETTRICO - RISCALDATO - BRACCIO CORTO REAR-VIEW MIRROR ELECTRIC - HEATED - SHORT ARM COS.PEL. ref. SIMILAR ref. 502.62804 - DX RH</p> <p>502.62805 - SX LH</p>
	<p>SUPPORTO VISIERA PARASOLE CABINA MEDIA/ALTA PARTE INFERIORE SUN VISOR BRACKET LOWER PART COS.PEL. ref. SIMILAR ref. 702.01218 20847082</p>
	<p>VISIERA PARASOLE PARTE INTERMEDIA (TRASPARENTE) SUN VISOR MIDDLE PART COS.PEL. ref. SIMILAR ref. 702.01219 20527443 Relativo kit staffe 1002.01219</p>
	<p>VISIERA PARASOLE GRIGIO - PARTE SUPERIORE SUN VISOR GREY - UPPER PART COS.PEL. ref. SIMILAR ref. 702.01220 20456709 Relativo kit staffe 1002.01219</p>
	<p>KIT CONVOGLIATORI ARIA A.B.S. - NERO KIT AIR CONVEYOR A.B.S. - BLACK COS.PEL. ref. SIMILAR ref. 902.85000 20391583</p>
	<p>KIT SILENTBLOC GOMMA - NERO - CONFEZIONE DA 4 PEZZI KIT SILENTBLOC RUBBER - BLACK - EACH CARTON 4 PCS COS.PEL. ref. SIMILAR ref. 1002.02004 -</p>
	<p>SUPPORTO TIRANTE CALOTTA POSTERIORE ALLUMINIO REAR MUDGUARD TENSIONER BRACKET ALUMINIUM COS.PEL. ref. SIMILAR ref. 1002.56559 20498620 / 20583434 / 3987252</p>
	<p>SUPPORTO PARAFANGO POSTERIORE ALLUMINIO REAR MUDGUARD BRACKET ALUMINIUM COS.PEL. ref. SIMILAR ref. 1002.56560 20466895</p>

F-H vers.2

	<p>SUPPORTO PARAFANGO POSTERIORE ALLUMINIO REAR MUDGUARD BRACKET ALUMINIUM</p> <p>COS.PEL. ref. SIMILAR ref. 1002.56561 20383038</p>
	<p>SUPPORTO PARAFANGO POSTERIORE ALLUMINIO REAR MUDGUARD BRACKET ALUMINIUM</p> <p>COS.PEL. ref. SIMILAR ref. 1002.56562 20382890</p>
	<p>SUPPORTO TIRANTE INTERNO ALLUMINIO INNER BRACKET ALUMINIUM</p> <p>COS.PEL. ref. SIMILAR ref. 1002.56564 20583440</p>
	<p>GRIGLIA PEDANA CENTRALE E INFERIORE METALLO CENTRAL AND LOWER FOOTSTEP GRILLE METAL</p> <p>COS.PEL. ref. SIMILAR ref. 1002.60788 20360789 DX RH</p> <p>1002.60789 20360788 SX LH</p>
	<p>COPRI BATTERIE P.P.G.F. - NERO BATTERY COVER P.P.G.F. - BLACK</p> <p>COS.PEL. ref. SIMILAR ref. 1002.91005 20507252 / 3127594</p>
	<p>GRIGLIA PEDANA SUPERIORE METALLO UPPER FOOTSTEP GRILLE METAL</p> <p>COS.PEL. ref. SIMILAR ref. 1002.91315 20379439 / 8191315 DX-SX RH-LH</p>
	<p>CORNICE FARO A.B.S. - NERO HEADLAMP FRAME A.B.S. - BLACK</p> <p>COS.PEL. ref. SIMILAR ref. 1102.62550 20452887 / 21469924 DX RH</p> <p>1102.62549 20452886 / 21469918 SX LH</p>
	<p>MODANATURA PER CORNICE FARO A.B.S. - GRIGIO MOULDING FOR HEADLIGHT BEZEL A.B.S. - GREY</p> <p>COS.PEL. ref. SIMILAR ref. 1102.62552 20452848 DX RH</p> <p>1102.62551 20452847 SX LH</p>

	<p>CORNICE FANALINO A.B.S. - NERO LAMP FRAME A.B.S. - BLACK COS.PEL. ref. SIMILAR ref. 1102.62554 20425419 / 20826231 / 21469979 DX RH</p> <p>1102.62553 20425418 / 20826227 / 21430598 SX LH</p>
	<p>RIPARO CORNICE FARO A.B.S. - BIANCO PROTECTING HEADLAMP FRAME A.B.S. - WHITE COS.PEL. ref. SIMILAR ref. 1102.62556 20453931 / 20507021 / 21359260 DX RH</p> <p>1102.62555 20453930 / 20507020 / 21359257 SX LH</p>
	<p>SCATOLA FARO P.P.G.F. - NERO LIGHT HOUSING P.P.G.F. - NERO COS.PEL. ref. SIMILAR ref. 1102.62558 20453628 / 20534601 / 20827044 / 20917958 DX RH</p> <p>1102.62557 20453627 / 20534600 / 20827042 / 20917957 SX LH</p>
	<p>PLASTICA COPRIFARO TRASPARENTE HEADLAMP PROTECTION TRANSPARENT COS.PEL. ref. SIMILAR ref. 1102.62560 20467388 DX RH</p> <p>1102.62559 20467387 SX LH</p>
	<p>CANTONALE METALLO CORNER PANEL METAL COS.PEL. ref. SIMILAR ref. 1202.79176 20379176 DX RH</p> <p>1202.79175 20379175 SX LH</p>
	<p>PROLUNGA PORTA A.B.S. - GRIGIO EXTENSIONE DOOR A.B.S. - GREY COS.PEL. ref. SIMILAR ref. 1402.67038 20467038 / 21300059 DX RH</p> <p>1402.67037 20467037 / 21299955 SX LH</p>
	<p>FANALE LATERALE LED 4 LED - 12 / 24 Volt SIDE LAMP LED 4 LED - 12 / 24 Volt COS.PEL. ref. SIMILAR ref. 003000 20398660 / 20789440 DX-SX RH-LH</p> <p>ARANCIO / ORANGE (12/24 V)</p>
	<p>FANALE LATERALE LAMPADINA ATTACCO AMP - JPT - Relativo connettore 003122 SIDE LAMP BULB CONNECTION AMP - JPT - Related connector 003122 COS.PEL. ref. SIMILAR ref. 003001 20734485 DX-SX RH-LH</p> <p>ARANCIO / ORANGE - Relativo portalamпада 1601.50013</p>









F-H vers.2

	<p>FANALE LATERALE LED 4 LED - ATTACCO AMP-JPT - 12 / 24 Volt SIDE LAMP LED 4 LED - CONNECTION AMP-JPT - 12 / 24 Volt</p> <p>COS.PEL. ref. SIMILAR ref. 003002 -</p> <p style="text-align: right;">DX-SX RH-LH</p> <p style="text-align: right;">ARANCIO / ORANGE (12/24 V)</p>
	<p>BASE FANALINO CENTRALE R5W CENTRAL BASIC R5W</p> <p>COS.PEL. ref. SIMILAR ref. 1602.61658 20425484</p>
	<p>BASE FANALINO LATERALE R5W LATERAL BASIC R5W</p> <p>COS.PEL. ref. SIMILAR ref. 1602.61659 20398824</p> <p style="text-align: right;">DX-SX RH-LH</p>
	<p>LENTE BIANCA WHITE LENS</p> <p>COS.PEL. ref. SIMILAR ref. 1602.61660 1623726</p> <p style="text-align: right;">DX-SX RH-LH</p>
	<p>LENTE ARANCIONE AMBER LENS</p> <p>COS.PEL. ref. SIMILAR ref. 1602.61661 1623727</p> <p style="text-align: right;">DX-SX RH-LH</p>
	<p>ADATTATORE ELETTRICO PER FARI MANUALI 9 PIN HEAD LAMP ADAPTER 9 PIN</p> <p>COS.PEL. ref. SIMILAR ref. 1602.61662 -</p>
 	<p>FANALINO H21W CORNER LAMP H21W</p> <p>COS.PEL. ref. SIMILAR ref. 1602.61670 20409875 / 20826213</p> <p style="text-align: right;">DX RH</p> <p>1602.61669 20409874 / 20826211</p> <p style="text-align: right;">SX LH</p>
	<p>ADATTATORE ELETTRICO PER FARO ELETTRICO 12 PIN HEAD LAMP ADAPTER 12 PIN</p> <p>COS.PEL. ref. SIMILAR ref. 1602.61671 -</p>

 	<p>PROIETTORE H7 - 12 PIN - ATTACCO RETTANGOLARE - PREDISPOSTO PER CORRETTORE ASSETTO HEADLAMP H7 - 12 PIN - RECTANGULAR MOUNT - SUITABLE FOR LOAD LEVEL ADJUSTEMENT COS.PEL. ref. SIMILAR ref. 1602.61664 20763003 / 20861574 / 21001649 DX RH Connettore/Connector : 1602.61671 1602.61663 20763004 / 20861573 / 21001645 SX LH</p>
 	<p>VETRO PROIETTORE HEADLAMP GLASS COS.PEL. ref. SIMILAR ref. 1602.61666 20379429 / 20710525 DX RH 1602.61665 20379428 / 20710524 SX LH</p>
 	<p>PROIETTORE H7 H7 H7 - 9 PIN - ATTACCO ROTONDO - CORRETTORE ASSETTO MANUALE HEADLAMP H7 H7 H7 - 9 PIN - ROUND MOUNT - MANUAL LOAD LEVEL ADJUSTEMENT COS.PEL. ref. SIMILAR ref. 1602.61668 20360899 / 20762993 / 20861576 / 20713721 / 20861584 / 21001668 DX RH 1602.61667 20360898 / 20762992 / 20861583 / 20862575 / 20713720 / 21001663 SX LH</p>
	<p>CERNIERA PORTA INFERIORE DOOR HINGE LOWER COS.PEL. ref. SIMILAR ref. 1702.14605 1062637 / 20372039 DX-SX RH-LH</p>
	<p>CERNIERA PORTA SUPERIORE DOOR HINGE UPPER COS.PEL. ref. SIMILAR ref. 1702.14606 1623248 / 20372038 / 20398136 DX RH 1702.14607 1623147 / 20372037 / 20398135 SX LH</p>
	<p>FERMAPORTA CENTRALE DOOR STOP MIDDLE COS.PEL. ref. SIMILAR ref. 1702.14608 1062636 DX-SX RH-LH</p>
<p>AD ESAURIMENTO SCORTE UNTIL SELL-OUT</p> 	<p>MANIGLIA PORTA CROMATA - SENZA CHIAVE DOOR HANDLE CHROMATE - WITHOUT KEY COS.PEL. ref. SIMILAR ref. 1702.65598 - DX RH 1702.65599 - SX LH</p>
	<p>MANIGLIA PORTA SENZA CHIAVE DOOR HANDLE WITHOUT KEY COS.PEL. ref. SIMILAR ref. 1702.65600 1062566 / 20398467 / 3175919 DX RH 1702.65601 1062565 / 20398466 / 3175918 SX LH</p>

F-H vers.2

	<p>MANIGLIA ESTERNA PARTE INTERNA FRONT PULLER INNER COS.PEL. ref. SIMILAR ref. 1702.65602 20530146 / 3175367 DX RH</p> <p>1702.65603 20383543 SX LH</p>
	<p>MANIGLIA ESTERNA PARTE ESTERNA FRONT PULLER OUTER COS.PEL. ref. SIMILAR ref. 1702.65604 3175366 DX-SX RH-LH</p>
	<p>SERRATURA INTERNA PORTA DOOR INSIDE HANDLE BASE COS.PEL. ref. SIMILAR ref. 1702.65606 1063328 / 8142044 DX RH</p> <p>1702.65605 1063327 / 8142043 SX LH</p>
	<p>SERRATURA PORTA ANTERIORE FRONT DOOR LATCH COS.PEL. ref. SIMILAR ref. 1702.65608 20588326 / 21261275 / 21505894 DX RH</p> <p>1702.65607 20588325 / 21261274 / 21505893 SX LH</p>
	<p>ALZACRISTALLI ELETTRICO ELETTRICO - CON MOTORINO - 2 FILI WINDOW REGULATOR ELECTRIC - WITH MOTOR - 2 WIRES COS.PEL. ref. SIMILAR ref. 1902.65202 3176542 DX RH</p> <p>1902.65203 3176541 SX LH</p>
	<p>VASCHETTA ESPANSIONE EXPANSION TANK COS.PEL. ref. SIMILAR ref. 2102.13080 1676400 / 1676576</p>
	<p>VASCHETTA ESPANSIONE EXPANSION TANK COS.PEL. ref. SIMILAR ref. 2102.64080 1674918</p>
	<p>TIRANTE PARAFANGO GOMMA - NERO MUDGUARD TENSIONER RUBBER - BLACK COS.PEL. ref. SIMILAR ref. 1002.56557 1079981</p>

	<p>TIRANTE PARAFANGO GOMMA - NERO MUDGUARD TENSIONER RUBBER - BLACK</p> <p>COS.PEL. ref. SIMILAR ref. 1002.56558 20498623</p>
	<p>MOLLA A GAS Lunghezza [mm] 685 Corsa [mm] 295 Forza scarto [N] 500 GAS SPRING Lenght [mm] 685 Stroke [mm] 295 Waste force [N] 500</p> <p>COS.PEL. ref. SIMILAR ref. 2402.53100 20379348</p>
	<p>MOLLA A GAS Lunghezza [mm] 393 Corsa [mm] 150 Forza scarto [N] 170 GAS SPRING Lenght [mm] 393 Stroke [mm] 150 Waste force [N] 170</p> <p>COS.PEL. ref. SIMILAR ref. 2402.53101 3981920 / 8143670</p>
	<p>DEFLETTORI LATERALI CON CLIPS SIDEWINDOW DEFLECTORS WITH CLIPS</p> <p>COS.PEL. ref. SIMILAR ref. 3002.00001 -</p>
	<p>KIT PER CONNESSIONI ELETTRICHE Connettore 2 vie JPT KIT FOR ELECTRICAL JOINTS Connector 2 ways JPT</p> <p>COS.PEL. ref. SIMILAR ref. 003122 -</p> <p>Connettore per 003001 - 003003 - 003004</p>
	<p>KIT PER CONNESSIONI ELETTRICHE Connettore SUPERSEAL 2 vie femmina KIT FOR ELECTRICAL JOINTS Connector SUPERSEAL ways female</p> <p>COS.PEL. ref. SIMILAR ref. 003123 -</p> <p>Connettore per la serie 1500.xxxxx</p>
<p>AD ESAURIMENTO SCORTE UNTIL SELL-OUT</p>  <p>cm 16</p>	<p>FANALE POSTERIORE REAR-LIGHT LED</p> <p>COS.PEL. ref. SIMILAR ref. 006007 -</p> <p>Con luce targa / With plate light - conn. 003120</p> <p>TRASPARENTE / LENS 011117 -</p> <p>SX LH DX-SX RH-LH</p>
 <p>cm 16</p>	<p>FANALE POSTERIORE CON CICALINO REAR-LIGHT WITH BUZZER</p> <p>COS.PEL. ref. SIMILAR ref. 006008 21097450</p> <p>Con cicalino / With buzzer - conn. 003120</p> <p>TRASPARENTE / LENS 010080 20425732 / 20910229</p> <p>DX RH DX-SX RH-LH</p>

F-H vers.2

	<p>FANALE POSTERIORE 7 FUNZIONI REAR-LIGHT 7 FUNCTIONS</p> <p>COS.PEL. ref. SIMILAR ref. 006012 20507624 / 20892384 / 21097448 DX RH Relativo connettore 003120 006011 20507623 / 20892386 / 21097449 SX LH Con luce targa / With plate light - conn. 003120 TRASPARENTE / LENS 010080 20425732 / 20910229 DX-SX RH-LH</p>
	<p>FANALE POSTERIORE 7 FUNZIONI REAR-LIGHT 7 FUNCTIONS</p> <p>COS.PEL. ref. SIMILAR ref. 006014 20565104 / 21063895 DX RH Con cicalino / With buzzer - conn. 003120 006013 20565103 / 21063887 SX LH Con luce targa / With plate light - conn. 003120 TRASPARENTE / LENS 010081 20565107 DX-SX RH-LH</p>
	<p>FANALE POSTERIORE LED - 24V - CONNETTORE POSTERIORE AMP 1.5 REAR-LIGHT LED - 24V - REAR CONNECTOR AMP 1.5</p> <p>COS.PEL. ref. SIMILAR ref. 1500.00000 - DX RH - Relativo connettore multipolare 003120 1500.00001 - SX LH - Relativo connettore multipolare 003120 TRASPARENTE / LENS</p>



	<p>GRIGLIA SUPERIORE METALLO UPPER GRILLE STEEL</p> <p>COS.PEL. ref. SIMILAR ref. 102.13100 21190825 / 82056727</p>
	<p>GRIGLIA INFERIORE A.B.S. - BIANCO LOWER GRILLE A.B.S. - WHITE</p> <p>COS.PEL. ref. SIMILAR ref. 102.13102 82056840 / 82065607</p>
	<p>GRIGLIA INFERIORE A.B.S. - BIANCO LOWER GRILLE A.B.S. - WHITE</p> <p>COS.PEL. ref. SIMILAR ref. 102.13103 82065609</p>
	<p>COPERCHIO FRONTALE P.P. - GRIGIO FRONT COVER P.P. - GREY</p> <p>COS.PEL. ref. SIMILAR ref. 102.13104 82063911 DX RH</p> <p>102.13105 82062209 SX LH</p>
	<p>TELAIO GRIGLIA METALLO GRILLE FRAME METAL</p> <p>COS.PEL. ref. SIMILAR ref. 102.13106 82072463</p>

	<p>GRIGLIA FRONTALE P.P. - GRIGIO FRONT GRILLE P.P. - GREY</p> <p>COS.PEL. ref. SIMILAR ref. 102.13107 82063513</p>
	<p>MODANATURA GRIGLIA INFERIORE A.B.S. - GRIGIA LOWER MOLDING GRILLE A.B.S. - GREY</p> <p>COS.PEL. ref. SIMILAR ref. 102.13108 82065120</p>
	<p>TAPPO GRIGLIA INFERIORE A.B.S. - NERO COVER GRILLE A.B.S. - BLACK</p> <p>COS.PEL. ref. SIMILAR ref. 102.53960 20453690 / 20453960 / 21425186 DX-SX RH-LH</p>
	<p>PEDANA PARAFANGO A.B.S. - GRIGIO MUDGUARD FOOTSTEP A.B.S. - GREY</p> <p>COS.PEL. ref. SIMILAR ref. 202.75928 3175928 DX RH</p> <p>202.75927 Griglia/Grille : 1002.60788 inf - 1002.91315 sup 3175927 SX LH</p> <p>Griglia/Grille : 1002.60789 inf - 1002.91315 sup</p>
	<p>PROLUNGA PARAFANGO LATERALE A.B.S. - GRIGIO EXTENSION MUDGUARD A.B.S. - GREY</p> <p>COS.PEL. ref. SIMILAR ref. 202.75930 21302470 / 3175930 DX RH</p> <p>202.75929 3175929 SX LH</p>
	<p>PARAFANGO ANTERIORE RUOTA ANTERIORE A.B.S. - NERO FRONT MUDGUARD FRONT WHEEL A.B.S. - BLACK</p> <p>COS.PEL. ref. SIMILAR ref. 202.75932 20372065 DX RH</p> <p>202.75931 20372064 SX LH</p>
	<p>PARAFANGO POSTERIORE RUOTA ANTERIORE A.B.S. - GRIGIO REAR MUDGUARD FRONT WHEEL A.B.S. - GREY</p> <p>COS.PEL. ref. SIMILAR ref. 202.75935 20453900 DX-SX RH-LH</p>
	<p>CALOTTA PARAFANGO POSTERIORE CON 4 TIRANTI P.P. - NERO REAR MUDGUARD WITH 4 MUDGUARD TENSIONERS P.P. - BLACK</p> <p>COS.PEL. ref. SIMILAR ref. 202.13199 21094387 / 21094457 DX-SX RH-LH</p> <p>(202.13200 versione senza i tiranti)</p>

	<p>CALOTTA PARAFANGO POSTERIORE P.P. - NERO REAR MUDGUARD P.P. - BLACK</p> <p>COS.PEL. ref. SIMILAR ref. 202.13200 21094387</p> <p style="text-align: right;">DX-SX RH-LH</p> <p>Relativo tirante 1002.13005 - (202.13199 versione con i tiranti)</p>
	<p>MEZZO PARAFANGO POSTERIORE (PARTE POSTERIORE) P.P. - NERO REAR MUDGUARD (REAR PART) P.P. - BLACK</p> <p>COS.PEL. ref. SIMILAR ref. 202.13201 21094394</p> <p style="text-align: right;">DX-SX RH-LH</p>
	<p>MEZZO PARAFANGO POSTERIORE PARTE ANT. P.P. - NERO REAR MUDGUARD FRONT PART P.P. - BLACK</p> <p>COS.PEL. ref. SIMILAR ref. 202.13202 21094391 / 21094397</p> <p style="text-align: right;">DX-SX RH-LH</p>
	<p>CALOTTA PARAFANGO POSTERIORE RIBASSATA P.P. - NERO REAR MUDGUARD P.P. - BLACK</p> <p>COS.PEL. ref. SIMILAR ref. 202.13203 21094384 / 21094388</p> <p style="text-align: right;">DX-SX RH-LH</p> <p>Relativo tirante 1002.13005 - (202.13204 versione con i tiranti)</p>
	<p>CALOTTA PARAFANGO POSTERIORE CON 4 TIRANTI P.P. - NERO REAR MUDGUARD WITH 4 MUDGUARD TENSIONERS P.P. - BLACK</p> <p>COS.PEL. ref. SIMILAR ref. 202.13204 21094388 / 21094457</p> <p style="text-align: right;">DX-SX RH-LH</p> <p>(202.13203 versione senza i tiranti)</p>
	<p>PARASPRUZZI ANTISPRAY</p> <p>COS.PEL. ref. SIMILAR ref. 202.13205 20843850</p>
	<p>PARASPRUZZI ANTISPRAY</p> <p>COS.PEL. ref. SIMILAR ref. 202.13206 -</p>
	<p>COPERTURA INTERNA PARAFANGO INNER MUDGUARD FLAP</p> <p>COS.PEL. ref. SIMILAR ref. 202.13207 1079997</p>

	<p>VASCETTA PEDANA P.P. - GRIGIO FOOTSTEP P.P. - GREY COS.PEL. ref. SIMILAR ref. 302.41008 20529640 / 3175407 DX RH</p> <p>302.41007 Griglia/Grille 1002.60788 20529638 / 3175406 SX LH Griglia/Grille 1002.60789</p>
	<p>PARAURTI CENTRALE P.P.T. - PRIMER CENTRAL BUMPER P.P.T. - PRIMER COS.PEL. ref. SIMILAR ref. 402.74997 20425625 / 21359080</p>
	<p>ANGOLO PARAURTI P.P.T. - PRIMER CORNER BUMPER P.P.T. - PRIMER COS.PEL. ref. SIMILAR ref. 402.74998 20425627 / 21359090 DX RH</p> <p>402.74999 20425626 / 21359082 SX LH</p>
	<p>PARAURTI CENTRALE P.P.T. - NERO CENTRAL BUMPER P.P.T. - BLACK COS.PEL. ref. SIMILAR ref. 402.75000 20529740 / 3175417</p>
	<p>ANGOLO PARAURTI P.P. - NERO CORNER BUMPER P.P. - BLACK COS.PEL. ref. SIMILAR ref. 402.75002 20529742 / 3175419 DX RH</p> <p>402.75001 20529741 / 3175418 SX LH</p>
	<p>TERMINALE PARAURTI FRONT TERMINAL SPOILER COS.PEL. ref. SIMILAR ref. 402.75012 20453677 / 20453679 DX RH</p> <p>402.75011 20433678 / 20453676 SX LH</p>
	<p>SPECCHIO GUARDARUOTA RAGGIO 300 ROOF MIRROR RADIUS 300 COS.PEL. ref. SIMILAR ref. 502.13602 20716739 DX-SX RH-LH</p>
	<p>SPECCHIO COMPLETO CON BRACCIO TETTO BASSO TETTO BASSO COMPLETE FRONT MIRROR WITH ARM LOW CAB LOW CAB COS.PEL. ref. SIMILAR ref. 502.13604 20900679 / 21151129</p>

	<p>SPECCHIO COMPLETO CON BRACCIO TETTO ALTO TETTO ALTO COMPLETE FRONT MIRROR WITH ARM HIGH CAB HIGH CAB</p> <p>COS.PEL. ref. SIMILAR ref. 502.13605 20900682 / 21151132</p>
	<p>SPECCHIO COMPLETO GUARDAVANTI MIRROR</p> <p>COS.PEL. ref. SIMILAR ref. 502.13606 20716956</p>
	<p>CERNIERA PER GRIGLIA INFERIORE METALLO HINGE STEEL</p> <p>COS.PEL. ref. SIMILAR ref. 1002.13000 20545095 DX RH</p> <p>1002.13001 20545094 SX LH</p>
	<p>SUPPORTO ALLUMINIO BRACKET ALUMINIUM</p> <p>COS.PEL. ref. SIMILAR ref. 1002.13002 82252302</p>
	<p>CERNIERA PER GRIGLIA INFERIORE METALLO HINGE FOR LOWER GRILLE METAL</p> <p>COS.PEL. ref. SIMILAR ref. 1002.13004 82060445 DX RH</p> <p>1002.13003 82060441 SX LH</p>
	<p>SUPPORTO PARAFANGO POSTERIORE PICCOLO ALLUMINIO REAR MUDGUARD BRACKET ALUMINIUM</p> <p>COS.PEL. ref. SIMILAR ref. 1002.13006 21090272</p>
	<p>SUPPORTO PARAFANGO POSTERIORE GRANDE ALLUMINIO REAR MUDGUARD BRACKET ALUMINIUM</p> <p>COS.PEL. ref. SIMILAR ref. 1002.13007 21213202 / 21213203</p>
	<p>TUBO FISSAGGIO PARAFANGO METALLO - CM 63 REAR MUDGUARD BRACKET STEEL - CM 63</p> <p>COS.PEL. ref. SIMILAR ref. 1002.13008 21094413</p>

	<p>GOMMINO PER TUBO PARAFANGO GOMMA - NERO RUBBER RUBBER - BLACK</p> <p>COS.PEL. ref. SIMILAR ref. 1002.13009 -</p>
	<p>COPRI BATTERIE P.P.G.F. - NERO BATTERY COVER P.P.G.F. - BLACK</p> <p>COS.PEL. ref. SIMILAR ref. 1002.13010 20842848 / 21412897 / 21924923</p>
	<p>RIPARO MARMITTA METALLO SILENCER COVER METAL</p> <p>COS.PEL. ref. SIMILAR ref. 1002.13011 21068469</p>
	<p>RIPARO MARMITTA METALLO SILENCER COVER METAL</p> <p>COS.PEL. ref. SIMILAR ref. 1002.13012 21068473</p>
	<p>RIPARO MARMITTA METALLO SILENCER COVER METAL</p> <p>COS.PEL. ref. SIMILAR ref. 1002.13013 21297258</p>
	<p>RIPARO MARMITTA METALLO SILENCER COVER METAL</p> <p>COS.PEL. ref. SIMILAR ref. 1002.13014 21297261</p>
	<p>CORNICE FARO P.P.G.F. LIGHT HOUSING P.P.G.F.</p> <p>COS.PEL. ref. SIMILAR ref. 1102.13500 82056986 / 82209849 / 82367957 DX RH</p> <p>1102.13501 82053690 / 82209788 / 82367098 SX LH</p>
	<p>CORNICE FARO A.B.S. - BIANCO HEADLAMP FRAME A.B.S. - WHITE</p> <p>COS.PEL. ref. SIMILAR ref. 1102.13502 21478755 / 82076266 DX RH</p> <p>1102.13503 21478759 / 82076158 SX LH</p>

	<p>RIPARO CORNICE FARO A.B.S. - BIANCO PROTECTING HEADLIGHT BEZEL A.B.S. - WHITE COS.PEL. ref. SIMILAR ref. 1102.13504 21451002 / 82056991 DX RH</p> <p>1102.13505 21451000 / 82052484 SX LH</p>
	<p>CORNICE FANALINO A.B.S. - NERO LAMP BEZEL A.B.S. - BLACK COS.PEL. ref. SIMILAR ref. 1102.13506 21478751 / 82114502 DX RH</p> <p>1102.13507 21448885 / 82114504 SX LH</p>
	<p>CORNICE FENDINEBBIA A.B.S. FOG LAMP BEZEL A.B.S. COS.PEL. ref. SIMILAR ref. 1102.13508 21078545 DX RH</p> <p>1102.13509 21078543 SX LH</p>
	<p>CANTONALE METALLO CORNER PANEL METAL COS.PEL. ref. SIMILAR ref. 1202.79176 20379176 DX RH</p> <p>1202.79175 20379175 SX LH</p>
	<p> LUCCIOLA LED CORNER LAMP LED COS.PEL. ref. SIMILAR ref. 1602.13804 82114500 DX RH</p> <p>1602.13805 82114506 SX LH</p>
<p>AD ESAURIMENTO SCORTE UNTIL SELL-OUT</p> 	<p>CABLAGGIO ELETTRICO BULB HOLDER COS.PEL. ref. SIMILAR ref. 1602.13806 82078418</p>
	<p>FANALINO INGOMBRO CABINA LED 2 LED - 24V - LUCE BIANCA DRIVER'S CAB SIDE MARKER LED 2 LED - 24V COS.PEL. ref. SIMILAR ref. 1602.13811 82116545 DX-SX RH-LH</p>
	<p>FANALINO INGOMBRO CABINA LED 2 LED - 24V - ARANCIONE DRIVER'S CAB SIDE MARKER LED 2 LED - 24V - AMBER COS.PEL. ref. SIMILAR ref. 1602.13812 21087346 DX-SX RH-LH</p>









	<p>FANALINO INGOMBRO CABINA LED 2 LED - 24V - VERDE DRIVER'S CAB SIDE MARKER LED 2 LED - 24V - GREEN</p> <p>COS.PEL. ref. SIMILAR ref. 1602.13813 21087347</p> <p style="text-align: right;">DX-SX RH-LH</p>
	<p>PROIETTORE H7 PY21W LED - CORRETTORE ASSETTO MANUALE HEADLAMP H7 PY21W LED - MANUAL LOAD LEVEL ADJUSTEMENT</p> <p>COS.PEL. ref. SIMILAR ref. 1602.13798 21123489 / 82304585</p> <p style="text-align: right;">DX RH</p> <p>1602.13799 21123523 / 82304599</p> <p style="text-align: right;">SX LH</p>
	<p>PROIETTORE H7 H3 - PREDISPOSTO PER CORRETTORE ASSETTO HEADLAMP H7 H3 - SUITABLE FOR LOAD LEVEL ADJUSTEMENT</p> <p>COS.PEL. ref. SIMILAR ref. 1602.13800 21035637 / 21323106</p> <p style="text-align: right;">DX RH</p> <p>1602.13801 21035638 / 21323108</p> <p style="text-align: right;">SX LH</p>
	<p>PROIETTORE LUCE PROFONDITA' H3 - PREDISPOSTO PER CORRETTORE ASSETTO HEADLAMP H3 - SUITABLE FOR LOAD LEVEL ADJUSTEMENT</p> <p>COS.PEL. ref. SIMILAR ref. 1602.13802 21035690 / 21297909</p> <p style="text-align: right;">DX RH</p> <p>1602.13803 21035692 / 21297911</p> <p style="text-align: right;">SX LH</p>
	<p>PROIETTORE XENON SENZA CENTRALINA D2S H7 PY21W LED - PREDISPOSTO PER CORRETTORE ASSETTO HEADLAMP XENON W/O CONTROL UNIT D2S H7 PY21W LED - SUITABLE FOR LOAD LEVEL ADJUSTEMENT</p> <p>COS.PEL. ref. SIMILAR ref. 1602.13808 21035644 / 21323113</p> <p style="text-align: right;">DX RH</p> <p>1602.13807 21035645 / 21323114</p> <p style="text-align: right;">SX LH</p>
	<p>FENDINEBBIA H3 H3 FOG LAMP H3 H3</p> <p>COS.PEL. ref. SIMILAR ref. 1602.13810 21297917</p> <p style="text-align: right;">DX RH</p> <p>1602.13809 21297918</p> <p style="text-align: right;">SX LH</p>
	<p>CERNIERA PORTA INFERIORE DOOR HINGE LOWER</p> <p>COS.PEL. ref. SIMILAR ref. 1702.14605 1062637 / 20372039</p> <p style="text-align: right;">DX-SX RH-LH</p>
	<p>CERNIERA PORTA SUPERIORE DOOR HINGE UPPER</p> <p>COS.PEL. ref. SIMILAR ref. 1702.14606 1623248 / 20372038 / 20398136</p> <p style="text-align: right;">DX RH</p> <p>1702.14607 1623147 / 20372037 / 20398135</p> <p style="text-align: right;">SX LH</p>

	<p>FERMAPORTA CENTRALE DOOR STOP MIDDLE</p> <p>COS.PEL. ref. SIMILAR ref. 1702.14608 1062636</p> <p style="text-align: right;">DX-SX RH-LH</p>
	<p>ALZACRISTALLI ELETTRICO - CON MOTORINO - 2 FILI WINDOW REGULATOR ELECTRIC - WITH MOTOR - 2 WIRES</p> <p>COS.PEL. ref. SIMILAR ref. 1902.65202 3176542</p> <p style="text-align: right;">DX RH</p> <p>1902.65203 3176541</p> <p style="text-align: right;">SX LH</p>
	<p>TIRANTE CALOTTA GOMMA - NERO MUDGUARD TENSIONER RUBBER - BLACK</p> <p>COS.PEL. ref. SIMILAR ref. 1002.13005 21094457</p>
	<p>MOLLA A GAS Lunghezza [mm] 685 Corsa [mm] 295 Forza scarto [N] 500 GAS SPRING Lenght [mm] 685 Stroke [mm] 295 Waste force [N] 500</p> <p>COS.PEL. ref. SIMILAR ref. 2402.53100 20379348</p>
	<p>DEFLETTORI LATERALI CON CLIPS SIDEWINDOW DEFLECTORS WITH CLIPS</p> <p>COS.PEL. ref. SIMILAR ref. 3002.00001 -</p>
	<p>KIT PER CONNESSIONI ELETTRICHE Connettore AMP 1,5 singolo KIT FOR ELECTRICAL JOINTS Connector AMP 1,5 simple</p> <p>COS.PEL. ref. SIMILAR ref. 003120 -</p>
	<p>FANALE POSTERIORE LED - 24V - CONNETTORE LATERALE AMP 1.5 REAR-LIGHT LED - 24V - LATERAL CONNECTOR AMP 1.5</p> <p>COS.PEL. ref. SIMILAR ref. 1502.14000 82849923 / 84195521 / 84441768 DX RH Relativo connettore 003120 1502.14001 82849894 / 84195505 / 84441766 SX LH Con luce targa / With plate light - Relativo connettore 003120</p> <p>TRASPARENTE / LENS 1502.14100 82849905 DX-SX RH-LH</p>
	<p>FANALE POSTERIORE LED - 24V - CONNETTORE LATERALE AMP 1.5 REAR-LIGHT LED - 24V - LATERAL CONNECTOR AMP 1.5</p> <p>COS.PEL. ref. SIMILAR ref. 1502.14002 82849925 / 84195519 / 84441767 DX RH Con cicalino / With buzzer - Relativo connettore 003120</p> <p>TRASPARENTE / LENS 1502.14100 82849905 DX-SX RH-LH</p>

F-H 4



	<p>FRONTALE METALLO FRONTAL PANEL STEEL</p> <p>COS.PEL. ref. SIMILAR ref. 102.14100 82360122</p>
	<p>GRIGLIA INFERIORE A.B.S. LOWER GRILLE A.B.S.</p> <p>COS.PEL. ref. SIMILAR ref. 102.14101 82491903</p>
	<p>PANNELLO A.B.S. PANEL A.B.S.</p> <p>COS.PEL. ref. SIMILAR ref. 102.14102 84027588</p>
	<p>PANNELLO ANGOLARE A.B.S. PANEL CORNER COVER A.B.S.</p> <p>COS.PEL. ref. SIMILAR ref. 102.14104 82858516 DX RH</p> <p>102.14103 82858486 SX LH</p>
	<p>LISTELLO CROMATO INFERIORE MARK (CHROME) LOWER</p> <p>COS.PEL. ref. SIMILAR ref. 102.14105 82248327</p>

	<p>LISTELLO CROMATO CENTRALE MARK (CHROME) MIDDLE</p> <p>COS.PEL. ref. SIMILAR ref. 102.14106 82248338</p> <p>102.14107 82248340</p> <p style="text-align: right;">DX RH SX LH</p>
	<p>LISTELLO CROMATO SUPERIORE MARK (CHROME) UPPER</p> <p>COS.PEL. ref. SIMILAR ref. 102.14108 82248325</p>
	<p>GRIGLIA RADIATORE SUPERIORE INTERNA METALLO - NERO PROTECTOR GARNISH UPPER INSIDE STEEL - BLACK</p> <p>COS.PEL. ref. SIMILAR ref. 102.14109 82258426</p>
	<p>GRIGLIA SUPERIORE ABS - NERO PROTECTOR GARNISH UPPER MIDDLE ABS - BLACK</p> <p>COS.PEL. ref. SIMILAR ref. 102.14110 82208512 / 82220161</p>
	<p>CORNICE GRIGLIA SUPERIORE ABS - NERO PROTECTOR GARNISH UPPER OUTSIDE ABS - BLACK</p> <p>COS.PEL. ref. SIMILAR ref. 102.14111 82180491</p>
	<p>GRIGLIA INFERIORE INTERNA METALLO - NERO PROTECTOR GARNISH LOWER INSIDE STEEL - BLACK</p> <p>COS.PEL. ref. SIMILAR ref. 102.14112 82255346</p>
	<p>GRIGLIA INFERIORE ABS - NERO PROTECTOR GARNISH LOWER MIDDLE ABS - BLACK</p> <p>COS.PEL. ref. SIMILAR ref. 102.14113 82220206 / 82298657</p>
	<p>CORNICE GRIGLIA INFERIORE ABS - NERO PROTECTOR GARNISH LOWER OUTSIDE ABS - BLACK</p> <p>COS.PEL. ref. SIMILAR ref. 102.14114 82177794</p>

F-H 4

	<p>GRIGLIA FRONTALE A.B.S. FRONT PANEL GRILLE A.B.S.</p> <p>COS.PEL. ref. SIMILAR ref. 102.14115 82219161 / 84033228</p>
	<p>SUPPORTO FARO HEAD LAMP CASE</p> <p>COS.PEL. ref. SIMILAR ref. 102.14116 82285617 / 84058023 DX RH</p> <p>102.14117 84024496 / 84046776 SX LH</p>
	<p>TAPPO FRONTALE FRONT PANEL COVER</p> <p>COS.PEL. ref. SIMILAR ref. 102.14118 82846116 DX RH</p> <p>102.14119 82846118 SX LH</p>
	<p>GRIGLIA INFERIORE LOWER GRILLE</p> <p>COS.PEL. ref. SIMILAR ref. 102.14122 82298483</p>
	<p>PROLUNGA PARAFANGO A.B.S. EXTENSION MUDGUARD A.B.S.</p> <p>COS.PEL. ref. SIMILAR ref. 202.14200 21413763 / 84233571 DX RH</p>
	<p>PROLUNGA PARAFANGO A.B.S. EXTENSION MUDGUARD A.B.S.</p> <p>COS.PEL. ref. SIMILAR ref. 202.14201 21940892 SX LH</p>
	<p>RIPAROFANGO MUDGUARD</p> <p>COS.PEL. ref. SIMILAR ref. 202.14202 21094406 DX-SX RH-LH</p>
	<p>SPORTELLLO PROLUNGA PARAFANGO A.B.S. COVER EXTENSION MUDGUARD A.B.S.</p> <p>COS.PEL. ref. SIMILAR ref. 202.14203 21413732 / 82181355 SX LH</p>

 <p>cm 10</p>	<p>PARAFANGHINO LATERALE P.P. FRONT MUDGUARD SEAL P.P. COS.PEL. ref. SIMILAR ref. 202.14204 82328081 / 84096589 DX RH</p> <p>202.14205 82328082 / 84096588 SX LH</p>
	<p>PARAFANGO ANTERIORE (PARTE POSTERIORE) MO- P.P. FRONT MUDGUARD (REAR PART) P.P. COS.PEL. ref. SIMILAR ref. 202.14207 82637695 / 84007259 DX-SX RH-LH</p>
	<p>PARAFANGO ANTERIORE PARTE ANTERIORE FRONT MUDGUARD FRONT WHEEL COS.PEL. ref. SIMILAR ref. 202.14208 82141524 DX RH</p> <p>202.14209 82110404 SX LH</p>
	<p>PARAFANGO ANTERIORE PARTE POSTERIORE P.P. - TRATTORE MUDGUARD P.P. COS.PEL. ref. SIMILAR ref. 202.14210 82637711 DX RH</p> <p>202.14211 82637710 SX LH</p>
 <p>cm 65 cm 105 cm 18</p>	<p>CALOTTA PARAF. RIBASSATA CON 4 TIRANTI P.P. - NERO - 2010 REAR MUDGUARD FLAT WITH 4 M. TENSIONERS P.P. - BLACK - 2010 COS.PEL. ref. SIMILAR ref. 201.30545 21094389 / 21094457 DX-SX RH-LH</p> <p>(201.30547 versione senza i tiranti)</p>
 <p>cm 65 cm 105 cm 18</p>	<p>CALOTTA PARAFANGO RIBASSATA P.P. - NERO - 2010 REAR MUDGUARD FLAT P.P. - BLACK - TYPE 2010 COS.PEL. ref. SIMILAR ref. 201.30547 21094389 DX-SX RH-LH</p> <p>Tirante : 1002.13005 - (201.30545 versione con i tiranti)</p>
 <p>cm 71 cm 60 cm 57</p>	<p>MEZZO PARAFANGO POSTERIORE P.P. - NERO - PARTE ANTERIORE - 2010 REAR MUDGUARD P.P. - BLACK - FRONT PART - TYPE 2010 COS.PEL. ref. SIMILAR ref. 201.30550 21094392 DX RH</p> <p>201.30549 21094393 SX LH</p>
 <p>cm 67 cm 117 cm 18</p>	<p>CALOTTA PARAFANGO POSTERIORE CON 4 TIRANTI P.P. - NERO REAR MUDGUARD WITH 4 MUDGUARD TENSIONERS P.P. - BLACK COS.PEL. ref. SIMILAR ref. 202.13199 21094387 / 21094457 DX-SX RH-LH</p> <p>(202.13200 versione senza i tiranti)</p>

	<p>CALOTTA PARAFANGO POSTERIORE P.P. - NERO REAR MUDGUARD P.P. - BLACK</p> <p>COS.PEL. ref. 202.13200 SIMILAR ref. 21094387</p> <p style="text-align: right;">DX-SX RH-LH</p> <p style="text-align: center;">Relativo tirante 1002.13005 - (202.13199 versione con i tiranti)</p>
	<p>MEZZO PARAFANGO POSTERIORE (PARTE POSTERIORE) P.P. - NERO REAR MUDGUARD (REAR PART) P.P. - BLACK</p> <p>COS.PEL. ref. 202.13201 SIMILAR ref. 21094394</p> <p style="text-align: right;">DX-SX RH-LH</p>
	<p>MEZZO PARAFANGO POSTERIORE PARTE ANT. P.P. - NERO REAR MUDGUARD FRONT PART P.P. - BLACK</p> <p>COS.PEL. ref. 202.13202 SIMILAR ref. 21094391 / 21094397</p> <p style="text-align: right;">DX-SX RH-LH</p>
	<p>CALOTTA PARAFANGO POSTERIORE RIBASSATA P.P. - NERO REAR MUDGUARD P.P. - BLACK</p> <p>COS.PEL. ref. 202.13203 SIMILAR ref. 21094384 / 21094388</p> <p style="text-align: right;">DX-SX RH-LH</p> <p style="text-align: center;">Relativo tirante 1002.13005 - (202.13204 versione con i tiranti)</p>
	<p>CALOTTA PARAFANGO POSTERIORE CON 4 TIRANTI P.P. - NERO REAR MUDGUARD WITH 4 MUDGUARD TENSIONERS P.P. - BLACK</p> <p>COS.PEL. ref. 202.13204 SIMILAR ref. 21094388 / 21094457</p> <p style="text-align: right;">DX-SX RH-LH</p> <p style="text-align: center;">(202.13203 versione senza i tiranti)</p>
	<p>PEDANA INFERIORE A.B.S. LOWER FOOTSTEP A.B.S.</p> <p>COS.PEL. ref. 302.14100 SIMILAR ref. 21344649 / 21392187</p> <p style="text-align: right;">DX RH</p> <p>302.14101 Griglia / Grille : 1002.14018 21344647 / 21392183 SX LH</p> <p style="text-align: center;">Griglia / Grille : 1002.14019</p>
	<p>PEDANA CENTRALE A.B.S. CENTRAL FOOTSTEP A.B.S.</p> <p>COS.PEL. ref. 302.14102 SIMILAR ref. 82141521</p> <p style="text-align: right;">DX RH</p> <p>302.14103 Griglia / Grille : 1002.14022 82136982 SX LH</p> <p style="text-align: center;">Griglia / Grille : 1002.14021</p>
	<p>PEDANA SUPERIORE A.B.S. UPPER FOOTSTEP A.B.S.</p> <p>COS.PEL. ref. 302.14104 SIMILAR ref. 82819477</p> <p style="text-align: right;">DX RH</p> <p>302.14105 Griglia / Grille : 1002.14032 82819482 SX LH</p> <p style="text-align: center;">Griglia / Grille : 1002.14033</p>

	<p>PEDANA INFERIORE A.B.S. - GRIGIO GOFFRATO LOWER FOOTSTEP A.B.S. - GREY COS.PEL. ref. SIMILAR ref.</p> <p>302.14106 82142373 DX RH</p> <p>302.14107 Griglia / Grille : 1002.14018 82141971 SX LH</p> <p>Griglia / Grille : 1002.14019</p>
	<p>PARAURTI CENTRALE A.B.S. - GRIGIO CENTRAL BUMPER A.B.S. - GREY</p> <p>COS.PEL. ref. SIMILAR ref.</p> <p>402.14084 21316576 / 22249883</p>
	<p>ANGOLO PARAURTI A.B.S. - GRIGIO CORNER BUMPER A.B.S. - GREY COS.PEL. ref. SIMILAR ref.</p> <p>402.14086 21316577 DX RH</p> <p>402.14085 21316575 SX LH</p>
	<p>PARAURTI CENTRALE A.B.S. - PRIMER CENTRAL BUMPER A.B.S. - PRIMER</p> <p>COS.PEL. ref. SIMILAR ref.</p> <p>402.14087 82090733 / 84195623</p>
	<p>ANGOLO PARAURTI A.B.S. - PRIMER CORNER BUMPER A.B.S. - PRIMER COS.PEL. ref. SIMILAR ref.</p> <p>402.14088 21413786 / 82090735 DX RH</p> <p>402.14089 21413789 / 82090731 SX LH</p>
	<p>PARAURTI CENTRALE A.B.S. - LISCIO NERO CENTRAL BUMPER A.B.S. - BLACK</p> <p>COS.PEL. ref. SIMILAR ref.</p> <p>402.14090 21413787</p>
	<p>ANGOLO PARAURTI A.B.S. - LISCIO NERO CORNER BUMPER A.B.S. - BLACK COS.PEL. ref. SIMILAR ref.</p> <p>402.14092 21413786 DX RH</p> <p>402.14091 21413789 SX LH</p>
	<p>SOTTOPARAURTI CENTRALE GRIGIO GOFFRATO P.P. LOWER BUMPER SPOILER P.P. - GREY</p> <p>COS.PEL. ref. SIMILAR ref.</p> <p>402.14093 82101912</p>

F-H 4

	<p>ANGOLO SOTTOPARAURTI P.P. - GRIGIO CORNER LOWER UMPER P.P. - GREY COS.PEL. ref. SIMILAR ref. 402.14094 82101914 DX RH</p> <p>402.14095 82101910 SX LH</p>
	<p>SOTTOPARAURTI CENTRALE P.P. - PRIMER LOWER BUMPER SPOILER P.P. - PRIMER COS.PEL. ref. SIMILAR ref. 402.14096 21495267</p>
	<p>ANGOLO SOTTOPARAURTI P.P. - PRIMER CORNER LOWER BUMPER P.P. - PRIMER COS.PEL. ref. SIMILAR ref. 402.14098 21495268 DX RH</p> <p>402.14097 21495266 SX LH</p>
	<p>PARAURTI CENTRALE METALLO - NERO CENTRAL BUMPER STEEL - BLACK COS.PEL. ref. SIMILAR ref. 402.14099 21838427 / 22247766 FONDO</p>
	<p>ANGOLO PARAURTI METALLO - NERO CORNER BUMPER STEEL - BLACK COS.PEL. ref. SIMILAR ref. 402.14100 21838939 / 21838945 FONDO DX RH</p> <p>402.14101 21838944 FONDO / 21868931 SX LH</p>
	<p>SPECCHIO RETROVISORE REAR-VIEW MIRROR COS.PEL. ref. SIMILAR ref. 502.14500 82943356 DX RH</p> <p>502.14501 82943538 SX LH</p>
	<p>VETRO GRANDE BIG GLASS COS.PEL. ref. SIMILAR ref. 502.14502 82359214 DX RH</p> <p>502.14503 82356810 SX LH</p>
	<p>VETRO SPECCHIO GRANDANGOLO MIRROR GLASS WIDE ANGLE COS.PEL. ref. SIMILAR ref. 502.14504 82356824 DX-SX RH-LH</p>

	<p>CALOTTA FOTOINCISA GRIGIA COVER GREY COS.PEL. ref. SIMILAR ref. 502.14506 82268562</p> <p>502.14505 82268557</p> <p style="text-align: right;">DX RH</p> <p style="text-align: right;">SX LH</p>
	<p>CALOTTA LISCIA NERA COVER BLACK COS.PEL. ref. SIMILAR ref. 502.14508 21766009 / 82945196</p> <p>502.14507 21765994 / 82944866</p> <p style="text-align: right;">DX RH</p> <p style="text-align: right;">SX LH</p>
	<p>SPECCHIO FRONTALE ROOF MIRROR</p> <p>COS.PEL. ref. SIMILAR ref. 502.14509 84004927</p>
	<p>SPECCHIO KERB MIRROR</p> <p>COS.PEL. ref. SIMILAR ref. 502.14510 84004929 / 84167321</p>
	<p>VISIERA SUN VISOR</p> <p>COS.PEL. ref. SIMILAR ref. 702.14900 82131055 / 84014254</p> <p style="text-align: right;">Kit staffe: 1002.14023 (cab.alta/high) 1002.14024 (cab.bassa/low)</p>
	<p>VISIERA PARASOLE PARTE SUPERIORE SUNVISOR OUTSIDE</p> <p>COS.PEL. ref. SIMILAR ref. 702.14901 21443604 / 82166469</p>
	<p>KIT CONVOGLIATORE ARIA ABS - BIANCO DIRT DEFLECTOR ABS - WHITE</p> <p>COS.PEL. ref. SIMILAR ref. 902.14077 -</p> <p style="text-align: right;">DX-SX RH-LH</p>
	<p>SERRATURA GRIGLIA FRONT PANEL LOCK</p> <p>COS.PEL. ref. SIMILAR ref. 1002.14002 82213089</p> <p>1002.14001 82232959</p> <p style="text-align: right;">DX RH</p> <p style="text-align: right;">SX LH</p>

	<p>CORNICE FARO A.B.S. HEADLAMP FRAME A.B.S. COS.PEL. ref. SIMILAR ref. 1102.14600 21874457 DX RH</p> <p>1102.14601 21874450 SX LH</p>
	<p>CANALE ARIA PER CORNICE FARO A.B.S. AIR CONVEYOR FOR HEADLIGHT BEZEL A.B.S. COS.PEL. ref. SIMILAR ref. 1102.14602 82884084 DX RH</p> <p>1102.14603 82884080 SX LH</p>
	<p>TAPPO CORNICE P.P. FRAME COVER P.P. COS.PEL. ref. SIMILAR ref. 1102.14604 82453926 DX RH</p> <p>1102.14605 82446592 SX LH</p>
	<p>TAPPO CORNICE P.P. FRAME COVER P.P. COS.PEL. ref. SIMILAR ref. 1102.14606 21413774 DX RH</p> <p>1102.14607 21413734 SX LH</p>
	<p>RIPARO CORNICE FARO POSTERIORE P.P. HEADLAMP BACK COVER P.P. COS.PEL. ref. SIMILAR ref. 1102.14608 82462703 / 84034942 / 84139933 DX RH Relative clips : 1002.14610</p> <p>1102.14609 82462702 / 84034945 / 84139886 SX LH Relative clips : 1002.14610</p>
	<p>CLIPS CLIPS COS.PEL. ref. SIMILAR ref. 1102.14610 -</p>
	<p>PROLUNGA PORTA METALLO EXTENSIONE DOOR STEEL COS.PEL. ref. SIMILAR ref. 1402.14500 21642399 / 82178247 DX RH</p> <p>1402.14501 21642377 / 82107271 SX LH</p>
	<p> FANALINO LATERALE LED SIDE LAMP LED COS.PEL. ref. SIMILAR ref. 1602.14810 82151205 DX RH</p> <p>1602.14809 82151157 SX LH</p>

F-H 4

COS.VO

 	<p>FANALINO LATERALE LED LED CORNER LAMP LED LED</p> <p>COS.PEL. ref. SIMILAR ref. 1602.14812 21346522</p> <p>1602.14811 21346521</p> <p style="text-align: right;">DX RH</p> <p style="text-align: right;">SX LH</p>
 	<p>PROIETTORE SENZA CENTRALINA H7 H1 PY21 LED - CORRETTORE ASSETTO MANUALE HEADLAMP W/O CONTROL UNIT H7 H1 PY21 LED - MANUAL LOAD LEVEL ADJUSTEMENT</p> <p>COS.PEL. ref. SIMILAR ref. 1602.14800 21221129 / 22239217</p> <p>1602.14801 21221130 / 22239219</p> <p style="text-align: right;">DX RH</p> <p style="text-align: right;">SX LH</p>
 	<p>PROIETTORE SENZA CENTRALINA H7 H1 PY21 LED - CORRETTORE ASSETTO MANUALE HEADLAMP W/O CONTROL UNIT H7 H1 PY21 LED - MANUAL LOAD LEVEL ADJUSTEMENT</p> <p>COS.PEL. ref. SIMILAR ref. 1602.14802 21608661 / 22239225</p> <p>1602.14803 21608663 / 22239226</p> <p style="text-align: right;">DX RH</p> <p style="text-align: right;">SX LH</p>
 	<p>PROIETTORE XENON SENZA CENTRALINA D1S H1 PY21 LED - CORRETTORE ASSETTO MANUALE HEADLAMP XENON W/O CONTROL UNIT D1S H1 PY21 LED - MANUAL LOAD LEVEL ADJUSTEMENT</p> <p>COS.PEL. ref. SIMILAR ref. 1602.14804 21221145 / 22239248</p> <p>1602.14805 21221142 / 22239254</p> <p style="text-align: right;">DX RH</p> <p style="text-align: right;">SX LH</p>
 	<p>PROIETTORE SENZA CENTRALINA LED - CON MOTORINO - H7,H1,PY21W HEADLAMP W/O CONTROL UNIT LED - WITH MOTOR - H7,H1,PY21W</p> <p>COS.PEL. ref. SIMILAR ref. 1602.14808 21221133 / 22239220</p> <p>1602.14807 21221134 / 22239221</p> <p style="text-align: right;">DX RH</p> <p style="text-align: right;">SX LH</p>
 	<p>PROIETTORE SENZA CENTRALINA LED - CON MOTORINO - H7,H1,PY21W HEADLAMP W/O CONTROL UNIT LED - WITH MOTOR - H7,H1,PY21W</p> <p>COS.PEL. ref. SIMILAR ref. 1602.14814 21608666 / 22239232</p> <p>1602.14813 21608667 / 22239234</p> <p style="text-align: right;">DX RH</p> <p style="text-align: right;">SX LH</p>
 	<p>FENDINEBBIA BASE CROMATA H1 - H7 - BASE CROMATA FOG LAMP H1 - H7 - CHROME BASE</p> <p>COS.PEL. ref. SIMILAR ref. 1602.14816 21221153 / 22332594</p> <p>1602.14815 21221154 / 22332595</p> <p style="text-align: right;">DX RH</p> <p style="text-align: right;">SX LH</p>
 	<p>FENDINEBBIA H7 - BASE NERA FOG LAMP H7 - BLACK BASE</p> <p>COS.PEL. ref. SIMILAR ref. 1602.14818 21221155 / 22332596</p> <p>1602.14817 21221156 / 22332597</p> <p style="text-align: right;">DX RH</p> <p style="text-align: right;">SX LH</p>

	<p>FENDINEBBIA H1 - H7 - BASE NERA FOG LAMP H1 - H7 - BLACK BASE COS.PEL. ref. SIMILAR ref. 1602.14820 21221158 / 22332600 DX RH</p> <p>1602.14819 21221157 / 22332598 SX LH</p>
	<p>FENDINEBBIA H7 - H7 - BASE NERA FOG LAMP H7 - H7 - BLACK BASE COS.PEL. ref. SIMILAR ref. 1602.14822 21221159 / 22332603 DX RH</p> <p>1602.14821 21221160 / 22332604 SX LH</p>
	<p>FENDINEBBIA H7 - BASE CROMATA FOG LAMP H7 - CHROMED BASE COS.PEL. ref. SIMILAR ref. 1602.14824 21221151 / 22332592 DX RH</p> <p>1602.14823 21221152 / 22332593 SX LH</p>
	<p>SCONTRIO SERRATURA METALLO STRIKER PLATE METAL COS.PEL. ref. SIMILAR ref. 1702.14604 82208564</p>
	<p>CERNIERA PORTA INFERIORE DOOR HINGE LOWER COS.PEL. ref. SIMILAR ref. 1702.14605 1062637 / 20372039 DX-SX RH-LH</p>
	<p>CERNIERA PORTA SUPERIORE DOOR HINGE UPPER COS.PEL. ref. SIMILAR ref. 1702.14606 1623248 / 20372038 / 20398136 DX RH</p> <p>1702.14607 1623147 / 20372037 / 20398135 SX LH</p>
	<p>FERMAPORTA CENTRALE DOOR STOP MIDDLE COS.PEL. ref. SIMILAR ref. 1702.14608 1062636 DX-SX RH-LH</p>
	<p>TIRANTE CALOTTA GOMMA - NERO MUDGUARD TENSIONER RUBBER - BLACK COS.PEL. ref. SIMILAR ref. 1002.13005 21094457</p>

F-H 4

	<p>MOLLA A GAS Lunghezza [mm] 513 Corsa [mm] 216,5 Forza scarto [N] 150 GAS SPRING Lenght [mm] 513 Stroke [mm] 216,5 Waste force [N] 150</p> <p>COS.PEL. ref. SIMILAR ref. 2402.44100 1619106</p>
	<p>DEFLETTORI LATERALI CON FASCIA ADESIVA SIDEWINDOW DEFLECTORS WITH ADHESIVE TAPE</p> <p>COS.PEL. ref. SIMILAR ref. 3002.00000 84429873</p>
	<p>KIT PER CONNESSIONI ELETTRICHE Connettore AMP 1,5 singolo KIT FOR ELECTRICAL JOINTS Connector AMP 1,5 simple</p> <p>COS.PEL. ref. SIMILAR ref. 003120 -</p>
	<p>FANALE POSTERIORE LED - 24V - CONNETTORE LATERALE AMP 1.5 REAR-LIGHT LED - 24V - LATERAL CONNECTOR AMP 1.5</p> <p>COS.PEL. ref. SIMILAR ref. 1502.14000 82849923 / 84195521 / 84441768 DX RH Relativo connettore 003120 1502.14001 82849894 / 84195505 / 84441766 SX LH Con luce targa / With plate light - Relativo connettore 003120</p> <p>TRASPARENTE / LENS 1502.14100 82849905 DX-SX RH-LH</p>
	<p>FANALE POSTERIORE LED - 24V - CONNETTORE LATERALE AMP 1.5 REAR-LIGHT LED - 24V - LATERAL CONNECTOR AMP 1.5</p> <p>COS.PEL. ref. SIMILAR ref. 1502.14002 82849925 / 84195519 / 84441767 DX RH Con cicalino / With buzzer - Relativo connettore 003120</p> <p>TRASPARENTE / LENS 1502.14100 82849905 DX-SX RH-LH</p>
	<p>FANALE POSTERIORE LED - 24V - CONNETTORE LATERALE AMP 1.5 REAR-LIGHT LED - 24V - LATERAL CONNECTOR AMP 1.5</p> <p>COS.PEL. ref. SIMILAR ref. 1502.14004 21735299 / 84441937 DX RH Relativo connettore 003120 1502.14003 21735301 / 84441936 SX LH Relativo connettore 003120</p> <p>TRASPARENTE / LENS 1502.14101 84122332 DX-SX RH-LH</p>
	<p>FANALE POSTERIORE LED - 24V - CONNETTORE LATERALE AMP 1.5 REAR-LIGHT LED - 24V - LATERAL CONNECTOR AMP 1.5</p> <p>COS.PEL. ref. SIMILAR ref. 1502.14006 82483073 / 84441760 DX RH Con cicalino / With buzzer - Relativo connettore 003120 1502.14005 82483074 / 84441759 SX LH Con luce targa / With plate light - Relativo connettore 003120</p> <p>TRASPARENTE / LENS 1502.14101 84122332 DX-SX RH-LH</p>







Parti di ricambio adattabili a:
Spare parts suitable to:



<p>AD ESAURIMENTO SCORTE UNTIL STOCK-OUT</p> 	<p>GRIGLIA STRATIFICAZIONE MANUALE - BIANCO GRILLE G.R.P. - WHITE</p> <p>COS.PEL. ref. SIMILAR ref. 103.08292 1317538</p>
<p>AD ESAURIMENTO SCORTE UNTIL STOCK-OUT</p> 	<p>FIANCHETTO LATERALE CORTO STRATIFICAZIONE MANUALE - BIANCO SHORT CORNER PANEL G.R.P. - WHITE</p> <p>COS.PEL. ref. SIMILAR ref. 1203.25251 388309</p> <p style="text-align: right;">SX LH</p>



	<p>GRIGLIA SUPERIORE P.P.G.F. - BIANCO UPPER GRILLE P.P.G.F. - WHITE</p> <p>COS.PEL. ref. SIMILAR ref. 103.97571 1397571</p>
<p>AD ESAURIMENTO SCORTE UNTIL SPILL-OUT</p> 	<p>GRIGLIA SUPERIORE METALLO UPPER GRILLE STEEL</p> <p>COS.PEL. ref. SIMILAR ref. 103.97572 1401931</p>
<p>AD ESAURIMENTO SCORTE UNTIL SPILL-OUT</p> 	<p>GRIGLIA INFERIORE METALLO LOWER GRILLE STEEL</p> <p>COS.PEL. ref. SIMILAR ref. 103.97573 1371754</p>
	<p>CALANDRA ANTERIORE INFERIORE METALLO LOWER GRILLE STEEL</p> <p>COS.PEL. ref. SIMILAR ref. 103.43124 1366384</p>
	<p>GRIGLIA CENTRALE RADIATORE METALLO CENTRAL GRILLE RADIATOR STEEL</p> <p>COS.PEL. ref. SIMILAR ref. 103.43134 1366243 / 1366832 / 1870689</p>

	<p>PARAFANGO ANTERIORE SX POSTERIORE DX A.B.S. - GRIGIO FRONT MUDGUARD LH REAR RH A.B.S. - GREY</p> <p>COS.PEL. ref. SIMILAR ref. 203.08465 1335391 / 1408465 / 1485485 SX LH</p>
	<p>PARAFANGO ANTERIORE DX POSTERIORE SX A.B.S. - GRIGIO FRONT MUDGUARD RH REAR LH A.B.S. - GREY</p> <p>COS.PEL. ref. SIMILAR ref. 203.08466 1335392 / 1408466 / 1485486 DX RH</p>
	<p>COPERCHIO PARAFANGO A.B.S. - GRIGIO COVER MUDGUARD A.B.S. - GREY</p> <p>COS.PEL. ref. SIMILAR ref. 203.68652 1368652 / 2026619 / 2026621 DX RH</p> <p>203.68651 1362708 / 2026618 / 2026620 SX LH</p>
	<p>MEZZO PARAFANGO POSTERIORE SX ANTERIORE DX P.P.T. - GRIGIO REAR MUDGUARD LH FRONT RH P.P.T. - GREY</p> <p>COS.PEL. ref. SIMILAR ref. 203.44599 1357599 SX LH</p>
	<p>MEZZO PARAFANGO POSTERIORE DX ANTERIORE SX P.P.T. - GRIGIO REAR MUDGUARD RH FRONT LH P.P.T. - GREY</p> <p>COS.PEL. ref. SIMILAR ref. 203.44600 1357600 DX RH</p>
	<p>CALOTTA PARAF. POST. RIBASSATA CON 4 TIRANTI P.P.T. - GRIGIO REAR MUDGUARD FLAT TYPE WITH 4 MUDG. TENS. P.P.T. - GREY</p> <p>COS.PEL. ref. SIMILAR ref. 203.57601 1357602 / 1383858 DX-SX RH-LH</p> <p>(203.57602 versione senza i tiranti)</p>
	<p>CALOTTA PARAFANGO POSTERIORE RIBASSATA P.P.T. - GRIGIO REAR MUDGUARD FLAT TYPE P.P.T. - GREY</p> <p>COS.PEL. ref. SIMILAR ref. 203.57602 1357602 DX-SX RH-LH</p> <p>Relativo tirante 1003.00144 - (203.57601 versione con i tiranti)</p>
	<p>CALOTTA PARAF. POST. INTERM. CON 4 TIRANTI P.P.T. - GRIGIO REAR MUDGUARD WITH 4 MUDGUARD TENSIONERS P.P.T. - GREY</p> <p>COS.PEL. ref. SIMILAR ref. 203.95275 1383858 / 1395276 DX-SX RH-LH</p> <p>(203.95276 versione senza i tiranti)</p>

 <p>cm 18 cm 75 cm 97</p>	<p>CALOTTA PARAFANGO POSTERIORE INTERMEDIO P.P.T. - GRIGIO REAR MUDGUARD STANDARD P.P.T. - GREY</p> <p>COS.PEL. ref. SIMILAR ref. 203.95276 1395276 DX-SX RH-LH</p> <p>Relativo tirante 1003.00144 - (203.95275 versione con i tiranti)</p>
	<p>PARETE PEDANA METALLO STEP PANEL STEEL</p> <p>COS.PEL. ref. SIMILAR ref. 303.11050 1351194 / 1515194 DX RH</p> <p>303.11051 1351193 / 1515195 SX LH</p>
 <p>cm 17 cm 45</p>	<p>COPERCHIO PEDANA CENTRALE A.B.S. - NERO COVER CENTRAL FOOTSTEP A.B.S. - BLACK</p> <p>COS.PEL. ref. SIMILAR ref. 303.11052 1354594 DX RH</p> <p>303.11053 1354593 SX LH</p>
	<p>COPERCHIO PEDANA SUPERIORE A.B.S. - NERO COVER UPPER FOOTSTEP A.B.S. - BLACK</p> <p>COS.PEL. ref. SIMILAR ref. 303.11054 1390074 DX RH</p> <p>303.11055 1390075 SX LH</p>
	<p>PARAURTO ANTERIORE METALLO FRONT BUMPER STEEL</p> <p>COS.PEL. ref. SIMILAR ref. 403.76832 1376832 / 1499231 / 1515190</p>
 <p>cm 70 cm 45</p>	<p>CONVOGLIATORE ARIA S.M.C. - GRIGIO AIR CONVEYOR S.M.C. - GREY</p> <p>COS.PEL. ref. SIMILAR ref. 903.23236 1386958 / 1537675 DX RH</p> <p>903.23235 1386957 SX LH</p>
	<p>CONVOGLIATORE ARIA ESTERNO A.B.S. - NERO EXTERIOR CORNER PANEL A.B.S. - BLACK</p> <p>COS.PEL. ref. SIMILAR ref. 903.86960 1370108 DX RH</p> <p>903.86959 1370107 SX LH</p>
	<p>CONVOGLIATORE ARIA INTERNO A.B.S. - NERO INNER CORNER PANEL A.B.S. - BLACK</p> <p>COS.PEL. ref. SIMILAR ref. 903.86962 1386960 DX RH</p> <p>903.86961 1386959 SX LH</p>

	<p>SUPPORTO TIRANTE PARAFANGO POSTERIORE METALLO REAR MUDGUARD TENSIONER STEEL</p> <p>COS.PEL. ref. SIMILAR ref. 1003.00007 1383520</p>
	<p>CERNIERA CONVOGLIATORE ARIA METALLO AIR CONVEYOR BRACKET STEEL</p> <p>COS.PEL. ref. SIMILAR ref. 1003.00010 1381564 / 1440113 / 1726851 DX RH</p> <p>1003.00009 1381563 / 1440108 SX LH</p>
	<p>CERNIERA GRIGLIA SUPERIORE METALLO UPPER GRILLE HINGE STEEL</p> <p>COS.PEL. ref. SIMILAR ref. 1003.00012 1366288 / 1383888 / 1393447 DX RH</p> <p>1003.00011 1366287 / 1383887 SX LH</p>
	<p>CERNIERA GRIGLIA INFERIORE METALLO LOWER GRILLE HINGE STEEL</p> <p>COS.PEL. ref. SIMILAR ref. 1003.00014 1381480 DX RH</p> <p>1003.00013 1381479 SX LH</p>
	<p>GRIGLIA PEDANA INFERIORE ALLUMINIO LOWER STEP PLATE ALUMINIUM</p> <p>COS.PEL. ref. SIMILAR ref. 1003.00015 1390076 / 1535049 DX-SX RH-LH</p>
	<p>GRIGLIA PEDANA SUPERIORE ALLUMINIO UPPER STEP PLATE ALUMINIUM</p> <p>COS.PEL. ref. SIMILAR ref. 1003.00016 1351203 / 1535045 DX-SX RH-LH</p>
	<p>SUPPORTO PARAFANGO POSTERIORE METALLO CON RINFORZO REAR MUDGUARD BRACKET STEEL</p> <p>COS.PEL. ref. SIMILAR ref. 1003.00020 (1523608 rinforzo) / 1400900 / 1457896 / 1725672 / 1742386 DX RH</p> <p>1003.00019 (1523607 rinforzo) / 1400899 / 1457895 / 1725671 / 2054603 SX LH</p>
	<p>SUPPORTO PARAFANGO POSTERIORE METALLO CON RINFORZO REAR MUDGUARD BRACKET METAL WITH REINFORCING</p> <p>COS.PEL. ref. SIMILAR ref. 1003.00024 (1523608 rinforzo) / 1358316 / 1457888 / 1725664 / 1742378 / 2054602 / 2057120 DX RH</p> <p>1003.00023 (1523607 rinforzo) / 1358315 / 1457887 / 1725663 / 1742377 / 2054601 / 2057119 SX LH</p>

	<p>CORNICE FARO A.B.S. - NERO HEADLAMP FRAME A.B.S. - BLACK COS.PEL. ref. SIMILAR ref. 1103.24600 1324600 / 1543635 DX RH</p> <p>1103.24599 1324599 / 1543634 SX LH</p>
	<p>SERRATURA PORTA ANTERIORE FRONT DOOR LATCH COS.PEL. ref. SIMILAR ref. 1703.30224 1406224 / 1789306 / 1902976 DX RH</p> <p>1703.30223 1406223 / 1789305 / 1902975 SX LH</p>
	<p>ARRESTO PORTA DOOR STOP COS.PEL. ref. SIMILAR ref. 1703.30225 1426927 / 1857591 / 1930649 DX-SX RH-LH</p>
	<p>CERNIERA APRI GRIGLIA GRILLE CATCH HANDLE COS.PEL. ref. SIMILAR ref. 1703.30226 1767631</p>
	<p>CERNIERA GRIGLIA CABINA BASSA HOOD LATCH LOWER CAB COS.PEL. ref. SIMILAR ref. 1703.30230 1800468 DX RH</p> <p>1703.30229 1800467 SX LH</p>
	<p>SERRATURA PORTA DOOR LOCK COS.PEL. ref. SIMILAR ref. 1703.30232 1789312 / 1867655 DX RH</p> <p>1703.30231 1789311 / 1867654 SX LH</p>
	<p>TIRANTE PARAFANGO GOMMA - NERO MUDGUARD TENSIONER RUBBER - BLACK COS.PEL. ref. SIMILAR ref. 1003.00144 1383858</p>

R - CP



	<p>GRIGLIA METALLO GRILLE STEEL</p> <p>COS.PEL. ref. SIMILAR ref. 103.43100 1543607</p>
	<p>GRIGLIA SUPERIORE METALLO UPPER GRILLE STEEL</p> <p>COS.PEL. ref. SIMILAR ref. 103.45143 1459134 / 1880737</p>
	<p>GRIGLIA INFERIORE METALLO LOWER GRILLE STEEL</p> <p>COS.PEL. ref. SIMILAR ref. 103.45144 1459135</p>
	<p>GRIGLIA CENTRALE METALLO CENTRAL GRILLE STEEL</p> <p>COS.PEL. ref. SIMILAR ref. 103.43101 1743177 / 1748086</p>
	<p>GRIGLIA CENTRALE GRILLE</p> <p>COS.PEL. ref. SIMILAR ref. 103.45152 1459146</p>

	<p>GRIGLIA INFERIORE PC + ABS - BIANCO LOWER GRILLE PC + ABS - WHITE</p> <p>COS.PEL. ref. SIMILAR ref. 103.45146 1536807</p>
	<p>GRIGLIA SUPERIORE CALANDRA INFERIORE METALLO UPPER GRILLE STEEL</p> <p>COS.PEL. ref. SIMILAR ref. 103.45147 1459141</p>
	<p>GRIGLIA INFERIORE CALANDRA INFERIORE METALLO LOWER GRILLE STEEL</p> <p>COS.PEL. ref. SIMILAR ref. 103.45148 1459142</p>
	<p>SUPPORTO FRONTALE SUPPORT GRILLE</p> <p>COS.PEL. ref. SIMILAR ref. 103.43102 1746586 / 1751661 / 1858803 / 1904814 / 2008861</p>
	<p>PANNELLO SOTTOPARABREZZA WIPER PANEL</p> <p>COS.PEL. ref. SIMILAR ref. 103.46162 1451271 DX RH</p> <p>103.46163 1451270 SX LH</p>
	<p>PANNELLO SOTTOPARABREZZA CENTRALE WIPER PANEL MIDDLE</p> <p>COS.PEL. ref. SIMILAR ref. 103.46164 1866913</p>
	<p>ANGOLO PARAUTI P.C.+A.B.S. - GRIGIO CORNER BUMPER P.C.+A.B.S. - GREY</p> <p>COS.PEL. ref. SIMILAR ref. 403.45134 1439789 DX RH</p> <p>403.45133 1439788 SX LH</p>
	<p>SUPPORTO PARAUTI METALLO SUPPORT BUMPER STEEL</p> <p>COS.PEL. ref. SIMILAR ref. 403.45137 1422843 / 1731206 / 1763296</p>

R - CP

	<p>ANGOLO PARAURTI NERO - METALLO CORNER BUMPER STEEL - BLACK COS.PEL. ref. SIMILAR ref. 403.45138 1853165</p> <p>403.45139 1853164</p> <p style="text-align: right;">DX RH</p> <p style="text-align: right;">SX LH</p>
	<p>PARAURTI CENTRALE METALLO - NERO CENTRAL BUMPER STEEL - BLACK COS.PEL. ref. SIMILAR ref. 403.45140 1548053</p>
	<p>CONVOGLIATORE ARIA S.M.C. - BIANCO AIR CONVEYOR S.M.C. - WHITE COS.PEL. ref. SIMILAR ref. 903.43160 1543609 / 2165864</p> <p>903.43161 1543608 / 2165863</p> <p style="text-align: right;">DX RH</p> <p style="text-align: right;">SX LH</p>
	<p>CONVOGLIATORE ARIA INTERNO A.B.S. - NERO INNER CORNER PANEL A.B.S. - BLACK COS.PEL. ref. SIMILAR ref. 903.43162 1496294 / 1856472</p> <p>903.43163 1496293 / 1856473</p> <p style="text-align: right;">DX RH</p> <p style="text-align: right;">SX LH</p>
	<p>CERNIERA GRIGLIA INFERIORE PARAURTI BASSO HINGE COS.PEL. ref. SIMILAR ref. 1003.43100 1889298</p> <p>1003.43101 1889297</p> <p style="text-align: right;">DX RH</p> <p style="text-align: right;">SX LH</p>
	<p>PANNELLO PORTA INTERNO INNER DOOR PANEL COS.PEL. ref. SIMILAR ref. 1403.46006 1346164</p> <p>1403.46005 1346163</p> <p style="text-align: right;">DX RH</p> <p style="text-align: right;">SX LH</p>
	<p>MOLLA A GAS Lunghezza [mm] 785 Corsa [mm] 345 Forza scarto [N] 250 GAS SPRING Lenght [mm] 785 Stroke [mm] 345 Waste force [N] 250 COS.PEL. ref. SIMILAR ref. 2403.43100 1481372 / 2031866</p>
	<p>MOLLA A GAS Lunghezza [mm] 685 Corsa [mm] 295 Forza scarto [N] 250 GAS SPRING Lenght [mm] 685 Stroke [mm] 295 Waste force [N] 250 COS.PEL. ref. SIMILAR ref. 2403.43101 1481373 / 2031868</p>

	<p>MOLLA A GAS Lunghezza [mm] 486 Corsa [mm] 200 Forza scarto [N] 250 GAS SPRING Lenght [mm] 486 Stroke [mm] 200 Waste force [N] 250</p> <p>COS.PEL. ref. SIMILAR ref. 2403.44100 1306492</p>
	<p>MOLLA A GAS Lunghezza [mm] 195,5 Corsa [mm] 60 Forza scarto [N] 100 GAS SPRING Lenght [mm] 195,5 Stroke [mm] 60 Waste force [N] 100</p> <p>COS.PEL. ref. SIMILAR ref. 2403.44101 1374642</p>
	<p>KIT PER CONNESSIONI ELETTRICHE Connettore AMP 1,5 singolo KIT FOR ELECTRICAL JOINTS Connector AMP 1,5 simple</p> <p>COS.PEL. ref. SIMILAR ref. 003120 -</p>
	<p>FANALE POSTERIORE CONNETTORE LATERALE AMP 1.5 REAR-LIGHT LATERAL CONNECTOR AMP 1.5</p> <p>COS.PEL. ref. SIMILAR ref. 1503.45006 1756751 / 2021575 / 2129987 DX RH (ex 005722) - Relativo connettore 003120 1503.45007 1756754 / 2021579 / 2129985 SX LH Con luce targa / With plate light (ex 005721) - Connettore 003120</p> <p>TRASPARENTE / LENS 1503.45102 1784670 / 2129991 ex 011212/009212 DX RH 1503.45103 1784669 / 2129992 ex 011213/009213 SX LH</p>
	<p>FANALE POSTERIORE CONNETTORE LATERALE AMP 1.5 REAR-LIGHT LATERAL CONNECTOR AMP 1.5</p> <p>COS.PEL. ref. SIMILAR ref. 1503.45008 1791369 / 2021576 / 2129988 DX RH Con cicalino / With buzzer (ex 005724) - Connettore 003120 1503.45009 2021578 / 2129986 SX LH Senza luce targa / W-O Plate light - Connettore 003120</p> <p>TRASPARENTE / LENS 1503.45102 1784670 / 2129991 ex 011212/009212 DX RH 1503.45103 1784669 / 2129992 ex 011213/009213 SX LH</p>

CR 142 - CR 143 Top Line



<p>AD ESAURIMENTO SCORTE UNTIL STOCK OUT</p> 	<p>GRIGLIA STRATIFICAZIONE MANUALE - BIANCO GRILLE G.R.P. - WHITE</p> <p>COS.PEL. ref. SIMILAR ref. 103.43421 1302696</p>
	<p>PARAFANGO ANTERIORE STRATIFICAZIONE MANUALE - BIANCO FRONT MUDGUARD G.R.P. - WHITE</p> <p>COS.PEL. ref. SIMILAR ref. 203.42432 388170 DX RH</p> <p>203.42431 388169 SX LH</p>
	<p>PARAFANGO POSTERIORE STRATIFICAZIONE MANUALE - BIANCO REAR MUDGUARD G.R.P. - WHITE</p> <p>COS.PEL. ref. SIMILAR ref. 203.42434 288178 DX RH</p> <p>203.42433 288177 SX LH</p>
	<p>CALOTTA PARAFANGO POSTERIORE P.P.T. - NERO REAR MUDGUARD P.P.T. - BLACK</p> <p>COS.PEL. ref. SIMILAR ref. 203.13592 1313592 DX-SX RH-LH</p>
	<p>MEZZO PARAFANGO POSTERIORE P.P.T. - NERO REAR MUDGUARD P.P.T. - BLACK</p> <p>COS.PEL. ref. SIMILAR ref. 203.13594 1313594 DX-SX RH-LH</p>

CR 142 - CR 143 Top Line

 <p>cm 66 cm 68 cm 16</p>	<p>MEZZO PARAFANGO POSTERIORE A.B.S. - NERO REAR MUDGUARD A.B.S. - BLACK</p> <p>COS.PEL. ref. SIMILAR ref. 203.50419 350419</p> <p style="text-align: right;">DX-SX RH-LH</p>
 <p>cm 67 cm 89 cm 14.5</p>	<p>CALOTTA PARAFANGO POSTERIORE A.B.S. - NERO REAR MUDGUARD A.B.S. - BLACK</p> <p>COS.PEL. ref. SIMILAR ref. 203.50420 350420</p> <p style="text-align: right;">DX-SX RH-LH</p>
	<p>PARAURTI ANTERIORE METALLO FRONT BUMPER STEEL</p> <p>COS.PEL. ref. SIMILAR ref. 403.03318 1303318</p>
	<p>SOTTOPARAURTI S.M.C. - GRIGIO SPOILER S.M.C. - GREY</p> <p>COS.PEL. ref. SIMILAR ref. 403.00001 330749</p>
	<p>VETRO SPECCHIO (417X220mm) MIRROR GLASS (417X220mm)</p> <p>COS.PEL. ref. SIMILAR ref. 503.11111 296538</p> <p style="text-align: right;">DX-SX RH-LH</p>
	<p>VETRO SPECCHIO RISCALDATO - (417X220mm) MIRROR GLASS HEATED - (417X220mm)</p> <p>COS.PEL. ref. SIMILAR ref. 503.22222 376243</p> <p style="text-align: right;">DX-SX RH-LH</p>
	<p>VETRO SPECCHIO GRANDANGOLO - (253x150mm) MIRROR GLASS WIDE ANGLE - (253x150mm)</p> <p>COS.PEL. ref. SIMILAR ref. 503.55555 316918</p> <p style="text-align: right;">DX RH</p>
	<p>VISIERA PARASOLE S.M.C. - GRIGIO SUN VISOR S.M.C. - GREY</p> <p>COS.PEL. ref. SIMILAR ref. 703.00001 316756</p>

CR 142 - CR 143 Top Line

	<p>CONVOGLIATORE ARIA A.B.S. - NERO AIR CONVEYOR A.B.S. - BLACK COS.PEL. ref. SIMILAR ref. 903.23232 390304</p> <p>903.23231 390303</p> <p style="text-align: right;">DX RH</p> <p style="text-align: right;">SX LH</p>
<p>AD ESAURIMENTO SCORTE UNTIL STOCK-OUT</p> 	<p>KIT MONTAGGIO SOTTOPARAURTI METALLO SPOILER MOUNTING KIT STEEL COS.PEL. ref. SIMILAR ref. 1003.00001 581076</p>
<p>AD ESAURIMENTO SCORTE UNTIL STOCK-OUT</p> 	<p>SUPPORTO RADIATORE METALLO CON GOMMA RADIATOR BRACKET STEEL WITH RUBBER COS.PEL. ref. SIMILAR ref. 1003.00005 391555</p>
	<p>CALOTTA PORTA FARO A.B.S. - NERO LIGHT HOUSING A.B.S. - BLACK COS.PEL. ref. SIMILAR ref. 1103.00831 1300831 / 1300832</p> <p style="text-align: right;">DX-SX RH-LH</p>
	<p>FIANCHETTO LATERALE STRATIFICAZIONE MANUALE - BIANCO CORNER PANEL G.R.P. - WHITE COS.PEL. ref. SIMILAR ref. 1203.24242 388312</p> <p style="text-align: right;">DX RH</p> <p>1203.24241 388311</p> <p style="text-align: right;">SX LH</p>
 	<p>PROIETTORE H4 - CORRETTORE ASSETTO MANUALE HEADLAMP H4 - MANUAL LOAD LEVEL ADJUSTEMENT COS.PEL. ref. SIMILAR ref. 1603.13074 1308474</p> <p>1603.13073 1308473</p> <p style="text-align: right;">DX RH</p> <p style="text-align: right;">SX LH</p>
	<p>ALZACRISTALLI ELETTRICO - CON MOTORINO - 2 PIN WINDOW REGULATOR ELECTRIC - WITH MOTOR - 2 PIN COS.PEL. ref. SIMILAR ref. 1903.14350 1406614</p> <p style="text-align: right;">DX RH</p> <p>1903.14351 1406613</p> <p style="text-align: right;">SX LH</p>
 <p style="text-align: center;">cm 15,3</p>	<p>FANALE POSTERIORE REAR-LIGHT COS.PEL. ref. SIMILAR ref. 005920 1350340</p> <p>005930 1350339</p> <p>TRASPARENTE / LENS 011111 1350343</p> <p style="text-align: right;">DX RH</p> <p style="text-align: right;">SX LH</p> <p style="text-align: right;">DX-SX RH-LH</p>







	<p>GRIGLIA STRATIFICAZIONE MANUALE - BIANCO GRILLE G.R.P. - WHITE</p> <p>COS.PEL. ref. SIMILAR ref. 103.43450 1334054</p>
	<p>PARAFANGO LATERALE STRATIFICAZIONE MANUALE - BIANCO MUDGUARD G.R.P. - WHITE</p> <p>COS.PEL. ref. SIMILAR ref. 203.25266 1325266</p> <p>203.25265 1325265</p> <p style="text-align: right;">DX RH SX LH</p>
	<p>CALOTTA PARAFANGO POSTERIORE P.P.T. - NERO REAR MUDGUARD P.P.T. - BLACK</p> <p>COS.PEL. ref. SIMILAR ref. 203.13592 1313592</p> <p style="text-align: right;">DX-SX RH-LH</p>
	<p>MEZZO PARAFANGO POSTERIORE P.P.T. - NERO REAR MUDGUARD P.P.T. - BLACK</p> <p>COS.PEL. ref. SIMILAR ref. 203.13594 1313594</p> <p style="text-align: right;">DX-SX RH-LH</p>
	<p>COPRI PEDANA A.B.S. - NERO FOOTSTEP A.B.S. - BLACK</p> <p>COS.PEL. ref. SIMILAR ref. 303.10058 1110058</p> <p>303.10057 1110057</p> <p style="text-align: right;">DX RH SX LH</p>

Streamline

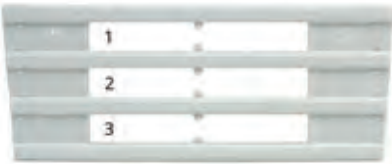
	<p>PARAURTI ANTERIORE A.B.S. - NERO FRONT BUMPER A.B.S. - BLACK COS.PEL. ref. SIMILAR ref. 403.29552 1329552</p> <p>403.29551 1329551</p> <p style="text-align: right;">DX RH</p> <p style="text-align: right;">SX LH</p>
<p>AD ESAURIMENTO SCORTE UNTIL SKILL-OUT</p> 	<p>SUPPORTO PARAURTI METALLO BUMPER BRACKET STEEL COS.PEL. ref. SIMILAR ref. 1003.00004 1326524</p> <p>1003.00003 1326523</p> <p style="text-align: right;">DX RH</p> <p style="text-align: right;">SX LH</p>
	<p>CORNICE FARO STRATIFICAZIONE MANUALE - BIANCO HEADLAMP FRAME G.R.P. - WHITE COS.PEL. ref. SIMILAR ref. 1103.39396 393357</p> <p>1103.39395 393356</p> <p style="text-align: right;">DX RH</p> <p style="text-align: right;">SX LH</p>
<p>AD ESAURIMENTO SCORTE UNTIL SKILL-OUT</p> 	<p>PROLUNGA PORTA R.T.M. - BIANCO EXTENSION DOOR R.T.M. - WHITE COS.PEL. ref. SIMILAR ref. 1403.09584 1309585</p> <p>1403.09585 1309584</p> <p style="text-align: right;">DX RH</p> <p style="text-align: right;">SX LH</p>
	<p>MANIGLIA PORTA CON CHIAVE DOOR HANDLE WITH KEY COS.PEL. ref. SIMILAR ref. 1703.20074 1306976</p> <p>1703.20075 1306975</p> <p style="text-align: right;">DX RH</p> <p style="text-align: right;">SX LH</p>



	<p>GRIGLIA SUPERIORE P.P.G.F. - BIANCO UPPER GRILLE P.P.G.F. - WHITE</p> <p>COS.PEL. ref. SIMILAR ref. 103.43144 1371856 / 1397570</p>
	<p>GRIGLIA SUPERIORE METALLO UPPER GRILLE STEEL</p> <p>COS.PEL. ref. SIMILAR ref. 103.01929 1366736 / 1401929</p>
	<p>GRIGLIA CENTRALE METALLO CENTRAL GRILLE STEEL</p> <p>COS.PEL. ref. SIMILAR ref. 103.71757 1371757</p>
	<p>GRIGLIA INFERIORE METALLO LOWER GRILLE STEEL</p> <p>COS.PEL. ref. SIMILAR ref. 103.71758 1371758</p>
	<p>CALANDRA ANTERIORE INFERIORE METALLO LOWER GRILLE STEEL</p> <p>COS.PEL. ref. SIMILAR ref. 103.43124 1366384</p>





	<p>GRIGLIA CENTRALE RADIATORE METALLO CENTRAL GRILLE RADIATOR STEEL</p> <p>COS.PEL. ref. SIMILAR ref. 103.43134 1366243 / 1366832 / 1870689</p>
	<p>FRONTALE SUPERIORE P.P.G.F. - GRIGIO UPPER FRONT PANEL P.P.G.F. - GREY</p> <p>COS.PEL. ref. SIMILAR ref. 103.83609 1383609</p>
	<p>PARAFANGO ANTERIORE SX POSTERIORE DX A.B.S. - GRIGIO FRONT MUDGUARD LH REAR RH A.B.S. - GREY</p> <p>COS.PEL. ref. SIMILAR ref. 203.08465 1335391 / 1408465 / 1485485 SX LH</p>
	<p>PARAFANGO ANTERIORE DX POSTERIORE SX A.B.S. - GRIGIO FRONT MUDGUARD RH REAR LH A.B.S. - GREY</p> <p>COS.PEL. ref. SIMILAR ref. 203.08466 1335392 / 1408466 / 1485486 DX RH</p>
	<p>PARAFANGO LATERALE PARTE POSTERIORE A.B.S. - GRIGIO MUDGUARD A.B.S. - GREY</p> <p>COS.PEL. ref. SIMILAR ref. 203.08468 1364666 DX RH</p> <p>203.08467 1364665 SX LH</p>
	<p>PROFILO PARAFANGO LATERALE ANTERIORE A.B.S. - GRIGIO MUDGUARD A.B.S. - GREY</p> <p>COS.PEL. ref. SIMILAR ref. 203.08470 1324606 / 1429394 / 1517650 DX RH</p> <p>203.08469 1324605 / 1429393 / 1517649 SX LH</p>
	<p>COPERCHIO PARAFANGO A.B.S. - GRIGIO COVER MUDGUARD A.B.S. - GREY</p> <p>COS.PEL. ref. SIMILAR ref. 203.68652 1368652 / 2026619 / 2026621 DX RH</p> <p>203.68651 1362708 / 2026618 / 2026620 SX LH</p>
 <p style="font-size: small;">cm 70 cm 68,5 cm 18</p>	<p>MEZZO PARAFANGO POSTERIORE SX ANTERIORE DX P.P.T. - GRIGIO REAR MUDGUARD LH FRONT RH P.P.T. - GREY</p> <p>COS.PEL. ref. SIMILAR ref. 203.44599 1357599 SX LH</p>

	<p>MEZZO PARAFANGO POSTERIORE DX ANTERIORE SX P.P.T. - GRIGIO REAR MUDGUARD RH FRONT LH P.P.T. - GREY</p> <p>COS.PEL. ref. SIMILAR ref. 203.44600 1357600</p> <p style="text-align: right;">DX RH</p>
	<p>CALOTTA PARAF. POST. RIBASSATA CON 4 TIRANTI P.P.T. - GRIGIO REAR MUDGUARD FLAT TYPE WITH 4 MUDG. TENS. P.P.T. - GREY</p> <p>COS.PEL. ref. SIMILAR ref. 203.57601 1357602 / 1383858</p> <p style="text-align: right;">DX-SX RH-LH</p> <p>(203.57602 versione senza i tiranti)</p>
	<p>CALOTTA PARAFANGO POSTERIORE RIBASSATA P.P.T. - GRIGIO REAR MUDGUARD FLAT TYPE P.P.T. - GREY</p> <p>COS.PEL. ref. SIMILAR ref. 203.57602 1357602</p> <p style="text-align: right;">DX-SX RH-LH</p> <p>Relativo tirante 1003.00144 - (203.57601 versione con i tiranti)</p>
	<p>CALOTTA PARAF. POST. INTERM. CON 4 TIRANTI P.P.T. - GRIGIO REAR MUDGUARD WITH 4 MUDGUARD TENSIONERS P.P.T. - GREY</p> <p>COS.PEL. ref. SIMILAR ref. 203.95275 1383858 / 1395276</p> <p style="text-align: right;">DX-SX RH-LH</p> <p>(203.95276 versione senza i tiranti)</p>
	<p>CALOTTA PARAFANGO POSTERIORE INTERMEDIO P.P.T. - GRIGIO REAR MUDGUARD STANDARD P.P.T. - GREY</p> <p>COS.PEL. ref. SIMILAR ref. 203.95276 1395276</p> <p style="text-align: right;">DX-SX RH-LH</p> <p>Relativo tirante 1003.00144 - (203.95275 versione con i tiranti)</p>
	<p>CALOTTA PARAFANGO POSTERIORE ALTA P.P.T. - GRIGIO HIGH REAR MUDGUARD P.P.T. - GREY</p> <p>COS.PEL. ref. SIMILAR ref. 203.95277 1357601</p> <p style="text-align: right;">DX-SX RH-LH</p> <p>Relativo tirante 1003.00144 - (203.95278 versione con i tiranti)</p>
	<p>CALOTTA PARAFANGO POST. ALTA CON 4 TIRANTI P.P.T. - GRIGIO HIGH REAR MUDGUARD RH-LH W/TENSIONERS P.P.T. - GREY</p> <p>COS.PEL. ref. SIMILAR ref. 203.95278 1357601 / 1383858</p> <p style="text-align: right;">DX-SX RH-LH</p> <p>203.95277 : versione senza i tiranti</p>
	<p>PARETE PEDANA METALLO STEP PANEL STEEL</p> <p>COS.PEL. ref. SIMILAR ref. 303.11050 1351194 / 1515194</p> <p style="text-align: right;">DX RH</p> <p>303.11051 1351193 / 1515195</p> <p style="text-align: right;">SX LH</p>

 <p>cm 17 cm 45</p>	<p>COPERCHIO PEDANA CENTRALE A.B.S. - NERO COVER CENTRE FOOTSTEP A.B.S. - BLACK COS.PEL. ref. SIMILAR ref. 303.11052 1354594</p> <p>303.11053 1354593</p> <p style="text-align: right;">DX RH SX LH</p>
	<p>COPERCHIO PEDANA SUPERIORE A.B.S. - NERO COVER UPPER FOOTSTEP A.B.S. - BLACK COS.PEL. ref. SIMILAR ref. 303.11054 1390074</p> <p>303.11055 1390075</p> <p style="text-align: right;">DX RH SX LH</p>
 <p>cm 29 cm 135</p>	<p>PARAURTI CENTRALE A.B.S. - GRIGIO CENTRAL BUMPER A.B.S. - GREY COS.PEL. ref. SIMILAR ref. 403.24596 1324596 / 1400213</p>
 <p>cm 50 cm 36</p>	<p>ANGOLO PARAURTI A.B.S. - GRIGIO CORNER BUMPER A.B.S. - GREY COS.PEL. ref. SIMILAR ref. 403.24598 1324598</p> <p>403.24597 1324597</p> <p style="text-align: right;">DX RH SX LH</p>
	<p>RINFORZO PARAURTI ANTERIORE METALLO SUPPORT BUMPER STEEL COS.PEL. ref. SIMILAR ref. 403.24599 1395871 / 1482070 / 1499230</p>
	<p>SPECCHIO GUARDARUOTA RAGGIO 300 ROOF MIRROR RADIUS 300 COS.PEL. ref. SIMILAR ref. 503.45014 1484080</p>
	<p>BRACCIO SPECCHIO FRONTALE TETTO ALTO TETTO ALTO ARM FRONT MIRROR HIGH CAB HIGH CAB COS.PEL. ref. SIMILAR ref. 503.45016 1484079</p>
	<p>BRACCIO SPECCHIO FRONTALE TETTO MEDIO TETTO MEDIO ARM FRONT MIRROR MEDIUM CAB MEDIUM CAB COS.PEL. ref. SIMILAR ref. 503.45017 1484078</p>

 <p>cm 67 cm 58.5 cm 61</p>	<p>CARENATURA ANTERIORE CON STAFFE (PASSO 3550mm) - STRATIFICAZIONE MANUALE - BIANCO FRONT FAIRING WITH BRACKETS (WHEEL BASE 3550mm) - G.R.P. - WHITE</p> <p>COS.PEL. ref. SIMILAR ref. 803.96659 1496659 / 1496666</p> <p style="text-align: right;">DX RH</p>
	<p>CONVOGLIATORE ARIA P.P.G.F. - GRIGIO AIR CONVEYOR P.P.G.F. - GREY</p> <p>COS.PEL. ref. SIMILAR ref. 903.23234 1370330</p> <p style="text-align: right;">DX RH</p> <p>903.23233 1370329</p> <p style="text-align: right;">SX LH</p>
	<p>CONVOGLIATORE ARIA ESTERNO A.B.S. - NERO EXTERIOR CORNER PANEL A.B.S. - BLACK</p> <p>COS.PEL. ref. SIMILAR ref. 903.70100 1382728</p> <p style="text-align: right;">DX RH</p> <p>903.70101 1382727</p> <p style="text-align: right;">SX LH</p>
	<p>CONVOGLIATORE ARIA INTERNO A.B.S. - NERO INNER CORNER PANEL A.B.S. - BLACK</p> <p>COS.PEL. ref. SIMILAR ref. 903.70102 1381566</p> <p style="text-align: right;">DX RH</p> <p>903.70103 1381565</p> <p style="text-align: right;">SX LH</p>
	<p>SUPPORTO TIRANTE PARAFANGO POSTERIORE METALLO REAR MUDGUARD TENSIONER STEEL</p> <p>COS.PEL. ref. SIMILAR ref. 1003.00007 1383520</p>
	<p>CERNIERA CONVOGLIATORE ARIA METALLO AIR CONVEYOR BRACKET STEEL</p> <p>COS.PEL. ref. SIMILAR ref. 1003.00010 1381564 / 1440113 / 1726851</p> <p style="text-align: right;">DX RH</p> <p>1003.00009 1381563 / 1440108</p> <p style="text-align: right;">SX LH</p>
	<p>CERNIERA GRIGLIA SUPERIORE METALLO UPPER GRILLE HINGE STEEL</p> <p>COS.PEL. ref. SIMILAR ref. 1003.00012 1366288 / 1383888 / 1393447</p> <p style="text-align: right;">DX RH</p> <p>1003.00011 1366287 / 1383887</p> <p style="text-align: right;">SX LH</p>
	<p>CERNIERA GRIGLIA INFERIORE METALLO LOWER GRILLE HINGE STEEL</p> <p>COS.PEL. ref. SIMILAR ref. 1003.00014 1381480</p> <p style="text-align: right;">DX RH</p> <p>1003.00013 1381479</p> <p style="text-align: right;">SX LH</p>

	<p>GRIGLIA PEDANA INFERIORE ALLUMINIO LOWER STEP PLATE ALUMINIUM</p> <p>COS.PEL. ref. SIMILAR ref. 1003.00015 1390076 / 1535049</p> <p style="text-align: right;">DX-SX RH-LH</p>
	<p>GRIGLIA PEDANA SUPERIORE ALLUMINIO UPPER STEP PLATE ALUMINIUM</p> <p>COS.PEL. ref. SIMILAR ref. 1003.00016 1351203 / 1535045</p> <p style="text-align: right;">DX-SX RH-LH</p>
	<p>SUPPORTO PARAFANGO POSTERIORE METALLO CON RINFORZO REAR MUDGUARD BRACKET STEEL</p> <p>COS.PEL. ref. SIMILAR ref. 1003.00020 (1523608 rinforzo) / 1400900 / 1457896 / 1725672 / 1742386</p> <p style="text-align: right;">DX RH</p> <p>1003.00019 (1523607 rinforzo) / 1400899 / 1457895 / 1725671 / 2054603</p> <p style="text-align: right;">SX LH</p>
	<p>COPRI BATTERIE P.P.G.F. - SENZA STAFFE BATTERY COVER P.P.G.F. - WITHOUT BRACKETS</p> <p>COS.PEL. ref. SIMILAR ref. 1003.00021 1482405 / 1785531 / 2093721</p>
	<p>COPRI BATTERIE P.P.G.F. - CON STAFFE BATTERY COVER P.P.G.F. - WITH BRACKETS</p> <p>COS.PEL. ref. SIMILAR ref. 1003.00022 1482404 / 1785530 / 2093720</p> <p style="text-align: right;">Tappo copribatteria 1003.00031</p>
	<p>SUPPORTO PARAFANGO POSTERIORE METALLO CON RINFORZO REAR MUDGUARD BRACKET METAL WITH REINFORCING</p> <p>COS.PEL. ref. SIMILAR ref. 1003.00024 (1523608 rinforzo) / 1358316 / 1457888 / 1725664 / 1742378 / 2054602 / 2057120</p> <p style="text-align: right;">DX RH</p> <p>1003.00023 (1523607 rinforzo) / 1358315 / 1457887 / 1725663 / 1742377 / 2054601 / 2057119</p> <p style="text-align: right;">SX LH</p>
	<p>SERRATURA GRIGLIA ANTERIORE LOCK GRILLE</p> <p>COS.PEL. ref. SIMILAR ref. 1003.00026 1440780</p> <p style="text-align: right;">DX RH</p> <p>1003.00025 1440781</p> <p style="text-align: right;">SX LH</p>
	<p>TAPPO COPRI BATTERIA NERO BATTERY COVER CAP BLACK</p> <p>COS.PEL. ref. SIMILAR ref. 1003.00031 1362691</p>

	<p>GRADINO COPERCHIO COPRIBATTERIE ALLUMINIO STEP COVER BATTERY ALUMINIUM</p> <p>COS.PEL. ref. SIMILAR ref. 1003.45054 1425051</p>
	<p>GRADINO COPERCHIO COPRIBATTERIE ALLUMINIO STEP COVER BATTERY ALUMINIUM</p> <p>COS.PEL. ref. SIMILAR ref. 1003.45055 1425052</p>
	<p>CORNICE FARO A.B.S. - NERO HEADLAMP FRAME A.B.S. - BLACK</p> <p>COS.PEL. ref. SIMILAR ref. 1103.24600 1324600 / 1543635 DX RH</p> <p>1103.24599 1324599 / 1543634 SX LH</p>
	<p>SUPPORTO FARO LAMP BRACKET</p> <p>COS.PEL. ref. SIMILAR ref. 1603.67004 1385403 DX RH</p> <p>1603.67003 1385402 SX LH</p>
	<p>FANALE LATERALE LED 4 LED - 12 / 24 Volt SIDE LAMP LED 4 LED - 12 / 24 Volt</p> <p>COS.PEL. ref. SIMILAR ref. 003006 1391144 / 1443884 / 1471599 DX-SX RH-LH</p> <p>ARANCIO / ORANGE (12/24 V)</p>
<p>AD ESAURIMENTO SCORTE UNTIL SPILL-OUT</p> 	<p>CATADIOTTRO MARKER WITH REFLEX-REFLECTOR</p> <p>COS.PEL. ref. SIMILAR ref. 1603.44707 1362707 / 2052117 DX-SX RH-LH</p>
	<p>CABLAGGIO ELETTRICO BULB HOLDER</p> <p>COS.PEL. ref. SIMILAR ref. 1603.85412 1732515</p>
 	<p>FANALINO P21W R5W BICOLORE CORNER LAMP P21W R5W DOUBLE COLOUR</p> <p>COS.PEL. ref. SIMILAR ref. 1603.87150 1349784 / 1387155 DX RH</p> <p>1603.85411 1349783 / 1385410 SX LH</p>

 	<p>FENDINEBBIA H1 H1 FOG LAMP H1 H1 COS.PEL. ref. SIMILAR ref. 1603.22992 1358832 / 1400208 / 1422992 / 1529071 DX RH</p> <p>1603.22991 1358831 / 1400207 / 1422991 / 1529070 SX LH</p>
 	<p>PROIETTORE H4 - PREDISPOSTO PER CORRETTORE ASSETTO HEADLAMP H4 - SUITABLE FOR LOAD LEVEL ADJUSTMENT COS.PEL. ref. SIMILAR ref. 1603.67002 1431256 / 1446588 / 1467003 / 1732510 DX RH</p> <p>1603.67001 1431257 / 1446587 / 1467000 / 1732509 SX LH</p>
	<p>MANIGLIA PORTA SENZA CHIAVE DOOR HANDLE WITHOUT KEY COS.PEL. ref. SIMILAR ref. 1703.30220 1423018 / 1488410 / 1544331 / 2005370 / 2145648 / 2371255 DX RH</p> <p>1703.30221 1423017 / 1488409 / 1544330 / 2005369 / 2145647 / 2371254 SX LH</p>
	<p>KIT BLOCCHETTI CON CHIAVI DOOR HANDLE LOCKS WITH KEYS COS.PEL. ref. SIMILAR ref. 1703.30222 1485072 / 581025</p>
	<p>ALZACRISTALLI MANUALE WINDOW REGULATOR MANUAL COS.PEL. ref. SIMILAR ref. 1903.45302 1366848 DX RH</p> <p>1903.45303 1366847 SX LH</p>
	<p>ALZACRISTALLI ELETTRICO - CON MOTORINO - 2 PIN WINDOW REGULATOR ELECTRIC - WITH MOTOR - 2 PIN COS.PEL. ref. SIMILAR ref. 1903.45304 1366850 / 1442295 DX RH</p> <p>1903.45305 1366849 / 1442294 SX LH</p>
	<p>VASCETTA ESPANSIONE EXPANSION TANK COS.PEL. ref. SIMILAR ref. 2103.44080 1370707 / 1385966 / 1421090 / 1511775 / 1765735 / 1855164 / 1894478</p>
	<p>TIRANTE PARAFANGO GOMMA - NERO MUDGUARD TENSIONER RUBBER - BLACK COS.PEL. ref. SIMILAR ref. 1003.00144 1383858</p>

	<p>CICALINO DI RETROMARCIA LC8 destra Cicalino di retromarcia - 24V - 90db BUZZER LC8 right buzzer - 24V - 90db</p> <p>COS.PEL. ref. SIMILAR ref. 003092 -</p>
	<p>KIT PER CONNESSIONI ELETTRICHE Connettore AMP 1,5 singolo KIT FOR ELECTRICAL JOINTS Connector AMP 1,5 simple</p> <p>COS.PEL. ref. SIMILAR ref. 003120 -</p>
	<p>KIT PER CONNESSIONI ELETTRICHE Connettore SUPERSEAL 2 vie femmina KIT FOR ELECTRICAL JOINTS Connector SUPERSEAL ways female</p> <p>COS.PEL. ref. SIMILAR ref. 003123 -</p> <p>Connettore per la serie 1500.xxxxx</p>
 <p>cm 15,3</p>	<p>FANALE POSTERIORE 7 FUNZIONI REAR-LIGHT 7 FUNCTIONS</p> <p>COS.PEL. ref. SIMILAR ref. 005720 1504609 DX RH</p> <p>005730 1504608 SX LH Con luce targa / With plate light</p> <p>TRASPARENTE / LENS 011211 1380819 DX-SX RH-LH</p>
 <p>cm 15,3</p>	<p>FANALE POSTERIORE REAR-LIGHT</p> <p>COS.PEL. ref. SIMILAR ref. 005726 1508184 DX RH</p> <p>005725 1508182 SX LH Con luce targa / With plate light</p> <p>TRASPARENTE / LENS 011214 1412392 DX-SX RH-LH</p>
 <p>15,2 cm</p>	<p>FANALE POSTERIORE LED - 24V - CONNETTORE POSTERIORE AMP 1.5 REAR-LIGHT LED - 24V - REAR CONNECTOR AMP 1.5</p> <p>COS.PEL. ref. SIMILAR ref. 1500.00000 - DX RH</p> <p>1500.00001 - Relativo connettore multipolare 003120 SX LH</p> <p>TRASPARENTE / LENS - Relativo connettore multipolare 003120</p>
 <p>cm 15,1</p>	<p>FANALE POSTERIORE LED - 24V - CONNETTORE POSTERIORE AMP 1.5 REAR-LIGHT LED - 24V - REAR CONNECTOR AMP 1.5</p> <p>COS.PEL. ref. SIMILAR ref. 1503.45000 - DX RH</p> <p>1503.45001 - Relativo connettore 003120 SX LH</p> <p>TRASPARENTE / LENS 1503.45100 - DX RH</p> <p>1503.45101 - SX LH</p>
 <p>cm 15,1</p>	<p>FANALE POSTERIORE LED - 24V - CONNETTORE LATERALE AMP 1.5 REAR-LIGHT LED - 24V - LATERAL CONNECTOR AMP 1.5</p> <p>COS.PEL. ref. SIMILAR ref. 1503.45002 - DX RH</p> <p>1503.45003 - Relativo connettore 003120 SX LH</p> <p>TRASPARENTE / LENS 1503.45100 - DX RH</p> <p>1503.45101 - SX LH</p>









CR 114-124-144-164

	<p>FANALE POSTERIORE REAR-LIGHT LED - 24V - CONNETTORE LATERALE AMP 1.5 LED - 24V - LATERAL CONNECTOR AMP 1.5</p> <p>COS.PEL. ref. SIMILAR ref. 1503.45005 - SX LH Con luce targa / With plate light - Relativo connettore 003120</p> <p>TRASPARENTE / LENS 1503.45101 - SX LH</p>
	<p>FANALE POSTERIORE REAR-LIGHT CONNETTORE LATERALE AMP 1.5 LATERAL CONNECTOR AMP 1.5</p> <p>COS.PEL. ref. SIMILAR ref. 1503.45006 1756751 / 2021575 / 2129987 DX RH (ex 005722) - Relativo connettore 003120 1503.45007 1756754 / 2021579 / 2129985 SX LH Con luce targa / With plate light (ex 005721) - Connettore 003120</p> <p>TRASPARENTE / LENS 1503.45102 1784670 / 2129991 ex 011212/009212 DX RH 1503.45103 1784669 / 2129992 ex 011213/009213 SX LH</p>
	<p>FANALE POSTERIORE REAR-LIGHT CONNETTORE LATERALE AMP 1.5 LATERAL CONNECTOR AMP 1.5</p> <p>COS.PEL. ref. SIMILAR ref. 1503.45008 1791369 / 2021576 / 2129988 DX RH Con cicalino / With buzzer (ex 005724) - Connettore 003120 1503.45009 2021578 / 2129986 SX LH Senza luce targa / W-O Plate light - Connettore 003120</p> <p>TRASPARENTE / LENS 1503.45102 1784670 / 2129991 ex 011212/009212 DX RH 1503.45103 1784669 / 2129992 ex 011213/009213 SX LH</p>

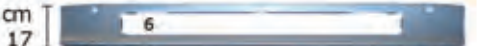

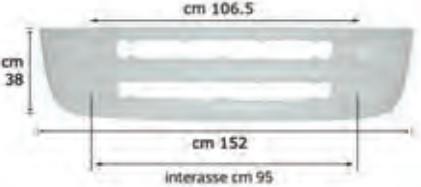
	<p>GRIGLIA SUPERIORE METALLO - BIANCO UPPER GRILLE STEEL - WHITE</p> <p>COS.PEL. ref. SIMILAR ref. 103.45145 1538383 / 1755594 / 1880736</p>
	<p>GRIGLIA SUPERIORE METALLO UPPER GRILLE STEEL</p> <p>COS.PEL. ref. SIMILAR ref. 103.45142 1459133</p>
	<p>GRIGLIA SUPERIORE METALLO UPPER GRILLE STEEL</p> <p>COS.PEL. ref. SIMILAR ref. 103.45143 1459134 / 1880737</p>
	<p>GRIGLIA INFERIORE METALLO LOWER GRILLE STEEL</p> <p>COS.PEL. ref. SIMILAR ref. 103.45144 1459135</p>
	<p>GRIGLIA PRESA ARIA SUPERIORE METALLO UPPER GRILLE STEEL</p> <p>COS.PEL. ref. SIMILAR ref. 103.45140 1466032 DX RH</p> <p>103.45141 1466031 SX LH</p>

CR - R

	<p>GRIGLIA CENTRALE METALLO CENTRAL GRILLE STEEL</p> <p>COS.PEL. ref. 103.43101 SIMILAR ref. 1743177 / 1748086</p>
	<p>GRIGLIA CENTRALE CENTRAL GRILLE</p> <p>COS.PEL. ref. 103.45152 SIMILAR ref. 1459146</p>
	<p>GRIGLIA CENTRALE METALLO CENTRAL GRILLE STEEL</p> <p>COS.PEL. ref. 103.45139 SIMILAR ref. 1459488 / 1743176 / 1748085</p>
	<p>GRIGLIA CENTRALE METALLO CENTRAL GRILLE STEEL</p> <p>COS.PEL. ref. 103.45150 SIMILAR ref. 1459145</p>
	<p>GRIGLIA INFERIORE PC + ABS - BIANCO LOWER GRILLE PC + ABS - WHITE</p> <p>COS.PEL. ref. 103.45146 SIMILAR ref. 1536807</p>
	<p>GRIGLIA SUPERIORE CALANDRA INFERIORE METALLO UPPER GRILLE STEEL</p> <p>COS.PEL. ref. 103.45147 SIMILAR ref. 1459141</p>
	<p>GRIGLIA INFERIORE CALANDRA INFERIORE METALLO LOWER GRILLE STEEL</p> <p>COS.PEL. ref. 103.45148 SIMILAR ref. 1459142</p>
	<p>KIT GOMMINI ADESIVI ANTISCIVOLO KIT RUBBER FOR GRILLE</p> <p>COS.PEL. ref. 103.45149 SIMILAR ref. 1514524_5_6+1726328</p>

	<p>SUPPORTO FRONTALE ALLUMINIO FRONTAL SOPPORT ALUMINIUM</p> <p>COS.PEL. ref. SIMILAR ref. 103.45151 1451246 / 1721731 / 1746585 / 1804628</p>
	<p>GRIGLIA INFERIORE LOWER GRILLE</p> <p>COS.PEL. ref. SIMILAR ref. 103.46142 1871667</p>
	<p>STAFFA PER GRIGLIA SUPERIORE UPPER GRILLE PLUG</p> <p>COS.PEL. ref. SIMILAR ref. 103.46144 1451528 DX RH</p> <p>103.46143 1451527 SX LH</p>
	<p>COPRI CERNIERA FRONT PANEL COVER</p> <p>COS.PEL. ref. SIMILAR ref. 103.46166 1479759 DX RH</p> <p>103.46165 1479758 SX LH</p>
	<p>RIVESTIMENTO PARAFANGO LATERALE PARTE POST A.B.S. - GRIGIO LATERAL MUDGUARD A.B.S. - GREY</p> <p>COS.PEL. ref. SIMILAR ref. 203.45202 1431934 DX RH</p> <p>203.45201 1431933 SX LH</p>
	<p>PROFILO PARAFANGO LATERALE A.B.S. - GRIGIO LATERAL MUDGUARD A.B.S. - GREY</p> <p>COS.PEL. ref. SIMILAR ref. 203.45204 1431932 DX RH</p> <p>203.45203 1431931 SX LH</p>
	<p>PARASPRUZZI ANTISPRAY</p> <p>COS.PEL. ref. SIMILAR ref. 203.45206 1947568 DX RH</p> <p>203.45205 1947569 SX LH</p>
	<p>COPERCHIO PARAFANGO A.B.S. - GRIGIO COVER MUDGUARD A.B.S. - GREY</p> <p>COS.PEL. ref. SIMILAR ref. 203.68652 1368652 / 2026619 / 2026621 DX RH</p> <p>203.68651 1362708 / 2026618 / 2026620 SX LH</p>

ALL ITEMS MENTIONED IN OUR CATALOGUE ARE NOT ORIGINAL PARTS BUT PERFECTLY INTERCHANGEABLE WITH THEM.

GOVERNING LEGISLATIONS FOR THE SALE OF OUR PRODUCTS DIFFER IN EACH COUNTRY.

INFRINGEMENTS, IF ANY, OF LOCAL LEGISLATIONS ARE RESPONSIBILITY OF THE RETAILER IN THE COUNTRY OF FINAL DISTRIBUTION.



CR - R

	<p>MEZZO PARAFANGO POSTERIORE SX ANTERIORE DX P.P.T. - GRIGIO REAR MUDGUARD LH FRONT RH P.P.T. - GREY</p> <p>COS.PEL. ref. SIMILAR ref. 203.44599 1357599</p> <p style="text-align: right;">SX LH</p>
	<p>MEZZO PARAFANGO POSTERIORE DX ANTERIORE SX P.P.T. - GRIGIO REAR MUDGUARD RH FRONT LH P.P.T. - GREY</p> <p>COS.PEL. ref. SIMILAR ref. 203.44600 1357600</p> <p style="text-align: right;">DX RH</p>
	<p>CALOTTA PARAF. POST. RIBASSATA CON 4 TIRANTI P.P.T. - GRIGIO REAR MUDGUARD FLAT TYPE WITH 4 MUDG. TENS. P.P.T. - GREY</p> <p>COS.PEL. ref. SIMILAR ref. 203.57601 1357602 / 1383858</p> <p style="text-align: right;">DX-SX RH-LH</p> <p>(203.57602 versione senza i tiranti)</p>
	<p>CALOTTA PARAFANGO POSTERIORE RIBASSATA P.P.T. - GRIGIO REAR MUDGUARD FLAT TYPE P.P.T. - GREY</p> <p>COS.PEL. ref. SIMILAR ref. 203.57602 1357602</p> <p style="text-align: right;">DX-SX RH-LH</p> <p>Relativo tirante 1003.00144 - (203.57601 versione con i tiranti)</p>
	<p>CALOTTA PARAF. POST. INTERM. CON 4 TIRANTI P.P.T. - GRIGIO REAR MUDGUARD WITH 4 MUDGUARD TENSIONERS P.P.T. - GREY</p> <p>COS.PEL. ref. SIMILAR ref. 203.95275 1383858 / 1395276</p> <p style="text-align: right;">DX-SX RH-LH</p> <p>(203.95276 versione senza i tiranti)</p>
	<p>CALOTTA PARAFANGO POSTERIORE INTERMEDIO P.P.T. - GRIGIO REAR MUDGUARD STANDARD P.P.T. - GREY</p> <p>COS.PEL. ref. SIMILAR ref. 203.95276 1395276</p> <p style="text-align: right;">DX-SX RH-LH</p> <p>Relativo tirante 1003.00144 - (203.95275 versione con i tiranti)</p>
	<p>CALOTTA PARAFANGO POSTERIORE ALTA P.P.T. - GRIGIO HIGH REAR MUDGUARD P.P.T. - GREY</p> <p>COS.PEL. ref. SIMILAR ref. 203.95277 1357601</p> <p style="text-align: right;">DX-SX RH-LH</p> <p>Relativo tirante 1003.00144 - (203.95278 versione con i tiranti)</p>
	<p>CALOTTA PARAFANGO POST. ALTA CON 4 TIRANTI P.P.T. - GRIGIO HIGH REAR MUDGUARD RH-LH W/TENSIONERS P.P.T. - GREY</p> <p>COS.PEL. ref. SIMILAR ref. 203.95278 1357601 / 1383858</p> <p style="text-align: right;">DX-SX RH-LH</p> <p>203.95277 : versione senza i tiranti</p>









 <p>cm 47 cm 17.5</p>	<p>COPERCHIO PEDANA CENTRALE P.C.+P.B.T. - GRIGIO COVER CENTRE FOOTSTEP P.C.+P.B.T. - GREY COS.PEL. ref. SIMILAR ref. 303.45240 1486648 / 1779121</p> <p>303.45241 1486647 / 1779120</p> <p style="text-align: right;">DX RH</p> <p style="text-align: right;">SX LH</p>
	<p>COPERCHIO PEDANA INFERIORE P.C.+P.B.T. - GRIGIO LOWER COVER FOOTSTEP P.C.+P.B.T. - GREY COS.PEL. ref. SIMILAR ref. 303.45242 1512424</p> <p>303.45243 1512423</p> <p style="text-align: right;">DX RH</p> <p style="text-align: right;">SX LH</p>
	<p>COPERCHIO PEDANA SUPERIORE P.C.+P.B.T. - GRIGIO UPPER COVER FOOTSTEP P.C.+P.B.T. - GREY COS.PEL. ref. SIMILAR ref. 303.45244 1442654</p> <p>303.45245 1442653</p> <p style="text-align: right;">DX RH</p> <p style="text-align: right;">SX LH</p>
	<p>PROTEZIONE PEDANA SUPERIORE A.B.S. - GRIGIO UPPER FOOTSTEP PROTECTION A.B.S. - GREY COS.PEL. ref. SIMILAR ref. 303.45246 1529886</p> <p>303.45247 1732322</p> <p style="text-align: right;">DX RH</p> <p style="text-align: right;">SX LH</p>
	<p>PARETE PEDANA METALLO LATERAL MUDGUARD STEEL COS.PEL. ref. SIMILAR ref. 303.45248 1498180 / 1854228</p> <p>303.45249 1498179 / 1854227</p> <p style="text-align: right;">DX RH</p> <p style="text-align: right;">SX LH</p>
	<p>COPERCHIO PEDANA STEP PANEL CENTRAL COVER COS.PEL. ref. SIMILAR ref. 303.45250 1501343 / 1779119</p> <p>303.45251 1501342 / 1779118</p> <p style="text-align: right;">DX RH</p> <p style="text-align: right;">SX LH</p>
 <p>cm 112 cm 38.5</p>	<p>PARAURTI CENTRALE SENZA GRIGLIA - P.C.+A.B.S. - GRIGIO CENTRE BUMPER W/O GRILLE - P.C.+A.B.S. - GREY COS.PEL. ref. SIMILAR ref. 403.45129 1431924</p>
 <p>cm 112 cm 38.5</p>	<p>PARAURTI CENTRALE CON GRIGLIA - P.C.+A.B.S. - GRIGIO FRONT BUMPER WITH GRILLE - P.C.+A.B.S. - GREY COS.PEL. ref. SIMILAR ref. 403.45130 1504131</p> <p style="text-align: right;">Composto da 403.45127 + 403.45128 + 403.45129</p>

CR - R

	<p>ANGOLO PARAURTI P.C.+A.B.S. - GRIGIO CORNER BUMPER P.C.+A.B.S. - GREY COS.PEL. ref. SIMILAR ref. 403.45132 1431926 / 1853347</p> <p>403.45131 1431925 / 1853346</p> <p style="text-align: right;">DX RH</p> <p style="text-align: right;">SX LH</p>
	<p>ANGOLO PARAURTI P.C.+A.B.S. - GRIGIO CORNER BUMPER P.C.+A.B.S. - GREY COS.PEL. ref. SIMILAR ref. 403.45134 1439789</p> <p>403.45133 1439788</p> <p style="text-align: right;">DX RH</p> <p style="text-align: right;">SX LH</p>
	<p>SUPPORTO PARAURTI METALLO SUPPORT BUMPER STEEL COS.PEL. ref. SIMILAR ref. 403.45137 1422843 / 1731206 / 1763296</p>
	<p>GRIGLIA PARAURTI METALLO BUMPER GRILLE STEEL COS.PEL. ref. SIMILAR ref. 403.45128 1495578</p> <p>403.45127 1495577</p> <p style="text-align: right;">DX RH</p> <p style="text-align: right;">SX LH</p>
	<p>TAPPO PARAURTI COPRIFENDINEBBIA INTERNO P.C.+A.B.S. - GRIGIO INNER FOGLAMP COVER BUMPER P.C.+A.B.S. - GREY COS.PEL. ref. SIMILAR ref. 403.45135 1523508</p> <p style="text-align: right;">DX-SX RH-LH</p>
	<p>TAPPO PARAURTI COPRIFENDINEBBIA ESTERNO P.C.+A.B.S. - GRIGIO OUTER FOGLAMP COVER BUMPER P.C.+A.B.S. - GREY COS.PEL. ref. SIMILAR ref. 403.45136 1523509</p> <p style="text-align: right;">DX-SX RH-LH</p>
	<p>VETRO SPECCHIO RISCALDATO - (432x220mm) MIRROR GLASS HEATED - (432x220mm) COS.PEL. ref. SIMILAR ref. 503.44001 1442705 / 1732776 / 1765985</p> <p style="text-align: right;">DX-SX RH-LH</p>
	<p>VETRO SPECCHIO GRANDANGOLO - RISCALDATO - (184x160mm) - RAGGIO 300 MIRROR GLASS WIDE ANGLE - HEATED - (184x160mm) - RADIUS 300 COS.PEL. ref. SIMILAR ref. 503.44002 1443864 / 1732778 / 1767265</p> <p style="text-align: right;">DX RH</p>

<p>AD ESAURIMENTO SCORTE UNTIL SPILL-OUT</p> 	<p>SPECCHIO RETROVISORE GRANDANGOLO - RISCALDATO (2500mm) REAR-VIEW MIRROR WIDE ANGLE - HEATED (2500mm) COS.PEL. ref. SIMILAR ref. 503.44004 - DX RH</p> <p>503.44003 - SX LH Largo / Large - Stretto / Narrow</p>
	<p>SPECCHIO RETROVISORE G.A. ELETTRICO - RISCALDATO (2500mm) REAR-VIEW MIRROR WIDE ANGLE - ELECTRIC - HEATED (2500mm) COS.PEL. ref. SIMILAR ref. 503.44006 - DX RH</p> <p>503.44005 - SX LH Largo / Large - Stretto / Narrow</p>
<p>AD ESAURIMENTO SCORTE UNTIL SPILL-OUT</p> 	<p>SPECCHIO RETROVISORE RISCALDATO (2500mm) REAR-VIEW MIRROR HEATED (2500mm) COS.PEL. ref. SIMILAR ref. 503.44008 - DX RH</p> <p>503.44007 - SX LH Largo / Large - Stretto / Narrow</p>
<p>AD ESAURIMENTO SCORTE UNTIL SPILL-OUT</p> 	<p>SPECCHIO RETROVISORE ELETTRICO - RISCALDATO (BRACCIO 2500mm) REAR-VIEW MIRROR ELECTRIC - HEATED (BRACCIO 2500mm) COS.PEL. ref. SIMILAR ref. 503.44010 1406634 DX RH</p> <p>503.44009 1406627 SX LH Largo / Large - Stretto / Narrow</p>
	<p>SPECCHIO RETROVISORE GRANDANGOLO - RISCALDATO REAR-VIEW MIRROR WIDE ANGLE - HEATED COS.PEL. ref. SIMILAR ref. 503.44012 1732783 / 1765808 DX RH</p> <p>503.44011 1732782 / 1765809 SX LH</p>
	<p>COPERCHIO RETROVISORE A.B.S. - NERO - CON FORO PER GRANDANGOLO MIRROR COVER A.B.S. - BLACK - WITH AUXILIARY MIRROR COS.PEL. ref. SIMILAR ref. 503.44014 1396542 DX RH</p> <p>503.44013 1945731 SX LH Largo / Large - Supporti/Brackets : 503.45012 - Stretto / Narrow - Supporti/Brackets : 503.45013</p>
	<p>TAPPO A.B.S. - GRIGIO COVER A.B.S. - GREY COS.PEL. ref. SIMILAR ref. 503.44016 1346684 DX RH</p> <p>503.44015 1346683 SX LH</p>
	<p>COPERCHIO RETROVISORE SENZA FORO A.B.S. - SENZA FORO PER GRANDANGOLO COVER MIRROR W/O AUXILIARY MIRROR A.B.S. - W/O AUXILIARY MIRROR COS.PEL. ref. SIMILAR ref. 503.44018 1406628 DX RH</p> <p>503.44017 1366141 SX LH</p>

CR - R

<p>AD ESAURIMENTO SCORTE UNITS SHAL-OUT</p> 	<p>SPECCHIO RETROVISORE GRANDANGOLO - RISCALDATO (2600mm) REAR-VIEW MIRROR WIDE ANGLE - HEATED (2600mm) COS.PEL. ref. SIMILAR ref. 503.45004 - DX RH</p> <p>503.45003 Largo / Large - SX LH</p> <p>Stretto / Narrow</p>
	<p>SPECCHIO RETROVISORE ELETTRICO - RISCALDATO (BRACCIO 2600mm) REAR-VIEW MIRROR ELECTRIC - HEATED (ARM 2600mm) COS.PEL. ref. SIMILAR ref. 503.45006 - DX RH</p> <p>503.45005 Largo / Large - SX LH</p> <p>Stretto / Narrow</p>
	<p>SPECCHIO RETROVISORE RISCALDATO (2600mm) REAR-VIEW MIRROR HEATED (2600mm) COS.PEL. ref. SIMILAR ref. 503.45008 - DX RH</p> <p>503.45007 Largo / Large - SX LH</p> <p>Stretto - Senza foro g.angolo / Narrow</p>
	<p>SPECCHIO RETROVISORE ELETTRICO - RISCALDATO (2600mm) REAR-VIEW MIRROR ELECTRIC - HEATED (2600mm) COS.PEL. ref. SIMILAR ref. 503.45010 1723519 DX RH</p> <p>503.45009 Largo / Large 1723518 SX LH</p> <p>Stretto - Senza foro g.angolo / Narrow</p>
	<p>COPRIBRACCIO INFERIORE METALLO LOWER ARM COVER STEEL COS.PEL. ref. SIMILAR ref. 503.45011 1346380 DX-SX RH-LH</p>
	<p>SUPPORTO VETRO METALLO GLASS FIXING STEEL COS.PEL. ref. SIMILAR ref. 503.45012 1396530 DX RH</p> <p>503.45013 Largo / Large 1396529 SX LH</p> <p>Stretto / Narrow</p>
	<p>SPECCHIO GUARDARUOTA RAGGIO 300 ROOF MIRROR RADIUS 300 COS.PEL. ref. SIMILAR ref. 503.45014 1484080</p>
	<p>SPECCHIO FRONTALE FRONT MIRROR COS.PEL. ref. SIMILAR ref. 503.45015 1484076</p>

	<p>BRACCIO SPECCHIO FRONTALE TETTO ALTO TETTO ALTO ARM FRONT MIRROR HIGH CAB HIGH CAB</p> <p>COS.PEL. ref. SIMILAR ref. 503.45016 1484079</p>
	<p>BRACCIO SPECCHIO FRONTALE TETTO MEDIO TETTO MEDIO ARM FRONT MIRROR MEDIUM CAB MEDIUM CAB</p> <p>COS.PEL. ref. SIMILAR ref. 503.45017 1484078</p>
	<p>VISIERA PARASOLE INFERIORE LOWER SUN VISOR</p> <p>COS.PEL. ref. SIMILAR ref. 703.45500 1355655</p>
	<p>VISIERA PARASOLE SUPERIORE TETTO MEDIO CON FORI FENDI SUN VISOR WITH HOLES WITH HOLES</p> <p>COS.PEL. ref. SIMILAR ref. 703.45501 1539870</p>
	<p>VISIERA PARASOLE SUPERIORE SENZA FORI FENDI SENZA FORI FENDI SUN VISOR WITHOUT HOLES WITHOUT HOLES</p> <p>COS.PEL. ref. SIMILAR ref. 703.45502 1539871</p>
	<p>VISIERA PARASOLE SUN VISOR</p> <p>COS.PEL. ref. SIMILAR ref. 703.45503 -</p>
	<p>CONVOGLIATORE ARIA INTERNO A.B.S. - GRIGIO INNER CORNER PANEL A.B.S. - GREY</p> <p>COS.PEL. ref. SIMILAR ref. 903.45228 1495957 / 1749717 / 1798864 / 1856474 DX RH</p> <p>903.45229 1495956 / 1749716 / 1798863 / 1856475 SX LH</p>
	<p>CONVOGLIATORE ARIA P.C.+A.B.S. - BIANCO AIR CONVEYOR P.C.+A.B.S. - WHITE</p> <p>COS.PEL. ref. SIMILAR ref. 903.45230 1538385 / 1751406 DX RH</p> <p>903.45231 1538384 / 1751405 SX LH</p>

CR - R

	<p>SUPPORTO TIRANTE PARAFANGO POSTERIORE METALLO REAR MUDGUARD TENSIONER STEEL</p> <p>COS.PEL. ref. SIMILAR ref. 1003.00007 1383520</p>
	<p>GRIGLIA PEDANA SUPERIORE ALLUMINIO UPPER STEP PLATE ALUMINIUM</p> <p>COS.PEL. ref. SIMILAR ref. 1003.45048 1535048 / 1805447</p> <p style="text-align: right;">DX-SX RH-LH</p>
	<p>GRIGLIA PEDANA INFERIORE ALLUMINIO LOWER STEP PLATE ALUMINIUM</p> <p>COS.PEL. ref. SIMILAR ref. 1003.45049 1535052</p> <p style="text-align: right;">DX-SX RH-LH</p>
	<p>GRIGLIA PEDANA SUPERIORE ALLUMINIO UPPER STEP PLATE ALUMINIUM</p> <p>COS.PEL. ref. SIMILAR ref. 1003.45050 1535040</p> <p style="text-align: right;">DX RH</p> <p>1003.45051 1535039</p> <p style="text-align: right;">SX LH</p>
	<p>SUPPORTO FENDINEBBIA P.P.G.F. FOG LAMP BRACKET P.P.G.F.</p> <p>COS.PEL. ref. SIMILAR ref. 1003.45052 1523882 / 1786693</p> <p style="text-align: right;">DX RH</p> <p>1003.45053 1523881 / 1786692</p> <p style="text-align: right;">SX LH</p>
	<p>SUPPORTO PARAFANGO POSTERIORE PARTE POSTERIORE - METALLO REAR MUDGUARD BRACKET REAR PART - STEEL</p> <p>COS.PEL. ref. SIMILAR ref. 1003.45056 1721894 / 2054580</p> <p style="text-align: right;">DX RH</p> <p>1003.45057 1721893 / 2054579</p> <p style="text-align: right;">SX LH</p>
	<p>SUPPORTO PARAFANGO POSTERIORE PARTE ANTERIORE - METALLO REAR MUDGUARD BRACKET FRONT PART - STEEL</p> <p>COS.PEL. ref. SIMILAR ref. 1003.45058 1721892 / 1927258 / 2054582</p> <p style="text-align: right;">DX RH</p> <p>1003.45059 1721891 / 1927257 / 2054581</p> <p style="text-align: right;">SX LH</p>
	<p>CERNIERA GRIGLIA INFERIORE PARAURTI ALTO PROTECTOR BRACKET</p> <p>COS.PEL. ref. SIMILAR ref. 1003.46102 1889300</p> <p style="text-align: right;">DX RH</p> <p>1003.46103 1889299</p> <p style="text-align: right;">SX LH</p>

	<p>SUPPORTO PARAFANGO POSTERIORE PARTE ANTERIORE - METALLO REAR MUDGUARD BRACKET FRONT PART - STEEL COS.PEL. ref. SIMILAR ref. 1003.46232 1927262 / 2054586 DX RH</p> <p>1003.46233 1927261 / 2054585 SX LH</p>
	<p>SUPPORTO PARAFANGO POSTERIORE PARTE ANTERIORE - METALLO REAR MUDGUARD BRACKET FRONT PART - STEEL COS.PEL. ref. SIMILAR ref. 1003.46234 1927260 / 2054584 DX RH</p> <p>1003.46235 1927259 / 2054583 SX LH</p>
	<p>SUPPORTO PARAFANGO POSTERIORE PARTE ANTERIORE - METALLO REAR MUDGUARD BRACKET FRONT PART - STEEL COS.PEL. ref. SIMILAR ref. 1003.46236 1725676 DX RH</p> <p>1003.46237 1725675 SX LH</p>
	<p>COPRI BATTERIA 220/225 AH BATTERY COVER 220/225 AH COS.PEL. ref. SIMILAR ref. 1003.46803 2196771</p> <p>Tirante / Tensioner : 1003.46805</p>
	<p>COPRI BATTERIA 140/180 AH BATTERY COVER 140/180 AH COS.PEL. ref. SIMILAR ref. 1003.46804 2182273</p> <p>Tirante / Tensioner : 1003.46805</p>
	<p>MOLLETTA CLIP COS.PEL. ref. SIMILAR ref. 103.45153 1541484</p>
	<p>PORTA FARO P.C. + P.B.T. - GRIGIO LIGHT HOUSING P.C. + P.B.T. - GREY COS.PEL. ref. SIMILAR ref. 1103.45530 1431921 / 1790007 / 1936675 DX RH</p> <p>1103.45531 1431920 / 1790006 / 1936674 SX LH</p>
	<p>PROFILO PORTA FARO P.C. + P.B.T. - GRIGIO PLASTIC HEADLIGHT BEZEL P.C. + P.B.T. - GREY COS.PEL. ref. SIMILAR ref. 1103.45532 1431923 DX RH</p> <p>1103.45533 1431922 / 2124015 SX LH</p>









CR - R

	<p>FISSAGGIO PORTA FARO METALLO BRACKET HEADLIGHT STEEL</p> <p>COS.PEL. ref. SIMILAR ref. 1103.45534 1438558 / 1727992</p> <p>1103.45535 1438557 / 1727991</p> <p style="text-align: right;">DX RH</p> <p style="text-align: right;">SX LH</p>
	<p>FANALE LATERALE 3 LED DX-SX 3 LED - 12 / 24 Volt SIDE MARKER 3 LED 3 LED - 12 / 24 Volt</p> <p>COS.PEL. ref. SIMILAR ref. 002999 1737413 / 2000390 / 2080828</p> <p style="text-align: right;">DX-SX RH-LH</p> <p style="text-align: right;">ARANCIO / ORANGE (12/24 V)</p>
<p>AD ESAURIMENTO SCORTE UNTIL BULB-OUT</p> 	<p>CATADIOTTRO MARKER WITH REFLEX-REFLECTOR</p> <p>COS.PEL. ref. SIMILAR ref. 1603.44707 1362707 / 2052117</p> <p style="text-align: right;">DX-SX RH-LH</p>
 	<p>FRECCIA P21W LED SIDE LAMP P21W LED</p> <p>COS.PEL. ref. SIMILAR ref. 1603.45524 1747981 / 2442689</p> <p style="text-align: right;">DX-SX RH-LH</p>
 	<p>FANALINO LATERALE P21W CORNER LAMP P21W</p> <p>COS.PEL. ref. SIMILAR ref. 1603.45525 1770301 / 2052103</p> <p style="text-align: right;">DX-SX RH-LH</p>
	<p>FANALINO VISIERA LED 4 LED VISOR LAMP LED 4 LED</p> <p>COS.PEL. ref. SIMILAR ref. 1603.45526 1798980 / 1910437</p>
 	<p>FRECCIA LED LED - P21W 24V - BASE CROMATA LED SIDE LAMP LED - P21W 24V - CHROME BASE</p> <p>COS.PEL. ref. SIMILAR ref. 1603.45531 1949900</p> <p style="text-align: right;">DX-SX RH-LH</p>
 	<p>LUCE DI POSIZIONE LED LED DAYTIME LIGHT LED LED</p> <p>COS.PEL. ref. SIMILAR ref. 1603.45532 1931614 / 2031055 / 2127432</p> <p>1603.45533 1931613 / 2031054 / 2127431</p> <p style="text-align: right;">DX RH</p> <p style="text-align: right;">SX LH</p>

 	<p>FRECCIA LED LED - BASE NERA LED SIDE LAMP LED - BLACK BASE</p> <p>COS.PEL. ref. SIMILAR ref. 1603.45534 2241544 / 2442637</p> <p style="text-align: right;">DX-SX RH-LH</p>
 	<p>FANALINO LATERALE 24V CORNER LAMP 24V</p> <p>COS.PEL. ref. SIMILAR ref. 1603.45535 1928063 / 2083830</p> <p style="text-align: right;">DX-SX RH-LH</p>
 	<p>PROIETTORE LUCE PROFONDITA' PARTE INTERNA - H1 HEADLAMP INTERNAL SIDE - H1</p> <p>COS.PEL. ref. SIMILAR ref. 1603.45520 1446354 / 1852570 / 2248114</p> <p>1603.45521 1446353 / 1852569 / 2248103</p> <p style="text-align: right;">DX RH SX LH</p>
 	<p>PROIETTORE FENDINEBBIA PARTE ESTERNA - H1 FOG LAMP EXTERNAL SIDE - H1</p> <p>COS.PEL. ref. SIMILAR ref. 1603.45522 1446356 / 1852573 / 2080689</p> <p>1603.45523 1446355 / 1852572 / 2080688</p> <p style="text-align: right;">DX RH SX LH</p>
 	<p>PROIETTORE XENON SENZA CENTRALINA H7 D2R T4W(24V) - SENZA CENTRALINA HEADLAMP XENON W/O CONTROL UNIT H7 D2R T4W(24V) - WITHOUT CENTRAL UNIT</p> <p>COS.PEL. ref. SIMILAR ref. 1603.45528 1760554 / 1892324 / 1900351 / 2442631</p> <p>1603.45527 1760551 / 1892322 / 1900349 / 2442629</p> <p style="text-align: right;">DX RH SX LH</p>
 	<p>VETRO PROIETTORE HEADLAMP GLASS</p> <p>COS.PEL. ref. SIMILAR ref. 1603.45530 1549815</p> <p>1603.45529 1549814</p> <p style="text-align: right;">DX RH SX LH</p>
	<p>MANIGLIA PORTA SENZA CHIAVE DOOR HANDLE WITHOUT KEY</p> <p>COS.PEL. ref. SIMILAR ref. 1703.30220 1423018 / 1488410 / 1544331 / 2005370 / 2145648 / 2371255</p> <p>1703.30221 1423017 / 1488409 / 1544330 / 2005369 / 2145647 / 2371254</p> <p style="text-align: right;">DX RH SX LH</p>
	<p>KIT BLOCCHETTI CON CHIAVI DOOR HANDLE LOCKS WITH KEYS</p> <p>COS.PEL. ref. SIMILAR ref. 1703.30222 1485072 / 581025</p>

CR - R

	<p>CERNIERA GRIGLIA CABINA ALTA HOOD LATCH HIGH CAB COS.PEL. ref. SIMILAR ref. 1703.30228 1902356</p> <p>1703.30227 1902355</p> <p style="text-align: right;">DX RH</p> <p style="text-align: right;">SX LH</p>
	<p>SERRATURA PORTA CENTRALIZZATA DOOR LOCK COS.PEL. ref. SIMILAR ref. 1703.30234 1789318 / 1867659</p> <p>1703.30233 1789317 / 1867658</p> <p style="text-align: right;">DX RH</p> <p style="text-align: right;">SX LH</p>
	<p>ALZACRISTALLI SENZA MOTORINO WINDOW REGULATOR WITHOUT MOTOR COS.PEL. ref. SIMILAR ref. 1903.45300 -</p> <p>1903.45301 -</p> <p style="text-align: right;">DX RH</p> <p style="text-align: right;">SX LH</p>
	<p>ALZACRISTALLI MANUALE WINDOW REGULATOR MANUAL COS.PEL. ref. SIMILAR ref. 1903.45302 1366848</p> <p>1903.45303 1366847</p> <p style="text-align: right;">DX RH</p> <p style="text-align: right;">SX LH</p>
	<p>ALZACRISTALLI ELETTRICO - CON MOTORINO - 2 PIN WINDOW REGULATOR ELECTRIC - WITH MOTOR - 2 PIN COS.PEL. ref. SIMILAR ref. 1903.45304 1366850 / 1442295</p> <p>1903.45305 1366849 / 1442294</p> <p style="text-align: right;">DX RH</p> <p style="text-align: right;">SX LH</p>
	<p>TIRANTE PARAFANGO GOMMA - NERO MUDGUARD TENSIONER RUBBER - BLACK COS.PEL. ref. SIMILAR ref. 1003.00144 1383858</p>
	<p>TIRANTE COPRI BATTERIA GOMMA - NERO BATTERY COVER TENSIONER RUBBER - BLACK COS.PEL. ref. SIMILAR ref. 1003.46805 2141714</p>
	<p>MOLLA A GAS Lunghezza [mm] 486 Corsa [mm] 200 Forza scarto [N] 250 GAS SPRING Lenght [mm] 486 Stroke [mm] 200 Waste force [N] 250 COS.PEL. ref. SIMILAR ref. 2403.44100 1306492</p>

	<p>MOLLA A GAS Lunghezza [mm] 195,5 Corsa [mm] 60 Forza scarto [N] 100 GAS SPRING Lenght [mm] 195,5 Stroke [mm] 60 Waste force [N] 100</p> <p>COS.PEL. ref. SIMILAR ref. 2403.44101 1374642</p>
	<p>MOLLA A GAS Lunghezza [mm] 585 Corsa [mm] 250 Forza scarto [N] 400 GAS SPRING Lenght [mm] 585 Stroke [mm] 250 Waste force [N] 400</p> <p>COS.PEL. ref. SIMILAR ref. 2403.45100 1435542</p>
	<p>MOLLA A GAS Lunghezza [mm] 685 Corsa [mm] 295 Forza scarto [N] 400 GAS SPRING Lenght [mm] 685 Stroke [mm] 295 Waste force [N] 400</p> <p>COS.PEL. ref. SIMILAR ref. 2403.45101 2031872</p>
	<p>DEFLETTORI LATERALI CON CLIPS SIDEWINDOW DEFLECTORS WITH CLIPS</p> <p>COS.PEL. ref. SIMILAR ref. 3003.00000 -</p>
	<p>KIT PER CONNESSIONI ELETTRICHE Connettore AMP 1,5 singolo KIT FOR ELECTRICAL JOINTS Connector AMP 1,5 simple</p> <p>COS.PEL. ref. SIMILAR ref. 003120 -</p>
	<p>KIT PER CONNESSIONI ELETTRICHE Connettore SUPERSEAL 2 vie femmina KIT FOR ELECTRICAL JOINTS Connector SUPERSEAL ways female</p> <p>COS.PEL. ref. SIMILAR ref. 003123 -</p> <p>Connettore per la serie 1500.xxxxx</p>
<p>AD ESAURIMENTO SCORTE UNTIL SELLS-OUT</p> 	<p>FANALE POSTERIORE LED REAR-LIGHT LED</p> <p>COS.PEL. ref. SIMILAR ref. 005727 -</p> <p>Con luce targa / With plate light</p> <p>TRASPARENTE / LENS 011114 -</p> <p>SX LH DX-SX RH-LH</p>
<p>AD ESAURIMENTO SCORTE UNTIL SELLS-OUT</p> 	<p>FANALE POSTERIORE LED REAR-LIGHT LED</p> <p>COS.PEL. ref. SIMILAR ref. 005732 -</p> <p>005731 - Relativo connettore 003120</p> <p>011115 - Con luce targa / With plate light - Relativo connettore 003120</p> <p>DX RH SX LH DX-SX RH-LH</p>

CR - R

<p>AD ESAURIMENTO SCORTE UNITS SHAL-OUT</p>  <p>cm 15,3</p>	<p>FANALE POSTERIORE LED REAR-LIGHT LED</p> <p>COS.PEL. ref. SIMILAR ref. 005734 - 005733 - Relativo connettore 003120 Con luce targa / With plate light</p> <p>TRASPARENTE / LENS 011115 -</p> <p>DX RH SX LH DX-SX RH-LH</p>
 <p>cm 15,2</p>	<p>FANALE POSTERIORE LED REAR-LIGHT LED</p> <p>COS.PEL. ref. SIMILAR ref. 005932 -</p> <p>005931 - Con luce targa / With plate light</p> <p>TRASPARENTE / LENS 011112 -</p> <p>DX RH SX LH DX-SX RH-LH</p>
 <p>cm 15,3</p>	<p>FANALE POSTERIORE 7 FUNZIONI - SENZA PIN CENTRALE REAR-LIGHT 7 FUNCTIONS - W/O CENTRAL PIN</p> <p>COS.PEL. ref. SIMILAR ref. 009480 1498103</p> <p>009490 1498102 Con luce targa / With plate light</p> <p>TRASPARENTE / LENS 011211 1380819</p> <p>DX RH SX LH DX-SX RH-LH</p>
 <p>15,2 cm</p>	<p>FANALE POSTERIORE LED - 24V - CONNETTORE POSTERIORE AMP 1.5 REAR-LIGHT LED - 24V - REAR CONNECTOR AMP 1.5</p> <p>COS.PEL. ref. SIMILAR ref. 1500.00000 - 1500.00001 - Relativo connettore multipolare 003120 Relativo connettore multipolare 003120</p> <p>TRASPARENTE / LENS</p> <p>DX RH SX LH</p>
 <p>cm 15,1</p>	<p>FANALE POSTERIORE LED - 24V - CONNETTORE POSTERIORE AMP 1.5 REAR-LIGHT LED - 24V - REAR CONNECTOR AMP 1.5</p> <p>COS.PEL. ref. SIMILAR ref. 1503.45000 - 1503.45001 - Relativo connettore 003120 Relativo connettore 003120</p> <p>TRASPARENTE / LENS 1503.45100 - 1503.45101 -</p> <p>DX RH SX LH DX RH SX LH</p>
 <p>cm 15,1</p>	<p>FANALE POSTERIORE LED - 24V - CONNETTORE LATERALE AMP 1.5 REAR-LIGHT LED - 24V - LATERAL CONNECTOR AMP 1.5</p> <p>COS.PEL. ref. SIMILAR ref. 1503.45002 - 1503.45003 - Relativo connettore 003120 Relativo connettore 003120</p> <p>TRASPARENTE / LENS 1503.45100 - 1503.45101 -</p> <p>DX RH SX LH DX RH SX LH</p>
 <p>cm 15,1</p>	<p>FANALE POSTERIORE LED - 24V - CONNETTORE LATERALE AMP 1.5 REAR-LIGHT LED - 24V - LATERAL CONNECTOR AMP 1.5</p> <p>COS.PEL. ref. SIMILAR ref. 1503.45005 - Con luce targa / With plate light - Relativo connettore 003120</p> <p>TRASPARENTE / LENS 1503.45101 -</p> <p>SX LH SX LH</p>
 <p>cm 15,2</p>	<p>FANALE POSTERIORE CONNETTORE LATERALE AMP 1.5 REAR-LIGHT LATERAL CONNECTOR AMP 1.5</p> <p>COS.PEL. ref. SIMILAR ref. 1503.45006 1756751 / 2021575 / 2129987 (ex 005722) - Relativo connettore 003120 1503.45007 1756754 / 2021579 / 2129985 Con luce targa / With plate light (ex 005721) - Connettore 003120</p> <p>TRASPARENTE / LENS 1503.45102 1784670 / 2129991 ex 011212/009212 1503.45103 1784669 / 2129992 ex 011213/009213</p> <p>DX RH SX LH DX RH SX LH</p>

 <p style="text-align: center;">cm 15,2</p>	<p>FANALE POSTERIORE REAR-LIGHT</p> <p>COS.PEL. ref. 1503.45008 SIMILAR ref. 1791369 / 2021576 / 2129988 DX RH Con cicalino / With buzzer (ex 005724) - Connettore 003120 1503.45009 2021578 / 2129986 SX LH Senza luce targa / W-O Plate light - Connettore 003120</p> <p>TRASPARENTE / LENS</p> <p>1503.45102 1784670 / 2129991 ex 011212/009212 DX RH 1503.45103 1784669 / 2129992 ex 011213/009213 SX LH</p> <p>CONNETTORE LATERALE AMP 1.5 LATERAL CONNECTOR AMP 1.5</p>
 <p style="text-align: center;">cm 15,2</p>	<p>FANALE POSTERIORE REAR-LIGHT</p> <p>COS.PEL. ref. 1503.45010 SIMILAR ref. 1792374 DX RH 1503.45011 1792375 SX LH Con luce targa / With plate light</p> <p>TRASPARENTE / LENS</p> <p>011211 1380819 DX-SX RH-LH</p> <p>7 FUNZIONI - CON PIN CENTRALE 7 FUNCTIONS - WITH CENTRAL PIN</p>



	<p>TELAIO GRIGLIA FRONTAL SUPPORT</p> <p>COS.PEL. ref. SIMILAR ref. 103.46145 1859174 / 1917216</p>
	<p>GRIGLIA SUPERIORE METALLO UPPER GRILLE STEEL</p> <p>COS.PEL. ref. SIMILAR ref. 103.46146 1872158</p>
	<p>GRIGLIA SUPERIORE METALLO UPPER GRILLE STEEL</p> <p>COS.PEL. ref. SIMILAR ref. 103.46149 1870592</p>
	<p>GRIGLIA CENTRALE METALLO CENTRAL GRILLE STEEL</p> <p>COS.PEL. ref. SIMILAR ref. 103.46150 1870593</p>
	<p>GRIGLIA INFERIORE METALLO INNER GRILLE STEEL</p> <p>COS.PEL. ref. SIMILAR ref. 103.46151 1870594</p>

	<p>GRIGLIA SUPERIORE variante V8 METALLO - NERO MESH UPPER FOR UPPER GRILLE STEEL - BLACK</p> <p>COS.PEL. ref. SIMILAR ref. 103.47100 1930792</p> <p>FORI / HOLES d.8 mm</p>
	<p>GRIGLIA CENTRALE variante V8 METALLO - NERO MESH MIDDLE FOR UPPER GRILLE STEEL - BLACK</p> <p>COS.PEL. ref. SIMILAR ref. 103.47101 1930793</p> <p>FORI / HOLES d.8 mm</p>
	<p>GRIGLIA INFERIORE variante V8 METALLO - NERO MESH LOWER FOR UPPER GRILLE STEEL - BLACK</p> <p>COS.PEL. ref. SIMILAR ref. 103.47102 1930794</p> <p>FORI / HOLES d.8 mm</p>
	<p>GRIGLIA PRESA ARIA SUPERIORE GRILLE</p> <p>COS.PEL. ref. SIMILAR ref. 103.46158 1870596 DX RH</p> <p>103.46159 1870595 SX LH</p>
 <p>cm 152 cm 36</p>	<p>GRIGLIA INFERIORE P.P.G.F. LOWER GRILLE P.P.G.F.</p> <p>COS.PEL. ref. SIMILAR ref. 103.46147 1885932</p>
	<p>GRIGLIA SUPERIORE CALANDRA INFERIORE GRILLE</p> <p>COS.PEL. ref. SIMILAR ref. 103.46154 1870598</p>
	<p>GRIGLIA INFERIORE CALANDRA INFERIORE GRILLE</p> <p>COS.PEL. ref. SIMILAR ref. 103.46155 1870599</p>
	<p>GRIGLIA SUPERIORE PER MASCHERINA INFERIORE METALLO - NERO UPPER GRILLE FOR LOWER MESH STEEL - BLACK</p> <p>COS.PEL. ref. SIMILAR ref. 103.47104 1930805</p> <p>FORI / HOLES d.8 mm</p>

CR - R 2010

	<p>GRIGLIA INFERIORE PER MASCHERINA INFERIORE METALLO - NERO LOWER GRILLE FOR LOWER MESH STEEL - BLACK</p> <p>COS.PEL. ref. 103.47105 SIMILAR ref. 1930806</p> <p>FORI / HOLES d.8 mm</p>
	<p>GRIGLIA CENTRALE CABINA MEDIA METALLO - PER PARAURTI ALTO CABINA CG CENTRAL GRILLE STEEL - FOR HIGH BUMPER CG CAB</p> <p>COS.PEL. ref. 103.46148 SIMILAR ref. 1872160</p>
	<p>GRIGLIA CENTRALE RADIATORE CENTRAL GRILLE</p> <p>COS.PEL. ref. 103.46152 SIMILAR ref. 1890176 / 1890787</p>
	<p>GRIGLIA CENTRALE CR CENTRAL GRILLE CR</p> <p>COS.PEL. ref. 103.46157 SIMILAR ref. 1872159</p>
	<p>GRIGLIA CENTRALE RADIATORE CENTRAL GRILLE</p> <p>COS.PEL. ref. 103.46153 SIMILAR ref. 1870597</p>
	<p>GRIGLIA CENTRALE METALLO - NERA GRILLE MESH STEEL - BLACK</p> <p>COS.PEL. ref. 103.47107 SIMILAR ref. 1930799</p>
	<p>GRIGLIA INFERIORE LOWER GRILLE</p> <p>COS.PEL. ref. 103.46160 SIMILAR ref. 1875843 / 1875858</p>
	<p>GRIGLIA SUPERIORE UPPER GRILLE</p> <p>COS.PEL. ref. 103.46156 SIMILAR ref. 1875846</p>

	<p>GRIGLIA INFERIORE LOWER GRILLE</p> <p>COS.PEL. ref. SIMILAR ref. 103.46161 1875847</p>
	<p>GRIGLIA SUPERIORE variante V8 METALLO - NERO UPPER GRILLE MESH STEEL - BLACK</p> <p>COS.PEL. ref. SIMILAR ref. 103.47108 1930811</p> <p>FORI / HOLES d.8 mm</p>
	<p>GRIGLIA INFERIORE variante V8 METALLO - NERO LOWER GRILLE MESH STEEL - BLACK</p> <p>COS.PEL. ref. SIMILAR ref. 103.47109 1930812</p> <p>FORI / HOLES d.8 mm</p>
	<p>PANNELLO SOTTOPARABREZZA WIPER PANEL</p> <p>COS.PEL. ref. SIMILAR ref. 103.46162 1451271 DX RH</p> <p>103.46163 1451270 SX LH</p>
	<p>PANNELLO SOTTOPARABREZZA CENTRALE WIPER PANEL MIDDLE</p> <p>COS.PEL. ref. SIMILAR ref. 103.46164 1866913</p>
	<p>GRIGLIA METALLO GRILLE STEEL</p> <p>COS.PEL. ref. SIMILAR ref. 103.47106 1890728</p>
	<p>GRIGLIA CENTRALE variante V8 METALLO - NERO CENTRAL GRILLE STEEL - BLACK</p> <p>COS.PEL. ref. SIMILAR ref. 103.47103 1930800</p> <p>FORI / HOLES d.8 mm</p>
	<p>PARASPRUZZI ANTISPRAY</p> <p>COS.PEL. ref. SIMILAR ref. 203.45206 1947568 DX RH</p> <p>203.45205 1947569 SX LH</p>

	<p>COPERCHIO PARAFANGO A.B.S. - GRIGIO COVER MUDGUARD A.B.S. - GREY COS.PEL. ref. SIMILAR ref. 203.46200 1540269 203.46201 1540268</p> <p>DX RH SX LH</p>
	<p>COPERCHIO PEDANA STEP PANEL COS.PEL. ref. SIMILAR ref. 203.46202 1805342 203.46203 1442655 / 1805341</p> <p>DX RH SX LH</p>
	<p>MEZZO PARAFANGO POSTERIORE SX ANTERIORE DX P.P.T. - GRIGIO REAR MUDGUARD LH FRONT RH P.P.T. - GREY COS.PEL. ref. SIMILAR ref. 203.44599 1357599</p> <p>SX LH</p>
	<p>MEZZO PARAFANGO POSTERIORE DX ANTERIORE SX P.P.T. - GRIGIO REAR MUDGUARD RH FRONT LH P.P.T. - GREY COS.PEL. ref. SIMILAR ref. 203.44600 1357600</p> <p>DX RH</p>
	<p>CALOTTA PARAF. POST. RIBASSATA CON 4 TIRANTI P.P.T. - GRIGIO REAR MUDGUARD FLAT TYPE WITH 4 MUDG. TENS. P.P.T. - GREY COS.PEL. ref. SIMILAR ref. 203.57601 1357602 / 1383858 DX-SX RH-LH (203.57602 versione senza i tiranti)</p>
	<p>CALOTTA PARAFANGO POSTERIORE RIBASSATA P.P.T. - GRIGIO REAR MUDGUARD FLAT TYPE P.P.T. - GREY COS.PEL. ref. SIMILAR ref. 203.57602 1357602 DX-SX RH-LH Relativo tirante 1003.00144 - (203.57601 versione con i tiranti)</p>
	<p>CALOTTA PARAF. POST. INTERM. CON 4 TIRANTI P.P.T. - GRIGIO REAR MUDGUARD WITH 4 MUDGUARD TENSIONERS P.P.T. - GREY COS.PEL. ref. SIMILAR ref. 203.95275 1383858 / 1395276 DX-SX RH-LH (203.95276 versione senza i tiranti)</p>
	<p>CALOTTA PARAFANGO POSTERIORE INTERMEDIO P.P.T. - GRIGIO REAR MUDGUARD STANDARD P.P.T. - GREY COS.PEL. ref. SIMILAR ref. 203.95276 1395276 DX-SX RH-LH Relativo tirante 1003.00144 - (203.95275 versione con i tiranti)</p>





	<p>CALOTTA PARAFANGO POSTERIORE ALTA P.P.T. - GRIGIO HIGH REAR MUDGUARD P.P.T. - GREY</p> <p>COS.PEL. ref. 203.95277 SIMILAR ref. 1357601 DX-SX RH-LH</p> <p>Relativo tirante 1003.00144 - (203.95278 versione con i tiranti)</p>
	<p>CALOTTA PARAFANGO POST. ALTA CON 4 TIRANTI P.P.T. - GRIGIO HIGH REAR MUDGUARD RH-LH W/TENSIONERS P.P.T. - GREY</p> <p>COS.PEL. ref. 203.95278 SIMILAR ref. 1357601 / 1383858 DX-SX RH-LH</p> <p>203.95277 : versione senza i tiranti</p>
	<p>GRIGLIA SU PARAU RTI GRILLE FOR BUMPER</p> <p>COS.PEL. ref. 403.46084 SIMILAR ref. 1865188</p> <p>Per il paraurti 403.46087</p>
	<p>GRIGLIA SU PARAU RTI GRILLE FOR BUMPER</p> <p>COS.PEL. ref. 403.46086 SIMILAR ref. 1884486 DX RH</p> <p>403.46085 1884485 SX LH</p> <p>Per il paraurti 403.46087 Per il paraurti 403.46087</p>
	<p>PARAU RTI CENTRALE (CABINA ALTA) A.B.S. CENTRAL BUMPER (HIGH CAB) A.B.S.</p> <p>COS.PEL. ref. 403.46087 SIMILAR ref. 1884483</p>
	<p>ANGOLO PARAU RTI (CABINA ALTA) A.B.S. - NERO - TAGLIO ESTERNO CORNER BUMPER (HIGH CAB) A.B.S. - BLACK</p> <p>COS.PEL. ref. 403.46088 SIMILAR ref. 1884915 DX RH</p> <p>403.46089 1884914 SX LH</p>
	<p>ANGOLO PARAU RTI (CABINA ALTA) A.B.S. - NERO - TAGLIO INTERNO CORNER BUMPER (HIGH CAB) A.B.S. - BLACK</p> <p>COS.PEL. ref. 403.46090 SIMILAR ref. 1865183 DX RH</p> <p>403.46091 1865182 SX LH</p>
	<p>ANGOLO PARAU RTI (CABINA BASSA) A.B.S. - GRIGIO - TAGLIO INTERNO CORNER BUMPER (LOW CAB) A.B.S. - GREY</p> <p>COS.PEL. ref. 403.46100 SIMILAR ref. 1923743 DX RH</p> <p>403.46101 1923742 SX LH</p>

CR - R 2010

	<p>PARAURTI CENTRALE (CABINA BASSA) A.B.S. - SENZA GRIGLIA CENTRAL BUMPER (LOW CAB) A.B.S. - WITHOUT GRILLE</p> <p>COS.PEL. ref. SIMILAR ref. 403.46102 1865178 / 2126392</p>
	<p>GRIGLIA SU PARAURTI GRILLE FOR BUMPER</p> <p>COS.PEL. ref. SIMILAR ref. 403.46103 1885996</p> <p>Per paraurti 403.46102</p>
	<p>ANGOLO PARAURTI (CABINA BASSA) A.B.S. - GRIGIO - TAGLIO ESTERNO CORNER BUMPER (LOW CAB) A.B.S. - GREY</p> <p>COS.PEL. ref. SIMILAR ref. 403.46104 1923745 DX RH</p> <p>403.46105 1923744 SX LH</p>
	<p>GRIGLIA SU PARAURTI GRILLE FOR BUMPER</p> <p>COS.PEL. ref. SIMILAR ref. 403.46106 1865186</p> <p>Per paraurti 403.46102</p>
	<p>CARENATURA SENZA STAFFE STRATIFICAZIONE MANUALE - BIANCO - PASSO 3700 FAIRING WITHOUT BRACKET G.R.P. - WHITE - WHEEL BASE 3700</p> <p>COS.PEL. ref. SIMILAR ref. 803.46802 1788757 DX RH</p> <p>803.46801 Relativo kit staffe 1003.46802 1788758 SX LH</p> <p>Relativo kit staffe 1003.46801</p>
	<p>CONVOGLIATORE ARIA INTERNO A.B.S. - GRIGIO INNER CORNER PANEL A.B.S. - GREY</p> <p>COS.PEL. ref. SIMILAR ref. 903.45228 1495957 / 1749717 / 1798864 / DX RH 1856474</p> <p>903.45229 1495956 / 1749716 / 1798863 / SX LH 1856475</p>
	<p>CONVOGLIATORE ARIA P.C.+A.B.S. - BIANCO AIR CONVEYOR P.C.+A.B.S. - WHITE</p> <p>COS.PEL. ref. SIMILAR ref. 903.45230 1538385 / 1751406 DX RH</p> <p>903.45231 1538384 / 1751405 SX LH</p>
	<p>CERNIERA GRIGLIA INFERIORE PARAURTI ALTO PROTECTOR BRACKET</p> <p>COS.PEL. ref. SIMILAR ref. 1003.46102 1889300 DX RH</p> <p>1003.46103 1889299 SX LH</p>

	<p>GRIGLIA PEDANA SUPERIORE UPPER STEP PLATE</p> <p>COS.PEL. ref. SIMILAR ref. 1003.46228 1779114 DX RH</p> <p>1003.46229 1779113 SX LH</p>
	<p>SUPPORTO PARAFANGO POSTERIORE PARTE POSTERIORE - METALLO REAR MUDGUARD BRACKET REAR PART - STEEL</p> <p>COS.PEL. ref. SIMILAR ref. 1003.46230 1942253 / 2054590 / 2476495 DX RH</p> <p>1003.46231 1942252 / 2054589 / 2476494 SX LH</p>
	<p>PANNELLO PORTA INTERNO INNER DOOR PANEL</p> <p>COS.PEL. ref. SIMILAR ref. 1403.46006 1346164 DX RH</p> <p>1403.46005 1346163 SX LH</p>
 	<p>FANALINO LATERALE 24V CORNER LAMP 24V</p> <p>COS.PEL. ref. SIMILAR ref. 1603.45535 1928063 / 2083830 DX-SX RH-LH</p>
 	<p>PROIETTORE SENZA CENTRALINA H7/H1/H21/LED - MANUALE HEADLAMP W/O CONTROL UNIT H7/H1/H21/LED - MANUAL</p> <p>COS.PEL. ref. SIMILAR ref. 1603.46500 2241827 DX RH</p> <p>1603.46501 2241826 SX LH</p>
 	<p>PROIETTORE H7/H1/H21/LED - ELETTRICO CON MOTORINO - LED HEADLAMP H7/H1/H21/LED - ELECTRIC WITH MOTOR - LED</p> <p>COS.PEL. ref. SIMILAR ref. 1603.46502 2241829 / 2416137 DX RH</p> <p>1603.46503 2241828 / 2416136 SX LH</p>
	<p>MOLLA A GAS Lunghezza [mm] 785 Corsa [mm] 345 Forza scarto [N] 250 GAS SPRING Lenght [mm] 785 Stroke [mm] 345 Waste force [N] 250</p> <p>COS.PEL. ref. SIMILAR ref. 2403.43100 1481372 / 2031866</p>
	<p>MOLLA A GAS Lunghezza [mm] 685 Corsa [mm] 295 Forza scarto [N] 250 GAS SPRING Lenght [mm] 685 Stroke [mm] 295 Waste force [N] 250</p> <p>COS.PEL. ref. SIMILAR ref. 2403.43101 1481373 / 2031868</p>

	<p>MOLLA A GAS Lunghezza [mm] 585 Corsa [mm] 250 Forza scarto [N] 400 GAS SPRING Lenght [mm] 585 Stroke [mm] 250 Waste force [N] 400</p> <p>COS.PEL. ref. SIMILAR ref. 2403.45100 1435542</p>
	<p>MOLLA A GAS Lunghezza [mm] 685 Corsa [mm] 295 Forza scarto [N] 400 GAS SPRING Lenght [mm] 685 Stroke [mm] 295 Waste force [N] 400</p> <p>COS.PEL. ref. SIMILAR ref. 2403.45101 2031872</p>
	<p>KIT PER CONNESSIONI ELETTRICHE Connettore AMP 1,5 singolo KIT FOR ELECTRICAL JOINTS Connector AMP 1,5 simple</p> <p>COS.PEL. ref. SIMILAR ref. 003120 -</p>
	<p>KIT PER CONNESSIONI ELETTRICHE Connettore SUPERSEAL 2 vie femmina KIT FOR ELECTRICAL JOINTS Connector SUPERSEAL ways female</p> <p>COS.PEL. ref. SIMILAR ref. 003123 -</p> <p>Connettore per la serie 1500.xxxxx</p>
 <p>15,2 cm</p>	<p>FANALE POSTERIORE REAR-LIGHT LED - 24V - CONNETTORE POSTERIORE AMP 1.5 LED - 24V - REAR CONNECTOR AMP 1.5</p> <p>COS.PEL. ref. SIMILAR ref. 1500.00000 - - 1500.00001 - Relativo connettore multipolare 003120 - TRASPARENTE / LENS - Relativo connettore multipolare 003120</p> <p>DX RH SX LH</p>
 <p>cm 15,1</p>	<p>FANALE POSTERIORE REAR-LIGHT LED - 24V - CONNETTORE POSTERIORE AMP 1.5 LED - 24V - REAR CONNECTOR AMP 1.5</p> <p>COS.PEL. ref. SIMILAR ref. 1503.45000 - - 1503.45001 - Relativo connettore 003120 - TRASPARENTE / LENS - Relativo connettore 003120</p> <p>DX RH SX LH</p> <p>1503.45100 - 1503.45101 -</p> <p>DX RH SX LH</p>
 <p>cm 15,1</p>	<p>FANALE POSTERIORE REAR-LIGHT LED - 24V - CONNETTORE LATERALE AMP 1.5 LED - 24V - LATERAL CONNECTOR AMP 1.5</p> <p>COS.PEL. ref. SIMILAR ref. 1503.45002 - - 1503.45003 - Relativo connettore 003120 - TRASPARENTE / LENS - Relativo connettore 003120</p> <p>DX RH SX LH</p> <p>1503.45100 - 1503.45101 -</p> <p>DX RH SX LH</p>
 <p>cm 15,1</p>	<p>FANALE POSTERIORE REAR-LIGHT LED - 24V - CONNETTORE LATERALE AMP 1.5 LED - 24V - LATERAL CONNECTOR AMP 1.5</p> <p>COS.PEL. ref. SIMILAR ref. 1503.45005 - - Con luce targa / With plate light - Relativo connettore 003120</p> <p>SX LH</p> <p>TRASPARENTE / LENS 1503.45101 -</p> <p>SX LH</p>

	<p>FANALE POSTERIORE REAR-LIGHT CONNETTORE LATERALE AMP 1.5 LATERAL CONNECTOR AMP 1.5</p> <p>COS.PEL. ref. SIMILAR ref.</p> <p>1503.45006 1756751 / 2021575 / 2129987 DX RH (ex 005722) - Relativo connettore 003120</p> <p>1503.45007 1756754 / 2021579 / 2129985 SX LH Con luce targa / With plate light (ex 005721) - Connettore 003120</p> <p>TRASPARENTE / LENS</p> <p>1503.45102 1784670 / 2129991 ex 011212/009212 DX RH</p> <p>1503.45103 1784669 / 2129992 ex 011213/009213 SX LH</p>
	<p>FANALE POSTERIORE REAR-LIGHT CONNETTORE LATERALE AMP 1.5 LATERAL CONNECTOR AMP 1.5</p> <p>COS.PEL. ref. SIMILAR ref.</p> <p>1503.45008 1791369 / 2021576 / 2129988 DX RH Con cicalino / With buzzer (ex 005724) - Connettore 003120</p> <p>1503.45009 2021578 / 2129986 SX LH Senza luce targa / W-O Plate light - Connettore 003120</p> <p>TRASPARENTE / LENS</p> <p>1503.45102 1784670 / 2129991 ex 011212/009212 DX RH</p> <p>1503.45103 1784669 / 2129992 ex 011213/009213 SX LH</p>

Nuovo Streamline



	<p>PARASPRUZZI ANTISPRAY</p> <p>COS.PEL. ref. SIMILAR ref. 203.45206 1947568</p> <p>203.45205 1947569</p> <p style="text-align: right;">DX RH</p> <p style="text-align: right;">SX LH</p>
	<p>COPERCHIO PARAFANGO A.B.S. - GRIGIO COVER MUDGUARD A.B.S. - GREY</p> <p>COS.PEL. ref. SIMILAR ref. 203.46200 1540269</p> <p>203.46201 1540268</p> <p style="text-align: right;">DX RH</p> <p style="text-align: right;">SX LH</p>
	<p>MEZZO PARAFANGO POSTERIORE SX ANTERIORE DX P.P.T. - GRIGIO REAR MUDGUARD LH FRONT RH P.P.T. - GREY</p> <p>COS.PEL. ref. SIMILAR ref. 203.44599 1357599</p> <p style="text-align: right;">SX LH</p>
	<p>MEZZO PARAFANGO POSTERIORE DX ANTERIORE SX P.P.T. - GRIGIO REAR MUDGUARD RH FRONT LH P.P.T. - GREY</p> <p>COS.PEL. ref. SIMILAR ref. 203.44600 1357600</p> <p style="text-align: right;">DX RH</p>
	<p>CALOTTA PARAF. POST. RIBASSATA CON 4 TIRANTI P.P.T. - GRIGIO REAR MUDGUARD FLAT TYPE WITH 4 MUDG. TENS. P.P.T. - GREY</p> <p>COS.PEL. ref. SIMILAR ref. 203.57601 1357602 / 1383858</p> <p style="text-align: right;">DX-SX RH-LH</p> <p style="text-align: center;">(203.57602 versione senza i tiranti)</p>

	<p>CALOTTA PARAFANGO POSTERIORE RIBASSATA P.P.T. - GRIGIO REAR MUDGUARD FLAT TYPE P.P.T. - GREY</p> <p>COS.PEL. ref. 203.57602 SIMILAR ref. 1357602 DX-SX RH-LH</p> <p>Relativo tirante 1003.00144 - (203.57601 versione con i tiranti)</p>
	<p>CALOTTA PARAF. POST. INTERM. CON 4 TIRANTI P.P.T. - GRIGIO REAR MUDGUARD WITH 4 MUDGUARD TENSIONERS P.P.T. - GREY</p> <p>COS.PEL. ref. 203.95275 SIMILAR ref. 1383858 / 1395276 DX-SX RH-LH</p> <p>(203.95276 versione senza i tiranti)</p>
	<p>CALOTTA PARAFANGO POSTERIORE INTERMEDIO P.P.T. - GRIGIO REAR MUDGUARD STANDARD P.P.T. - GREY</p> <p>COS.PEL. ref. 203.95276 SIMILAR ref. 1395276 DX-SX RH-LH</p> <p>Relativo tirante 1003.00144 - (203.95275 versione con i tiranti)</p>
	<p>CALOTTA PARAFANGO POSTERIORE ALTA P.P.T. - GRIGIO HIGH REAR MUDGUARD P.P.T. - GREY</p> <p>COS.PEL. ref. 203.95277 SIMILAR ref. 1357601 DX-SX RH-LH</p> <p>Relativo tirante 1003.00144 - (203.95278 versione con i tiranti)</p>
	<p>CALOTTA PARAFANGO POST. ALTA CON 4 TIRANTI P.P.T. - GRIGIO HIGH REAR MUDGUARD RH-LH W/TENSIONERS P.P.T. - GREY</p> <p>COS.PEL. ref. 203.95278 SIMILAR ref. 1357601 / 1383858 DX-SX RH-LH</p> <p>203.95277 : versione senza i tiranti</p>
	<p>COPERCHIO PEDANA STEP PANEL</p> <p>COS.PEL. ref. 303.47240 SIMILAR ref. 1946924 DX RH</p> <p>303.47241 1946923 SX LH</p>
	<p>PARAURTI CENTRALE (CABINA ALTA) A.B.S. CENTRAL BUMPER (HIGH CAB) A.B.S.</p> <p>COS.PEL. ref. 403.46087 SIMILAR ref. 1884483</p>
	<p>ANGOLO PARAURTI (CABINA ALTA) A.B.S. - NERO - TAGLIO ESTERNO CORNER BUMPER (HIGH CAB) A.B.S. - BLACK</p> <p>COS.PEL. ref. 403.46088 SIMILAR ref. 1884915 DX RH</p> <p>403.46089 1884914 SX LH</p>

Nuovo Streamline



	<p>ANGOLO PARAU RTI (CABINA ALTA) A.B.S. - NERO - TAGLIO INTERNO CORNER BUMPER (HIGH CAB) A.B.S. - BLACK COS.PEL. ref. SIMILAR ref. 403.46090 1865183 DX RH</p> <p>403.46091 1865182 SX LH</p>
	<p>ANGOLO PARAU RTI (CABINA BASSA) A.B.S. - GRIGIO - TAGLIO INTERNO CORNER BUMPER (LOW CAB) A.B.S. - GREY COS.PEL. ref. SIMILAR ref. 403.46100 1923743 DX RH</p> <p>403.46101 1923742 SX LH</p>
	<p>PARAU RTI CENTRALE (CABINA BASSA) A.B.S. - SENZA GRIGLIA CENTRAL BUMPER (LOW CAB) A.B.S. - WITHOUT GRILLE COS.PEL. ref. SIMILAR ref. 403.46102 1865178 / 2126392</p>
	<p>ANGOLO PARAU RTI (CABINA BASSA) A.B.S. - GRIGIO - TAGLIO ESTERNO CORNER BUMPER (LOW CAB) A.B.S. - GREY COS.PEL. ref. SIMILAR ref. 403.46104 1923745 DX RH</p> <p>403.46105 1923744 SX LH</p>
	<p>VISIERA PARASOLE INFERIORE LOWER SUN VISOR COS.PEL. ref. SIMILAR ref. 703.47700 2058757</p>
	<p>VISIERA PARASOLE SUPERIORE UPPER SUN VISOR COS.PEL. ref. SIMILAR ref. 703.47701 2117867 / 2117871</p>
	<p>VISIERA PARASOLE SUPERIORE 2 fori UPPER SUN VISOR 2 holes COS.PEL. ref. SIMILAR ref. 703.47702 2117868</p>
	<p>VISIERA PARASOLE SUPERIORE 2+3 fori UPPER SUN VISOR 2+3 holes COS.PEL. ref. SIMILAR ref. 703.47703 2117870</p>

	<p>CONVOGLIATORE ARIA S.M.C. - BIANCO AIR CONVEYOR S.M.C. - WHITE COS.PEL. ref. SIMILAR ref. 903.47600 2055972</p> <p style="text-align: right;">DX RH</p> <p>903.47601 2055973</p> <p style="text-align: right;">SX LH</p>
	<p>SOTTOCONVOGLIATORE P.P. - Nero PANEL CORNER COVER P.P. - Black COS.PEL. ref. SIMILAR ref. 903.47602 2162653</p> <p style="text-align: right;">DX RH</p> <p>903.47603 2162652</p> <p style="text-align: right;">SX LH</p>
	<p>SOTTOCONVOGLIATORE P.P. - Nero PANEL CORNER COVER P.P. - Black COS.PEL. ref. SIMILAR ref. 903.47604 2126956</p> <p style="text-align: right;">DX RH</p> <p>903.47605 2126955</p> <p style="text-align: right;">SX LH</p>
	<p>FANALINO LATERALE 24V CORNER LAMP 24V</p> <p>COS.PEL. ref. SIMILAR ref. 1603.45535 1928063 / 2083830</p> <p style="text-align: right;">DX-SX RH-LH</p>
	<p>KIT PER CONNESSIONI ELETTRICHE Connettore AMP 1,5 singolo KIT FOR ELECTRICAL JOINTS Connector AMP 1,5 simple</p> <p>COS.PEL. ref. SIMILAR ref. 003120 -</p>
	<p>KIT PER CONNESSIONI ELETTRICHE Connettore SUPERSEAL 2 vie femmina KIT FOR ELECTRICAL JOINTS Connector SUPERSEAL ways female</p> <p>COS.PEL. ref. SIMILAR ref. 003123 -</p> <p style="text-align: right;">Connettore per la serie 1500.xxxxx</p>
 <p style="text-align: center;">15,2 cm</p>	<p>FANALE POSTERIORE LED - 24V - CONNETTORE POSTERIORE AMP 1.5 REAR-LIGHT LED - 24V - REAR CONNECTOR AMP 1.5</p> <p>COS.PEL. ref. SIMILAR ref. 1500.00000 -</p> <p>1500.00001 - Relativo connettore multipolare 003120</p> <p>1500.00002 - Relativo connettore multipolare 003120</p> <p>TRASPARENTE / LENS</p> <p style="text-align: right;">DX RH</p> <p style="text-align: right;">SX LH</p>
 <p style="text-align: center;">15,2 cm</p>	<p>FANALE POSTERIORE LED - 24V - CONNETTORE POSTERIORE AMP 1.5 REAR-LIGHT LED - 24V - REAR CONNECTOR AMP 1.5</p> <p>COS.PEL. ref. SIMILAR ref. 1503.45000 -</p> <p>1503.45001 - Relativo connettore 003120</p> <p>1503.45002 - Relativo connettore 003120</p> <p>TRASPARENTE / LENS</p> <p>1503.45100 -</p> <p>1503.45101 -</p> <p style="text-align: right;">DX RH</p> <p style="text-align: right;">SX LH</p> <p style="text-align: right;">DX RH</p> <p style="text-align: right;">SX LH</p>

Nuovo Streamline

	<p>FANALE POSTERIORE REAR-LIGHT LED - 24V - CONNETTORE LATERALE AMP 1.5 LED - 24V - LATERAL CONNECTOR AMP 1.5</p> <p>COS.PEL. ref. SIMILAR ref.</p> <p>1503.45002 -</p> <p>1503.45003 -</p> <p>TRASPARENTE / LENS</p> <p>1503.45100 -</p> <p>1503.45101 -</p> <p>Relativo connettore 003120</p> <p>Relativo connettore 003120</p> <p>DX RH</p> <p>SX LH</p> <p>DX RH</p> <p>SX LH</p>
	<p>FANALE POSTERIORE REAR-LIGHT LED - 24V - CONNETTORE LATERALE AMP 1.5 LED - 24V - LATERAL CONNECTOR AMP 1.5</p> <p>COS.PEL. ref. SIMILAR ref.</p> <p>1503.45005 -</p> <p>TRASPARENTE / LENS</p> <p>1503.45101 -</p> <p>Con luce targa / With plate light - Relativo connettore 003120</p> <p>SX LH</p> <p>SX LH</p>



	<p>GRIGLIA GRILLE</p> <p>COS.PEL. ref. SIMILAR ref. 103.48100 2307679</p>
	<p>MOSTRINA SUPERIORE UPPER PANEL</p> <p>COS.PEL. ref. SIMILAR ref. 103.48102 2297703 DX RH</p> <p>103.48101 2297701 SX LH</p>
	<p>MOSTRINA SUPERIORE UPPER PANEL</p> <p>COS.PEL. ref. SIMILAR ref. 103.48104 2443020 DX RH</p> <p>103.48103 2443019 SX LH</p>
	<p>GRIGLIA GRILLE</p> <p>COS.PEL. ref. SIMILAR ref. 103.48105 2307678</p>
	<p>MOSTRINA CENTRALE CENTRAL PANEL</p> <p>COS.PEL. ref. SIMILAR ref. 103.48106 2324353 DX RH</p> <p>103.48107 2324352 SX LH</p>

Sca 2017

COS.SCA

	<p>GRIGLIA INFERIORE LOWER GRILLE</p> <p>COS.PEL. ref. 103.48108 SIMILAR ref. 2329070</p>
	<p>LISTELLO PANEL</p> <p>COS.PEL. ref. 103.48109 SIMILAR ref. 2324355</p>
	<p>MOSTRINA PANEL</p> <p>COS.PEL. ref. 103.48110 SIMILAR ref. 2324367 DX RH</p> <p>103.48111 2324356 SX LH</p>
	<p>GRIGLIA GRILLE</p> <p>COS.PEL. ref. 103.48112 SIMILAR ref. 2305632</p>
	<p>MOSTRINA CENTRALE CENTRAL PANEL</p> <p>COS.PEL. ref. 103.48114 SIMILAR ref. 2324369 / 2584637 DX RH</p> <p>103.48113 2324368 / 2584635 SX LH</p>
	<p>TAPPO RADAR RADAR COVER</p> <p>COS.PEL. ref. 103.48115 SIMILAR ref. 2310450</p>
	<p>SUPPORTO GRIGLIA SUPERIORE/CENTRALE FINE UPPER/CENTRAL GRILLE BRACKET FINE</p> <p>COS.PEL. ref. 103.48116 SIMILAR ref. 2329044</p>
	<p>SUPPORTO GRIGLIA INFERIORE SPESSA LOWER GRILLE BRACKET THICK</p> <p>COS.PEL. ref. 103.48117 SIMILAR ref. 2329046</p>

	<p>SUPPORTO GRIGLIA GRILLE BRACKET</p> <p>COS.PEL. ref. SIMILAR ref. 103.48118 2614806</p> <p>103.48119 2614805</p> <p style="text-align: right;">DX RH</p> <p style="text-align: right;">SX LH</p>
	<p>FRONTALE FRONT PANEL</p> <p>COS.PEL. ref. SIMILAR ref. 103.48120 2542870</p>
	<p>FRONTALE FRONT PANEL</p> <p>COS.PEL. ref. SIMILAR ref. 103.48121 2502345</p>
	<p>GRIGLIA FRONTALE FRONT GRILLE</p> <p>COS.PEL. ref. SIMILAR ref. 103.48122 2286062</p>
	<p>GRIGLIA FRONTALE FRONT GRILLE</p> <p>COS.PEL. ref. SIMILAR ref. 103.48123 2392771</p>
	<p>COPERTURA GRIGLIA SUPERIORE UPPER GRILLE COVER</p> <p>COS.PEL. ref. SIMILAR ref. 103.48124 2324293</p> <p>103.48125 2324292</p> <p style="text-align: right;">DX RH</p> <p style="text-align: right;">SX LH</p>
	<p>COPERTURA GRIGLIA CENTRALE MIDDLE GRILLE COVER</p> <p>COS.PEL. ref. SIMILAR ref. 103.48126 2324347</p> <p>103.48127 2324296</p> <p style="text-align: right;">DX RH</p> <p style="text-align: right;">SX LH</p>
	<p>COPERTURA GRIGLIA INFERIORE LOWER GRILLE COVER</p> <p>COS.PEL. ref. SIMILAR ref. 103.48128 2324349</p> <p>103.48129 2324348</p> <p style="text-align: right;">DX RH</p> <p style="text-align: right;">SX LH</p>

Sca 2017

	<p>COPERTURA GRIGLIA SUPERIORE UPPER GRILLE COVER</p> <p>COS.PEL. ref. SIMILAR ref. 103.48130 2507858</p> <p>103.48131 2507857</p> <p style="text-align: right;">DX RH</p> <p style="text-align: right;">SX LH</p>
	<p>STRISCIA DECORATIVA DECORATIVE STRIP</p> <p>COS.PEL. ref. SIMILAR ref. 103.48132 2183824</p> <p>103.48133 2183823</p> <p style="text-align: right;">DX RH</p> <p style="text-align: right;">SX LH</p>
	<p>SUPPORTO GRIGLIA FRONTALE (CABINA ALTA) METALLO - NERO FRONT GRILLE BRACKET (HIGH CAB)</p> <p>COS.PEL. ref. SIMILAR ref. 103.48134 2365426</p>
	<p>SUPPORTO GRIGLIA FRONTALE (CABINA MEDIA) METALLO - NERO FRONT GRILLE BRACKET (MID CAB)</p> <p>COS.PEL. ref. SIMILAR ref. 103.48135 2365443</p>
	<p>SUPPORTO GRIGLIA FRONTALE (CABINA BASSA) FRONT GRILLE BRACKET (LOW CAB)</p> <p>COS.PEL. ref. SIMILAR ref. 103.48136 2535458</p>
	<p>PARAFANGHINO LATERALE ANTERIORE A.B.S. MUDGUARD A.B.S.</p> <p>COS.PEL. ref. SIMILAR ref. 203.48200 2297984</p> <p>203.48201 2297983</p> <p style="text-align: right;">DX RH</p> <p style="text-align: right;">SX LH</p>
	<p>PARAFANGHINO LATERALE ANTERIORE CON TAGLIO A.B.S. MUDGUARD A.B.S.</p> <p>COS.PEL. ref. SIMILAR ref. 203.48202 2403512</p> <p>203.48203 2403511</p> <p style="text-align: right;">DX RH</p> <p style="text-align: right;">SX LH</p>
	<p>PARAFANGO LATERALE PARTE CENTRALE A.B.S. SIDE MUDGUARD CENTRAL PART A.B.S.</p> <p>COS.PEL. ref. SIMILAR ref. 203.48204 2297992</p> <p>203.48205 2297991</p> <p style="text-align: right;">DX RH</p> <p style="text-align: right;">SX LH</p>

 <p>cm 13 cm 78</p>	<p>PARAFANGO LATERALE PARTE POSTERIORE A.B.S. SIDE MUDGUARD REAR PART A.B.S. COS.PEL. ref. SIMILAR ref. 203.48206 2297996 DX RH</p> <p>203.48207 2297995 SX LH</p>
	<p>PARAFANGO LATERALE PARTE CENTRALE A.B.S. SIDE MUDGUARD CENTRAL PART A.B.S. COS.PEL. ref. SIMILAR ref. 203.48208 2297994 DX RH</p> <p>203.48209 2297993 SX LH</p>
	<p>COPERCHIO PARAFANGO P.P.T. - GRIGIO SCURO COVER MUDGUARD P.P.T. - DARK GRAY COS.PEL. ref. SIMILAR ref. 203.48210 2246831 DX RH</p> <p>203.48211 2246830 SX LH</p>
 <p>cm 17 cm 62,5 15°</p>	<p>PARAFANGO LATERALE PARTE ANTERIORE A.B.S. MUDGUARD A.B.S. COS.PEL. ref. SIMILAR ref. 203.48212 2304676 DX RH</p> <p>203.48213 2304675 SX LH</p>
 <p>cm 17 cm 72,5 15°</p>	<p>PARAFANGO LATERALE PARTE ANTERIORE A.B.S. MUDGUARD A.B.S. COS.PEL. ref. SIMILAR ref. 203.48214 2304658 DX RH</p> <p>203.48215 2304657 SX LH</p>
 <p>cm 17 cm 72,5 15°</p>	<p>PARAFANGO LATERALE PARTE ANTERIORE TAGLIATO A.B.S. MUDGUARD A.B.S. COS.PEL. ref. SIMILAR ref. 203.48216 2403516 DX RH</p> <p>203.48217 2403515 SX LH</p>
 <p>cm 13 cm 62,5 15°</p>	<p>PARAFANGO LATERALE PARTE ANTERIORE A.B.S. MUDGUARD A.B.S. COS.PEL. ref. SIMILAR ref. 203.48218 2297990 DX RH</p> <p>203.48219 2297989 SX LH</p>
 <p>cm 13 cm 72,5 15°</p>	<p>PARAFANGO LATERALE PARTE ANTERIORE A.B.S. MUDGUARD A.B.S. COS.PEL. ref. SIMILAR ref. 203.48220 2297988 DX RH</p> <p>203.48221 2297987 SX LH</p>

Sca 2017

	<p>PARAFANGO LATERALE PARTE ANTERIORE TAGLIATO A.B.S. MUDGUARD A.B.S. COS.PEL. ref. SIMILAR ref. 203.48222 2403514 DX RH</p> <p>203.48223 2403513 SX LH</p>
	<p>PARAFANGO LATERALE PARTE ANTERIORE A.B.S. MUDGUARD A.B.S. COS.PEL. ref. SIMILAR ref. 203.48224 2297986 DX RH</p> <p>203.48225 2297985 SX LH</p>
	<p>PARAFANGO LATERALE PARTE POSTERIORE A.B.S. SIDE MUDGUARD REAR PART A.B.S. COS.PEL. ref. SIMILAR ref. 203.48226 2304678 DX RH</p> <p>203.48227 2304677 SX LH</p>
	<p>PARAFANGO LATERALE PARTE POSTERIORE A.B.S. SIDE MUDGUARD REAR PART A.B.S. COS.PEL. ref. SIMILAR ref. 203.48228 2304662 DX RH</p> <p>203.48229 2304661 SX LH</p>
	<p>PARAFANGO LATERALE PARTE POSTERIORE A.B.S. SIDE MUDGUARD REAR PART A.B.S. COS.PEL. ref. SIMILAR ref. 203.48230 2297998 DX RH</p> <p>203.48231 2297997 SX LH</p>
	<p>PARAFANGO LATERALE PARTE CENTRALE A.B.S. SIDE MUDGUARD CENTRAL PART A.B.S. COS.PEL. ref. SIMILAR ref. 203.48232 2304660 DX RH</p> <p>203.48233 2304659 SX LH</p>
	<p>TAPPO COPERCHIO PARAFANGO P.P.T. - GRIGIO SCURO COVER MUDGUARD P.P.T. - DARK GRAY COS.PEL. ref. SIMILAR ref. 203.48234 2246834 DX-SX RH-LH</p>
	<p>ATTACCO PARAFANGO CENTRALE COVER MUDGUARD COS.PEL. ref. SIMILAR ref. 203.48236 2298022 DX RH</p> <p>203.48235 2443021 SX LH</p>

	<p>PARAFANGO ANTERIORE FRONT MUDGUARD</p> <p>COS.PEL. ref. SIMILAR ref. 203.48238 2298046 / 2599550 DX RH</p> <p>203.48237 2298045 / 2599549 SX LH</p>
	<p>MEZZO PARAFANGO POSTERIORE SX ANTERIORE DX P.P.T. - GRIGIO SCURO REAR MUDGUARD LH FRONT RH P.P.T. - DARK GREY</p> <p>COS.PEL. ref. SIMILAR ref. 203.48239 2302630 SX LH</p>
	<p>MEZZO PARAFANGO POSTERIORE DX ANTERIORE LX P.P.T. - GRIGIO SCURO REAR MUDGUARD RH FRONT LH P.P.T. - DARK GREY</p> <p>COS.PEL. ref. SIMILAR ref. 203.48240 2302631 DX RH</p>
	<p>CALOTTA PARAF. POST. RIBASSATA CON 4 TIRANTI P.P.T. - GRIGIO SCURO REAR MUDGUARD FLAT TYPE WITH 4 MUDG. TENS. P.P.T. - DARK GREY</p> <p>COS.PEL. ref. SIMILAR ref. 203.48241 1383858 / 2246819 DX-SX RH-LH</p> <p>(203.48242 versione senza i tiranti)</p>
	<p>CALOTTA PARAFANGO POSTERIORE RIBASSATA P.P.T. - GRIGIO SCURO REAR MUDGUARD FLAT TYPE P.P.T. - DARK GREY</p> <p>COS.PEL. ref. SIMILAR ref. 203.48242 2246819 DX-SX RH-LH</p> <p>Relativo tirante 1003.00144 - (203.48241 versione con i tiranti)</p>
	<p>CALOTTA PARAF. POST. INTERM. CON 4 TIRANTI P.P.T. - GRIGIO SCURO REAR MUDGUARD WITH 4 MUDGUARD TENSIONERS P.P.T. - DARK GREY</p> <p>COS.PEL. ref. SIMILAR ref. 203.48243 1383858 / 2246818 DX-SX RH-LH</p> <p>(203.48244 versione senza i tiranti)</p>
	<p>CALOTTA PARAFANGO POSTERIORE INTERMEDIO P.P.T. - GRIGIO SCURO REAR MUDGUARD STANDARD P.P.T. - DARK GREY</p> <p>COS.PEL. ref. SIMILAR ref. 203.48244 2246818 DX-SX RH-LH</p> <p>Relativo tirante 1003.00144 - (203.48243 versione con i tiranti)</p>
	<p>PEDANA BASSA A.B.S. FOOTSTEP LOW A.B.S.</p> <p>COS.PEL. ref. SIMILAR ref. 303.48100 2559304 / 2559310 DX RH</p> <p>303.48101 2559303 / 2559309 SX LH</p>

Sca 2017





	<p>PEDANA MEDIA A.B.S. FOOTSTEP MIDDLE A.B.S.</p> <p>COS.PEL. ref. SIMILAR ref. 303.48102 2349684 / 2349686</p> <p>303.48103 2349683 / 2349685</p> <p style="text-align: right;">DX RH</p> <p style="text-align: right;">SX LH</p>
	<p>PEDANA ALTA A.B.S. FOOTSTEP HIGHT A.B.S.</p> <p>COS.PEL. ref. SIMILAR ref. 303.48104 2559298 / 2559302</p> <p>303.48105 2559297 / 2559301</p> <p style="text-align: right;">DX RH</p> <p style="text-align: right;">SX LH</p>
	<p>SPORTELLLO PEDANA ALTA A.B.S. COVER HIGHT FOOTSTEP A.B.S.</p> <p>COS.PEL. ref. SIMILAR ref. 303.48106 2229102 / 2559305</p> <p style="text-align: right;">SX LH</p>
	<p>SPORTELLLO PEDANA BASSA A.B.S. COVER LOW FOOTSTEP A.B.S.</p> <p>COS.PEL. ref. SIMILAR ref. 303.48107 2559306</p> <p style="text-align: right;">SX LH</p>
	<p>SPORTELLLO PEDANA MEDIA A.B.S. COVER MIDDLE FOOTSTEP A.B.S.</p> <p>COS.PEL. ref. SIMILAR ref. 303.48108 2349687</p> <p style="text-align: right;">SX LH</p>
	<p>PARAURTI CENTRALE CENTRAL BUMPER</p> <p>COS.PEL. ref. SIMILAR ref. 403.48090 2311419</p>
	<p>ANGOLO PARAURTI CORNER BUMPER</p> <p>COS.PEL. ref. SIMILAR ref. 403.48092 2295950</p> <p>403.48091 2295948</p> <p style="text-align: right;">DX RH</p> <p style="text-align: right;">SX LH</p>
	<p>PARAURTI CENTRALE CENTER BUMPER</p> <p>COS.PEL. ref. SIMILAR ref. 403.48093 2077928</p>

	<p>ANGOLO PARAURTI CORNER BUMPER</p> <p>COS.PEL. ref. SIMILAR ref. 403.48094 2077927</p> <p>403.48095 2077926</p> <p style="text-align: right;">DX RH</p> <p style="text-align: right;">SX LH</p>
	<p>PARAURTI CENTRALE ALTO CENTRAL BUMPER</p> <p>COS.PEL. ref. SIMILAR ref. 403.48096 2311420</p>
	<p>ANGOLO PARAURTI ALTO CORNER BUMPER</p> <p>COS.PEL. ref. SIMILAR ref. 403.48098 2295955</p> <p>403.48097 2295953</p> <p style="text-align: right;">DX RH</p> <p style="text-align: right;">SX LH</p>
	<p>TAPPO PARAURTI BASSO LOW COVER BUMPER</p> <p>COS.PEL. ref. SIMILAR ref. 403.48100 2311427</p> <p>403.48099 2311423</p> <p style="text-align: right;">DX RH</p> <p style="text-align: right;">SX LH</p>
	<p>TAPPO PARAURTI MEDIO MIDDLE COVER BUMPER</p> <p>COS.PEL. ref. SIMILAR ref. 403.48102 2128512</p> <p>403.48101 2128511</p> <p style="text-align: right;">DX RH</p> <p style="text-align: right;">SX LH</p>
	<p>TAPPO PARAURTI ALTO UPPER COVER BUMPER</p> <p>COS.PEL. ref. SIMILAR ref. 403.48104 2311428</p> <p>403.48103 2311424</p> <p style="text-align: right;">DX RH</p> <p style="text-align: right;">SX LH</p>
	<p>CONVOGLIATORE ARIA - CABINA CS AIR CONVEYOR</p> <p>COS.PEL. ref. SIMILAR ref. 903.48600 2230751</p> <p>903.48601 2230750</p> <p style="text-align: right;">DX RH</p> <p style="text-align: right;">SX LH</p>
	<p>CONVOGLIATORE ARIA - CABINA CR AIR CONVEYOR</p> <p>COS.PEL. ref. SIMILAR ref. 903.48602 2230757</p> <p>903.48603 2230756</p> <p style="text-align: right;">DX RH</p> <p style="text-align: right;">SX LH</p>

	<p>CONVOGLIATORE ARIA - CABINA CP/CL AIR CONVEYOR</p> <p>COS.PEL. ref. 903.48604 SIMILAR ref. 2402042 DX RH</p> <p>903.48605 2402039 SX LH</p>
	<p>CONVOGLIATORE ARIA - CABINA CG AIR CONVEYOR</p> <p>COS.PEL. ref. 903.48606 SIMILAR ref. 2402035 DX RH</p> <p>903.48607 2402012 SX LH</p>
	<p>GUARNIZIONE PEDANA FOOTSTEP GASKET</p> <p>COS.PEL. ref. 1003.48100 SIMILAR ref. 2341865</p> <p>Relativa pedana: 303.48102/3/4/5</p>
	<p>GUARNIZIONE PEDANA FOOTSTEP GASKET</p> <p>COS.PEL. ref. 1003.48101 SIMILAR ref. 2360072</p> <p>Relativa pedana: 303.48100/1</p>
	<p>CERNIERA HINGE</p> <p>COS.PEL. ref. 1003.48102 SIMILAR ref. 2492752 DX RH</p> <p>1003.48103 2492751 SX LH</p>
	<p>GRIGLIA PEDANA INFERIORE LOWER FOOTSTEP GRILLE</p> <p>COS.PEL. ref. 1003.48108 SIMILAR ref. 2234214</p>
	<p>GRIGLIA PEDANA INFERIORE LOWER FOOTSTEP GRILLE</p> <p>COS.PEL. ref. 1003.48109 SIMILAR ref. 2226746</p>
	<p>GRIGLIA PEDANA SUPERIORE UPPER FOOTSTEP GRILLE</p> <p>COS.PEL. ref. 1003.48110 SIMILAR ref. 2226744</p>

	<p>CORNICE FARO A.B.S. - GRIGIO HEADLAMP FRAME A.B.S. - GREY COS.PEL. ref. SIMILAR ref. 1103.48900 2592645 DX RH</p> <p>1103.48901 2592644 SX LH</p>
	<p>TAPPO CORNICE FARO A.B.S. - GRIGIO HEADLAMP FRAME COVER A.B.S. - GREY COS.PEL. ref. SIMILAR ref. 1103.48902 2394401 / 2533983 DX RH</p> <p>1103.48903 2394400 SX LH</p>
 	<p>FANALINO LED 4 LED CORNER LAMP LED 4 LED COS.PEL. ref. SIMILAR ref. 1603.48606 2334728 DX RH</p> <p>1603.48607 2334727 SX LH</p>
	<p>PROIETTORE H7*2 + H21W + LED HEADLAMP H7*2 + H21W + LED COS.PEL. ref. SIMILAR ref. 1603.48600 2379894 / 2655843 DX RH</p> <p>1603.48601 2379890 / 2655842 SX LH</p>
	<p>PROIETTORE H7*2 + H21W + LED HEADLAMP H7*2 + H21W + LED COS.PEL. ref. SIMILAR ref. 1603.48602 2379893 / 2655841 DX RH</p> <p>1603.48603 2373889 / 2655840 SX LH</p>
	<p>TIRANTE PARAFANGO GOMMA - NERO MUDGUARD TENSIONER RUBBER - BLACK COS.PEL. ref. SIMILAR ref. 1003.00144 1383858</p>
	<p>KIT PER CONNESSIONI ELETTRICHE Connettore AMP 1,5 singolo KIT FOR ELECTRICAL JOINTS Connector AMP 1,5 simple COS.PEL. ref. SIMILAR ref. 003120 -</p>
	<p>FANALE POSTERIORE LED - 24V - CONNETTORE POSTERIORE AMP 1.5 REAR-LIGHT LED - 24V - REAR CONNECTOR AMP 1.5 COS.PEL. ref. SIMILAR ref. 1503.45000 - DX RH 1503.45001 - Relativo connettore 003120 SX LH 1503.45100 - Relativo connettore 003120 DX RH 1503.45101 - SX LH</p>

Sca 2017

	<p>FANALE POSTERIORE REAR-LIGHT LED - 24V - CONNETTORE LATERALE AMP 1.5 LED - 24V - LATERAL CONNECTOR AMP 1.5</p> <p>COS.PEL. ref. SIMILAR ref. 1503.45002 - 1503.45003 - TRASPARENTE / LENS 1503.45100 - 1503.45101 -</p> <p>Relativo connettore 003120 Relativo connettore 003120</p> <p>DX RH SX LH DX RH SX LH</p>
	<p>FANALE POSTERIORE REAR-LIGHT LED - 24V - CONNETTORE LATERALE AMP 1.5 LED - 24V - LATERAL CONNECTOR AMP 1.5</p> <p>COS.PEL. ref. SIMILAR ref. 1503.45005 - Con luce targa / With plate light - Relativo connettore 003120</p> <p>TRASPARENTE / LENS 1503.45101 -</p> <p>SX LH SX LH</p>
	<p>FANALE POSTERIORE REAR-LIGHT CONNETTORE LATERALE AMP 1.5 LATERAL CONNECTOR AMP 1.5</p> <p>COS.PEL. ref. SIMILAR ref. 1503.45006 1756751 / 2021575 / 2129987 (ex 005722) - Relativo connettore 003120 1503.45007 1756754 / 2021579 / 2129985 Con luce targa / With plate light (ex 005721) - Connettore 003120</p> <p>TRASPARENTE / LENS 1503.45102 1784670 / 2129991 ex 011212/009212 1503.45103 1784669 / 2129992 ex 011213/009213</p> <p>DX RH SX LH DX RH SX LH</p>
	<p>FANALE POSTERIORE REAR-LIGHT CONNETTORE LATERALE AMP 1.5 LATERAL CONNECTOR AMP 1.5</p> <p>COS.PEL. ref. SIMILAR ref. 1503.45008 1791369 / 2021576 / 2129988 Con cicalino / With buzzer (ex 005724) - Connettore 003120 1503.45009 2021578 / 2129986 Senza luce targa / W-O Plate light - Connettore 003120</p> <p>TRASPARENTE / LENS 1503.45102 1784670 / 2129991 ex 011212/009212 1503.45103 1784669 / 2129992 ex 011213/009213</p> <p>DX RH SX LH DX RH SX LH</p>













Parti di ricambio adattabili a:
Spare parts suitable to:



	<p>GRIGLIA A.B.S. - NERO GRILLE A.B.S. - BLACK</p> <p>COS.PEL. ref. 104.55008 SIMILAR ref. 1700387 / 1700802</p>
	<p>GRIGLIA A.B.S. - NERO GRILLE A.B.S. - BLACK</p> <p>COS.PEL. ref. 104.55009 SIMILAR ref. 1400506</p>
	<p>FRONTALE S.M.C. FRONT PANEL S.M.C.</p> <p>COS.PEL. ref. 104.55010 SIMILAR ref. 1400501 / 1405008</p>
	<p>FRONTALE INFERIORE S.M.C. LOWER FRONT PANEL S.M.C.</p> <p>COS.PEL. ref. 104.55011 SIMILAR ref. 1401828 / 1405015</p>
	<p>FRONTALE S.M.C. - NERO FRONT PANEL S.M.C. - BLACK</p> <p>COS.PEL. ref. 104.55012 SIMILAR ref. 1700801 / 1701375</p>

	<p>PEDANA PARAFANGO S.M.C. - GRIGIO MUDGUARD FOOTSTEP S.M.C. - GREY COS.PEL. ref. SIMILAR ref.</p> <p>204.55020 1405250 / 1408232 DX RH</p> <p>204.55021 Griglia/Grille : 1004.55001 1405247 / 1408227 SX LH</p> <p>Griglia/Grille : 1004.55001</p>
	<p>PARAFANGO ANTERIORE FRONT WHEEL MUDGUARD</p> <p>COS.PEL. ref. SIMILAR ref.</p> <p>204.55022 1400636 / 1404997 / 1701040 DX RH</p> <p>204.55023 1400637 / 1404998 / 1701039 SX LH</p>
	<p>PEDANA S.M.C. - GRIGIO FOOTSTEP S.M.C. - GREY COS.PEL. ref. SIMILAR ref.</p> <p>304.55030 1405244 / 1405263 / 1405991 DX RH</p> <p>304.55031 Montano la griglia 1004.55000 1405243 / 1405262 / 1405990 SX LH</p> <p>Montano la griglia 1004.55000</p>
	<p>PARAURTI ANTERIORE METALLO - SENZA FORI FENDI FRONT BUMPER STEEL - W/O HOLES FOG LAMP</p> <p>COS.PEL. ref. SIMILAR ref.</p> <p>404.55089 1405032 / 1405767</p>
	<p>PARAURTI ANTERIORE METALLO - CON FORI FENDI FRONT BUMPER STEEL - WITH HOLES FOG LAMP</p> <p>COS.PEL. ref. SIMILAR ref.</p> <p>404.55090 1405027 / 1405766</p>
	<p>CANTONALE PARAURTI S.M.C. - GRIGIO CORNER BUMPER S.M.C. - GREY COS.PEL. ref. SIMILAR ref.</p> <p>404.55092 1405031 / 1405881 / 1700877 DX RH</p> <p>404.55091 1401824 / 1405030 / 1405880 SX LH</p>
	<p>TAPPO PARAURTI LATERALE FRONT BUMPER END CAP</p> <p>COS.PEL. ref. SIMILAR ref.</p> <p>404.55094 1400502 / 1405010 DX RH</p> <p>404.55093 1400503 / 1405011 SX LH</p>
	<p>SPECCHIO GUARDARUOTA ROOF MIRROR</p> <p>COS.PEL. ref. SIMILAR ref.</p> <p>501.30418 1409962 / 1526649 DX RH</p>

	<p>SPECCHIO RETROVISORE ELETTRICO - RISCALDATO - NERO - BRACCIO CORTO 100 REAR-VIEW MIRROR ELECTRIC - HEATED - BLACK - SHORT ARM 100 COS.PEL. ref. SIMILAR ref. 501.31506 1700306 / 1704604</p> <p>501.31505 1700303</p> <p style="text-align: right;">DX RH SX LH</p>
	<p>SPECCHIO RETROVISORE ELETTRICO - RISCALDATO - NERO - BRACCIO LUNGO 200 REAR-VIEW MIRROR ELECTRIC - HEATED - BLACK - LONG ARM 200 COS.PEL. ref. SIMILAR ref. 501.31508 1700269 / 1704605</p> <p>501.31507 1700265</p> <p style="text-align: right;">DX RH SX LH</p>
	<p>BRACCIO SPECCHIO LUNGO BRACCIO LUNGO 200 - FORNITO DI CAVI MIRROR BRACKET LONG LONG ARM 200 - WITH CABLES COS.PEL. ref. SIMILAR ref. 501.31510 1736953</p> <p>501.31509 1736954</p> <p style="text-align: right;">DX RH SX LH</p>
	<p>BRACCIO SPECCHIO CORTO BRACCIO CORTO 100 MIRROR BRACKET SHORT SHORT ARM 100 COS.PEL. ref. SIMILAR ref. 501.31512 1733893</p> <p>501.31511 1733892</p> <p style="text-align: right;">DX RH SX LH</p>
	<p>SPECCHIO RETROVISORE MANUALE - RISCALDATO REAR-VIEW MIRROR MANUAL - HEATED COS.PEL. ref. SIMILAR ref. 501.53500 1404871 / 1405295 / 1805712 DX-SX RH-LH</p>
	<p>SPECCHIO RETROVISORE MANUALE - RISCALDATO REAR-VIEW MIRROR MANUAL - HEATED COS.PEL. ref. SIMILAR ref. 501.53501 1796324 DX-SX RH-LH</p>
 <p>cm 189,5 cm 30 cm 74 cm 74</p>	<p>VISIERA TETTO BASSO CON SPECCHIO FRONTALE LOW ROOF SUN VISOR WITH FRONT MIRROR COS.PEL. ref. SIMILAR ref. 704.55100 1742638 Relativo kit staffe : 1004.55100</p>
	<p>VISIERA TETTO BASSO SENZA SPECCHIO FRONTALE LOW ROOF SUN VISOR WITHOUT FRONT MIRROR COS.PEL. ref. SIMILAR ref. 704.55101 1405233 / 1742640 Relativo kit staffe 1004.55101</p>









	<p>CONVOGLIATORE ARIA A.B.S. - BIANCO AIR CONVEYOR A.B.S. - WHITE COS.PEL. ref. SIMILAR ref. 904.55180 1400711 / 1405231 DX RH</p> <p>904.55181 1400710 / 1405230 SX LH</p>
	<p>GRIGLIA PEDANA INFERIORE ALLUMINIO LOWER FOOTSTEP ALUMINIUM COS.PEL. ref. SIMILAR ref. 1004.55000 1405241 DX-SX RH-LH</p>
	<p>GRIGLIA PEDANA FOOTSTEP COS.PEL. ref. SIMILAR ref. 1004.55001 1404308</p>
	<p>SUPPORTO PARAURTI BUMPER BRACKET COS.PEL. ref. SIMILAR ref. 1004.55002 1401819 DX RH</p> <p>1004.55003 1401818 SX LH</p>
	<p>SUPPORTO FARO ALLUMINIO LAMP BRACKET ALUMINIUM COS.PEL. ref. SIMILAR ref. 1104.55060 1400505 / 1407464 DX RH</p> <p>1104.55061 1400504 / 1407465 SX LH</p>
 	<p>FANALE LATERALE LAMPADINA ATTACCO AMP - JPT - Relativo connettore 003122 SIDE LAMP BULB CONNECTION AMP - JPT - Related connector 003122 COS.PEL. ref. SIMILAR ref. 003001 1303892 / 1329718 DX-SX RH-LH</p> <p>ARANCIO / ORANGE - Relativo portalampada 1601.50013</p>
	<p>PORTALAMPADA Relativo connettore 003122 (JPT) LAMP BULB HOLDER Related connector 003122 (JPT) COS.PEL. ref. SIMILAR ref. 1601.50013 1608352</p> <p>Per lampada / For lamp : 003001 / 003003 / 003004</p>
	<p>PORTALAMPADA Relativo connettore 003121 LAMP BULB HOLDER Related connector 003121 COS.PEL. ref. SIMILAR ref. 1601.50015 1626102</p> <p>Per lampada / For lamp : 1601.50018 / 1604.55001</p>

 	<p>FANALINO LATERALE R5W CORNER LAMP R5W</p> <p>COS.PEL. ref. 1604.55001 SIMILAR ref. 1626101</p> <p style="text-align: right;">DX-SX RH-LH</p> <p style="text-align: right;">Relativo portalampada/Lamp holder : 1601.50015</p>
	<p>MANIGLIA PORTA SENZA CHIAVE DOOR HANDLE WITHOUT KEY</p> <p>COS.PEL. ref. 1701.53600 SIMILAR ref. 1400778 / 1406622</p> <p style="text-align: right;">DX RH</p> <p>1701.53601 1400769 / 1407256</p> <p style="text-align: right;">SX LH</p>
	<p>SERRATURA PORTA DOOR LOCK</p> <p>COS.PEL. ref. 1704.55700 SIMILAR ref. 1406624</p> <p style="text-align: right;">DX RH</p> <p>1704.55701 1406623</p> <p style="text-align: right;">SX LH</p>
	<p>ALZACRISTALLI ELETTRICO - CON MOTORINO - 2 PIN WINDOW REGULATOR ELECTRIC - WITH MOTOR - 2 PIN</p> <p>COS.PEL. ref. 1904.55550 SIMILAR ref. 1400754 / 1406666 / 1705699 / 1707357 / 1714810</p> <p style="text-align: right;">DX RH</p> <p>1904.55551 1400753 / 1406665 / 1705698 / 1707356 / 1714809</p> <p style="text-align: right;">SX LH</p>
	<p>MOLLA A GAS Lunghezza [mm] 615 Corsa [mm] 260 Forza scarto [N] 215 GAS SPRING Lenght [mm] 615 Stroke [mm] 260 Waste force [N] 215</p> <p>COS.PEL. ref. 2404.55100 SIMILAR ref. 1400705</p>
	<p>KIT PER CONNESSIONI ELETTRICHE Connettore AMP 1,5 singolo KIT FOR ELECTRICAL JOINTS Connector AMP 1,5 simple</p> <p>COS.PEL. ref. 003120 SIMILAR ref. -</p>
	<p>KIT PER CONNESSIONI ELETTRICHE Connettore 3 vie JPT KIT FOR ELECTRICAL JOINTS Connector 3 ways JPT</p> <p>COS.PEL. ref. 003121 SIMILAR ref. -</p> <p style="text-align: right;">Connettore per 1601.50015</p>
	<p>KIT PER CONNESSIONI ELETTRICHE Connettore 2 vie JPT KIT FOR ELECTRICAL JOINTS Connector 2 ways JPT</p> <p>COS.PEL. ref. 003122 SIMILAR ref. -</p> <p style="text-align: right;">Connettore per 003001 - 003003 - 003004</p>

 <p>mm 15,2</p>	<p>FANALE POSTERIORE REAR-LIGHT</p> <p>COS.PEL. ref. 1501.03000 SIMILAR ref. 1401731 (ex 007880/007900) - Connettore 003120</p> <p>1501.03001 1401713 Con luce targa / W. plate light (ex 007880/007900) - Conn. 003120</p> <p>TRASPARENTE / LENS 1501.03100 1451482 (ex 011591)</p> <p>5 FUNZIONI - CONNETTORE POSTERIORE AMP 1.5 5 FUNCTIONS - REAR CONNECTOR AMP 1.5</p> <p>DX RH SX LH DX-SX RH-LH</p>
--	--



	<p>GRIGLIA A.B.S. GRILLE A.B.S.</p> <p>COS.PEL. ref. SIMILAR ref. 104.56010 1707123</p>
	<p>FRONTALE S.M.C. FRONT PLATE S.M.C.</p> <p>COS.PEL. ref. SIMILAR ref. 104.56012 1706953</p>
	<p>PEDANA PARAFANGO S.M.C. - GRIGIO MUDGUARD FOOTSTEP S.M.C. - GREY</p> <p>COS.PEL. ref. SIMILAR ref. 204.55020 1405250 / 1408232 DX RH</p> <p>204.55021 1405247 / 1408227 SX LH</p> <p>Griglia/Grille : 1004.55001 Griglia/Grille : 1004.55001</p>
	<p>PARAURTI ANTERIORE SENZA FORI FENDI FRONT BUMPER WITHOUT FOG LAMP HOLES</p> <p>COS.PEL. ref. SIMILAR ref. 404.56099 1706972 / 1706976</p>
	<p>PARAURTI ANTERIORE CON FORI FENDI - METALLO - NERO FRONT BUMPER WITH HOLES FOG LAMP - STEEL - BLACK</p> <p>COS.PEL. ref. SIMILAR ref. 404.56100 1706904 / 1706973</p>









	<p>ANGOLO PARAU RTI S.M.C. CORNER BUMPER S.M.C. COS.PEL. ref. SIMILAR ref. 404.56102 1706987</p> <p>404.56101 1706986</p> <p style="text-align: right;">DX RH</p> <p style="text-align: right;">SX LH</p>
	<p>PEDANA PARAU RTI ALLUMINIO STEP PANEL ALUMINIUM COS.PEL. ref. SIMILAR ref. 404.56103 964275</p>
	<p>SPECCHIO RETROVISORE ELETTRICO - RISCALDATO - NERO - BRACCIO CORTO 100 REAR-VIEW MIRROR ELECTRIC - HEATED - BLACK - SHORT ARM 100 COS.PEL. ref. SIMILAR ref. 501.31506 1700306 / 1704604</p> <p>501.31505 1700303</p> <p style="text-align: right;">DX RH</p> <p style="text-align: right;">SX LH</p>
	<p>SPECCHIO RETROVISORE ELETTRICO - RISCALDATO - NERO - BRACCIO LUNGO 200 REAR-VIEW MIRROR ELECTRIC - HEATED - BLACK - LONG ARM 200 COS.PEL. ref. SIMILAR ref. 501.31508 1700269 / 1704605</p> <p>501.31507 1700265</p> <p style="text-align: right;">DX RH</p> <p style="text-align: right;">SX LH</p>
	<p>BRACCIO SPECCHIO LUNGO BRACCIO LUNGO 200 - FORNITO DI CAVI MIRROR BRACKET LONG LONG ARM 200 - WITH CABLES COS.PEL. ref. SIMILAR ref. 501.31510 1736953</p> <p>501.31509 1736954</p> <p style="text-align: right;">DX RH</p> <p style="text-align: right;">SX LH</p>
	<p>BRACCIO SPECCHIO CORTO BRACCIO CORTO 100 MIRROR BRACKET SHORT SHORT ARM 100 COS.PEL. ref. SIMILAR ref. 501.31512 1733893</p> <p>501.31511 1733892</p> <p style="text-align: right;">DX RH</p> <p style="text-align: right;">SX LH</p>
	<p>CONVOGLIATORE ARIA A.B.S. CORNER PANEL A.B.S. COS.PEL. ref. SIMILAR ref. 904.56170 1706920 / 1709694</p> <p>904.56171 1706919 / 1709693</p> <p style="text-align: right;">DX RH</p> <p style="text-align: right;">SX LH</p>
	<p>GRIGLIA PEDANA FOOTSTEP COS.PEL. ref. SIMILAR ref. 1004.55001 1404308</p>

LF Euro 6 PX5

	<p>CORNICE FARO P.P. - BIANCO HEADLAMP FRAME P.P. - WHITE COS.PEL. ref. SIMILAR ref. 1104.56030 1706985 DX RH</p> <p>1104.56031 1706984 SX LH</p>
	<p>SUPPORTO FARO ALLUMINIO HEADLAMP FRAME ALUMINIUM COS.PEL. ref. SIMILAR ref. 1104.56032 1707002 DX RH</p> <p>1104.56033 1707003 SX LH</p>
 	<p>FENDINEBBIA H11 FOG LAMP H11 COS.PEL. ref. SIMILAR ref. 1604.56600 1892912 / 2032706 DX RH</p> <p>1604.56601 1892911 / 2032705 SX LH</p>
 	<p>FENDINEBBIA CON SVOLTA ATTACCO LATERALE H11 FOG LAMP WITH SIDE CONNECTION H11 COS.PEL. ref. SIMILAR ref. 1604.56602 1892914 / 2032708 DX RH</p> <p>1604.56603 1892913 / 2032707 SX LH</p>
 	<p>PROIETTORE H7 H1 PY21W LED HEADLAMP H7 H1 PY21W LED COS.PEL. ref. SIMILAR ref. 1604.56604 1706997 / 1714559 DX RH</p> <p>1604.56605 1706996 / 1714558 SX LH</p>
	<p>ALZACRISTALLI ELETTRICO - CON MOTORINO - 2 PIN WINDOW REGULATOR ELECTRIC - WITH MOTOR - 2 PIN COS.PEL. ref. SIMILAR ref. 1904.55550 1400754 / 1406666 / 1705699 / 1707357 / 1714810 DX RH</p> <p>1904.55551 1400753 / 1406665 / 1705698 / 1707356 / 1714809 SX LH</p>



	<p>FRONTALE S.M.C. - GRIGIO FRONT PLATE S.M.C. - GREY</p> <p>COS.PEL. ref. SIMILAR ref. 104.56011 1706968 / 1706969</p>
	<p>PEDANA S.M.C. FOOTSTEP S.M.C.</p> <p>COS.PEL. ref. SIMILAR ref. 304.56050 1707006 / 1707973 DX RH</p> <p>304.56051 1707007 / 1708932 SX LH</p> <p>Griglia/Grille 1004.55000 Griglia/Grille 1004.55000</p>
	<p>PARAURTI ANTERIORE SENZA FORI FENDI FRONT BUMPER WITHOUT FOG LAMP HOLES</p> <p>COS.PEL. ref. SIMILAR ref. 404.56099 1706972 / 1706976</p>
	<p>PARAURTI ANTERIORE CON FORI FENDI - METALLO - NERO FRONT BUMPER WITH HOLES FOG LAMP - STEEL - BLACK</p> <p>COS.PEL. ref. SIMILAR ref. 404.56100 1706904 / 1706973</p>
	<p>ANGOLO PARAURTI S.M.C. CORNER BUMPER S.M.C.</p> <p>COS.PEL. ref. SIMILAR ref. 404.56102 1706987 DX RH</p> <p>404.56101 1706986 SX LH</p>

	<p>PEDANA PARAURTI ALLUMINIO STEP PANEL ALUMINIUM</p> <p>COS.PEL. ref. SIMILAR ref. 404.56103 964275</p>
	<p>SPECCHIO RETROVISORE ELETTRICO - RISCALDATO - NERO - BRACCIO CORTO 100 REAR-VIEW MIRROR ELECTRIC - HEATED - BLACK - SHORT ARM 100</p> <p>COS.PEL. ref. SIMILAR ref. 501.31506 1700306 / 1704604 DX RH</p> <p>501.31505 1700303 SX LH</p>
	<p>SPECCHIO RETROVISORE ELETTRICO - RISCALDATO - NERO - BRACCIO LUNGO 200 REAR-VIEW MIRROR ELECTRIC - HEATED - BLACK - LONG ARM 200</p> <p>COS.PEL. ref. SIMILAR ref. 501.31508 1700269 / 1704605 DX RH</p> <p>501.31507 1700265 SX LH</p>
	<p>BRACCIO SPECCHIO LUNGO BRACCIO LUNGO 200 - FORNITO DI CAVI MIRROR BRACKET LONG LONG ARM 200 - WITH CABLES</p> <p>COS.PEL. ref. SIMILAR ref. 501.31510 1736953 DX RH</p> <p>501.31509 1736954 SX LH</p>
	<p>BRACCIO SPECCHIO CORTO BRACCIO CORTO 100 MIRROR BRACKET SHORT SHORT ARM 100</p> <p>COS.PEL. ref. SIMILAR ref. 501.31512 1733893 DX RH</p> <p>501.31511 1733892 SX LH</p>
	<p>CONVOGLIATORE ARIA A.B.S. CORNER PANEL A.B.S.</p> <p>COS.PEL. ref. SIMILAR ref. 904.56170 1706920 / 1709694 DX RH</p> <p>904.56171 1706919 / 1709693 SX LH</p>
	<p>GRIGLIA PEDANA INFERIORE ALLUMINIO LOWER FOOTSTEP ALUMINIUM</p> <p>COS.PEL. ref. SIMILAR ref. 1004.55000 1405241 DX-SX RH-LH</p>
	<p>CORNICE FARO P.P. - BIANCO HEADLAMP FRAME P.P. - WHITE</p> <p>COS.PEL. ref. SIMILAR ref. 1104.56030 1706985 DX RH</p> <p>1104.56031 1706984 SX LH</p>

 	<p>FENDINEBBIA H11 FOG LAMP H11</p> <p>COS.PEL. ref. SIMILAR ref. 1604.56600 1892912 / 2032706 DX RH</p> <p>1604.56601 1892911 / 2032705 SX LH</p>
 	<p>FENDINEBBIA CON SVOLTA ATTACCO LATERALE H11 FOG LAMP WITH SIDE CONNECTION H11</p> <p>COS.PEL. ref. SIMILAR ref. 1604.56602 1892914 / 2032708 DX RH</p> <p>1604.56603 1892913 / 2032707 SX LH</p>
 	<p>PROIETTORE H7 H1 PY21W LED HEADLAMP H7 H1 PY21W LED</p> <p>COS.PEL. ref. SIMILAR ref. 1604.56604 1706997 / 1714559 DX RH</p> <p>1604.56605 1706996 / 1714558 SX LH</p>
	<p>ALZACRISTALLI ELETTRICO - CON MOTORINO - 2 PIN WINDOW REGULATOR ELECTRIC - WITH MOTOR - 2 PIN</p> <p>COS.PEL. ref. SIMILAR ref. 1904.55550 1400754 / 1406666 / 1705699 / 1707357 / 1714810 DX RH</p> <p>1904.55551 1400753 / 1406665 / 1705698 / 1707356 / 1714809 SX LH</p>



 <p>cm 67 cm 62,5 cm 23,5</p>	<p>PARAFANGO POSTERIORE LATERALE SENZA STAFFE P.P. - NERO REAR MUDGUARD WITHOUT BRACKETS P.P. - BLACK</p> <p>COS.PEL. ref. 204.28932 SIMILAR ref. 1328934</p> <p>(204.28934 versione con le staffe)</p>
 <p>cm 65 cm 100 cm 19,5</p>	<p>CALOTTA PARAFANGO POSTERIORE CON 4 TIRANTI P.P. - NERO REAR MUDGUARD WITH 4 MUDGUARD TENSIONERS P.P. - BLACK</p> <p>COS.PEL. ref. 204.28933 SIMILAR ref. 1328935 / 1340450 DX-SX RH-LH</p> <p>(204.28935 versione senza i tiranti)</p>
 <p>cm 67 cm 62,5 cm 23,5</p>	<p>MEZZO PARAFANGO POSTERIORE P.P. - NERO - CON STAFFE REAR MUDGUARD P.P. - BLACK - WITH BRACKETS</p> <p>COS.PEL. ref. 204.28934 SIMILAR ref. 1328934 DX-SX RH-LH</p> <p>(204.28932 versione senza staffe)</p>
 <p>cm 65 cm 100 cm 19,5</p>	<p>CALOTTA PARAFANGO POSTERIORE P.P. - NERO REAR MUDGUARD P.P. - BLACK</p> <p>COS.PEL. ref. 204.28935 SIMILAR ref. 1328935 DX-SX RH-LH</p> <p>Relativo tirante 1001.00001 - (204.28933 versione con i tiranti)</p>
	<p>PEDANA STRATIFICAZIONE MANUALE - BIANCO FOOTSTEP G.R.P. - WHITE</p> <p>COS.PEL. ref. 304.84096 SIMILAR ref. 084097 / 1297700 DX RH</p> <p>304.84097 084096 / 1297699 SX LH</p>

	<p>SOTTOPARAURTI STRATIFICAZIONE MANUALE - BIANCO SPOILER G.R.P. - WHITE</p> <p>COS.PEL. ref. SIMILAR ref. 404.46301 1246301</p>
	<p>COLLARE DI FISSAGGIO PARAFANGO METALLO BRACKET MUDGUARD METAL</p> <p>COS.PEL. ref. SIMILAR ref. 1006.33602 1649588</p>
	<p>MANIGLIA PORTA ANTERIORE ESTERNA CON CHIAVE FRONT DOOR HANDLE OUTSIDE WITH KEY</p> <p>COS.PEL. ref. SIMILAR ref. 1704.63700 1328725 / 1617041 / 1651635 DX RH</p> <p>1704.63701 1328724 / 1617040 / 1651634 SX LH</p>
	<p>TIRANTE PORTA DOOR CHECK</p> <p>COS.PEL. ref. SIMILAR ref. 1704.63702 1879827 DX-SX RH-LH</p>



	<p>GRIGLIA SUPERIORE S.M.C. UPPER GRILLE S.M.C.</p> <p>COS.PEL. ref. SIMILAR ref. 104.72534 1372534 / 1747244</p>
	<p>FRONTALE SUPERIORE S.M.C. UPPER FRONT PANEL S.M.C.</p> <p>COS.PEL. ref. SIMILAR ref. 104.72535 1372535</p>
	<p>GRIGLIA INFERIORE A.B.S. - NERO LOWER GRILLE A.B.S. - BLACK</p> <p>COS.PEL. ref. SIMILAR ref. 104.72536 1375876 / 1640320 / 1657685</p>
	<p>PEDANA PARAFANGO P.P.G.F. - GRIGIO MUDGUARD FOOTSTEP P.P.G.F. - GREY</p> <p>COS.PEL. ref. SIMILAR ref. 204.37810 1363817 / 1437810 / 1656918 / 1656977 / 1893902 DX RH 204.37809 Griglia/Grille : 1004.10028 1437809 / 1656917 / 1893901 SX LH</p> <p>Griglia/Grille : 1004.10028</p>
	<p>PARAFANGO POSTERIORE RUOTA ANTERIORE A.B.S. - NERO REAR MUDGUARD FRONT WHEEL A.B.S. - BLACK</p> <p>COS.PEL. ref. SIMILAR ref. 204.69438 1389297 / 1659254 DX RH 204.69437 1389296 / 1659253 SX LH</p>

 <p>cm 67 cm 62,5 cm 23,5</p>	<p>PARAFANGO POSTERIORE LATERALE SENZA STAFFE P.P. - NERO REAR MUDGUARD WITHOUT BRACKETS P.P. - BLACK</p> <p>COS.PEL. ref. SIMILAR ref. 204.28932 1328934</p> <p>(204.28934 versione con le staffe)</p>
 <p>cm 65 cm 100 cm 19,5</p>	<p>CALOTTA PARAFANGO POSTERIORE CON 4 TIRANTI P.P. - NERO REAR MUDGUARD WITH 4 MUDGUARD TENSIONERS P.P. - BLACK</p> <p>COS.PEL. ref. SIMILAR ref. 204.28933 1328935 / 1340450 DX-SX RH-LH</p> <p>(204.28935 versione senza i tiranti)</p>
 <p>cm 67 cm 62,5 cm 23,5</p>	<p>MEZZO PARAFANGO POSTERIORE P.P. - NERO - CON STAFFE REAR MUDGUARD P.P. - BLACK - WITH BRACKETS</p> <p>COS.PEL. ref. SIMILAR ref. 204.28934 1328934 DX-SX RH-LH</p> <p>(204.28932 versione senza staffe)</p>
 <p>cm 65 cm 100 cm 19,5</p>	<p>CALOTTA PARAFANGO POSTERIORE P.P. - NERO REAR MUDGUARD P.P. - BLACK</p> <p>COS.PEL. ref. SIMILAR ref. 204.28935 1328935 DX-SX RH-LH</p> <p>Relativo tirante 1001.00001 - (204.28933 versione con i tiranti)</p>
 <p>cm 58,5 cm 34,5</p>	<p>PEDANA 6X4 A.B.S. - GRIGIO FOOTSTEP 6X4 A.B.S. - GREY</p> <p>COS.PEL. ref. SIMILAR ref. 304.64100 1440245 DX RH</p> <p>304.64101 1440244 SX LH</p> <p>Griglia/Grille 1004.10022</p> <p>Griglia/Grille 1004.10022</p>
 <p>cm 60 cm 34</p>	<p>PEDANA A.B.S. - GRIGIO FOOTSTEP A.B.S. - GREY</p> <p>COS.PEL. ref. SIMILAR ref. 304.64796 1440243 DX RH</p> <p>304.64797 1440242 SX LH</p> <p>Griglia/Grille : 1004.10022</p> <p>Griglia/Grille : 1004.10022</p>
 <p>cm 60 cm 34</p>	<p>PEDANA A.B.S. - BIANCO FOOTSTEP A.B.S. - WHITE</p> <p>COS.PEL. ref. SIMILAR ref. 304.64798 1364799 / 1695229 / 1911155 DX RH</p> <p>304.64799 1364798 / 1695228 / 1911154 SX LH</p> <p>Griglia/Grille 1004.10022</p> <p>Griglia/Grille 1004.10022</p>
	<p>PARAURTI ANTERIORE METALLO FRONT BUMPER STEEL</p> <p>COS.PEL. ref. SIMILAR ref. 404.63375 1363375 / 1656562 / 1656563 / 1825005 / 1826226 / 1852685</p>

CF

COS.DA

	<p>SPECCHIO RETROVISORE MANUALE - RISCALDATO REAR-VIEW MIRROR MANUAL - HEATED</p> <p>COS.PEL. ref. SIMILAR ref. 501.53501 1796324</p> <p style="text-align: right;">DX-SX RH-LH</p>
	<p>VETRO SPECCHIO GRANDANGOLO - RISCALDATO - R/300 MIRROR GLASS WIDE ANGLE - HEATED - RADIUS/300</p> <p>COS.PEL. ref. SIMILAR ref. 501.89373 1610182 / 1610191</p> <p style="text-align: right;">DX RH</p>
	<p>SPECCHIO RETROVISORE ELETTRICO - RISCALDATO REAR-VIEW MIRROR ELECTRIC - HEATED</p> <p>COS.PEL. ref. SIMILAR ref. 504.10530 1689348 / 1812862</p> <p style="text-align: right;">DX-SX RH-LH</p>
	<p>SPECCHIO RETROVISORE GRANDANGOLO - ELETTRICO - RISCALDATO - RAGGIO 300 REAR-VIEW MIRROR WIDE ANGLE - ELECTRIC - HEATED - RADIUS 300</p> <p>COS.PEL. ref. SIMILAR ref. 504.10531 1689347 / 1817860</p> <p style="text-align: right;">DX-SX RH-LH</p>
	<p>SPECCHIO RETROVISORE ELETTRICO - RISCALDATO REAR-VIEW MIRROR ELECTRIC - HEATED</p> <p>COS.PEL. ref. SIMILAR ref. 504.63500 1952146</p> <p style="text-align: right;">DX RH</p> <p>504.63501 1952141</p> <p style="text-align: right;">SX LH</p>
	<p>SPECCHIO GUARDARUOTA RAGGIO 300 ROOF MIRROR RADIUS 300</p> <p>COS.PEL. ref. SIMILAR ref. 504.72500 1614021 / 1949304</p>
	<p>VETRO SPECCHIO RISCALDATO - (370x190mm) MIRROR GLASS HEATED - (370x190mm)</p> <p>COS.PEL. ref. SIMILAR ref. 504.99026 1610190</p> <p style="text-align: right;">DX-SX RH-LH</p>
	<p>SPECCHIO RETROVISORE ELETTRICO - RISCALDATO - (BRACCIO 28mm) REAR-VIEW MIRROR ELECTRIC - HEATED - (ARM 28mm)</p> <p>COS.PEL. ref. SIMILAR ref. 504.99027 1610184</p> <p style="text-align: right;">DX-SX RH-LH</p>



	<p>SPECCHIO RETROVISORE GRANDANGOLO - RISCALDATO - (BRACCIO 28mm) REAR-VIEW MIRROR WIDE ANGLE - HEATED - (ARM 28mm)</p> <p>COS.PEL. ref. SIMILAR ref. 504.99028 1610187 / 1670877</p> <p style="text-align: right;">DX-SX RH-LH</p>
	<p>VISIERA TETTO BASSO SUN VISOR</p> <p>COS.PEL. ref. SIMILAR ref. 704.63400 1298974 / 1312864 / 1312868</p> <p style="text-align: right;">Relativo kit staffe 1004.63400</p>
	<p>CONVOGLIATORE ARIA INTERNO R.T.M. - BIANCO INNER CORNER PANEL R.T.M. - WHITE</p> <p>COS.PEL. ref. SIMILAR ref. 904.72000 1372533</p> <p style="text-align: right;">DX RH</p> <p>904.72001 1372532 SX LH</p>
	<p>CONVOGLIATORE ARIA A.B.S. - BIANCO AIR CONVEYOR A.B.S. - WHITE</p> <p>COS.PEL. ref. SIMILAR ref. 904.72002 1362871</p> <p style="text-align: right;">DX RH</p> <p>904.72003 1362870 SX LH</p>
	<p>COPRI BATTERIE BATTERY COVER</p> <p>COS.PEL. ref. SIMILAR ref. 1004.10019 1667885 / 1693114</p>
	<p>SUPPORTO PEDANA SALITA ALLUMINIO FOOTSTEP BRACKET ALUMINIUM</p> <p>COS.PEL. ref. SIMILAR ref. 1004.10020 1366254 / 1368837 / 1638481</p> <p style="text-align: right;">DX RH</p> <p>1004.10021 1366253 / 1368836 / 1638480 SX LH</p>
	<p>GRIGLIA PEDANA INFERIORE ALLUMINIO LOWER FOOTSTEP GRILLE ALUMINIUM</p> <p>COS.PEL. ref. SIMILAR ref. 1004.10022 0962101</p> <p style="text-align: right;">DX-SX RH-LH</p>
	<p>SUPPORTO PARAURTI LATERALE METALLO BUMPER BRACKET STEEL</p> <p>COS.PEL. ref. SIMILAR ref. 1004.10024 1399185 / 1627646</p> <p style="text-align: right;">DX RH</p> <p>1004.10025 1399833 / 1627643 SX LH</p>

CF









COS.DA

	<p>SUPPORTO PARAURTI CENTRALE METALLO CENTRAL BUMPER BRACKET STEEL COS.PEL. ref. SIMILAR ref. 1004.10026 1438577 / 1696663 / 1699473 DX RH</p> <p>1004.10027 1438576 / 1696660 / 1696662 / 1699472 SX LH</p>
	<p>GRIGLIA PEDANA SUPERIORE UPPER FOOTSTEP GRILLE COS.PEL. ref. SIMILAR ref. 1004.10028 0750899</p>
	<p>COPRI BATTERIE BATTERY COVER COS.PEL. ref. SIMILAR ref. 1004.10555 1603386 / 1732653 / 1745335</p>
	<p>COLLARE DI FISSAGGIO PARAFANGO METALLO BRACKET MUDGUARD METAL COS.PEL. ref. SIMILAR ref. 1006.33602 1649588</p>
 <p>cm 42 cm 66</p>	<p>CORNICE FARO A.B.S. - BIANCO HEADLAMP FRAME A.B.S. - WHITE COS.PEL. ref. SIMILAR ref. 1104.63374 1363374 / 1658382 DX RH</p> <p>1104.63373 1363373 SX LH</p>
	<p>SUPPORTO FARO ALLUMINIO LAMP BRACKET ALUMINIUM COS.PEL. ref. SIMILAR ref. 1104.63376 1372802 DX RH</p> <p>1104.63375 1372801 SX LH</p>
 <p>cm 42 cm 66</p>	<p>CORNICE FARO A.B.S. - PRIMER HEADLAMP FRAME A.B.S. - PRIMER COS.PEL. ref. SIMILAR ref. 1104.63378 1435755 / 1658384 DX RH</p> <p>1104.63377 1435754 / 1658383 SX LH</p>
<p>AD ESAURIMENTO SCORTE UNTIL SELL OUT</p> 	<p>PORTA METALLO DOOR STEEL COS.PEL. ref. SIMILAR ref. 1404.95612 1450156 / 1836600 / 1940527 DX RH</p> <p>1404.95611 1450155 / 1836599 SX LH</p>

	<p>SOTTOPORTA BIANCO DOOR EXTENSION WHITE COS.PEL. ref. SIMILAR ref. 1404.95614 - DX RH</p> <p>1404.95613 - SX LH</p>
 	<p>FANALE LATERALE LAMPADINA ATTACCO AMP - JPT - Relativo connettore 003122 SIDE LAMP BULB CONNECTION AMP - JPT - Related connector 003122 COS.PEL. ref. SIMILAR ref. 003001 1303892 / 1329718 DX-SX RH-LH</p> <p>ARANCIO / ORANGE - Relativo portalamпада 1601.50013</p>
	<p>FANALE LATERALE LAMPADINA ATTACCO AMP-JPT - W5W - Relativo connettore 003122 SIDE LAMP BULB CONNECTION AMP-JPT - W5W - Relativo connettore 003122 COS.PEL. ref. SIMILAR ref. 003003 1653605 DX-SX RH-LH</p> <p>BIANCO / WHITE - Relativo portalamпада 1601.50013</p>
	<p>PORTALAMPADA Relativo connettore 003122 (JPT) LAMP BULB HOLDER Related connector 003122 (JPT) COS.PEL. ref. SIMILAR ref. 1601.50013 1608352</p> <p>Per lampada / For lamp : 003001 / 003003 / 003004</p>
 	<p>FANALINO LATERALE P21W CORNER LAMP P21W COS.PEL. ref. SIMILAR ref. 1604.10588 1395361 / 1735355 / 1814096 DX-SX RH-LH</p>
 	<p>PROIETTORE H7 H1 P21W W5W - CORRETTORE ASSETTO MANUALE HEADLAMP H7 H1 P21W W5W - MANUAL LOAD LEVEL ADJUSTEMENT COS.PEL. ref. SIMILAR ref. 1604.10580 1641743 / 1699301 / 1743685 DX RH</p> <p>1604.10581 1641742 / 1699300 / 1743684 SX LH</p>
 	<p>PROIETTORE XENON SENZA CENTRALINA D2S H1 PY21W W5W - PREDISPOSTO PER CORRETTORE ASSETTO HEADLAMP XENON W/O CONTROL UNIT D2S H1 PY21W W5W - SUITABLE FOR LOAD LEVEL ADJUSTEMENT COS.PEL. ref. SIMILAR ref. 1604.10590 1636911 / 1699933 / 1743691 DX RH</p> <p>1604.10589 1699932 / 1743690 SX LH</p>
 	<p>FENDINEBBIA H3 H3 FOG LAMP H3 H3 COS.PEL. ref. SIMILAR ref. 1604.72500 1660963 / 1725273 DX RH</p> <p>1604.72501 1660962 / 1725272 SX LH</p>

CF

COS.DA

	<p>MANIGLIA PORTA ANTERIORE ESTERNA CON CHIAVE FRONT DOOR HANDLE OUTSIDE WITH KEY</p> <p>COS.PEL. ref. SIMILAR ref. 1704.63700 1328725 / 1617041 / 1651635</p> <p>1704.63701 1328724 / 1617040 / 1651634</p> <p style="text-align: right;">DX RH</p> <p style="text-align: right;">SX LH</p>
	<p>TIRANTE PORTA DOOR CHECK</p> <p>COS.PEL. ref. SIMILAR ref. 1704.63702 1879827</p> <p style="text-align: right;">DX-SX RH-LH</p>
	<p>ALZACRISTALLI ELETTRICO - CON MOTORINO - 2 FILI WINDOW REGULATOR ELECTRIC - WITH MOTOR - 2 WIRES</p> <p>COS.PEL. ref. SIMILAR ref. 1904.72750 1374569</p> <p>1904.72751 1374568</p> <p style="text-align: right;">DX RH</p> <p style="text-align: right;">SX LH</p>
	<p>ALZACRISTALLI ELETTRICO - SENZA MOTORINO WINDOW REGULATOR ELECTRIC - WITHOUT MOTOR</p> <p>COS.PEL. ref. SIMILAR ref. 1904.72752 1918144 / 2130641</p> <p>1904.72753 1918143 / 2130640</p> <p style="text-align: right;">DX RH</p> <p style="text-align: right;">SX LH</p>
	<p>ALZACRISTALLI ELETTRICO - CON MOTORINO - 24 V - MOTORE COMFORT - 6 PIN WINDOW REGULATOR ELECTRIC - WITH MOTOR - 24 V - 6 PIN</p> <p>COS.PEL. ref. SIMILAR ref. 1904.72754 1779728 / 2148562</p> <p>1904.72755 1779727 / 2148561</p> <p style="text-align: right;">DX RH</p> <p style="text-align: right;">SX LH</p>
	<p>VASCHETTA ESPANSIONE EXPANSION TANK</p> <p>COS.PEL. ref. SIMILAR ref. 2104.85080 1371329 / 1660859 / 1871493</p>
	<p>TIRANTE PARAFANGO POSTERIORE GOMMA - NERO MUDGUARD TENSIONER RUBBER - BLACK</p> <p>COS.PEL. ref. SIMILAR ref. 1001.00001 1340450</p>
	<p>MOLLA A GAS Lunghezza [mm] 671 Corsa [mm] 284 Forza scarto [N] 240 GAS SPRING Lenght [mm] 671 Stroke [mm] 284 Waste force [N] 240</p> <p>COS.PEL. ref. SIMILAR ref. 2404.63100 1372540</p>

	<p>DEFLETTORI LATERALI CON FASCIA ADESIVA SIDEWINDOW DEFLECTORS WITH ADHESIVE TAPE</p> <p>COS.PEL. ref. SIMILAR ref. 3004.00000 1234554 / 1649918</p>
	<p>KIT PER CONNESSIONI ELETTRICHE Connettore AMP 1,5 singolo KIT FOR ELECTRICAL JOINTS Connector AMP 1,5 simple</p> <p>COS.PEL. ref. SIMILAR ref. 003120 -</p>
	<p>KIT PER CONNESSIONI ELETTRICHE Connettore 2 vie JPT KIT FOR ELECTRICAL JOINTS Connector 2 ways JPT</p> <p>COS.PEL. ref. SIMILAR ref. 003122 -</p> <p>Connettore per 003001 - 003003 - 003004</p>
	<p>KIT PER CONNESSIONI ELETTRICHE Connettore SUPERSEAL 2 vie femmina KIT FOR ELECTRICAL JOINTS Connector SUPERSEAL ways female</p> <p>COS.PEL. ref. SIMILAR ref. 003123 -</p> <p>Connettore per la serie 1500.xxxxx</p>
 <p>15,2 cm</p>	<p>FANALE POSTERIORE LED - 24V - CONNETTORE POSTERIORE AMP 1.5 REAR-LIGHT LED - 24V - REAR CONNECTOR AMP 1.5</p> <p>COS.PEL. ref. SIMILAR ref. 1500.00000 - 1500.00001 -</p> <p>Relativo connettore multipolare 003120 DX RH Relativo connettore multipolare 003120 SX LH</p> <p>TRASPARENTE / LENS</p>
 <p>cm 15,2</p>	<p>FANALE POSTERIORE 5 FUNZIONI - CONNETTORE POSTERIORE AMP 1.5 REAR-LIGHT 5 FUNCTIONS - REAR CONNECTOR AMP 1.5</p> <p>COS.PEL. ref. SIMILAR ref. 1501.03000 1401731 (ex 007880/007900) - Connettore 003120 DX RH 1501.03001 1401713 Con luce targa / W. plate light (ex 007880/007900) - Conn. 003120 SX LH TRASPARENTE / LENS 1501.03100 1451482 (ex 011591) DX-SX RH-LH</p>

CF Euro 6





	<p>SUPPORTO GRIGLIA ALLUMINIO GRILLE BRACKET ALUMINIUM</p> <p>COS.PEL. ref. SIMILAR ref. 104.10602 1857654</p> <p>104.10601 1857653</p> <p style="text-align: right;">DX RH SX LH</p>
	<p>GRIGLIA A.B.S. GRILLE A.B.S.</p> <p>COS.PEL. ref. SIMILAR ref. 104.64100 1886592 / 2046503</p>
	<p>FRONTALE SUPERIORE UPPER GRILLE</p> <p>COS.PEL. ref. SIMILAR ref. 104.64101 1877261 / 1956193</p>
	<p>FRONTALE GRILLE</p> <p>COS.PEL. ref. SIMILAR ref. 104.64102 1893917 / 2144204</p>
	<p>CALOTTA PARAFANGO POSTERIORE CON 4 TIRANTI P.P. - NERO REAR MUDGUARD WITH 4 MUDGUARD TENSIONERS P.P. - BLACK</p> <p>COS.PEL. ref. SIMILAR ref. 204.10529 1875551 / 1875552 / 1927847 DX-SX RH-LH</p> <p>(204.10530 versione senza i tiranti)</p>

	<p>CALOTTA PARAFANGO POSTERIORE P.P. - NERO REAR MUDGUARD P.P. - BLACK</p> <p>COS.PEL. ref. SIMILAR ref. 204.10530 1875551 / 1875552 DX-SX RH-LH</p> <p>Relativo tirante 1004.10530 - (204.10529 versione con i tiranti)</p>
	<p>MEZZO PARAFANGO POST. PARTE POST. CON STAFFE P.P. - NERO - SENZA ANTISPRAY REAR MUDGUARD REAR PART WITH BRACKETS P.P. - BLACK - W/O ANTISPRAY</p> <p>COS.PEL. ref. SIMILAR ref. 204.10532 1875554 / 2120352 / 1875564 / 2120360 / 1892198 / 2120362 / 1936302 Antispray DX RH Staffe/brackets : 1004.10531 204.10531 1875553 / 2120351 / 1875563 / 2120359 / 1892197 / 2120361 / 1936302 Antispray SX LH Staffe/brackets : 1004.10531</p>
	<p>MEZZO PARAFANGO POST. PARTE ANT. CON STAFFE P.P. - NERO - CON STAFFE (cod. 1004.10533) REAR MUDGUARD FRONT PART WITH BRACKETS P.P. - BLACK - WITH BRACKETS (ref. 1004.10533)</p> <p>COS.PEL. ref. SIMILAR ref. 204.10534 1875550 DX RH</p> <p>204.10533 1875549 SX LH</p>
	<p>CALOTTA PROTETTIVA P.P. - NERO PROTECTIVE COVER P.P. - BLACK</p> <p>COS.PEL. ref. SIMILAR ref. 204.10535 1875567 DX-SX RH-LH</p>
	<p>MEZZO PARAFANGO POST. PARTE ANT. CON STAFFE P.P. - NERO - CON STAFFE REAR MUDGUARD FRONT PART WITH BRACKETS P.P. - BLACK - WITH BRACKET</p> <p>COS.PEL. ref. SIMILAR ref. 204.10536 1892246 DX RH</p> <p>204.10537 1892245 SX LH</p> <p>Relative staffe 1004.10531 Relative staffe 1004.10531</p>
	<p>PARASPRUZZI REAR MUDGUARD FLAP</p> <p>COS.PEL. ref. SIMILAR ref. 204.10540 1936302 DX-SX RH-LH</p>
	<p>MEZZO PARAFANGO POST. (PARTE ANTERIORE) P.P. - NERO - CON STAFFE REAR MUDGUARD (FRONT PART) P.P. - BLACK - WITH BRACKET</p> <p>COS.PEL. ref. SIMILAR ref. 204.10541 1892248 DX-SX RH-LH</p> <p>Relative staffe : 1004.10531</p>
	<p>PEDANA A.B.S. FOOTSTEP A.B.S.</p> <p>COS.PEL. ref. SIMILAR ref. 304.64200 1881345 / 1952792 DX RH</p> <p>304.64201 1881344 / 1952791 SX LH</p>

CF Euro 6

	<p>COPERCHIO PEDANA A.B.S. FOOTSTEP COVER A.B.S.</p> <p>COS.PEL. ref. SIMILAR ref. 304.64202 1881347</p> <p>DX RH</p> <p>304.64203 1881346</p> <p>SX LH</p>
	<p>PARAURTI ANTERIORE METALLO FRONT BUMPER STEEL</p> <p>COS.PEL. ref. SIMILAR ref. 404.64090 1876631 / 1933253</p>
	<p>SPECCHIO RETROVISORE ELETTRICO - RISCALDATO REAR-VIEW MIRROR ELECTRIC - HEATED</p> <p>COS.PEL. ref. SIMILAR ref. 504.10530 1689348 / 1812862</p> <p>DX-SX RH-LH</p>
	<p>SPECCHIO RETROVISORE GRANDANGOLO - ELETTRICO - RISCALDATO - RAGGIO 300 REAR-VIEW MIRROR WIDE ANGLE - ELECTRIC - HEATED - RADIUS 300</p> <p>COS.PEL. ref. SIMILAR ref. 504.10531 1689347 / 1817860</p> <p>DX-SX RH-LH</p>
	<p>SPECCHIO RETROVISORE ELETTRICO - RISCALDATO - GRANDANGOLO REAR-VIEW MIRROR ELECTRIC - HEATED - WIDE ANGLE</p> <p>COS.PEL. ref. SIMILAR ref. 504.10630 1940341</p>
	<p>CONVOGLIATORE ARIA CORNER PANEL</p> <p>COS.PEL. ref. SIMILAR ref. 904.64080 1844276</p> <p>DX RH</p> <p>904.64081 1844275</p> <p>SX LH</p>
	<p>SUPPORTO PARAURTI BUMPER BRACKET</p> <p>COS.PEL. ref. SIMILAR ref. 1004.10654 1895878 / 1922986</p> <p>DX RH</p> <p>1004.10655 1895877 / 1922985</p> <p>SX LH</p>
	<p>SUPPORTO FENDINEBBIA METALLO FOG LAMP HOUSING STEEL</p> <p>COS.PEL. ref. SIMILAR ref. 1104.64604 1837655</p> <p>DX RH</p> <p>1104.64605 1837654</p> <p>SX LH</p>

	<p>GUARNIZIONE CORNICE FARO GOMMA GASKET RUBBER COS.PEL. ref. SIMILAR ref. 1104.64606 1887135 DX RH</p> <p>1104.64607 1887134 SX LH</p>
	<p>CORNICE FARO A.B.S. HEADLAMP FRAME A.B.S. COS.PEL. ref. SIMILAR ref. 1104.64600 1881351 DX RH</p> <p>1104.64601 1881350 SX LH</p>
	<p>CORNICE FARO A.B.S. HEADLAMP FRAME A.B.S. COS.PEL. ref. SIMILAR ref. 1104.64602 1848558 DX RH</p> <p>1104.64603 1848557 SX LH</p>
	<p>SUPPORTO FARO ALLUMINIO LAMP BRACKET ALUMINIUM COS.PEL. ref. SIMILAR ref. 1104.64608 1837642 DX RH</p> <p>1104.64609 1837641 SX LH</p>
 	<p>LUCE DI DIREZIONE P21YW SIDE LAMP P21YW COS.PEL. ref. SIMILAR ref. 1604.10604 1846492 DX RH</p> <p>1604.10605 1846491 SX LH</p> <p>Portalampada / Bulb holder : 1606.92810</p> <p>Portalampada / Bulb holder : 1606.92810</p>
 	<p>PROIETTORE SENZA CENTRALINA H7 H1 PY21W - LED - MANUALE / ELETTRICO HEADLAMP W/O CONTROL UNIT H7 H1 PY21W - LED - MANUAL / ELECTRIC COS.PEL. ref. SIMILAR ref. 1604.10600 1835875 DX RH</p> <p>1604.10601 1835874 SX LH</p>
 	<p>PROIETTORE SENZA CENTRALINA FULL LED - H1 PY21W 2 LED - MANUALE / ELETTRICO HEADLAMP W/O CONTROL UNIT FULL LED - H1 PY21W 2 LED - MANUAL / ELECTRIC COS.PEL. ref. SIMILAR ref. 1604.10606 1857527 DX RH</p> <p>1604.10607 1857526 SX LH</p>
 	<p>FENDINEBBIA H11 FOG LAMP H11 COS.PEL. ref. SIMILAR ref. 1604.56600 1892912 / 2032706 DX RH</p> <p>1604.56601 1892911 / 2032705 SX LH</p>

CF Euro 6

COS.DA









 	<p>FENDINEBBIA CON SVOLTA ATTACCO LATERALE H11 FOG LAMP WITH SIDE CONNECTION H11</p> <p>COS.PEL. ref. SIMILAR ref. 1604.56602 1892914 / 2032708 DX RH</p> <p>1604.56603 1892913 / 2032707 SX LH</p>
	<p>CICALINO DI RETROMARCIA LC8 destra Cicalino di retromarcia - 24V - 90db BUZZER LC8 right buzzer - 24V - 90db</p> <p>COS.PEL. ref. SIMILAR ref. 003092 1973239</p>
	<p>KIT PER CONNESSIONI ELETTRICHE Connettore HDSCS singolo KIT FOR ELECTRICAL JOINTS Connector HDSCS simple</p> <p>COS.PEL. ref. SIMILAR ref. 003119 -</p>
	<p>KIT PER CONNESSIONI ELETTRICHE Connettore SUPERSEAL 2 vie femmina KIT FOR ELECTRICAL JOINTS Connector SUPERSEAL ways female</p> <p>COS.PEL. ref. SIMILAR ref. 003123 -</p> <p>Connettore per la serie 1500.xxxxx</p>
 <p>15,2 cm</p>	<p>FANALE POSTERIORE LED - 24V - CONNETTORE POSTERIORE AMP 1.5 REAR-LIGHT LED - 24V - REAR CONNECTOR AMP 1.5</p> <p>COS.PEL. ref. SIMILAR ref. 1500.00000 - DX RH</p> <p>1500.00001 - Relativo connettore multipolare 003120 SX LH</p> <p>TRASPARENTE / LENS Relativo connettore multipolare 003120</p>
 <p>cm 16</p>	<p>FANALE POSTERIORE CONNETTORE LATERALE HDSCS REAR-LIGHT LATERAL CONNECTOR HDSCS</p> <p>COS.PEL. ref. SIMILAR ref. 1504.10600 1875576 DX RH</p> <p>1504.10601 1875577 (ex 001060) - Relativo connettore 003119 SX LH</p> <p>TRASPARENTE / LENS (ex 001061) Con luce targa / With plate light - Connettore 003119</p> <p>1504.10680 1914691 (ex 016000) DX RH</p> <p>1504.10681 1914690 (ex 016001) SX LH</p>
 <p>cm 16</p>	<p>FANALE POSTERIORE CONNETTORE LATERALE HDSCS REAR-LIGHT LATERAL CONNECTOR HDSCS</p> <p>COS.PEL. ref. SIMILAR ref. 1504.10602 1875578 DX RH</p> <p>(ex 001062) - Con cicalino / With buzzer - Connettore 003119</p> <p>TRASPARENTE / LENS</p> <p>1504.10680 1914691 (ex 016000) DX RH</p>
 <p>cm 16</p>	<p>FANALE POSTERIORE CONNETTORE POSTERIORE HDSCS REAR-LIGHT REAR CONNECTOR HDSCS</p> <p>COS.PEL. ref. SIMILAR ref. 1504.10604 1875579 DX RH</p> <p>1504.10603 1875580 Relativo connettore 003119 SX LH</p> <p>TRASPARENTE / LENS Con luce targa / With plate light - Relativo connettore 003119</p> <p>1504.10680 1914691 (ex 016000) DX RH</p> <p>1504.10681 1914690 (ex 016001) SX LH</p>

	FANALE POSTERIORE REAR-LIGHT		CONNETTORE POSTERIORE HDSCS REAR CONNECTOR HDSCS	
	COS.PEL. ref. 1504.10606	SIMILAR ref. 1875581 Con cicalino / With buzzer - Relativo connettore 003119		DX RH
	TRASPARENTE / LENS 1504.10680	1914691	(ex 016000)	DX RH



<p>AD ESAURIMENTO SCORTE UNTIL SELL-OUT</p> 	<p>GRIGLIA SUPERIORE STRATIFICAZIONE MANUALE - BIANCO UPPER GRILLE G.R.P. - WHITE</p> <p>COS.PEL. ref. SIMILAR ref. 104.80059 280059</p>
<p>AD ESAURIMENTO SCORTE UNTIL SELL-OUT</p> 	<p>PARAFANGO POSTERIORE R.T.M. - NERO REAR MUDGUARD R.T.M. - BLACK</p> <p>COS.PEL. ref. SIMILAR ref. 204.85488 085488 / 1227147 DX RH</p> <p>204.85487 085487 / 1227146 SX LH</p>
	<p>PARAFANGO POSTERIORE LATERALE SENZA STAFFE P.P. - NERO REAR MUDGUARD WITHOUT BRACKETS P.P. - BLACK</p> <p>COS.PEL. ref. SIMILAR ref. 204.28932 1328934</p> <p>(204.28934 versione con le staffe)</p>
	<p>CALOTTA PARAFANGO POSTERIORE CON 4 TIRANTI P.P. - NERO REAR MUDGUARD WITH 4 MUDGUARD TENSIONERS P.P. - BLACK</p> <p>COS.PEL. ref. SIMILAR ref. 204.28933 1328935 / 1340450 DX-SX RH-LH</p> <p>(204.28935 versione senza i tiranti)</p>
	<p>MEZZO PARAFANGO POSTERIORE P.P. - NERO - CON STAFFE REAR MUDGUARD P.P. - BLACK - WITH BRACKETS</p> <p>COS.PEL. ref. SIMILAR ref. 204.28934 1328934 DX-SX RH-LH</p> <p>(204.28932 versione senza staffe)</p>

	<p>CALOTTA PARAFANGO POSTERIORE P.P. - NERO REAR MUDGUARD P.P. - BLACK</p> <p>COS.PEL. ref. SIMILAR ref. 204.28935 1328935</p> <p style="text-align: right;">DX-SX RH-LH</p> <p>Relativo tirante 1001.00001 - (204.28933 versione con i tiranti)</p>
	<p>PEDANA S.M.C. - BIANCO FOOTSTEP S.M.C. - WHITE</p> <p>COS.PEL. ref. SIMILAR ref. 304.81150 081150</p> <p style="text-align: right;">DX RH</p> <p>304.81151 081140</p> <p style="text-align: right;">SX LH</p>
	<p>PARAURTI ANTERIORE P.A.6 G.F. - GRIGIO FRONT BUMPER P.A.6 G.F. - GREY</p> <p>COS.PEL. ref. SIMILAR ref. 404.85510 085510 / 085511</p>
	<p>ANGOLO PARAURTI S.M.C. - GRIGIO CORNER BUMPER S.M.C. - GREY</p> <p>COS.PEL. ref. SIMILAR ref. 404.96756 096756</p> <p style="text-align: right;">DX RH</p> <p>404.96755 096755</p> <p style="text-align: right;">SX LH</p>
	<p>SOTTOPARAURTI STRATIFICAZIONE MANUALE - BIANCO SPOILER G.R.P. - WHITE</p> <p>COS.PEL. ref. SIMILAR ref. 404.81110 081110</p>
	<p>VETRO SPECCHIO RISCALDATO - (376x190mm) MIRROR GLASS HEATED - (376x190mm)</p> <p>COS.PEL. ref. SIMILAR ref. 502.44444 1305462</p> <p style="text-align: right;">DX-SX RH-LH</p>
	<p>SPECCHIO RETOVISORE RISCALDATO REAR-VIEW MIRROR HEATED</p> <p>COS.PEL. ref. SIMILAR ref. 502.99011 1353295</p> <p style="text-align: right;">DX-SX RH-LH</p>
	<p>SPECCHIO RETOVISORE GRANDANGOLO - RISCALDATO REAR-VIEW MIRROR WIDE ANGLE - HEATED</p> <p>COS.PEL. ref. SIMILAR ref. 502.99013 1232015</p> <p style="text-align: right;">DX RH</p>

	<p>VETRO SPECCHIO GRANDANGOLO - RISCALDATO - (194x158mm) MIRROR GLASS WIDE ANGLE - HEATED - (194x158mm)</p> <p>COS.PEL. ref. SIMILAR ref. 502.99017 0699854</p> <p style="text-align: right;">DX RH</p>
	<p>CONVOGLIATORE ARIA INTERNO R.I.M. - GRIGIO INNER AIR CONVEYOR R.I.M. - GREY</p> <p>COS.PEL. ref. SIMILAR ref. 904.80062 1302984 / 280062</p> <p style="text-align: right;">DX RH</p> <p>904.80063 1302983 / 280063</p> <p style="text-align: right;">SX LH</p>
	<p>CONVOGLIATORE ARIA A.B.S. - NERO AIR CONVEYOR A.B.S. - BLACK</p> <p>COS.PEL. ref. SIMILAR ref. 904.99418 1299418</p> <p style="text-align: right;">DX RH</p> <p>904.99417 1299417</p> <p style="text-align: right;">SX LH</p>
	<p>COLLARE DI FISSAGGIO PARAFANGO METALLO BRACKET MUDGUARD METAL</p> <p>COS.PEL. ref. SIMILAR ref. 1006.33602 1649588</p>
	<p>CORNICE FARO S.M.C. - GRIGIO HEADLAMP FRAME S.M.C. - GREY</p> <p>COS.PEL. ref. SIMILAR ref. 1104.96758 096758</p> <p style="text-align: right;">DX RH</p> <p>1104.96757 096757</p> <p style="text-align: right;">SX LH</p>
	<p>SERRATURA PORTA LATO INTERNO INNER DOOR LOCK</p> <p>COS.PEL. ref. SIMILAR ref. 1704.10564 1296591</p> <p style="text-align: right;">DX RH</p> <p>1704.10565 1296590</p> <p style="text-align: right;">SX LH</p>
	<p>SERRATURA PORTA LATO ESTERNO OUTER DOOR LOCK</p> <p>COS.PEL. ref. SIMILAR ref. 1704.10566 0159150 / 2013730</p> <p style="text-align: right;">DX RH</p> <p>1704.10567 0159149 / 2013729</p> <p style="text-align: right;">SX LH</p>
	<p>TIRANTE PARAFANGO POSTERIORE GOMMA - NERO MUDGUARD TENSIONER RUBBER - BLACK</p> <p>COS.PEL. ref. SIMILAR ref. 1001.00001 1340450</p>

	<p>DEFLETTORI LATERALI CON CLIPS SIDEWINDOW DEFLECTORS WITH CLIPS</p> <p>COS.PEL. ref. SIMILAR ref. 3004.00001 -</p>
	<p>FANALE POSTERIORE 7 FUNZIONI REAR-LIGHT 7 FUNCTIONS</p> <p>COS.PEL. ref. SIMILAR ref. 005900 1284212 DX RH</p> <p>005910 1284211 SX LH</p> <p>TRASPARENTE / LENS Con luce targa / With plate light</p> <p>011111 1272653 DX-SX RH-LH</p>

XF 95 1aSerie XF 95 2aSerie

COS.DA



	<p>GRIGLIA SUPERIORE S.M.C. - NERO UPPER GRILLE S.M.C. - BLACK</p> <p>COS.PEL. ref. SIMILAR ref. 104.00004 1400004</p>
	<p>GRIGLIA SUPERIORE S.M.C. - NERO UPPER GRILLE S.M.C. - BLACK</p> <p>COS.PEL. ref. SIMILAR ref. 104.09400 1309400</p>
	<p>FRONTALE SUPERIORE S.M.C. - BIANCO UPPER FRONT PANEL S.M.C. - WHITE</p> <p>COS.PEL. ref. SIMILAR ref. 104.09401 1309401</p>
	<p>GRIGLIA INFERIORE A.B.S. - NERO LOWER GRILLE A.B.S. - BLACK</p> <p>COS.PEL. ref. SIMILAR ref. 104.12789 1312789</p>
	<p>PARAFANGO POSTERIORE RUOTA ANTERIORE A.B.S. - NERO REAR MUDGUARD FRONT WHEEL A.B.S. - BLACK</p> <p>COS.PEL. ref. SIMILAR ref. 204.69438 1389297 / 1659254 DX RH</p> <p>204.69437 1389296 / 1659253 SX LH</p>

XF 95 1aSerie XF 95 2aSerie

	<p>PEDANA PARAFANGO P.P.G.F. - GRIGIO MUDGUARD FOOTSTEP P.P.G.F. - GREY COS.PEL. ref. SIMILAR ref.</p> <p>204.91172 1291173 / 1656912 / 1656924 / 1809266 DX RH</p> <p>204.91173 1291172 / 1656911 / 1656923 / 1809265 SX LH</p> <p>Griglia/grille : 1004.00013 inf. / sup. 1004.00014 Griglia/grille : 1004.00013 inf. / 1004.00014 sup.</p>
	<p>MEZZO PARAFANGO POSTERIORE P.P. - NERO - CON STAFFE REAR MUDGUARD P.P. - BLACK - WITH BRACKETS</p> <p>COS.PEL. ref. SIMILAR ref.</p> <p>201.28252 1389563 DX-SX RH-LH</p>
	<p>PARAFANGO POSTERIORE LATERALE SENZA STAFFE P.P. - NERO REAR MUDGUARD WITHOUT BRACKETS P.P. - BLACK</p> <p>COS.PEL. ref. SIMILAR ref.</p> <p>204.28932 1328934</p> <p>(204.28934 versione con le staffe)</p>
	<p>CALOTTA PARAFANGO POSTERIORE CON 4 TIRANTI P.P. - NERO REAR MUDGUARD WITH 4 MUDGUARD TENSIONERS P.P. - BLACK</p> <p>COS.PEL. ref. SIMILAR ref.</p> <p>204.28933 1328935 / 1340450 DX-SX RH-LH</p> <p>(204.28935 versione senza i tiranti)</p>
	<p>MEZZO PARAFANGO POSTERIORE P.P. - NERO - CON STAFFE REAR MUDGUARD P.P. - BLACK - WITH BRACKETS</p> <p>COS.PEL. ref. SIMILAR ref.</p> <p>204.28934 1328934 DX-SX RH-LH</p> <p>(204.28932 versione senza staffe)</p>
	<p>CALOTTA PARAFANGO POSTERIORE P.P. - NERO REAR MUDGUARD P.P. - BLACK</p> <p>COS.PEL. ref. SIMILAR ref.</p> <p>204.28935 1328935 DX-SX RH-LH</p> <p>Relativo tirante 1001.00001 - (204.28933 versione con i tiranti)</p>
	<p>CALOTTA PARAFANGO POSTERIORE P.P. - NERO - RIBASSATA REAR MUDGUARD P.P. - BLACK</p> <p>COS.PEL. ref. SIMILAR ref.</p> <p>204.28936 1659811 DX-SX RH-LH</p> <p>Relativo tirante 1001.00001 - (204.28937 versione con i tiranti)</p>
	<p>CALOTTA PARAFANGO POSTERIORE CON 4 TIRANTI P.P. - NERO REAR MUDGUARD WITH 4 MUDGUARD TENSIONERS P.P. - BLACK</p> <p>COS.PEL. ref. SIMILAR ref.</p> <p>204.28937 1340450 / 1659811 DX-SX RH-LH</p> <p>(204.28936 versione senza i tiranti)</p>

XF 95 1aSerie XF 95 2aSerie

	<p>PEDANA A.B.S. - BIANCO FOOTSTEP A.B.S. - WHITE COS.PEL. ref. 304.95732 SIMILAR ref. 1295735</p> <p>304.95735 Griglia/Grille : 1004.00010 1295732 Griglia/Grille : 1004.00010</p> <p style="text-align: right;">DX RH SX LH</p>
	<p>PEDANA A.B.S. - BIANCO SMALTATO FOOTSTEP A.B.S. - WHITE ENEMALLED COS.PEL. ref. 304.95736 SIMILAR ref. -</p> <p>304.95737 Griglia : 1004.00010 - Griglia : 1004.00010</p> <p style="text-align: right;">DX RH SX LH</p>
	<p>TRAVERSA PARAURTI ANTERIORE METALLO BUMPER BRACKET STEEL COS.PEL. ref. 404.27140 SIMILAR ref. 1300041 / 1427140</p>
	<p>PARAURTI ANTERIORE METALLO FRONT BUMPER STEEL COS.PEL. ref. 404.90191 SIMILAR ref. 1290191</p>
	<p>PARAURTI ANTERIORE METALLO - BEIGE BRILLANTE FRONT BUMPER STEEL - BEIGE COS.PEL. ref. 404.95090 SIMILAR ref. -</p>
	<p>SOTTOPARAURTI STRATIFICAZIONE MANUALE - BIANCO SPOILER G.R.P. - WHITE COS.PEL. ref. 404.17126 SIMILAR ref. 1317126</p>
	<p>PEDANA PARAURTI ALLUMINIO FOOTSTEP FOR BUMPER ALUMINIUM COS.PEL. ref. 404.10541 SIMILAR ref. 0948779</p>
	<p>SPECCHIO RETROVISORE MANUALE - RISCALDATO REAR-VIEW MIRROR MANUAL - HEATED COS.PEL. ref. 501.53501 SIMILAR ref. 1796324</p> <p style="text-align: right;">DX-SX RH-LH</p>

XF 95 1aSerie XF 95 2aSerie

	<p>VETRO SPECCHIO GRANDANGOLO - RISCALDATO - R/300 MIRROR GLASS WIDE ANGLE - HEATED - RADIUS/300</p> <p>COS.PEL. ref. SIMILAR ref. 501.89373 1610182 / 1610191</p> <p style="text-align: right;">DX RH</p>
	<p>VETRO SPECCHIO RISCALDATO - (370x190mm) MIRROR GLASS HEATED - (370x190mm)</p> <p>COS.PEL. ref. SIMILAR ref. 504.99026 1610190</p> <p style="text-align: right;">DX-SX RH-LH</p>
	<p>SPECCHIO RETROVISORE ELETTRICO - RISCALDATO - (BRACCIO 28mm) REAR-VIEW MIRROR ELECTRIC - HEATED - (ARM 28mm)</p> <p>COS.PEL. ref. SIMILAR ref. 504.99027 1610184</p> <p style="text-align: right;">DX-SX RH-LH</p>
	<p>SPECCHIO RETROVISORE GRANDANGOLO - RISCALDATO - (BRACCIO 28mm) REAR-VIEW MIRROR WIDE ANGLE - HEATED - (ARM 28mm)</p> <p>COS.PEL. ref. SIMILAR ref. 504.99028 1610187 / 1670877</p> <p style="text-align: right;">DX-SX RH-LH</p>
<p>AD ESAURIMENTO SCORTE UNTIL SELL-OUT</p> 	<p>SPOILER REGOLABILE STRATIFICAZIONE MANUALE - BIANCO ADJUSTABLE SPOILER G.R.P. - WHITE</p> <p>COS.PEL. ref. SIMILAR ref. 604.00095 1311329</p>
 <p>cm 239,5 cm 23 cm 49,5 cm 61 cm 49,5</p>	<p>VISIERA TETTO BASSO TETTO BASSO SUN VISOR LOW CAB LOW CAB</p> <p>COS.PEL. ref. SIMILAR ref. 704.10500 1308687</p> <p style="text-align: right;">Relativo kit staffe 1004.10500 (oe 1311766)</p>
 <p>cm 239 cm 27 cm 53,5 cm 60,5 cm 53,5</p>	<p>VISIERA TETTO MEDIO TETTO MEDIO SUN VISOR MIDLUM CAB MIDLUM CAB</p> <p>COS.PEL. ref. SIMILAR ref. 704.10501 1300557</p> <p style="text-align: right;">Relativo kit staffe 1004.10501 (oe 1311765)</p>
 <p>cm 234,5 cm 20,5 cm 52,4 cm 52,4</p>	<p>VISIERA SUPER SPACE CAB SUN VISOR SUPER SPACE CAB</p> <p>COS.PEL. ref. SIMILAR ref. 704.10502 1651597</p> <p style="text-align: right;">Relativo kit staffe 1004.10502</p>

XF 95 1aSerie XF 95 2aSerie

	<p>RIVESTIMENTO SOTTOMOTORE STRATIFICAZIONE MANUALE - NERO ENGINE PROTECTION G.R.P. - BLACK</p> <p>COS.PEL. ref. 804.02007 SIMILAR ref. 1328945 / 1363278</p>
	<p>CONVOGLIATORE ARIA INTERNO 2a serie R.T.M. - GRIGIO INNER CORNER PANEL 2nd series R.T.M. - GREY</p> <p>COS.PEL. ref. 904.00012 SIMILAR ref. 1400012 DX RH</p> <p>904.00011 1400011 SX LH</p>
	<p>CONVOGLIATORE ARIA 2a serie A.B.S. - BIANCO AIR CONVEYOR 2nd series A.B.S. - WHITE</p> <p>COS.PEL. ref. 904.00014 SIMILAR ref. 1400014 DX RH</p> <p>904.00013 1400013 SX LH</p>
	<p>CONVOGLIATORE ARIA INTERNO R.I.M. - GRIGIO INNER AIR CONVEYOR R.I.M. - GREY</p> <p>COS.PEL. ref. 904.80062 SIMILAR ref. 1302984 / 280062 DX RH</p> <p>904.80063 1302983 / 280063 SX LH</p>
	<p>CONVOGLIATORE ARIA A.B.S. - NERO AIR CONVEYOR A.B.S. - BLACK</p> <p>COS.PEL. ref. 904.99418 SIMILAR ref. 1299418 DX RH</p> <p>904.99417 1299417 SX LH</p>
	<p>SUPPORTO PARAURTI PICCOLO METALLO BUMPER BRACKET STEEL</p> <p>COS.PEL. ref. 1004.00002 SIMILAR ref. 1319679 DX RH</p> <p>1004.00003 1319678 SX LH</p>
	<p>SUPPORTO PARAURTI METALLO BUMPER BRACKET STEEL</p> <p>COS.PEL. ref. 1004.00004 SIMILAR ref. 1329524 / 1450977 DX RH</p> <p>1004.00005 1329523 / 1450976 SX LH</p>
	<p>SUPPORTO PEDANA SALITA 1a SERIE - ALLUMINIO FOOTSTEP BRACKET 1st SERIES - ALUMINIUM</p> <p>COS.PEL. ref. 1004.00006 SIMILAR ref. 1303944 / 1347132 DX RH</p> <p>1004.00007 1303943 / 1347131 SX LH</p>

XF 95 1aSerie XF 95 2aSerie

	<p>SUPPORTO PEDANA SALITA 2a SERIE - ALLUMINIO FOOTSTEP BRACKET 2nd SERIES - ALUMINIUM COS.PEL. ref. SIMILAR ref. 1004.00008 1445564 / 1605933 DX RH</p> <p>1004.00009 1445563 / 1605932 SX LH</p>
	<p>GRIGLIA PEDANA INFERIORE ALLUMINIO LOWER FOOTSTEP GRILLE ALUMINIUM COS.PEL. ref. SIMILAR ref. 1004.00010 0962643 DX-SX RH-LH</p>
	<p>SUPPORTO PARAFANGO POSTERIORE ALLUMINIO REAR MUDGUARD BRACKET ALUMINIUM COS.PEL. ref. SIMILAR ref. 1004.00011 2050044 DX-SX RH-LH</p>
 <p style="text-align: center;">cm 61,5</p>	<p>TUBO SUPPORTO PARAFANGO CON GOMMINO DIRITTO - CM 61,5 - CON GOMMINO SUPPORT BRACKET WITH RUBBER STRAIGHT BRACKET - CM 61,5 - WITH RUBBER COS.PEL. ref. SIMILAR ref. 1004.00012 1610454 DX-SX RH-LH</p>
	<p>GRIGLIA PEDANA CENTRALE ALLUMINIO CENTRE FOOTSTEP GRILLE ALUMINIUM COS.PEL. ref. SIMILAR ref. 1004.00013 0673143 DX-SX RH-LH</p>
	<p>GRIGLIA PEDANA SUPERIORE ALLUMINIO UPPER FOOTSTEP GRILLE ALUMINIUM COS.PEL. ref. SIMILAR ref. 1004.00014 0673144 DX-SX RH-LH</p>
 <p style="text-align: center;">cm 61,5</p>	<p>TUBO SUPPORTO PARAFANGO CON GOMMINO PIEGATO - CM 61,5 - CON GOMMINO SUPPORT BRACKET WITH RUBBER BENT BRACKET - CM 61,5 - WITH RUBBER COS.PEL. ref. SIMILAR ref. 1004.00015 1629036 DX-SX RH-LH</p>
	<p>COLLARE DI FISSAGGIO METALLO BRACKET FOR MUDGUARD STEEL COS.PEL. ref. SIMILAR ref. 1004.00016 1629046</p>



XF 95 1aSerie XF 95 2aSerie

	<p>GOMMINO RUBBER</p> <p>COS.PEL. ref. SIMILAR ref. 1004.00017 1629045</p>
	<p>COPRI BATTERIE BATTERY COVER</p> <p>COS.PEL. ref. SIMILAR ref. 1004.10555 1603386 / 1732653 / 1745335</p>
	<p>COLLARE DI FISSAGGIO PARAFANGO METALLO BRACKET MUDGUARD METAL</p> <p>COS.PEL. ref. SIMILAR ref. 1006.33602 1649588</p>
	<p>SUPPORTO FARO 1a SERIE - ALLUMINIO LAMP BRACKET 1st SERIES - ALUMINIUM</p> <p>COS.PEL. ref. SIMILAR ref. 1104.99046 1308795 DX RH</p> <p>1104.99047 1308794 SX LH</p>
	<p>CORNICE FARO 1a SERIE - A.B.S. - BIANCO HEADLAMP FRAME 1st SERIES - A.B.S. - WHITE</p> <p>COS.PEL. ref. SIMILAR ref. 1104.99048 1294949 / 1911163 DX RH</p> <p>1104.99049 1294948 / 1911162 SX LH</p>
	<p>CORNICE FARO A.B.S. - BIANCO - 2a SERIE HEADLAMP FRAME A.B.S. - WHITE - 2nd SERIES</p> <p>COS.PEL. ref. SIMILAR ref. 1104.99050 1398285 / 1738627 DX RH</p> <p>1104.99051 1398284 / 1738626 SX LH</p> <p>Tappo/Cap : 1104.99056 Tappo/Cap : 1104.99056</p>
	<p>SUPPORTO FARO 2a SERIE - ALLUMINIO LAMP BRACKET 2nd SERIES - ALUMINIUM</p> <p>COS.PEL. ref. SIMILAR ref. 1104.99052 1396937 / 1439349 / 1862946 DX RH</p> <p>1104.99053 1396936 / 1439348 / 1862945 SX LH</p>
	<p>TAPPO CORNICE FARO COVER HEADLIGHT BEZEL</p> <p>COS.PEL. ref. SIMILAR ref. 1104.99056 1425577 / 1650329 DX-SX RH-LH</p>

XF 95 1aSerie XF 95 2aSerie

	<p>SUPPORTO FENDINEBBIA SUPPORT BRACKET FOG LAMP</p> <p>COS.PEL. ref. SIMILAR ref. 1604.10586 1334109 / 1436684 / 1449529 DX RH</p> <p>1604.10587 1334108 / 1436683 / 1449528 SX LH</p>
	<p>PROLUNGA PORTA A.B.S. - BIANCO EXTENSION DOOR A.B.S. - WHITE</p> <p>COS.PEL. ref. SIMILAR ref. 1404.95620 1295620 DX RH</p> <p>1404.95619 1295619 SX LH</p>
<p>AD ESAURIMENTO SCORRE UNTIL SELLS-OUT</p> 	<p>PORTA METALLO DOOR STEEL</p> <p>COS.PEL. ref. SIMILAR ref. 1404.95622 1676219 DX RH</p> <p>1404.95621 1676218 SX LH</p>
 	<p>FANALE LATERALE LAMPADINA ATTACCO AMP - JPT - Relativo connettore 003122 SIDE LAMP BULB CONNECTION AMP - JPT - Related connector 003122</p> <p>COS.PEL. ref. SIMILAR ref. 003001 1303892 / 1329718 DX-SX RH-LH</p> <p>ARANCIO / ORANGE - Relativo portalampada 1601.50013</p>
 	<p>FANALINO LATERALE P21W CORNER LAMP P21W</p> <p>COS.PEL. ref. SIMILAR ref. 1604.10588 1395361 / 1735355 / 1814096 DX-SX RH-LH</p>
 	<p>PROIETTORE H7 H1 P21W W5W - CORRETTORE ASSETTO MANUALE HEADLAMP H7 H1 P21W W5W - MANUAL LOAD LEVEL ADJUSTEMENT</p> <p>COS.PEL. ref. SIMILAR ref. 1604.10580 1641743 / 1699301 / 1743685 DX RH</p> <p>1604.10581 1641742 / 1699300 / 1743684 SX LH</p>
 	<p>PROIETTORE FENDINEBBIA H1 H3 FOG LAMP H1 H3</p> <p>COS.PEL. ref. SIMILAR ref. 1604.10582 1328861 DX RH</p> <p>1604.10583 1328860 SX LH</p>
 	<p>PROIETTORE XENON SENZA CENTRALINA D2S H1 PY21W W5W - PREDISPOSTO PER CORRETTORE ASSETTO HEADLAMP XENON W/O CONTROL UNIT D2S H1 PY21W W5W - SUITABLE FOR LOAD LEVEL ADJUSTEMENT</p> <p>COS.PEL. ref. SIMILAR ref. 1604.10590 1636911 / 1699933 / 1743691 DX RH</p> <p>1604.10589 1699932 / 1743690 SX LH</p>

XF 95 1aSerie XF 95 2aSerie

	<p>MANIGLIA PORTA SENZA CHIAVE DOOR HANDLE WITHOUT KEY</p> <p>COS.PEL. ref. SIMILAR ref. 1704.10560 1305482</p> <p>1704.10561 1305481</p> <p style="text-align: right;">DX RH</p> <p style="text-align: right;">SX LH</p>
	<p>PLASTICA COPRIMANIGLIA P.P. - GRIGIO DOOR HANDLE BEZEL P.P. - GREY</p> <p>COS.PEL. ref. SIMILAR ref. 1704.10562 1305480</p> <p>1704.10563 1305479</p> <p style="text-align: right;">DX RH</p> <p style="text-align: right;">SX LH</p>
	<p>SERRATURA PORTA LATO INTERNO INNER DOOR LOCK</p> <p>COS.PEL. ref. SIMILAR ref. 1704.10564 1296591</p> <p>1704.10565 1296590</p> <p style="text-align: right;">DX RH</p> <p style="text-align: right;">SX LH</p>
	<p>SERRATURA PORTA LATO ESTERNO OUTER DOOR LOCK</p> <p>COS.PEL. ref. SIMILAR ref. 1704.10566 0159150 / 2013730</p> <p>1704.10567 0159149 / 2013729</p> <p style="text-align: right;">DX RH</p> <p style="text-align: right;">SX LH</p>
	<p>ALZACRISTALLI SENZA MOTORINO - 2 FILI WINDOW REGULATOR W/O MOTOR - 2 WIRES</p> <p>COS.PEL. ref. SIMILAR ref. 1904.95648 1918142</p> <p>1904.95649 1918141</p> <p style="text-align: right;">DX RH</p> <p style="text-align: right;">SX LH</p>
	<p>ALZACRISTALLI ELETTRICO - CON MOTORINO - 2 FILI -> 2008 WINDOW REGULATOR ELECTRIC - WITH MOTOR - 2 WIRES -> 2008</p> <p>COS.PEL. ref. SIMILAR ref. 1904.95650 1354703</p> <p>1904.95651 1354702</p> <p style="text-align: right;">DX RH</p> <p style="text-align: right;">SX LH</p>
	<p>VASCHETTA ESPANSIONE EXPANSION TANK</p> <p>COS.PEL. ref. SIMILAR ref. 2104.95080 0393391 / 1295910 / 1607794</p>
	<p>TIRANTE PARAFANGO POSTERIORE GOMMA - NERO MUDGUARD TENSIONER RUBBER - BLACK</p> <p>COS.PEL. ref. SIMILAR ref. 1001.00001 1340450</p>

XF 95 1aSerie XF 95 2aSerie

	<p>MOLLA A GAS Lunghezza [mm] 475 Corsa [mm] 188 Forza scarto [N] 400 GAS SPRING Lenght [mm] 475 Stroke [mm] 188 Waste force [N] 400</p> <p>COS.PEL. ref. SIMILAR ref. 2404.10500 1651601</p>
	<p>MOLLA A GAS Lunghezza [mm] 405 Corsa [mm] 160 Forza scarto [N] 200 GAS SPRING Lenght [mm] 405 Stroke [mm] 160 Waste force [N] 200</p> <p>COS.PEL. ref. SIMILAR ref. 2404.95100 1238280</p>
	<p>DEFLETTORI LATERALI CON CLIPS SIDEWINDOW DEFLECTORS WITH CLIPS</p> <p>COS.PEL. ref. SIMILAR ref. 3004.00001 -</p>
	<p>KIT PER CONNESSIONI ELETTRICHE Connettore HDSCS singolo KIT FOR ELECTRICAL JOINTS Connector HDSCS simple</p> <p>COS.PEL. ref. SIMILAR ref. 003119 -</p>
	<p>KIT PER CONNESSIONI ELETTRICHE Connettore 2 vie JPT KIT FOR ELECTRICAL JOINTS Connector 2 ways JPT</p> <p>COS.PEL. ref. SIMILAR ref. 003122 -</p> <p>Connettore per 003001 - 003003 - 003004</p>
	<p>KIT PER CONNESSIONI ELETTRICHE Connettore SUPERSEAL 2 vie femmina KIT FOR ELECTRICAL JOINTS Connector SUPERSEAL ways female</p> <p>COS.PEL. ref. SIMILAR ref. 003123 -</p> <p>Connettore per la serie 1500.xxxxx</p>
 <p>cm 15,5</p>	<p>FANALE POSTERIORE 7 FUNZIONI REAR-LIGHT 7 FUNCTIONS</p> <p>COS.PEL. ref. SIMILAR ref. 006120 1625986 DX RH 006130 1625985 SX LH Relativo connettore 003120 Con luce targa / With plate light - conn. 003120</p> <p>TRASPARENTE / LENS 011111 1272653 DX-SX RH-LH</p>
 <p>15,2 cm</p>	<p>FANALE POSTERIORE LED - 24V - CONNETTORE POSTERIORE AMP 1.5 REAR-LIGHT LED - 24V - REAR CONNECTOR AMP 1.5</p> <p>COS.PEL. ref. SIMILAR ref. 1500.00000 - DX RH 1500.00001 - SX LH Relativo connettore multipolare 003120 Relativo connettore multipolare 003120</p> <p>TRASPARENTE / LENS</p>

XF 95 1aSerie XF 95 2aSerie

 <p>cm 15,2</p>	<p>FANALE POSTERIORE REAR-LIGHT 7 FUNZIONI 7 FUNCTIONS</p> <p>COS.PEL. ref. 1504.10500 SIMILAR ref. 1625986 Relativo connettore 003120 1504.10501 1625985 Con luce targa / With plate light - conn. 003120</p> <p>TRASPARENTE / LENS 011111 1272653</p> <p>DX RH SX LH DX-SX RH-LH</p>
 <p>cm 16</p>	<p>FANALE POSTERIORE REAR-LIGHT LED - 24V - CONNETTORE LATERALE HDSCS LED - 24V - LATERAL CONNECTOR HDSCS</p> <p>COS.PEL. ref. 1504.10608 SIMILAR ref. - Relativo connettore 003119 1504.10607 - Con luce targa / With plate light - Relativo connettore 003119</p> <p>TRASPARENTE / LENS 1503.45100 - 1503.45101 -</p> <p>DX RH SX LH DX RH SX LH</p>
 <p>cm 16</p>	<p>FANALE POSTERIORE REAR-LIGHT LED - 24V - CONNETTORE POSTERIORE HDSCS LED - 24V - REAR CONNECTOR HDSCS</p> <p>COS.PEL. ref. 1504.10610 SIMILAR ref. - Relativo connettore 003119 1504.10609 - Con luce targa / With plate light - Relativo connettore 003119</p> <p>TRASPARENTE / LENS 1503.45100 - 1503.45101 -</p> <p>DX RH SX LH DX RH SX LH</p>



	<p>GRIGLIA INFERIORE A.B.S. - NERO LOWER GRILLE A.B.S. - BLACK</p> <p>COS.PEL. ref. SIMILAR ref. 104.10501 1635802 / 1954514</p>
	<p>MEZZO PARAFANGO POSTERIORE P.P. - NERO - CON STAFFE REAR MUDGUARD P.P. - BLACK - WITH BRACKETS</p> <p>COS.PEL. ref. SIMILAR ref. 201.28252 1389563</p> <p style="text-align: right;">DX-SX RH-LH</p>
	<p>PARAFANGO POSTERIORE LATERALE SENZA STAFFE P.P. - NERO REAR MUDGUARD WITHOUT BRACKETS P.P. - BLACK</p> <p>COS.PEL. ref. SIMILAR ref. 204.28932 1328934</p> <p style="text-align: center;">(204.28934 versione con le staffe)</p>
	<p>CALOTTA PARAFANGO POSTERIORE CON 4 TIRANTI P.P. - NERO REAR MUDGUARD WITH 4 MUDGUARD TENSIONERS P.P. - BLACK</p> <p>COS.PEL. ref. SIMILAR ref. 204.28933 1328935 / 1340450</p> <p style="text-align: center;">(204.28935 versione senza i tiranti)</p>
	<p>MEZZO PARAFANGO POSTERIORE P.P. - NERO - CON STAFFE REAR MUDGUARD P.P. - BLACK - WITH BRACKETS</p> <p>COS.PEL. ref. SIMILAR ref. 204.28934 1328934</p> <p style="text-align: center;">(204.28932 versione senza staffe)</p>

	<p>CALOTTA PARAFANGO POSTERIORE P.P. - NERO REAR MUDGUARD P.P. - BLACK</p> <p>COS.PEL. ref. 204.28935 SIMILAR ref. 1328935</p> <p style="text-align: right;">DX-SX RH-LH</p> <p>Relativo tirante 1001.00001 - (204.28933 versione con i tiranti)</p>
	<p>CALOTTA PARAFANGO POSTERIORE P.P. - NERO - RIBASSATA REAR MUDGUARD P.P. - BLACK</p> <p>COS.PEL. ref. 204.28936 SIMILAR ref. 1659811</p> <p style="text-align: right;">DX-SX RH-LH</p> <p>Relativo tirante 1001.00001 - (204.28937 versione con i tiranti)</p>
	<p>CALOTTA PARAFANGO POSTERIORE CON 4 TIRANTI P.P. - NERO REAR MUDGUARD WITH 4 MUDGUARD TENSIONERS P.P. - BLACK</p> <p>COS.PEL. ref. 204.28937 SIMILAR ref. 1340450 / 1659811</p> <p style="text-align: right;">DX-SX RH-LH</p> <p>(204.28936 versione senza i tiranti)</p>
	<p>PEDANA A.B.S. - BIANCO FOOTSTEP A.B.S. - WHITE</p> <p>COS.PEL. ref. 304.10510 SIMILAR ref. 1642683 / 1695235</p> <p style="text-align: right;">DX RH</p> <p>304.10511 Griglia/Grille : 1004.00010 1642682 / 1695234 SX LH</p> <p>Griglia/Grille : 1004.00010</p>
	<p>PEDANA SMALTATO A.B.S. - BEIGE FOOTSTEP ENAMELLED A.B.S. - BEIGE</p> <p>COS.PEL. ref. 304.10512 SIMILAR ref. -</p> <p style="text-align: right;">DX RH</p> <p>304.10513 Griglia/Grille : 1004.00010 - SX LH</p> <p>Griglia/Grille : 1004.00010</p>
	<p>PEDANA SMALTATO A.B.S. - BIANCO FOOTSTEP ENAMELLED A.B.S. - WHITE</p> <p>COS.PEL. ref. 304.10514 SIMILAR ref. -</p> <p style="text-align: right;">DX RH</p> <p>304.10515 Griglia/Grille : 1004.00010 - DX RH</p> <p>Griglia/Grille : 1004.00010</p>
	<p>PEDANA PARAFANGO P.P. + F.V. 30% - MUDGUARD FOOTSTEP P.P. + F.V. 30% -</p> <p>COS.PEL. ref. 304.10516 SIMILAR ref. 1796245 / 1836305</p> <p style="text-align: right;">DX RH</p> <p>304.10517 1796244 / 1836304 SX LH</p>
	<p>PARAURTI ANTERIORE SMALTATO METALLO - BIANCO SMALTATO FRONT BUMPER ENAMELLED STEEL - WHITE ENAMELLED</p> <p>COS.PEL. ref. 404.10538 SIMILAR ref. 1634640 / 1826225</p>

	<p>PARAURTI ANTERIORE SMALTATO METALLO - BEIGE SMALTATO FRONT BUMPER ENAMELLED STEEL - BEIGE ENAMELLED</p> <p>COS.PEL. ref. SIMILAR ref. 404.10539 1634640 / 1826225</p>
	<p>PARAURTI ANTERIORE METALLO FRONT BUMPER STEEL</p> <p>COS.PEL. ref. SIMILAR ref. 404.10540 1634640 / 1825008 / 1826225</p>
	<p>PEDANA PARAURTI ALLUMINIO FOOTSTEP FOR BUMPER ALUMINIUM</p> <p>COS.PEL. ref. SIMILAR ref. 404.10541 0948779</p>
	<p>SPECCHIO RETROVISORE ELETTRICO - RISCALDATO REAR-VIEW MIRROR ELECTRIC - HEATED</p> <p>COS.PEL. ref. SIMILAR ref. 504.10530 1689348 / 1812862</p> <p style="text-align: right;">DX-SX RH-LH</p>
	<p>SPECCHIO RETROVISORE GRANDANGOLO - ELETTRICO - RISCALDATO - RAGGIO 300 REAR-VIEW MIRROR WIDE ANGLE - ELECTRIC - HEATED - RADIUS 300</p> <p>COS.PEL. ref. SIMILAR ref. 504.10531 1689347 / 1817860</p> <p style="text-align: right;">DX-SX RH-LH</p>
	<p>VETRO SPECCHIO RISCALDATO MIRROR GLASS HEATED</p> <p>COS.PEL. ref. SIMILAR ref. 504.10532 1685330</p> <p style="text-align: right;">DX-SX RH-LH</p>
	<p>VETRO SPECCHIO GRANDANGOLO - RISCALDATO - RAGGIO 300 MIRROR GLASS WIDE ANGLE - HEATED - RADIUS 300</p> <p>COS.PEL. ref. SIMILAR ref. 504.10533 1685331</p> <p style="text-align: right;">DX-SX RH-LH</p>
	<p>COPERCHIO RETROVISORE COVER MIRROR</p> <p>COS.PEL. ref. SIMILAR ref. 504.10534 1644325 / 1659248</p> <p style="text-align: right;">DX-SX RH-LH</p>

	<p>COPERCHIO RETROVISORE GRANDANGOLO COVER MIRROR WIDE ANGLE</p> <p>COS.PEL. ref. 504.10535 SIMILAR ref. 1644326 / 1659249</p> <p style="text-align: right;">DX-SX RH-LH</p>
	<p>CALOTTA COPRIBRACCIO INFERIORE COVER BRACKET</p> <p>COS.PEL. ref. 504.10536 SIMILAR ref. 1644323 DX RH</p> <p>504.10537 1644324 SX LH</p>
	<p>BRACCIO SPECCHIO MIRROR ARM</p> <p>COS.PEL. ref. 504.10538 SIMILAR ref. 1685325 / 1830562 DX RH</p> <p>504.10539 1685324 / 1812867 SX LH</p>
	<p>SPECCHIO RETROVISORE ELETTRICO - RISCALDATO REAR-VIEW MIRROR ELETTRIC - HEATED</p> <p>COS.PEL. ref. 504.10540 SIMILAR ref. 1644303 DX RH</p> <p>504.10541 1781902 / 1808561 SX LH</p>
	<p>SPECCHIO FRONTALE COMPLETO SPACE CAB COMPLETE MIRROR SPACE CAB</p> <p>COS.PEL. ref. 504.10542 SIMILAR ref. 1684042 / 1816912</p>
	<p>SPECCHIO FRONTALE COMPLETO TETTO BASSO/MEDIO COMPLETE FRONT ROOF MIRROR LOW/MIDDLE CAB</p> <p>COS.PEL. ref. 504.10543 SIMILAR ref. 1684038 / 1816910</p>
	<p>SPECCHIO FRONTALE COMPLETO SUPER SPACE CAB COMPLETE FRONT ROOF MIRROR SUPER SPACE CAB</p> <p>COS.PEL. ref. 504.10544 SIMILAR ref. 1684046 / 1816914</p>
	<p>SPECCHIO GUARDARUOTA RAGGIO 300 ROOF MIRROR RADIUS 300</p> <p>COS.PEL. ref. 504.10545 SIMILAR ref. 1425124 / 1614022 / 1949305</p>

	<p>VISIERA TETTO BASSO TETTO BASSO SUN VISOR LOW CAB LOW CAB</p> <p>COS.PEL. ref. SIMILAR ref. 704.10500 1308687</p> <p>Relativo kit staffe 1004.10500 (oe 1311766)</p>
	<p>VISIERA TETTO MEDIO TETTO MEDIO SUN VISOR MIDLUM CAB MIDLUM CAB</p> <p>COS.PEL. ref. SIMILAR ref. 704.10501 1300557</p> <p>Relativo kit staffe 1004.10501 (oe 1311765)</p>
	<p>VISIERA SUPER SPACE CAB SUN VISOR SUPER SPACE CAB</p> <p>COS.PEL. ref. SIMILAR ref. 704.10502 1651597</p> <p>Relativo kit staffe 1004.10502</p>
<p>AD ESAURIMENTO SCORTE UNTIL SELL-OUT</p> 	<p>DEFLETTORE POSTERIORE PARTE INFERIORE R.T.M. - GRIGIO LOWER REAR FAIRING R.T.M. - GREY</p> <p>COS.PEL. ref. SIMILAR ref. 804.10593 1658401</p> <p style="text-align: right;">SX LH</p>
	<p>CARENATURA SENZA STAFFE (PASSO 3800mm) - STRATIFICAZIONE MANUALE - BIANCO FAIRING WITHOUT BRACKET (WHEEL BASE 3800mm) - G.R.P. - WHITE</p> <p>COS.PEL. ref. SIMILAR ref. 804.10598 1672846 / 1798782</p> <p>Relativo kit staffe 1004.10598</p> <p>804.10599 1684676</p> <p>Relativo kit staffe 1004.10599</p> <p style="text-align: right;">DX RH SX LH</p>
	<p>CONVOGLIATORE ARIA INTERNO 2a serie R.T.M. - GRIGIO INNER CORNER PANEL 2nd series R.T.M. - GREY</p> <p>COS.PEL. ref. SIMILAR ref. 904.00012 1400012</p> <p>904.00011 1400011</p> <p style="text-align: right;">DX RH SX LH</p>
	<p>CONVOGLIATORE ARIA 2a serie A.B.S. - BIANCO AIR CONVEYOR 2nd series A.B.S. - WHITE</p> <p>COS.PEL. ref. SIMILAR ref. 904.00014 1400014</p> <p>904.00013 1400013</p> <p style="text-align: right;">DX RH SX LH</p>
	<p>SUPPORTO PEDANA SALITA ALLUMINIO FOOTSTEP BRACKET ALUMINIUM</p> <p>COS.PEL. ref. SIMILAR ref. 1004.10550 1641631</p> <p>1004.10551 1641630</p> <p style="text-align: right;">DX RH SX LH</p>

XF 105

	<p>TRAVERSA PARAURTI ANTERIORE METALLO - NERO BUMPER BRACKET STEEL - BLACK</p> <p>COS.PEL. ref. SIMILAR ref. 1004.10552 1662370 / 1674548</p>
	<p>SUPPORTO PARAURTI METALLO BUMPER BRACKET STEEL</p> <p>COS.PEL. ref. SIMILAR ref. 1004.10554 1667521 / 1693665 DX RH</p> <p>1004.10553 1667520 / 1693664 SX LH</p>
	<p>COPRI BATTERIE BATTERY COVER</p> <p>COS.PEL. ref. SIMILAR ref. 1004.10555 1603386 / 1732653 / 1745335</p>
	<p>COLLARE DI FISSAGGIO PARAFANGO METALLO BRACKET MUDGUARD METAL</p> <p>COS.PEL. ref. SIMILAR ref. 1006.33602 1649588</p>
	<p>CORNICE FENDINEBBIA CON SMALTO P.C.+P.B.T. - BIANCO BRILLANTE BUMPER FOG LAMP HEADLIGHT BEZEL WITH ENAMEL P.C.+P.B.T. - WHITE</p> <p>COS.PEL. ref. SIMILAR ref. 1104.10516 1649364 / 1683722 / 1973360 DX RH</p> <p>1104.10517 1649363 / 1683722 / 1973359 SX LH</p>
	<p>CORNICE FENDINEBBIA CON SMALTO P.C.+P.B.T. - BEIGE BRILLANTE BUMPER FOG LAMP HEADLIGHT BEZEL WITH ENAMEL P.C.+P.B.T. - BEIGE</p> <p>COS.PEL. ref. SIMILAR ref. 1104.10518 1649364 / 1683722 / 1973360 DX RH</p> <p>1104.10519 1649363 / 1683722 / 1973359 SX LH</p>
	<p>CORNICE FENDINEBBIA SU PARAURTI P.C. + P.B.T. BUMPER FOG LAMP HEADLAMP FRAME P.C. + P.B.T.</p> <p>COS.PEL. ref. SIMILAR ref. 1104.10520 1649364 / 1683722 / 1973360 DX RH</p> <p>1104.10521 1649363 / 1683721 / 1973359 SX LH</p>
	<p>CORNICE FENDINEBBIA SU PARAURTI SENZA FORI P.C.+P.B.T. BUMPER FOG LAMP HEADLIGHT BEZEL W/O HOLES P.C.+P.B.T.</p> <p>COS.PEL. ref. SIMILAR ref. 1104.10522 1684872 / 1695110 DX RH</p> <p>1104.10523 1684871 / 1695109 SX LH</p>

	<p>CORNICE FARO A.B.S. - BIANCO - 2a SERIE HEADLAMP FRAME A.B.S. - WHITE - 2nd SERIES COS.PEL. ref. SIMILAR ref. 1104.99050 1398285 / 1738627 DX RH</p> <p>Tappo/Cap : 1104.99056 1104.99051 1398284 / 1738626 SX LH</p> <p>Tappo/Cap : 1104.99056</p>
	<p>SUPPORTO FARO 2a SERIE - ALLUMINIO LAMP BRACKET 2nd SERIES - ALUMINIUM COS.PEL. ref. SIMILAR ref. 1104.99052 1396937 / 1439349 / 1862946 DX RH</p> <p>1104.99053 1396936 / 1439348 / 1862945 SX LH</p>
	<p>CORNICE FARO A.B.S. - BEIGE BRILLANTE - 2a SERIE HEADLAMP FRAME A.B.S. - BEIGE WITH ENAMEL - 2nd SERIES COS.PEL. ref. SIMILAR ref. 1104.99054 1398285 / 1738627 DX RH</p> <p>Tappo/Cap : 1104.99056 1104.99055 1398284 / 1738626 SX LH</p> <p>Tappo/Cap : 1104.99056</p>
	<p>TAPPO CORNICE FARO COVER HEADLIGHT BEZEL COS.PEL. ref. SIMILAR ref. 1104.99056 1425577 / 1650329 DX-SX RH-LH</p>
	<p>CORNICE FARO SMALTATO A.B.S. - BIANCO SMALTATO - 2a SERIE HEADLAMP FRAME ENAMELLED A.B.S. - WHITE ENAMELLED - 2nd SERIES COS.PEL. ref. SIMILAR ref. 1104.99058 1398285 / 1738627 DX RH</p> <p>Tappo/Cap : 1104.99056 1104.99057 1398284 / 1738626 SX LH</p> <p>Tappo/Cap : 1104.99056</p>
	<p>PROLUNGA PORTA A.B.S. - BIANCO EXTENSION DOOR A.B.S. - WHITE COS.PEL. ref. SIMILAR ref. 1404.95620 1295620 DX RH</p> <p>1404.95619 1295619 SX LH</p>
<p>AD ESAURIMENTO SCORRE UNTIL SILLS-OUT</p> 	<p>PORTA METALLO DOOR STEEL COS.PEL. ref. SIMILAR ref. 1404.95622 1676219 DX RH</p> <p>1404.95621 1676218 SX LH</p>
 	<p>FANALE LATERALE LAMPADINA ATTACCO AMP - JPT - Relativo connettore 003122 SIDE LAMP BULB CONNECTION AMP - JPT - Related connector 003122 COS.PEL. ref. SIMILAR ref. 003001 1303892 / 1329718 DX-SX RH-LH</p> <p>ARANCIO / ORANGE - Relativo portalamпада 1601.50013</p>

	<p> FANALINO LATERALE P21W CORNER LAMP P21W</p> <p>COS.PEL. ref. SIMILAR ref. 1604.10588 1395361 / 1735355 / 1814096 DX-SX RH-LH</p>
	<p> PROIETTORE H7 H1 P21W W5W - CORRETTORE ASSETTO MANUALE HEADLAMP H7 H1 P21W W5W - MANUAL LOAD LEVEL ADJUSTEMENT</p> <p>COS.PEL. ref. SIMILAR ref. 1604.10580 1641743 / 1699301 / 1743685 DX RH</p> <p>1604.10581 1641742 / 1699300 / 1743684 SX LH</p>
	<p> PROIETTORE FENDINEBBIA H3 FOG LAMP H3</p> <p>COS.PEL. ref. SIMILAR ref. 1604.10584 1660961 / 1725271 DX RH</p> <p>1604.10585 1660960 / 1725270 SX LH</p>
	<p> PROIETTORE XENON SENZA CENTRALINA D2S H1 PY21W W5W - PREDISPOSTO PER CORRETTORE ASSETTO HEADLAMP XENON W/O CONTROL UNIT D2S H1 PY21W W5W - SUITABLE FOR LOAD LEVEL ADJUSTEMENT</p> <p>COS.PEL. ref. SIMILAR ref. 1604.10590 1636911 / 1699933 / 1743691 DX RH</p> <p>1604.10589 1699932 / 1743690 SX LH</p>
	<p>MANIGLIA PORTA SENZA CHIAVE DOOR HANDLE WITHOUT KEY</p> <p>COS.PEL. ref. SIMILAR ref. 1704.10560 1305482 DX RH</p> <p>1704.10561 1305481 SX LH</p>
	<p>SERRATURA PORTA LATO INTERNO INNER DOOR LOCK</p> <p>COS.PEL. ref. SIMILAR ref. 1704.10564 1296591 DX RH</p> <p>1704.10565 1296590 SX LH</p>
	<p>SERRATURA PORTA LATO ESTERNO OUTER DOOR LOCK</p> <p>COS.PEL. ref. SIMILAR ref. 1704.10566 0159150 / 2013730 DX RH</p> <p>1704.10567 0159149 / 2013729 SX LH</p>
	<p>ALZACRISTALLI SENZA MOTORINO - 2 FILI WINDOW REGULATOR W/O MOTOR - 2 WIRES</p> <p>COS.PEL. ref. SIMILAR ref. 1904.95648 1918142 DX RH</p> <p>1904.95649 1918141 SX LH</p>

	<p>ALZACRISTALLI ELETTRICO ELETTRICO - CON MOTORINO - 2 FILI - -> 2008 WINDOW REGULATOR ELECTRIC - WITH MOTOR - 2 WIRES - -> 2008 COS.PEL. ref. SIMILAR ref. 1904.95650 1354703</p> <p>1904.95651 1354702</p> <p style="text-align: right;">DX RH</p> <p style="text-align: right;">SX LH</p>
	<p>ALZACRISTALLI ELETTRICO ELETTRICO - SENZA MOTORINO WINDOW REGULATOR ELECTRIC - W/O MOTOR COS.PEL. ref. SIMILAR ref. 1904.95652 1918146 / 2130643</p> <p>1904.95653 1918145 / 2130642</p> <p style="text-align: right;">DX RH</p> <p style="text-align: right;">SX LH</p>
	<p>ALZACRISTALLI ELETTRICO ELETTRICO - CON MOTORINO - 24 V - MOTORE COMFORT - 6 PIN WINDOW REGULATOR ELECTRIC - WITH MOTOR - 24 V - 6 PIN COS.PEL. ref. SIMILAR ref. 1904.95654 1779722 / 2148574</p> <p>1904.95655 1779721 / 2148573</p> <p style="text-align: right;">DX RH</p> <p style="text-align: right;">SX LH</p>
	<p>TIRANTE PARAFANGO POSTERIORE GOMMA - NERO MUDGUARD TENSIONER RUBBER - BLACK COS.PEL. ref. SIMILAR ref. 1001.00001 1340450</p>
	<p>MOLLA A GAS Lunghezza [mm] 475 Corsa [mm] 188 Forza scarto [N] 400 GAS SPRING Lenght [mm] 475 Stroke [mm] 188 Waste force [N] 400 COS.PEL. ref. SIMILAR ref. 2404.10500 1651601</p>
	<p>KIT PER CONNESSIONI ELETTRICHE Connettore HDSCS singolo KIT FOR ELECTRICAL JOINTS Connector HDSCS simple COS.PEL. ref. SIMILAR ref. 003119 -</p>
	<p>KIT PER CONNESSIONI ELETTRICHE Connettore 2 vie JPT KIT FOR ELECTRICAL JOINTS Connector 2 ways JPT COS.PEL. ref. SIMILAR ref. 003122 -</p> <p style="text-align: right;">Connettore per 003001 - 003003 - 003004</p>
	<p>FANALE POSTERIORE LED REAR-LIGHT LED COS.PEL. ref. SIMILAR ref. 006132 -</p> <p>006133 - Relativo connettore 003120</p> <p>011112 - Con luce targa / With plate light - conn. 003120</p> <p>TRASPARENTE / LENS</p> <p style="text-align: right;">DX RH</p> <p style="text-align: right;">SX LH</p> <p style="text-align: right;">DX-SX RH-LH</p>

XF 105

	<p>FANALE POSTERIORE REAR-LIGHT LED - 24V - CONNETTORE LATERALE HDSCS LED - 24V - LATERAL CONNECTOR HDSCS</p> <p>COS.PEL. ref. SIMILAR ref. 1504.10608 - DX RH - Relativo connettore 003119 1504.10607 - SX LH - Con luce targa / With plate light - Relativo connettore 003119 TRASPARENTE / LENS 1503.45100 - DX RH 1503.45101 - SX LH</p>
	<p>FANALE POSTERIORE REAR-LIGHT LED - 24V - CONNETTORE POSTERIORE HDSCS LED - 24V - REAR CONNECTOR HDSCS</p> <p>COS.PEL. ref. SIMILAR ref. 1504.10610 - DX RH - Relativo connettore 003119 1504.10609 - SX LH - Con luce targa / With plate light - Relativo connettore 003119 TRASPARENTE / LENS 1503.45100 - DX RH 1503.45101 - SX LH</p>



	<p>GRIGLIA COMPLETA Completa di staffe e listelli cromati GRILLE With chrome brackets and strips</p> <p>COS.PEL. ref. SIMILAR ref. 104.10600 1886591 / 2046502 / 2048272</p>
	<p>SUPPORTO GRIGLIA ALLUMINIO GRILLE BRACKET ALUMINIUM</p> <p>COS.PEL. ref. SIMILAR ref. 104.10602 1857654 DX RH</p> <p>104.10601 1857653 SX LH</p>
	<p>PANNELLO FRONTALE FRONT PANEL</p> <p>COS.PEL. ref. SIMILAR ref. 104.10603 2104217</p>
	<p>GRIGLIA FRONTALE FRONT GRILLE</p> <p>COS.PEL. ref. SIMILAR ref. 104.10604 1887709 / 1936285</p>
	<p>CALOTTA PARAFANGO POSTERIORE CON 4 TIRANTI P.P. - NERO REAR MUDGUARD WITH 4 MUDGUARD TENSIONERS P.P. - BLACK</p> <p>COS.PEL. ref. SIMILAR ref. 204.10529 1875551 / 1875552 / 1927847 DX-SX RH-LH</p> <p>(204.10530 versione senza i tiranti)</p>

	<p>CALOTTA PARAFANGO POSTERIORE P.P. - NERO REAR MUDGUARD P.P. - BLACK</p> <p>COS.PEL. ref. 204.10530 SIMILAR ref. 1875551 / 1875552 DX-SX RH-LH</p> <p>Relativo tirante 1004.10530 - (204.10529 versione con i tiranti)</p>
	<p>MEZZO PARAFANGO POST. PARTE POST. CON STAFFE P.P. - NERO - SENZA ANTISPRAY REAR MUDGUARD REAR PART WITH BRACKETS P.P. - BLACK - W/O ANTISPRAY</p> <p>COS.PEL. ref. 204.10532 SIMILAR ref. 1875554 / 2120352 / 1875564 / 2120360 / 1892198 / 2120362 / 1936302 Antispray DX RH</p> <p>204.10531 1875553 / 2120351 / 1875563 / 2120359 / 1892197 / 2120361 / 1936302 Antispray SX LH</p> <p>Staffe/brackets : 1004.10531</p>
	<p>MEZZO PARAFANGO POST. PARTE ANT. CON STAFFE P.P. - NERO - CON STAFFE (cod. 1004.10533) REAR MUDGUARD FRONT PART WITH BRACKETS P.P. - BLACK - WITH BRACKETS (ref. 1004.10533)</p> <p>COS.PEL. ref. 204.10534 SIMILAR ref. 1875550 DX RH</p> <p>204.10533 1875549 SX LH</p>
	<p>CALOTTA PROTETTIVA P.P. - NERO PROTECTIVE COVER P.P. - BLACK</p> <p>COS.PEL. ref. 204.10535 SIMILAR ref. 1875567 DX-SX RH-LH</p>
	<p>MEZZO PARAFANGO POST. PARTE ANT. CON STAFFE P.P. - NERO - CON STAFFE REAR MUDGUARD FRONT PART WITH BRACKETS P.P. - BLACK - WITH BRACKET</p> <p>COS.PEL. ref. 204.10536 SIMILAR ref. 1892246 DX RH</p> <p>204.10537 Relative staffe 1004.10531 1892245 SX LH</p> <p>Relative staffe 1004.10531</p>
	<p>PARASPRUZZI REAR MUDGUARD FLAP</p> <p>COS.PEL. ref. 204.10540 SIMILAR ref. 1936302 DX-SX RH-LH</p>
	<p>MEZZO PARAFANGO POST. (PARTE ANTERIORE) P.P. - NERO - CON STAFFE REAR MUDGUARD (FRONT PART) P.P. - BLACK - WITH BRACKET</p> <p>COS.PEL. ref. 204.10541 SIMILAR ref. 1892248 DX-SX RH-LH</p> <p>Relative staffe : 1004.10531</p>
	<p>PEDANA S.M.C. FOOTSTEP S.M.C.</p> <p>COS.PEL. ref. 204.10620 SIMILAR ref. 1835024 / 1861673 DX RH</p> <p>204.10621 Griglia/grille : 1004.10620 inf. - 1004.10622 sup. 1835023 / 1861672 SX LH</p> <p>Griglia/grille : 1004.10621 inf. - 1004.10622 sup.</p>

	<p>ESTENSIONE PARAFANGO S.M.C. EXTENSION MUDGUARD S.M.C. COS.PEL. ref. SIMILAR ref. 204.10622 1835028 / 1843493</p> <p>204.10623 1835027 / 1843492</p> <p style="text-align: right;">DX RH</p> <p style="text-align: right;">SX LH</p>
	<p>COPERCHIO ESTENSIONE PARAFANGO S.M.C. EXTENSION MUDGUARD COVER S.M.C. COS.PEL. ref. SIMILAR ref. 204.10624 1835032</p> <p>204.10625 1835031</p> <p style="text-align: right;">DX RH</p> <p style="text-align: right;">SX LH</p>
	<p>TAPPO PEDANA PARAFANGO MUDGUARD COVER COS.PEL. ref. SIMILAR ref. 204.10626 1835065</p> <p>204.10627 1835066</p> <p style="text-align: right;">DX RH</p> <p style="text-align: right;">SX LH</p>
	<p>PEDANA A.B.S. - BIANCO FOOTSTEP A.B.S. - WHITE COS.PEL. ref. SIMILAR ref. 304.10610 1798462 / 1948244</p> <p>304.10611</p> <p style="text-align: right;">DX RH</p> <p style="text-align: right;">SX LH</p> <p style="text-align: right;">Griglia/Grille : 1004.10650 1798461 / 1948243 Griglia/Grille : 1004.10651</p>
	<p>TAPPO PEDANA A.B.S. - BIANCO FOOTSTEP COVER A.B.S. - WHITE COS.PEL. ref. SIMILAR ref. 304.10612 1828856</p> <p>304.10613 1828855</p> <p style="text-align: right;">DX RH</p> <p style="text-align: right;">SX LH</p>
	<p>PEDANA SMALTATO A.B.S. - BEIGE SMALTATO FOOTSTEP ENAMELLED A.B.S. - BEIGE ENAMELLED COS.PEL. ref. SIMILAR ref. 304.10614 1798462 / 1948244</p> <p>304.10615</p> <p style="text-align: right;">DX RH</p> <p style="text-align: right;">SX LH</p> <p style="text-align: right;">Griglia/Grille : 1004.10650 1798461 / 1948243 Griglia/Grille : 1004.10650</p>
	<p>TAPPO PEDANA SMALTATO A.B.S. - BEIGE SMALTATO FOOTSTEP COVER ENAMELLED A.B.S. - BEIGE ENAMELLED COS.PEL. ref. SIMILAR ref. 304.10616 1828856</p> <p>304.10617 1828855</p> <p style="text-align: right;">DX RH</p> <p style="text-align: right;">SX LH</p>
	<p>PARAURTI METALLO - NERO FRONT BUMPER STEEL - BLACK COS.PEL. ref. SIMILAR ref. 404.10690 1869588 / 1953385</p>

	<p>SOTTOPARAURTI CENTRALE P.P. - NERO BUMPER P.P. - BLACK</p> <p>COS.PEL. ref. SIMILAR ref. 404.10691 1826510</p>
	<p>SPORETTO CENTRALE PARAURTI P.P. BUMPER CENTRAL COVER P.P.</p> <p>COS.PEL. ref. SIMILAR ref. 404.10692 1825434 / 1861983</p>
	<p>PARAURTI ANTERIORE SMALTATO METALLO - BEIGE SMALTATO FRONT BUMPER ENAMELLED STEEL - BEIGE ENAMELLED</p> <p>COS.PEL. ref. SIMILAR ref. 404.10693 1869588 / 1953385</p>
	<p>SPECCHIO RETROVISORE ELETTRICO - RISCALDATO REAR-VIEW MIRROR ELECTRIC - HEATED</p> <p>COS.PEL. ref. SIMILAR ref. 504.10530 1689348 / 1812862</p> <p style="text-align: right;">DX-SX RH-LH</p>
	<p>VETRO SPECCHIO RISCALDATO MIRROR GLASS HEATED</p> <p>COS.PEL. ref. SIMILAR ref. 504.10532 1685330</p> <p style="text-align: right;">DX-SX RH-LH</p>
	<p>SPECCHIO RETROVISORE ELETTRICO - RISCALDATO - GRANDANGOLO REAR-VIEW MIRROR ELECTRIC - HEATED - WIDE ANGLE</p> <p>COS.PEL. ref. SIMILAR ref. 504.10630 1940341</p>
	<p>VETRO SPECCHIO GRANDANGOLO - RISCALDATO MIRROR GLASS WIDE ANGLE - HEATED</p> <p>COS.PEL. ref. SIMILAR ref. 504.10631 1940342</p> <p style="text-align: right;">DX-SX RH-LH</p>
	<p>BRACCIO SPECCHIO MIRROR ARM</p> <p>COS.PEL. ref. SIMILAR ref. 504.10639 1940335</p> <p style="text-align: right;">DX RH</p> <p>504.10638 1940334</p> <p style="text-align: right;">SX LH</p>

	<p>CONVOGLIATORE ARIA S.M.C. AIR CONVEYOR S.M.C. COS.PEL. ref. SIMILAR ref. 904.10680 1835710 / 1835764 / 2114705 DX RH</p> <p>904.10681 1835709 / 1835763 / 2114704 SX LH</p>
	<p>CONVOGLIATORE ARIA AIR CONVEYOR COS.PEL. ref. SIMILAR ref. 904.10682 1835710 / 2114705 DX RH</p> <p>904.10683 1835710 / 2114705 SX LH</p>
	<p>SUPPORTO PARAFANGO POST. PARTE POST. KIT DUE PEZZI - Per 204.10531/2 REAR MUDGUARD BRACKET REAR PART TWO PIECES KIT - For 204.10531/2 COS.PEL. ref. SIMILAR ref. 1004.10531 -</p>
	<p>SUPPORTO PARAFANGO POST. PARTE ANT. KIT DUE PEZZI - Per 204.10533/4 REAR MUDGUARD BRACKET FRONT PART TWO PIECES KIT - For 204.10533/4 COS.PEL. ref. SIMILAR ref. 1004.10533 -</p>
	<p>SUPPORTO PARAFANGO POSTERIORE TUBO CON CURVA CM 61,5 MUDGUARD BRACKET BENT BRACKET CM 61,5 COS.PEL. ref. SIMILAR ref. 1004.10556 1371225 / 1371226</p>
	<p>SUPPORTO PARAFANGO POSTERIORE TUBO DIRITTO CM 61,5 MUDGUARD BRACKET STRAIGHT BRACKET CM 61,5 COS.PEL. ref. SIMILAR ref. 1004.10557 1371224</p>
	<p>SUPPORTO PARAFANGO POSTERIORE TUBO DIRITTO CM 73 MUDGUARD BRACKET STRAIGHT BRACKET CM 73 COS.PEL. ref. SIMILAR ref. 1004.10558 1893586</p>
	<p>SUPPORTO PARAFANGO POSTERIORE TUBO CON CURVA CM 73 MUDGUARD BRACKET BENT BRACKET CM 73 COS.PEL. ref. SIMILAR ref. 1004.10559 1893585</p>

XF 106

	<p>GRIGLIA PEDANA INFERIORE LOWER FOOTSTEP GRILLE</p> <p>COS.PEL. ref. SIMILAR ref. 1004.10620 1945946 DX RH</p> <p>1004.10621 Pedana/footstep : 204.10620 1945945 SX LH</p> <p>Pedana/footstep : 204.10621</p>
	<p>GRIGLIA PEDANA SUPERIORE UPPER FOOTSTEP GRILLE</p> <p>COS.PEL. ref. SIMILAR ref. 1004.10622 1945944 DX-SX RH-LH</p> <p>Pedana/footstep : 204.10620 - 204.10621</p>
	<p>PIASTRA PEDANA ALLUMINIO STEP PLATE ALUMINIUM</p> <p>COS.PEL. ref. SIMILAR ref. 1004.10650 1798464 / 1945872 DX RH</p> <p>1004.10651 1798463 / 1945871 SX LH</p>
	<p>SUPPORTO PEDANA ALLUMINIO STEP PLATE ALUMINIUM</p> <p>COS.PEL. ref. SIMILAR ref. 1004.10652 1798460 / 1948152 DX RH</p> <p>1004.10653 1798459 / 1948151 SX LH</p>
	<p>SUPPORTO PARAURTI BUMPER BRACKET</p> <p>COS.PEL. ref. SIMILAR ref. 1004.10654 1895878 / 1922986 DX RH</p> <p>1004.10655 1895877 / 1922985 SX LH</p>
	<p>SUPPORTO FARO PLASTICA LAMP BRACKET PLASTIC</p> <p>COS.PEL. ref. SIMILAR ref. 1104.10612 2107373 DX RH</p> <p>1104.10613 2107372 SX LH</p>
	<p>SUPPORTO FARO ALLUMINIO LAMP BRACKET ALUMINIUM</p> <p>COS.PEL. ref. SIMILAR ref. 1104.10614 1798449 DX RH</p> <p>1104.10615 1798448 SX LH</p>
	<p>CORNICE FARO A.B.S. - ARGENTO BUMPER LAMP HEADLIGHT BEZEL A.B.S. - SILVER</p> <p>COS.PEL. ref. SIMILAR ref. 1104.10616 1798458 / 1922031 / 2011377 DX RH</p> <p>1104.10617 1798457 / 1922030 / 2011376 SX LH</p>

	CORNICE FARO A.B.S. - BIANCO BUMPER LAMP HEADLIGHT BEZEL A.B.S. - WHITE COS.PEL. ref. SIMILAR ref. 1104.10618 1861950 1104.10619 1861949	DX RH SX LH
	CORNICE FENDI CON FORI A.B.S. - BIANCO FOG LAMP FRAME WITH HOLES A.B.S. - WHITE COS.PEL. ref. SIMILAR ref. 1104.10620 1798472 / 1880379 1104.10621 1798471 / 1880378	DX RH SX LH
	CORNICE FENDI SENZA FORI A.B.S. - BIANCO BUMPER LAMP HEADLIGHT BEZEL A.B.S. - WHITE COS.PEL. ref. SIMILAR ref. 1104.10622 1880398 1104.10623 1880397	DX RH SX LH
	CORNICE FARO A.B.S. - BIANCO HEADLAMP FRAME A.B.S. - WHITE COS.PEL. ref. SIMILAR ref. 1104.10624 2033876 1104.10625 2033875	DX RH SX LH
	CORNICE FENDI CON FORO SMALTATO A.B.S. - BEIGE SMALTATO FOG LAMP FRAME WITH HOLE ENAMELLED A.B.S. - BEIGE ENAMELLED COS.PEL. ref. SIMILAR ref. 1104.10626 1798472 / 1880379 1104.10627 1798471 / 1880378	DX RH SX LH
	CORNICE FARO SMALTATO A.B.S. - BEIGE SMALTATO HEADLAMP FRAME ENAMELLED A.B.S. - BEIGE ENAMELLED COS.PEL. ref. SIMILAR ref. 1104.10628 1861950 1104.10629 1861949	DX RH SX LH
	CORNICE FARO SMALTATO A.B.S. - BEIGE SMALTATO HEADLAMP FRAME ENAMELLED A.B.S. - BEIGE ENAMELLED COS.PEL. ref. SIMILAR ref. 1104.10630 2033876 1104.10631 2033875	DX RH SX LH
	SOTTOPORTA DOOR EXTENSION COS.PEL. ref. SIMILAR ref. 1404.10670 1835171 / 2041670 / 2046359 1404.10671 1835170 / 2041669 / 2046358	DX RH SX LH

XF 106

	<p>SOTTOPORTA SMALTATO BEIGE DOOR EXTENSION ENAMELLED BEIGE</p> <p>COS.PEL. ref. SIMILAR ref. 1404.10672 1835171 / 2041670 / 2046359 DX RH</p> <p>1404.10673 1835170 / 2041669 / 2046358 SX LH</p>
 	<p>LUCE DI DIREZIONE P21YW SIDE LAMP P21YW</p> <p>COS.PEL. ref. SIMILAR ref. 1604.10604 1846492 DX RH</p> <p>1604.10605 Portalamпада / Bulb holder : 1606.92810 1846491 SX LH</p> <p>Portalamпада / Bulb holder : 1606.92810</p>
 	<p>PROIETTORE SENZA CENTRALINA H7 H1 PY21W - LED - MANUALE / ELETTRICO HEADLAMP W/O CONTROL UNIT H7 H1 PY21W - LED - MANUAL / ELECTRIC</p> <p>COS.PEL. ref. SIMILAR ref. 1604.10600 1835875 DX RH</p> <p>1604.10601 1835874 SX LH</p>
 	<p>FENDINEBBIA H11 FOG LAMP H11</p> <p>COS.PEL. ref. SIMILAR ref. 1604.10602 1835887 / 2032704 DX RH</p> <p>1604.10603 1835886 / 2032703 SX LH</p>
 	<p>PROIETTORE SENZA CENTRALINA FULL LED - H1 PY21W 2 LED - MANUALE / ELETTRICO HEADLAMP W/O CONTROL UNIT FULL LED - H1 PY21W 2 LED - MANUAL / ELECTRIC</p> <p>COS.PEL. ref. SIMILAR ref. 1604.10606 1857527 DX RH</p> <p>1604.10607 1857526 SX LH</p>
	<p>SERRATURA PORTA LATO INTERNO INNER DOOR LOCK</p> <p>COS.PEL. ref. SIMILAR ref. 1704.10564 1296591 DX RH</p> <p>1704.10565 1296590 SX LH</p>
	<p>SERRATURA PORTA LATO ESTERNO OUTER DOOR LOCK</p> <p>COS.PEL. ref. SIMILAR ref. 1704.10566 0159150 / 2013730 DX RH</p> <p>1704.10567 0159149 / 2013729 SX LH</p>
	<p>MANIGLIA PORTA SENZA CHIAVE DOOR HANDLE WITHOUT KEY</p> <p>COS.PEL. ref. SIMILAR ref. 1704.10600 1872761 DX RH</p> <p>1704.10601 1872760 SX LH</p>

XF 106

	<p>FANALE POSTERIORE REAR-LIGHT LED - 24V - CONNETTORE LATERALE HDSCS LED - 24V - LATERAL CONNECTOR HDSCS</p> <p>COS.PEL. ref. SIMILAR ref. 1504.10608 - DX RH - Relativo connettore 003119 1504.10607 - SX LH - Con luce targa / With plate light - Relativo connettore 003119 TRASPARENTE / LENS 1503.45100 - DX RH 1503.45101 - SX LH</p>
	<p>FANALE POSTERIORE REAR-LIGHT LED - 24V - CONNETTORE POSTERIORE HDSCS LED - 24V - REAR CONNECTOR HDSCS</p> <p>COS.PEL. ref. SIMILAR ref. 1504.10610 - DX RH - Relativo connettore 003119 1504.10609 - SX LH - Con luce targa / With plate light - Relativo connettore 003119 TRASPARENTE / LENS 1503.45100 - DX RH 1503.45101 - SX LH</p>



Parti di ricambio adattabili a:
Spare parts suitable to:



	<p>GRIGLIA FRONTALE A.B.S. FRONTAL GRILLE A.B.S.</p> <p>COS.PEL. ref. SIMILAR ref. 105.91200 9018800385</p>
	<p>FRONTALE METALLO FRONT PANEL STEEL</p> <p>COS.PEL. ref. SIMILAR ref. 105.91201 9018800103</p>
	<p>COFANO METALLO HOOD STEEL</p> <p>COS.PEL. ref. SIMILAR ref. 105.91202 9017500202</p>
	<p>PARAFANGO METALLO MUDGUARD STEEL</p> <p>COS.PEL. ref. SIMILAR ref. 205.91100 9016307007 DX RH</p> <p>205.91101 9016306907 SX LH</p>
	<p>PARAURTI ANTERIORE P.P. - GRIGIO FRONT BUMPER P.P. - GREY</p> <p>COS.PEL. ref. SIMILAR ref. 405.91670 9018800670 / 9018800870</p>

	<p>RINFORZO PARAURTI ANTERIORE METALLO FRONT BUMPER REINFORCEMENT STEEL</p> <p>COS.PEL. ref. SIMILAR ref. 405.91671 9013100722</p>
 	<p>PROIETTORE HEADLAMP</p> <p>COS.PEL. ref. SIMILAR ref. 1605.91600 A9018201161 DX RH</p> <p>1605.91601 A9018201061 SX LH</p>
	<p>MANIGLIA PORTA SENZA CHIAVE DOOR HANDLE WITHOUT KEY</p> <p>COS.PEL. ref. SIMILAR ref. 1705.97310 0007601359 DX-SX RH-LH</p>
<p>AD ESAURIMENTO SCORTE UNTIL STILL-GIFT</p> 	<p>GUARNIZIONE PARABREZZA WINDSCREEN GASKET</p> <p>COS.PEL. ref. SIMILAR ref. 1805.91094 9016710020 / 9016710220</p>
	<p>ALZACRISTALLI ELETTRICO - CON MOTORINO - 2 FILI WINDOW REGULATOR ELECTRIC - WITH MOTOR - 2 WIRES</p> <p>COS.PEL. ref. SIMILAR ref. 1905.91500 9017201246 DX RH</p> <p>1905.91501 9017201146 SX LH</p>
 <p>155 440</p>	<p>PROTEZIONE FARO Per Cos.Me Atego/Sprinter GRID For Cos.Me Atego/Sprinter</p> <p>COS.PEL. ref. SIMILAR ref. 2000.00013 -</p>
 <p>cm 15,3</p>	<p>FANALE POSTERIORE 7 FUNZIONI REAR-LIGHT 7 FUNCTIONS</p> <p>COS.PEL. ref. SIMILAR ref. 005740 A0025445403 DX RH</p> <p>005750 A0025445503 SX LH Con luce targa / With plate light</p> <p>TRASPARENTE / LENS 011241 A0025444790 DX-SX RH-LH</p>
 	<p>FANALE POSTERIORE SENZA PORTALAMPADA REAR-LIGHT WITHOUT LAMPHOLDER</p> <p>COS.PEL. ref. SIMILAR ref. 009120 A0008261656 DX RH Portalamпада / Lampholder : 009122</p> <p>009121 A0008261556 SX LH Portalamпада / Lampholder : 009122</p> <p>TRASPARENTE / LENS</p>

Sprinter 2000



**PORTALAMPADA
LAMP BULB HOLDER**

COS.PEL. ref.
009122

SIMILAR ref.

-

Per lampada / For lamp : 009120 / 009121



	<p>COFANO METALLO HOOD STEEL</p> <p>COS.PEL. ref. SIMILAR ref. 105.92100 A9067500002</p>
	<p>GRIGLIA FRONTALE A.B.S. FRONT GRILLE A.B.S.</p> <p>COS.PEL. ref. SIMILAR ref. 105.92101 A9068800385</p>
	<p>PANNELLO SUPPORTO RADIATORE NERO RADIATOR SUPPORT PANEL BLACK</p> <p>COS.PEL. ref. SIMILAR ref. 105.92102 9068800003</p>
	<p>PANNELLO FRONTALE METALLO - NERO FRONT NOSE PANEL STEEL - BLACK</p> <p>COS.PEL. ref. SIMILAR ref. 105.92103 9066200024</p>
	<p>PARAFANGO METALLO MUDGUARD STEEL</p> <p>COS.PEL. ref. SIMILAR ref. 205.92200 A9066377819 DX RH</p> <p>205.92201 A9066377719 SX LH</p>

Sprinter 2006

	<p>PARAURTI ANTERIORE P.P. - GRIGIO - SENZA FORI FENDI FRONT BUMPER P.P. - GREY - W/O HOLES</p> <p>COS.PEL. ref. SIMILAR ref. 405.92190 A9068800170</p>
	<p>PARAURTI ANTERIORE P.P. - GRIGIO - CON FORI FENDI FRONT BUMPER P.P. - GREY - WITH HOLES</p> <p>COS.PEL. ref. SIMILAR ref. 405.92191 A9068800570-9B51</p>
	<p>RINFORZO PARAURTI ANTERIORE FRONT BUMPER REINFORCEMENT</p> <p>COS.PEL. ref. SIMILAR ref. 405.92192 A9066200234</p>
	<p>SPECCHIO RETROVISORE MANUALE REAR-VIEW MIRROR MANUAL</p> <p>COS.PEL. ref. SIMILAR ref. 505.92500 9068101993 / 9068104916 DX RH</p> <p>505.92501 9068101893 / 9068104816 SX LH</p>
	<p>SPECCHIO RETROVISORE ELETTRICO - RISCALDATO - BRACCIO CORTO REAR-VIEW MIRROR ELECTRIC - HEATED - SHORT ARM</p> <p>COS.PEL. ref. SIMILAR ref. 505.92502 9068106116 DX RH</p> <p>505.92503 9068106016 SX LH</p>
	<p>SPECCHIO RETROVISORE MANUALE - BRACCIO MEDIO REAR-VIEW MIRROR MANUAL - MEDIUM ARM</p> <p>COS.PEL. ref. SIMILAR ref. 505.92504 9068102393 / 9068105316 DX RH</p> <p>505.92505 9068102293 / 9068105216 SX LH</p>
	<p>SPECCHIO RETROVISORE ELETTRICO - RISCALDATO - BRACCIO MEDIO REAR-VIEW MIRROR ELECTRIC - HEATED - MEDIUM ARM</p> <p>COS.PEL. ref. SIMILAR ref. 505.92506 9068106516 DX RH</p> <p>505.92507 9068106416 SX LH</p>
	<p>SPECCHIO RETROVISORE MANUALE - BRACCIO LUNGO REAR-VIEW MIRROR MANUAL - LONG ARM</p> <p>COS.PEL. ref. SIMILAR ref. 505.92508 9068102793 / 9068105716 DX RH</p> <p>505.92509 9068102693 / 9068105616 SX LH</p>



	<p>SPECCHIO RETROVISORE ELETTRICO - RISCALDATO - BRACCIO LUNGO REAR-VIEW MIRROR ELECTRIC - HEATED - LONG ARM COS.PEL. ref. SIMILAR ref. 505.92510 9068106916 DX RH</p> <p>505.92511 9068106816 SX LH</p>
	<p>VETRO SPECCHIO RISCALDATO - R=1200 MIRROR GLASS HEATED - R=1200 COS.PEL. ref. SIMILAR ref. 505.92512 0028111633 DX RH</p> <p>505.92513 0028111533 SX LH</p>
	<p>VETRO SPECCHIO GRANDANGOLO - R=400 MIRROR GLASS WIDE ANGLE - R=400 COS.PEL. ref. SIMILAR ref. 505.92514 0028112033 DX RH</p> <p>505.92515 0028111933 SX LH</p>
	<p>INDICATORE DIREZIONE DIRECTION INDICATOR COS.PEL. ref. SIMILAR ref. 1605.92610 0018229020 + 0008201277 DX RH</p> <p>1605.92611 0018229320 + 0008201277 SX LH</p>
	<p>FENDINEBBIA H11 FOG LAMP H11 COS.PEL. ref. SIMILAR ref. 1605.92600 A2118200656 DX RH</p> <p>1605.92601 A2118200556 SX LH</p>
	<p>PROIETTORE SENZA FENDINEBBIA SENZA MOTORINO H7+H7 - PREDISPOSTO PER CORRETTORE ASSETTO HEADLAMP W/O FOGLAMP W/O MOTOR H7+H7 - SUITABLE FOR LOAD LEVEL ADJUSTEMENT COS.PEL. ref. SIMILAR ref. 1605.92602 - DX RH</p> <p>1605.92603 - SX LH</p>
	<p>PROIETTORE SENZA FENDINEBBIA H7+H7 - CON MOTORINO ELETTRICO HEADLAMP W/O FOGLAMP H7+H7 - WITH MOTOR COS.PEL. ref. SIMILAR ref. 1605.92604 A9068200261 DX RH</p> <p>1605.92605 A9068200161 SX LH</p>
	<p>PROIETTORE CON FENDINEBBIA SENZA MOTORINO H7+H7+H7 - PREDISPOSTO PER CORRETTORE ASSETTO HEADLAMP WITH FOGLAMP W/O MOTOR H7+H7+H7 - SUITABLE FOR LOAD LEVEL ADJUSTEMENT COS.PEL. ref. SIMILAR ref. 1605.92606 - DX RH</p> <p>1605.92607 - SX LH</p>



	<p>COFANO METALLO HOOD METAL</p> <p>COS.PEL. ref. SIMILAR ref. 105.93100 9068800257</p>
	<p>SUPPORTO FRONTALE METALLO FRONTAL BRACKET METAL</p> <p>COS.PEL. ref. SIMILAR ref. 105.93101 9068800403</p>
	<p>MODANATURA GRIGIA GREY MOULDING</p> <p>COS.PEL. ref. SIMILAR ref. 105.93102 9068880051</p>
	<p>PARAFANGO MUDGUARD</p> <p>COS.PEL. ref. SIMILAR ref. 205.93200 9068810201 DX RH</p> <p>205.93201 9068810101 SX LH</p>
	<p>PARAURTI ANTERIORE SENZA FORI SENSORI FRONT BUMPER W/O PARKING SENSOR HOLE</p> <p>COS.PEL. ref. SIMILAR ref. 405.93400 90688015709B51</p>

Sprinter 2014

COS.ME

	<p>PARAURTI ANTERIORE CON FORI SENSORI FRONT BUMPER W/ parking sensor hole, W/O washer hole & fog lamp hole (with sensor holes only)</p> <p>COS.PEL. ref. SIMILAR ref. 405.93401 90688017709B51</p>
	<p>PROIETTORE H7*2/PY21W/W21W/W5W HEADLAMP H7*2/PY21W/W21W/W5W</p> <p>COS.PEL. ref. SIMILAR ref. 1605.93600 9068202461 DX RH</p> <p>1605.93601 9068202361 SX LH</p>
	<p>FENDINEBBIA FOG LAMP</p> <p>COS.PEL. ref. SIMILAR ref. 1605.93602 9068204161 DX RH</p> <p>1605.93603 9068204061 SX LH</p>
	<p>FENDI POSTERIORE P21W REAR FOG LAMP P21W</p> <p>COS.PEL. ref. SIMILAR ref. 1605.93604 A9068200356 DX RH</p> <p>1605.93605 A9068200256 SX LH</p>
	<p>KIT PER CONNESSIONI ELETTRICHE Connettore AMP 1,5 singolo KIT FOR ELECTRICAL JOINTS Connector AMP 1,5 simple</p> <p>COS.PEL. ref. SIMILAR ref. 003120 -</p>
	<p>FANALE POSTERIORE REAR-LIGHT SENZA PORTALAMPADA WITHOUT LAMPHOLDER</p> <p>COS.PEL. ref. SIMILAR ref. 009210 A9068200264 DX RH</p> <p>009211 A9068200164 SX LH</p> <p>TRASPARENTE / LENS</p>
	<p>FANALE POSTERIORE REAR-LIGHT LED - CONNETTORE POSTERIORE AMP 1.5 LED - REAR CONNECTOR AMP 1.5</p> <p>COS.PEL. ref. SIMILAR ref. 1505.92000 A9068201764 DX RH (ex 009208) - Relativo connettore 003120 1505.92001 A9068200464 SX LH (ex 009209) - Relativo connettore 003120</p> <p>TRASPARENTE / LENS</p> <p>1503.45102 A008262156 ex 011212/009212 DX RH 1503.45103 A008262056 ex 011213/009213 SX LH</p>





	<p>PEDANA S.M.C. FOOTSTEP S.M.C.</p> <p>COS.PEL. ref. SIMILAR ref. 305.67320 6736600301</p> <p>305.67321 6736600201</p> <p style="text-align: right;">DX RH</p> <p style="text-align: right;">SX LH</p>
	<p>PARAURTI ANTERIORE P.P.G.F. - NERO FRONT BUMPER P.P.G.F. - BLACK</p> <p>COS.PEL. ref. SIMILAR ref. 405.67300 6738800170</p>









Atego

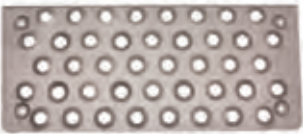

	<p>CALANDRA A.B.S. - NERO GRILLE A.B.S. - BLACK</p> <p>COS.PEL. ref. SIMILAR ref. 105.97310 A9738840185</p>
<p>AD ESAURIMENTO SCORTE UNTIL SPILL-OUT</p> 	<p>PROLUNGA POSTERIORE LATERALE LUNGO (Atego) S.M.C. - GRIGIO LONG SIDE EXTENSION MUDGUARD (for Atego) S.M.C. - GREY</p> <p>COS.PEL. ref. SIMILAR ref. 205.97305 A9738814701</p> <p style="text-align: right;">SX LH</p>
	<p>PEDANA S.M.C. - GRIGIO FOOTSTEP S.M.C. - GREY</p> <p>COS.PEL. ref. SIMILAR ref. 305.97340 A97366626017354</p> <p>305.97341 Griglia/Grille : 1005.97303 A97366625017354</p> <p style="text-align: right;">DX RH</p> <p style="text-align: right;">SX LH</p> <p style="text-align: center;">Griglia/Grille : 1005.97303</p>
	<p>PEDANA A SCALINI S.M.C. - GRIGIO FOOTSTEP S.M.C. - GREY</p> <p>COS.PEL. ref. SIMILAR ref. 305.97342 9736663201</p> <p>305.97343 Griglia/Grille : 1005.97304 sup. - 1005.97306 inf. 9736663101</p> <p style="text-align: right;">DX RH</p> <p style="text-align: right;">SX LH</p> <p style="text-align: center;">Griglia/Grille : 1005.97304 sup. - 1005.97305 inf.</p>
	<p>PARAURTI CENTRALE BASSO P.P.G.F. - GRIGIO CENTRE BUMPER P.P.G.F. - GREY</p> <p>COS.PEL. ref. SIMILAR ref. 405.97380 A97388010707354</p>

 <p>cm 38</p>	<p>ANGOLO PARAUTI P.P.G.F. - GRIGIO CORNER BUMPER P.P.G.F. - GREY COS.PEL. ref. SIMILAR ref. 405.97382 A97388005707354 DX RH</p> <p>405.97381 A97388004707354 SX LH</p>
 <p>cm 41</p>	<p>PARAUTI CENTRALE ALTO P.P.G.F. - GRIGIO UPPER CENTRAL BUMPER P.P.G.F. - GREY COS.PEL. ref. SIMILAR ref. 405.97390 A97388011707354</p>
 <p>cm 48</p>	<p>ANGOLO PARAUTI P.P.G.F. - GRIGIO CORNER BUMPER P.P.G.F. - GREY COS.PEL. ref. SIMILAR ref. 405.97392 A97388017707354 DX RH</p> <p>405.97391 A97388016707354 SX LH</p>
	<p>SPECCHIO GUARDARUOTA MANUALE ROOF MIRROR MANUAL COS.PEL. ref. SIMILAR ref. 505.12231 0028106016</p>
	<p>SPECCHIO FRONTALE CON BRACCIO 24V FRONT VISION MIRROR WITH ARM 24V 24V COS.PEL. ref. SIMILAR ref. 505.94010 9408105516 DX RH</p>
	<p>SPECCHIO FRONTALE CON BRACCIO CAB. ALTA 24V - CABINA ALTA FRONT MIRROR WITH ARM 24V - HIGH CAB COS.PEL. ref. SIMILAR ref. 505.94324 9408107316</p>
	<p>SPECCHIO GUARDARUOTA MANUALE ROOF MIRROR MANUAL COS.PEL. ref. SIMILAR ref. 505.94327 9418102116 / A9418101016 Modelli dal 10/2004 - Models from 10/2004 on</p>
	<p>SPECCHIO RETROVISORE ELETTRICO + RISCALDATO REAR-VIEW MIRROR ELECTRIC + HEATED COS.PEL. ref. SIMILAR ref. 505.97350 0008102179 DX RH</p> <p>505.97351 0008102079 SX LH 2a serie / 2nd series 2a serie / 2nd series</p>

	<p>SPECCHIO RETROVISORE ELETTRICO + RISCALDATO REAR-VIEW MIRROR ELECTRIC + HEATED COS.PEL. ref. 505.97352 SIMILAR ref. A0008101579 DX RH</p> <p>505.97353 1a serie / 1st series A0008101879 SX LH 1a serie / 1st series</p>
	<p>SPECCHIO RETROVISORE MANUALE + RISCALDATO REAR-VIEW MIRROR MANUAL + HEATED COS.PEL. ref. 505.97354 SIMILAR ref. 0008102479 DX-SX RH-LH</p> <p>2a serie / 2nd series</p>
	<p>SPECCHIO RETROVISORE MANUALE + RISCALDATO REAR-VIEW MIRROR MANUAL + HEATED COS.PEL. ref. 505.97355 SIMILAR ref. A0008101679 DX-SX RH-LH</p> <p>1a serie / 1st series</p>
	<p>VETRO SPECCHIO RISCALDATO MIRROR GLASS HEATED COS.PEL. ref. 505.97356 SIMILAR ref. A0018119933 DX-SX RH-LH</p> <p>1a serie / 1st series</p>
	<p>VETRO SPECCHIO RISCALDATO MIRROR GLASS HEATED COS.PEL. ref. 505.97357 SIMILAR ref. A0028110033 DX-SX RH-LH</p> <p>1a serie / 1st series</p>
	<p>VETRO SPECCHIO RISCALDATO MIRROR GLASS HEATED COS.PEL. ref. 505.97358 SIMILAR ref. A0028114633 DX-SX RH-LH</p> <p>2a serie / 2nd series</p>
	<p>VETRO SPECCHIO RISCALDATO MIRROR GLASS HEATED COS.PEL. ref. 505.97359 SIMILAR ref. A0028114733 DX-SX RH-LH</p> <p>2a serie / 2nd series</p>
	<p>VISIERA TETTO BASSO / SENZA SPECCHIO FRONTALE SUN VISOR LOW CAB / WITHOUT FRONT MIRROR COS.PEL. ref. 705.97300 SIMILAR ref. 9738110410</p> <p>Relativo kit staffe 1005.97300</p>

	<p>VISIERA ATEGO 2a SERIE TETTO BASSO SUN VISOR ATEGO 2a SERIES LOW ROOF</p> <p>COS.PEL. ref. SIMILAR ref. 705.97301 9738110710</p> <p>Relativo kit staffe 1005.97301</p>
	<p>PANNELLO ANGOLARE CORNER PANEL</p> <p>COS.PEL. ref. SIMILAR ref. 905.97312 9738840223 DX RH</p> <p>905.97311 9738840123 SX LH</p>
	<p>SUPPORTO PARAURTI BUMPER BRACKET</p> <p>COS.PEL. ref. SIMILAR ref. 1005.97000 9705253539 DX RH</p> <p>1005.97001 9705253439 SX LH</p>
	<p>COPRI BATTERIE BATTERY COVER</p> <p>COS.PEL. ref. SIMILAR ref. 1005.97302 3755410103</p>
	<p>GRIGLIA PEDANA FOOTSTEP GRILLE</p> <p>COS.PEL. ref. SIMILAR ref. 1005.97303 9736661328 DX-SX RH-LH</p>
	<p>GRIGLIA PEDANA SUPERIORE UPPER FOOTSTEP GRILLE</p> <p>COS.PEL. ref. SIMILAR ref. 1005.97304 9736661428 DX-SX RH-LH</p>
	<p>GRIGLIA PEDANA INFERIORE LOWER FOOTSTEP GRILLE</p> <p>COS.PEL. ref. SIMILAR ref. 1005.97306 9736661628 DX RH</p> <p>1005.97305 9736661528 SX LH</p>
 	<p>FANALINO LATERALE P21W CORNER LAMP P21W COS.PEL. ref. SIMILAR ref. 1605.97300 9738200421 DX RH</p> <p>1605.97301 9738200321 SX LH</p>

Atego

COS.ME

 	<p>FANALINO ANTERIORE PY21W CORNER LAMP PY21W COS.PEL. ref. SIMILAR ref. 1605.97302 9738200621 DX RH</p> <p>1605.97303 9738200521 SX LH</p>
 	<p>LUCE DIREZIONE PY21W CONER LAMP PY21W COS.PEL. ref. SIMILAR ref. 1605.97310 A9738200221 DX RH</p> <p>1605.97311 A9738200121 SX LH</p>
 	<p>LUCE DIREZIONE 13 -> PY21W P21W SIGNAL LIGHT 13 -> PY21W P21W COS.PEL. ref. SIMILAR ref. 1605.97312 9678200221 DX RH</p> <p>1605.97313 9678200121 SX LH</p>
 	<p>FANALINO LATERALE P21W SIDE LAMP P21W COS.PEL. ref. SIMILAR ref. 1605.97318 9678201221 DX RH</p> <p>1605.97319 9678201121 SX LH</p>
 	<p>PROIETTORE CON FENDI H4 H1 W5W - PREDIS. PER COR.ASSETTO - CON MOTORINO HEADLAMP WITH FOG LAMP H4 H1 W5W - SUIT. FOR LOAD LEVEL ADJ. - WITH MOTOR COS.PEL. ref. SIMILAR ref. 1605.97304 9738200661 DX RH</p> <p>1605.97305 9738200561 SX LH</p>
 	<p>PROIETTORE H4 W5W - PREDIS.PER CORR.ASS. - SENZA MOTORINO HEADLAMP H4 W5W - SUIT. FOR LOAD LEVEL ADJ. - W/O MOTOR COS.PEL. ref. SIMILAR ref. 1605.97306 9738200261 DX RH</p> <p>1605.97307 9738200161 SX LH</p>
 	<p>PROIETTORE H7 H1 H1 W5W - PRED. PER CORR. ASSETTO - CON MOTORINO HEADLAMP H7 H1 H1 W5W - SUIT. FOR LOAD LEVEL ADJ. - WITH MOTOR COS.PEL. ref. SIMILAR ref. 1605.97308 9738202961 DX RH</p> <p>1605.97309 9738202861 SX LH</p>
 	<p>PROIETTORE -> 12 - H7 H1 H1 W5W - PRED. PER CORR. ASSETTO - CON FENDINEBBIA HEADLAMP -> 12 - H7 H1 H1 W5W - SUIT. FOR LOAD LEVEL ADJ. - WITH FOG LAMP COS.PEL. ref. SIMILAR ref. 1605.97314 A9738202761 DX RH</p> <p>1605.97315 A9738202661 SX LH</p>

	<p>PROIETTORE -> 12 - H7 H1 H1 W5W - PRED. PER CORR. ASSETTO - SENZA FENDINEBBIA HEADLAMP -> 12 - H7 H1 H1 W5W - SUIT. FOR LOAD LEVEL ADJ. - W/O FOG LAMP COS.PEL. ref. SIMILAR ref. 1605.97316 A9738202561 DX RH</p> <p>1605.97317 A9738202461 SX LH</p>
	<p>MANIGLIA PORTA SENZA CHIAVE DOOR HANDLE WITHOUT KEY COS.PEL. ref. SIMILAR ref. 1705.97310 0007601359 DX-SX RH-LH</p>
	<p>ALZACRISTALLI ELETTRICO - CON MOTORINO - 2 FILI WINDOW REGULATOR ELECTRIC - WITH MOTOR - 2 WIRES COS.PEL. ref. SIMILAR ref. 1905.97350 9737200446 DX RH</p> <p>1905.97351 9737200346 SX LH</p>
	<p>DEFLETTORI LATERALI CON CLIPS SIDEWINDOW DEFLECTORS WITH CLIPS COS.PEL. ref. SIMILAR ref. 3005.00002 -</p>
	<p>FANALE POSTERIORE 7 FUNZIONI REAR-LIGHT 7 FUNCTIONS COS.PEL. ref. SIMILAR ref. 005780 A0035445703 DX RH</p> <p>005790 A0035445303 SX LH Con luce targa / With plate light</p> <p>TRASPARENTE / LENS 011241 A0025444790 DX-SX RH-LH</p>

Cabina 641



COS.ME

	<p>GRIGLIA A.B.S. - NERO GRILLE A.B.S. - BLACK</p> <p>COS.PEL. ref. 105.64100 SIMILAR ref. A6417500618</p>
	<p>GRIGLIA S.M.C. - NERO GRILLE S.M.C. - BLACK</p> <p>COS.PEL. ref. 105.64101 SIMILAR ref. 6417501009</p>
	<p>SUPPORTO GRIGLIA METALLO GRILLE SUPPORT STEEL</p> <p>COS.PEL. ref. 105.64102 SIMILAR ref. 5007501602 / 6417500002</p>
	<p>PARAFANGO LATERALE STRATIFICAZIONE MANUALE - GRIGIO MUDGUARD G.R.P. - GREY</p> <p>COS.PEL. ref. 205.10300 SIMILAR ref. 6418810301 DX RH</p> <p>205.10201 6418810201 SX LH</p>
<p>AD ESAURIMENTO SCORTE UNTIL SELL-OUT</p> 	<p>PARAURTI CENTRALE S.M.C. - GRIGIO - (880mm) CENTRAL BUMPER S.M.C. - GREY - (880mm)</p> <p>COS.PEL. ref. 405.00270 SIMILAR ref. 6418800270</p>

	<p>PARAURTI ANTERIORE S.M.C. - GRIGIO FRONT BUMPER S.M.C. - GREY COS.PEL. ref. SIMILAR ref. 405.00472 6418800473 DX RH</p> <p>405.00471 6418809970 SX LH</p>
	<p>SOTTOPARAURTI S.M.C. - (2360mm) - GRIGIO SPOILER S.M.C. - (2360mm) - GREY COS.PEL. ref. SIMILAR ref. 405.00236 6418800236</p>
	<p>SPECCHIO RETROVISORE REAR-VIEW MIRROR COS.PEL. ref. SIMILAR ref. 505.64110 6418104216 DX-SX RH-LH</p>
	<p>SPECCHIO RETROVISORE GRANDANGOLO REAR-VIEW MIRROR WIDE ANGLE COS.PEL. ref. SIMILAR ref. 505.64111 6418104616</p>
	<p>SPECCHIO GUARDARUOTA BRACCIO 206 MM. ROOF MIRROR ARM 206 MM. COS.PEL. ref. SIMILAR ref. 505.64112 6418104716</p>
	<p>RIVESTIMENTO PORTA DOOR INNER PANEL COS.PEL. ref. SIMILAR ref. 1405.64150 6417201271 DX RH</p> <p>1405.64151 6417201171 SX LH</p>
<p>AD ESAURIMENTO SCORTE UNTIL STILL-OUT</p> 	<p>ALZACRISTALLI MANUALE WINDOW REGULATOR MANUAL COS.PEL. ref. SIMILAR ref. 1905.64100 6417200346 DX RH</p>
	<p>FANALE POSTERIORE 7 FUNZIONI REAR-LIGHT 7 FUNCTIONS COS.PEL. ref. SIMILAR ref. 005630 0015402670 / A0015401470 DX RH Relatico connettore 003120 005640 0015402770 / A0015402870 SX LH Con luce targa / With plate light - conn. 003120 TRASPARENTE / LENS 011171 A0025440790 DX RH 011181 A0025441290 SX LH</p>

Cabina 649



	<p>GRIGLIA A.B.S. - NERO GRILLE A.B.S. - BLACK</p> <p>COS.PEL. ref. 105.64900 SIMILAR ref. 6497500118</p>
<p>AD ESAURIMENTO SCORTE UNTIL SPILL-OUT</p> 	<p>PARAFANGO LATERALE STRATIFICAZIONE MANUALE - GRIGIO MUDGUARD G.R.P. - GREY</p> <p>COS.PEL. ref. 205.10100 SIMILAR ref. 6498810101 DX RH</p> <p>205.10101 6498810001 SX LH</p>
	<p>CALOTTA PARAF. POSTER. R 1a SERIE CON 4 TIRANTI A.B.S. - NERO - 12-99 REAR MUDGUARD 1ST SERIES WITH 4 M. TENSIONERS A.B.S. - BLACK - 12-99</p> <p>COS.PEL. ref. 201.32440 SIMILAR ref. 6625200019 / 9415220167 / 9445220167 DX-SX RH-LH (201.32441 versione senza i tiranti)</p>
	<p>CALOTTA PARAFANGO POSTERIORE A.B.S. - NERO - 12-99 - 1a serie REAR MUDGUARD A.B.S. - BLACK - 12-99 - 1st series</p> <p>COS.PEL. ref. 201.32441 SIMILAR ref. 6625200019 DX-SX RH-LH Tirante : 1001.23641 - (201.32440 versione con i tiranti)</p>
	<p>PEDANA S.M.C. - GRIGIO FOOTSTEP S.M.C. - GREY</p> <p>COS.PEL. ref. 305.64930 SIMILAR ref. A6496600106 DX RH</p> <p>305.64931 A6496600006 SX LH</p>

	<p>PARAURTI CENTRALE R.T.M. - GRIGIO - (960mm) CENTRAL BUMPER R.T.M. - GREY - (960mm)</p> <p>COS.PEL. ref. SIMILAR ref. 405.00070 6498800070</p>
	<p>PARAURTI ANTERIORE S.M.C. - GRIGIO FRONT BUMPER S.M.C. - GREY</p> <p>COS.PEL. ref. SIMILAR ref. 405.00472 6418800473</p> <p>405.00471 6418809970</p> <p style="text-align: right;">DX RH SX LH</p>
<p>AD ESAURIMENTO SCORTE UNTIL SELL-OUT</p> 	<p>SOTTOPARAURTI R.T.M. - GRIGIO - (2450mm) SPOILER R.T.M. - GREY - (2450mm)</p> <p>COS.PEL. ref. SIMILAR ref. 405.00136 6498800136</p>
	<p>SOTTOPARAURTI STRATIFICAZIONE MANUALE - GRIGIO - (2500MM) SPOILER G.R.P. - GREY - (2500MM)</p> <p>COS.PEL. ref. SIMILAR ref. 405.64988 6498800736</p>
	<p>SPECCHIO RETROVISORE REAR-VIEW MIRROR</p> <p>COS.PEL. ref. SIMILAR ref. 505.64110 6418104216</p> <p style="text-align: right;">DX-SX RH-LH</p>
	<p>SPECCHIO RETROVISORE GRANDANGOLO REAR-VIEW MIRROR WIDE ANGLE</p> <p>COS.PEL. ref. SIMILAR ref. 505.64111 6418104616</p>
	<p>SPECCHIO GUARDARUOTA BRACCIO 206 MM. ROOF MIRROR ARM 206 MM.</p> <p>COS.PEL. ref. SIMILAR ref. 505.64112 6418104716</p>
	<p>CONVOGLIATORE ARIA A.B.S. - NERO AIR CONVEYOR A.B.S. - BLACK</p> <p>COS.PEL. ref. SIMILAR ref. 905.64990 A6416201436</p> <p>905.64991 A6416201536</p> <p style="text-align: right;">DX RH SX LH</p>



	<p>PROLUNGA PARAFANGO LATERALE S.M.C. - GRIGIO EXTENSION MUDGUARD S.M.C. - GREY COS.PEL. ref. SIMILAR ref. 205.94080 9408900625-7354 DX RH</p> <p>205.94081 9408900525-7354 SX LH</p>
	<p>COPERCHIO PROLUNGA S.M.C. - GRIGIO COVER EXTENSION S.M.C. - GREY COS.PEL. ref. SIMILAR ref. 205.94082 A9408900676-7354 DX RH</p> <p>205.94083 A9408900576-7354 SX LH</p>
	<p>PASSARUOTA FRONT WHELL FENDER COS.PEL. ref. SIMILAR ref. 205.94084 9408812901-7354 DX RH</p> <p>205.94085 9448812801-7354 SX LH</p>
	<p>CALOTTA PARAFANGO POSTERIORE BASSA 2a serie - P.P.T. - GRIGIO REAR MUDGUARD LOW CAB 2nd series - P.P.T. - GREY COS.PEL. ref. SIMILAR ref. 205.20007 9305200007 DX-SX RH-LH</p> <p>Relativo tirante 1005.00003 - (205.20006 versione con i tiranti)</p>
	<p>CALOTTA PARAFANGO POSTERIORE ALTA 3a serie - P.P.T. - GRIGIO REAR MUDGUARD HIGH CAB 3rd series - P.P.T. - GREY COS.PEL. ref. SIMILAR ref. 205.20008 9305200207 DX-SX RH-LH</p> <p>Relativo tirante 1005.00003 - (205.20009 versione con i tiranti)</p>

	<p>MEZZO PARAFANGO POSTERIORE PARTE ANT. CON STAFFE - 2a/3a Serie REAR MUDGUARD FRONT PART WITH BRACKETS - 2nd/3th Series COS.PEL. ref. SIMILAR ref. 205.20010 9305200119 DX RH</p> <p>205.20011 9305200019 SX LH</p>
	<p>MEZZO PARAFANGO POSTERIORE 2a/3a serie CON STAFFE - CON RIPARO ANTISPRAY 205.94312 REAR HALF MUDGUARD 2nd/3th SERIES WITH BRACKETS - WITH COVER ANTISPRAY 205.94312 COS.PEL. ref. SIMILAR ref. 205.20014 9305200120 / 9305200820 DX-SX RH-LH</p>
	<p>PEDANA PARAFANGO S.M.C. - GRIGIO FOOTSTEP S.M.C. - GREY COS.PEL. ref. SIMILAR ref. 305.94000 9446661401-7354 DX RH</p> <p>305.94001 9446661301-7354 SX LH</p>
	<p>PEDANA S.M.C. - GRIGIO FOOTSTEP S.M.C. - GREY COS.PEL. ref. SIMILAR ref. 305.94002 9406662501 DX RH</p> <p>305.94003 9406662401 SX LH Griglia/Grille: 1005.94001 sup Griglia/Grille: 1005.94001 sup</p>
	<p>PEDANA SALITA S.M.C. - GRIGIO FOOTSTEP S.M.C. - GREY COS.PEL. ref. SIMILAR ref. 305.94004 9406600201 / 9406604801 / 9406660201 DX RH</p> <p>305.94005 9406600101 / 9406604701 / 9406660101 SX LH Griglia/Grille: 1005.94001 sup Griglia/Grille: 1005.94001 sup</p>
	<p>PEDANA SALITA S.M.C. - GRIGIO FOOTSTEP S.M.C. - GREY COS.PEL. ref. SIMILAR ref. 305.94006 9406601201 / 9406660601 DX RH</p> <p>305.94007 9406601101 / 9406660501 SX LH Griglia/Grille: 1005.94001 sup Griglia/Grille: 1005.94001 sup</p>
	<p>PEDANA SALITA GRIGIO FOOTSTEP GREY COS.PEL. ref. SIMILAR ref. 305.94008 9446660201 DX RH</p> <p>305.94009 9446660101 SX LH Griglia/Grille: 1005.94001 sup Griglia/Grille: 1005.94001 sup</p>
	<p>COPERCHIO PEDANA SALITA FOOTSTEP COVER COS.PEL. ref. SIMILAR ref. 305.94010 9406660005-7C72</p>

	<p>PEDANA SALITA FOOTSTEP</p> <p>COS.PEL. ref. 305.94012 SIMILAR ref. 9446660401-7354 DX RH</p> <p>305.94011 Griglia/Grille: 1005.94001 sup 9446660301-7354 SX LH</p> <p>Griglia/Grille: 1005.94001 sup</p>
	<p>ANGOLO PARAURTI ALTO - S.M.C. - GRIGIO CORNER BUMPER HIGH - S.M.C. - GREY</p> <p>COS.PEL. ref. 405.94008 SIMILAR ref. 9448802404 DX RH</p> <p>405.94009 9448800104 SX LH</p>
	<p>ANGOLO PARAURTI S.M.C. - GRIGIO CORNER BUMPER S.M.C. - GREY</p> <p>COS.PEL. ref. 405.94010 SIMILAR ref. 9448800370 DX RH</p> <p>405.94011 9448800270 SX LH</p>
	<p>LONGHERINA CENTRALE PARAURTI ALTO LOWER GRILLE</p> <p>COS.PEL. ref. 405.94020 SIMILAR ref. 9448850774</p>
	<p>LONGHERINA LOWER GRILLE</p> <p>COS.PEL. ref. 405.94022 SIMILAR ref. 9448850674 DX RH</p> <p>405.94021 9448850574 SX LH</p>
	<p>GRIGLIA PARAURTI CENTRALE CENTRAL BUMPER GRILLE</p> <p>COS.PEL. ref. 405.94023 SIMILAR ref. 9408850122</p>
	<p>GRIGLIA PARAURTI BUMPER GRILLE</p> <p>COS.PEL. ref. 405.94024 SIMILAR ref. 9408850422 DX RH</p> <p>405.94025 9408850322 SX LH</p>
	<p>PARAURTI CENTRALE S.M.C. - GRIGIO CENTRE BUMPER S.M.C. - GREY</p> <p>COS.PEL. ref. 405.94102 SIMILAR ref. 9418851401</p>

	<p>ANGOLO SOTTOPARAURTI P.P. - GRIGIO CORNER SPOILER P.P. - GREY COS.PEL. ref. SIMILAR ref. 405.94014 9408850225</p> <p>405.94013 9408850125</p> <p style="text-align: right;">DX RH</p> <p style="text-align: right;">SX LH</p>
	<p>ANGOLO SOTTOPARAURTI P.P. - GRIGIO CORNER SPOILER P.P. - GREY COS.PEL. ref. SIMILAR ref. 405.94016 9448850125</p> <p>405.94017 9448850725</p> <p style="text-align: right;">DX RH</p> <p style="text-align: right;">SX LH</p>
	<p>ANGOLO SOTTOPARAURTI CON FORI - P.P. - GRIGIO CORNER SPOILER WITH HOLES - P.P. - GREY COS.PEL. ref. SIMILAR ref. 405.94018 9448850625</p> <p>405.94019 9448850525</p> <p style="text-align: right;">DX RH</p> <p style="text-align: right;">SX LH</p>
	<p>SOTTOPARAURTI CENTRALE P.P. - GRIGIO CENTRAL BUMPER P.P. - GREY COS.PEL. ref. SIMILAR ref. 405.94110 9418850922</p>
	<p>SPECCHIO FRONTALE CON BRACCIO 24V FRONT VISION MIRROR WITH ARM 24V 24V COS.PEL. ref. SIMILAR ref. 505.94010 9408105516</p> <p style="text-align: right;">DX RH</p>
	<p>SPECCHIO FRONTALE CON BRACCIO CAB. ALTA 24V - CABINA ALTA FRONT MIRROR WITH ARM 24V - HIGH CAB COS.PEL. ref. SIMILAR ref. 505.94324 9408107316</p>
	<p>SPECCHIO GUARDARUOTA MANUALE ROOF MIRROR MANUAL COS.PEL. ref. SIMILAR ref. 505.94327 9418102116 / A9418101016</p> <p style="text-align: right;">Modelli dal 10/2004 - Models from 10/2004 on</p>
	<p>SPECCHIO RETROVISORE ELETTRICO + RISCALDATO REAR-VIEW MIRROR ELECTRIC + HEATED COS.PEL. ref. SIMILAR ref. 505.97350 0008102179</p> <p>505.97351 0008102079</p> <p style="text-align: right;">DX RH</p> <p style="text-align: right;">SX LH</p> <p style="text-align: right;">2a serie / 2nd series 2a serie / 2nd series</p>

	<p>SPECCHIO RETROVISORE ELETTRICO + RISCALDATO REAR-VIEW MIRROR ELECTRIC + HEATED</p> <p>COS.PEL. ref. 505.97352 SIMILAR ref. A0008101579 DX RH</p> <p>505.97353 1a serie / 1st series A0008101879 SX LH 1a serie / 1st series</p>
	<p>SPECCHIO RETROVISORE MANUALE + RISCALDATO REAR-VIEW MIRROR MANUAL + HEATED</p> <p>COS.PEL. ref. 505.97354 SIMILAR ref. 0008102479 DX-SX RH-LH</p> <p>2a serie / 2nd series</p>
	<p>SPECCHIO RETROVISORE MANUALE + RISCALDATO REAR-VIEW MIRROR MANUAL + HEATED</p> <p>COS.PEL. ref. 505.97355 SIMILAR ref. A0008101679 DX-SX RH-LH</p> <p>1a serie / 1st series</p>
	<p>VETRO SPECCHIO RISCALDATO MIRROR GLASS HEATED</p> <p>COS.PEL. ref. 505.97356 SIMILAR ref. A0018119933 DX-SX RH-LH</p> <p>1a serie / 1st series</p>
	<p>VETRO SPECCHIO RISCALDATO MIRROR GLASS HEATED</p> <p>COS.PEL. ref. 505.97357 SIMILAR ref. A0028110033 DX-SX RH-LH</p> <p>1a serie / 1st series</p>
	<p>VETRO SPECCHIO RISCALDATO MIRROR GLASS HEATED</p> <p>COS.PEL. ref. 505.97358 SIMILAR ref. A0028114633 DX-SX RH-LH</p> <p>2a serie / 2nd series</p>
	<p>VETRO SPECCHIO RISCALDATO MIRROR GLASS HEATED</p> <p>COS.PEL. ref. 505.97359 SIMILAR ref. A0028114733 DX-SX RH-LH</p> <p>2a serie / 2nd series</p>
	<p>VISIERA TETTO ALTO CON SPECCHIO FRONTALE Fino al 2004 TOP ROOF SUN VISION WITH FRONT MIRROR Until 2004</p> <p>COS.PEL. ref. 705.94010 SIMILAR ref. 9738110810</p> <p>Relativo kit staffe 1005.94010</p>

 <p>cm 203 cm 21 cm 55 cm 21</p>	<p>VISIERA TETTO ALTO SENZA SPECCHIO FRONTALE Fino al 2004 TOP ROOF SUN VISION WITHOUT FRONT MIRROR Until 2004</p> <p>COS.PEL. ref. SIMILAR ref. 705.94011 9738110510</p> <p>Relativo kit staffe 1005.94010</p>
	<p>CONVOGLIATORE ARIA PARTE INTERNA NERO INNER CORNER PANEL BLACK</p> <p>COS.PEL. ref. SIMILAR ref. 905.94090 9448840122 / 9448840722</p> <p>905.94091 9448840022</p> <p>DX RH SX LH</p>
	<p>CONVOGLIATORE ARIA PARTE ESTERNA EXTERIOR CORNER PANEL</p> <p>COS.PEL. ref. SIMILAR ref. 905.94092 9448840322</p> <p>905.94093 9448840222</p> <p>DX RH SX LH</p>
	<p>CONVOGLIATORE ARIA PARTE ESTERNA EXTERIOR CORNER PANEL</p> <p>COS.PEL. ref. SIMILAR ref. 905.94094 9448840522</p> <p>905.94095 9448840422</p> <p>DX RH DX RH</p>
	<p>GRIGLIA INFERIORE PEDANA FOOTSTEP LOWER</p> <p>COS.PEL. ref. SIMILAR ref. 1005.94000 9406660428</p>
	<p>GRIGLIA SUPERIORE PEDANA FOOTSTEP UPPER</p> <p>COS.PEL. ref. SIMILAR ref. 1005.94001 9406660128</p>
	<p>SUPPORTO PEDANA FOOTSTEP BRACKET</p> <p>COS.PEL. ref. SIMILAR ref. 1005.94002 9406601930</p> <p>1005.94003 9406601830</p> <p>DX RH SX LH</p>
 	<p>FANALINO PY21W CORNER LAMP PY21W</p> <p>COS.PEL. ref. SIMILAR ref. 1605.94062 9408200421</p> <p>1605.94063 9408200321</p> <p>DX RH SX LH</p>

 	<p>FANALINO P21 5W CORNER LAMP P21 5W</p> <p>COS.PEL. ref. SIMILAR ref. 1605.94064 0008200777 / 9408200221 DX-SX RH-LH</p> <p>Relativo portalampada 1605.94067</p>
	<p>PORTALAMPADA BULB HOLDER</p> <p>COS.PEL. ref. SIMILAR ref. 1605.94067 -</p> <p>Per lampada / For lamp : 1605.94064</p>
 	<p>PROIETTORE ELETTRICO HEADLAMP ELECTRIC</p> <p>COS.PEL. ref. SIMILAR ref. 1605.94058 A9408200461 DX RH</p> <p>1605.94059 A9408200361 SX LH</p>
 	<p>PROIETTORE H7 H1 - CORRETTORE ASSETTO MANUALE HEADLAMP H7 H1 - MANUAL LOAD LEVEL ADJUSTEMENT</p> <p>COS.PEL. ref. SIMILAR ref. 1605.94060 9408200261 DX RH</p> <p>1605.94061 9408200161 SX LH</p>
 	<p>PROIETTORE FENDINEBBIA H3 FOG LAMP H3</p> <p>COS.PEL. ref. SIMILAR ref. 1605.94066 9408200156 DX RH</p> <p>1605.94065 9408200056 SX LH</p>
	<p>ALZACRISTALLI ELETTRICO - CON MOTORINO - 2 FILI WINDOW REGULATOR ELECTRIC - WITH MOTOR - 2 WIRES</p> <p>COS.PEL. ref. SIMILAR ref. 1905.97350 9737200446 DX RH</p> <p>1905.97351 9737200346 SX LH</p>
	<p>VASCHETTA ESPANSIONE EXPANSION TANK</p> <p>COS.PEL. ref. SIMILAR ref. 2105.94080 A9405010003</p>
	<p>MOLLA A GAS Lunghezza [mm] 609 Corsa [mm] 262 Forza scarto [N] 360 GAS SPRING Lenght [mm] 609 Stroke [mm] 262 Waste force [N] 360</p> <p>COS.PEL. ref. SIMILAR ref. 2405.94100 A0019808464</p>

	<p>DEFLETTORI LATERALI CON CLIPS SIDEWINDOW DEFLECTORS WITH CLIPS</p> <p>COS.PEL. ref. SIMILAR ref. 3005.00002 -</p>
---	---

ActrosMP1/MegaSpaceMP1



	<p>GRIGLIA SUPERIORE S.M.C. - GRIGIO UPPER FRONT PANEL S.M.C. - GREY</p> <p>COS.PEL. ref. SIMILAR ref. 105.11219 9417500009</p>
	<p>COPERCHIO PARAFANGO POSTERIORE MUDGUARD COVER</p> <p>COS.PEL. ref. SIMILAR ref. 205.19998 9415240129 DX RH</p> <p>205.19999 9415240029 SX LH</p>
	<p>PARAFANGO RUOTA ANT. PARTE POST. FRONT WHEEL MUDGUARD REAR</p> <p>COS.PEL. ref. SIMILAR ref. 205.94100 9418811601 DX RH</p> <p>205.94101 9418811501 SX LH</p>
	<p>MEZZO PARAFANGO POSTERIORE PARTE POST. REAR MUDGUARD REAR PART</p> <p>COS.PEL. ref. SIMILAR ref. 205.20000 9415201620 DX RH</p> <p>205.20001 9415200320 SX LH</p>
	<p>MEZZO PARAFANGO POSTERIORE PARTE ANT. REAR MUDGUARD FRONT PART</p> <p>COS.PEL. ref. SIMILAR ref. 205.20002 A9415200219 DX RH</p> <p>205.20003 A9415200119 SX LH</p>

ActrosMP1/MegaSpaceMP1

	<p>CALOTTA PARAFANGO POSTERIORE P.P.T. - GRIGIO REAR MUDGUARD P.P.T. - GREY</p> <p>COS.PEL. ref. SIMILAR ref. 205.20004 9415220004 DX-SX RH-LH</p> <p>Relativo tirante 1001.23641 - (205.20005 versione con i tiranti)</p>
	<p>CALOTTA PARAFANGO POSTER. CON 6 TIRANTI P.P.T. - GRIGIO REAR MUDGUARD WITH 6 M. TENSIONERS P.P.T. - GREY</p> <p>COS.PEL. ref. SIMILAR ref. 205.20005 9415220004 / 9415220167 / 9445220167 DX-SX RH-LH (205.20004 versione senza i tiranti)</p>
	<p>PEDANA PARAFANGO S.M.C. - GRIGIO MUDGUARD FOOTSTEP S.M.C. - GREY</p> <p>COS.PEL. ref. SIMILAR ref. 305.94104 9416662001 / 9436663901 DX RH</p> <p>305.94105 9416661901 / 9436663801 SX LH</p> <p>Griglia/Grille : 1005.94300 inf - 1005.94305 sup Griglia/Grille : 1005.94300 inf - 1005.94305 sup</p>
	<p>PEDANA FOOTSTEP A.B.S. - GRIGIO A.B.S. - GREY</p> <p>COS.PEL. ref. SIMILAR ref. 305.94100 9416600101 / 9416600301 DX RH</p> <p>305.94101 9416600001 / 9416600201 SX LH</p>
	<p>PEDANA FOOTSTEP A.B.S. - GRIGIO A.B.S. - GREY</p> <p>COS.PEL. ref. SIMILAR ref. 305.94102 9416600501 DX RH</p> <p>305.94103 9416600401 SX LH</p>
	<p>PEDANA FOOTSTEP MEGA SPACE - S.M.C. - GRIGIO MEGA SPACE - S.M.C. - GREY</p> <p>COS.PEL. ref. SIMILAR ref. 305.94106 9416662201 / 9436660501 / 9436664301 DX RH</p> <p>305.94107 9416662101 / 9436660401 / 9436664201 SX LH</p> <p>Griglia/Grille: 1005.94302 inf - 1005.94304 sup Griglia/Grille: 1005.94303 inf - 1005.94304 sup</p>
	<p>ANGOLO PARAURTI S.M.C. - GRIGIO CORNER BUMPER S.M.C. - GREY</p> <p>COS.PEL. ref. SIMILAR ref. 405.94100 9418801070 DX RH</p> <p>405.94101 9418800970 SX LH</p>
	<p>PARAURTI CENTRALE S.M.C. - GRIGIO CENTRAL BUMPER S.M.C. - GREY</p> <p>COS.PEL. ref. SIMILAR ref. 405.94102 9418851401</p>

ActrosMP1/MegaSpaceMP1

 <p>cm 55</p>	<p>ANGOLO PARAURTI CON FORO LAVAFARI - S.M.C. - GRIGIO CORNER BUMPER WITH HOLES - S.M.C. - GREY COS.PEL. ref. SIMILAR ref. 405.94104 9418802470 DX RH</p> <p>405.94103 9418802370 SX LH</p>
 <p>cm 87</p>	<p>ANGOLO PARAURTI S.M.C. - GRIGIO CORNER BUMPER S.M.C. - GREY COS.PEL. ref. SIMILAR ref. 405.94106 9418802870 DX RH</p> <p>405.94105 9418802770 SX LH</p>
	<p>SOTTOPARAURTI CENTRALE P.P. - GRIGIO CENTRAL BUMPER P.P. - GREY COS.PEL. ref. SIMILAR ref. 405.94110 9418850922</p>
	<p>ANGOLO SOTTOPARAURTI P.P. - GRIGIO CORNER SPOILER P.P. - GREY COS.PEL. ref. SIMILAR ref. 405.94112 9418850925-7C72 DX RH</p> <p>405.94111 9418850825-7C72 SX LH</p>
	<p>SOTTOPARAURTI CENTRALE P.P. - NERO CENTRAL SPOILER P.P. - BLACK COS.PEL. ref. SIMILAR ref. 405.94113 9418853822</p>
	<p>ANGOLO SOTTOPARAURTI A.B.S. - NERO - MEGA SPACE MP1 CORNER SPOILER A.B.S. - BLACK - MEGA SPACE MP1 COS.PEL. ref. SIMILAR ref. 405.94114 9418853522 DX RH</p> <p>405.94115 9418853422 SX LH</p>
	<p>PARAURTI CENTRALE INFERIORE METALLO CENTRAL SIDE BUMPER PART STEEL COS.PEL. ref. SIMILAR ref. 405.94107 9418851301</p>
	<p>PEDANA PARAURTI S.M.C. - GRIGIO BUMPER FOOTSTEP S.M.C. - GREY COS.PEL. ref. SIMILAR ref. 405.94108 9418800225</p>







ActrosMP1/MegaSpaceMP1

	<p>PORTA TARGA S.M.C. - GRIGIO PLATE SUPPORT S.M.C. - GREY</p> <p>COS.PEL. ref. SIMILAR ref. 405.94109 9418800325</p>
	<p>VETRO SPECCHIO RISCALDATO - (440x193mm) MIRROR GLASS HEATED - (440x193mm)</p> <p>COS.PEL. ref. SIMILAR ref. 505.12033 0018112033</p> <p style="text-align: right;">DX-SX RH-LH</p>
	<p>SPECCHIO GUARDARUOTA MANUALE ROOF MIRROR MANUAL</p> <p>COS.PEL. ref. SIMILAR ref. 505.12231 0028106016</p>
	<p>SPECCHIO GUARDARUOTA MANUALE ROOF MIRROR MANUAL</p> <p>COS.PEL. ref. SIMILAR ref. 505.12232 0028100816</p> <p style="text-align: right;">DX RH</p>
	<p>VETRO SPECCHIO GUARDARUOTA (310x170mm) ROOF MIRROR GLASS (310x170mm)</p> <p>COS.PEL. ref. SIMILAR ref. 505.12233 0018112233</p> <p style="text-align: right;">DX-SX RH-LH</p>
	<p>SPECCHIO GUARDARUOTA MANUALE ROOF MIRROR MANUAL</p> <p>COS.PEL. ref. SIMILAR ref. 505.94327 9418102116 / A9418101016</p> <p style="text-align: right;">Modelli dal 10/2004 - Models from 10/2004 on</p>
	<p>VISIERA 1a serie MEGA SPACE SENZA STAFFE SUN VISOR 1st series MEGA SPACE WITHOUT BRACKET KIT</p> <p>COS.PEL. ref. SIMILAR ref. 705.94120 9418100010</p> <p style="text-align: right;">Relativo kit staffe 1005.94120</p>
	<p>VISIERA 1a serie TETTO BASSO TETTO BASSO - SENZA STAFFE SUN VISOR 1st series LOW CAB LOW CAB - WITHOUT BRACKET KIT</p> <p>COS.PEL. ref. SIMILAR ref. 705.94121 9418110010 / 9418110610</p> <p style="text-align: right;">Relativo kit staffe 1005.94121</p>

ActrosMP1/MegaSpaceMP1

	<p>CONVOGLIATORE ARIA S.M.C. - BIANCO AIR CONVEYOR S.M.C. - WHITE COS.PEL. ref. SIMILAR ref. 905.84122 9418840322 DX RH</p> <p>905.84123 9418840222 SX LH</p>
	<p>CONVOGLIATORE ARIA A.B.S. - NERO AIR CONVEYOR A.B.S. - BLACK COS.PEL. ref. SIMILAR ref. 905.84124 9418840522 DX RH</p> <p>905.84125 9418840422 SX LH</p>
	<p>CONVOGLIATORE ARIA A.B.S. - BIANCO AIR CONVEYOR A.B.S. - WHITE COS.PEL. ref. SIMILAR ref. 905.84126 9418841522 DX RH</p> <p>905.84127 9418841422 SX LH</p>
	<p>CONVOGLIATORE ARIA A.B.S. - BIANCO AIR CONVEYOR A.B.S. - WHITE COS.PEL. ref. SIMILAR ref. 905.84128 9418841222 DX RH</p> <p>905.84129 9418841122 SX LH</p>
	<p>CONVOGLIATORE ARIA A.B.S. - NERO - CABINA CORTA AIR CONVEYOR A.B.S. - BLACK - LOW CAB COS.PEL. ref. SIMILAR ref. 905.94160 9418800444 DX RH</p> <p>905.94161 9418800344 SX LH</p>
	<p>CONVOGLIATORE ARIA A.B.S. - NERO - CABINA CORTA AIR CONVEYOR A.B.S. - BLACK - LOW CAB COS.PEL. ref. SIMILAR ref. 905.94162 - DX RH</p> <p>905.94163 - SX LH</p>
	<p>CONVOGLIATORE ARIA A.B.S. - GRIGIO - MEGA SPACE AIR CONVEYOR A.B.S. - GREY - MEGA SPACE COS.PEL. ref. SIMILAR ref. 905.94164 9418840722 DX RH</p> <p>905.94165 9418840622 SX LH</p>
	<p>COPRI BATTERIE S.M.C. - GRIGIO BATTERY COVER S.M.C. - GREY COS.PEL. ref. SIMILAR ref. 1005.00002 9415410103</p>







ActrosMP1/MegaSpaceMP1

	<p>GRIGLIA PEDANA INFERIORE LOWER FOOTSTEP GRILLE</p> <p>COS.PEL. ref. SIMILAR ref. 1005.94300 9416663428</p> <p style="text-align: right;">DX-SX RH-LH</p> <p style="text-align: center;">Relativa pedana: 305.94104/5</p>
	<p>GRIGLIA PEDANA INFERIORE LOWER FOOTSTEP GRILLE</p> <p>COS.PEL. ref. SIMILAR ref. 1005.94302 9416663828</p> <p style="text-align: right;">DX RH</p> <p>1005.94303 9416663728</p> <p style="text-align: right;">SX LH</p>
	<p>GRIGLIA PEDANA SUPERIORE UPPER FOOTSTEP GRILLE</p> <p>COS.PEL. ref. SIMILAR ref. 1005.94304 9416663528</p> <p style="text-align: right;">DX-SX RH-LH</p>
	<p>GRIGLIA PEDANA SUPERIORE UPPER FOOTSTEP GRILLE</p> <p>COS.PEL. ref. SIMILAR ref. 1005.94305 9416663328</p> <p style="text-align: right;">DX-SX RH-LH</p> <p style="text-align: center;">Relativa pedana: 305.94104/5</p>
<p>AD ESAURIMENTO SCORTE <small>UNTIL STOCK-OUT</small></p> 	<p>RIVESTIMENTO PORTA DOOR INNER PANEL</p> <p>COS.PEL. ref. SIMILAR ref. 1405.94101 A9417200570</p> <p style="text-align: right;">SX LH</p>
	<p>FANALE LATERALE LED 6 LED - 12 / 24 Volt SIDE LAMP LED 6 LED - 12 / 24 Volt</p> <p>COS.PEL. ref. SIMILAR ref. 003007 A0005445411</p> <p style="text-align: right;">DX-SX RH-LH</p> <p style="text-align: center;">ARANCIO / ORANGE (12/24 V)</p>
	<p>FANALINO LATERALE P21 5W - FORNITO SENZA PORTALAMPADA CORNER LAMP P21 5W - WITHOUT SOCKET</p> <p>COS.PEL. ref. SIMILAR ref. 1605.94162 A9418200921</p> <p style="text-align: right;">DX RH</p> <p>1605.94163 A9418200521</p> <p style="text-align: right;">SX LH</p>
	<p>FANALINO LATERALE P21W CORNER LAMP P21W</p> <p>COS.PEL. ref. SIMILAR ref. 1605.94166 9418201321</p> <p style="text-align: right;">DX-SX RH-LH</p>

ActrosMP1/MegaSpaceMP1



 	<p>PROIETTORE H1 H4 - CORRETTORE ASSETTO MANUALE HEADLAMP H1 H4 - MANUAL LOAD LEVEL ADJUSTEMENT COS.PEL. ref. SIMILAR ref. 1605.94160 9418202661 / 9418205261 DX RH</p> <p>1605.94161 9418202561 / 9418205161 SX LH</p>
 	<p>PROIETTORE P21W - H4 - W5W - CORRETTORE ASSETTO MANUALE HEADLAMP P21W - H4 - W5W - MANUAL LOAD LEVEL ADJUSTEMENT COS.PEL. ref. SIMILAR ref. 1605.94164 0301081114 / 9418205461 DX RH</p> <p>1605.94165 0301081119 / 9418205361 SX LH</p>
<p>AD ESAURIMENTO SCORTE UNTR. SFL-OUT</p>  	<p>PROIETTORE H3 HEADLAMP H3 COS.PEL. ref. SIMILAR ref. 1605.94168 A0028208556 DX RH</p> <p>1605.94167 A0028208456 SX LH</p>
 	<p>FENDINEBBIA H3 FOG LAMP H3 COS.PEL. ref. SIMILAR ref. 1605.94170 A0028208756 DX RH</p> <p>1605.94169 A0028208656 SX LH</p>
	<p>MANIGLIA PORTA CON CHIAVE DOOR HANDLE WITH KEY COS.PEL. ref. SIMILAR ref. 1705.94100 A9417600559 DX RH</p> <p>1705.94101 A9417600459 SX LH</p>
	<p>TIRANTE PARAFANGO POSTERIORE GOMMA - NERO MUDGUARD TENSIONER 1st SERIES RUBBER - BLACK COS.PEL. ref. SIMILAR ref. 1001.23641 9415220067 / 9445220167</p>
	<p>TIRANTE PARAFANGO GOMMA - NERO MUDGUARD TENSIONER RUBBER - BLACK COS.PEL. ref. SIMILAR ref. 1005.00003 9415220167</p>
	<p>MOLLA A GAS Lunghezza [mm] 609 Corsa [mm] 262 Forza scarto [N] 360 GAS SPRING Lenght [mm] 609 Stroke [mm] 262 Waste force [N] 360 COS.PEL. ref. SIMILAR ref. 2405.94100 A0019808464</p>

ActrosMP1/MegaSpaceMP1

	<p>DEFLETTORI LATERALI CON CLIPS SIDEWINDOW DEFLECTORS WITH CLIPS</p> <p>COS.PEL. ref. SIMILAR ref. 3005.00003 -</p>
	<p>PROTEZIONE FARO Per Cos.Me GRID For Cos.Me</p> <p>COS.PEL. ref. SIMILAR ref. 2000.00014 -</p>
	<p>KIT PER CONNESSIONI ELETTRICHE Connettore SUPERSEAL 2 vie femmina KIT FOR ELECTRICAL JOINTS Connector SUPERSEAL ways female</p> <p>COS.PEL. ref. SIMILAR ref. 003123 -</p> <p>Connettore per la serie 1500.xxxxx</p>
	<p>FANALE POSTERIORE 7 FUNZIONI REAR-LIGHT 7 FUNCTIONS</p> <p>COS.PEL. ref. SIMILAR ref. 005550 A0015406370 DX RH Relativo connettore 003120 005560 A0015406270 SX LH Con luce targa / With plate light - conn. 003120</p> <p>TRASPARENTE / LENS 011171 A0025440790 DX RH 011181 A0025441290 SX LH</p>
 <p>AD ESAURIMENTO SCORTE ON THE SELL OUT</p>	<p>FANALE POSTERIORE LED REAR-LIGHT LED</p> <p>COS.PEL. ref. SIMILAR ref. 005562 - DX RH Relativo connettore 003120 005561 - SX LH Con luce targa / With plate ligh - conn. 003120</p> <p>TRASPARENTE / LENS 011113 - DX-SX RH-LH</p>
	<p>FANALE POSTERIORE RIMORCHIO REAR-LIGHT TRAILER</p> <p>COS.PEL. ref. SIMILAR ref. 005590 - DX RH 005600 - SX LH Con luce targa / With plate light</p> <p>TRASPARENTE / LENS 011191 - DX RH 011201 - SX LH</p>
	<p>FANALE POSTERIORE LED - 24V - CONNETTORE POSTERIORE AMP 1.5 REAR-LIGHT LED - 24V - REAR CONNECTOR AMP 1.5</p> <p>COS.PEL. ref. SIMILAR ref. 1500.00000 - DX RH Relativo connettore multipolare 003120 1500.00001 - SX LH Relativo connettore multipolare 003120</p> <p>TRASPARENTE / LENS</p>

ActrosMP2/MegaSpaceMP2

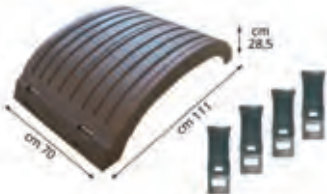

	<p>FRONTALE SUPERIORE S.M.C. - GRIGIO UPPER GRILLE S.M.C. - GREY</p> <p>COS.PEL. ref. SIMILAR ref. 105.94300 9437500009</p>
	<p>GRIGLIA FRONTALE MEGA SPACE FRONT GRILLE</p> <p>COS.PEL. ref. SIMILAR ref. 105.94302 9437500518</p>
	<p>PARAFANGO POSTERIORE FRONT MUDGUARD - REAR</p> <p>COS.PEL. ref. SIMILAR ref. 205.94310 9438800406 DX RH 205.94311 9438800306 SX LH</p>
	<p>RIPARO ANTISPRAY MUDGUARD INNER</p> <p>COS.PEL. ref. SIMILAR ref. 205.94312 - DX-SX RH-LH</p> <p>Per/For : 205.20013</p>
	<p>CALOTTA PARAF. POSTERIORE BASSA CON 4 TIRANTI 2a serie - P.P.T. - GRIGIO REAR MUDGUARD LOW CAB WITH 4 MUDGUARD TENS. 2nd series - P.P.T. - GREY</p> <p>COS.PEL. ref. SIMILAR ref. 205.20006 9305200007 / 9415220167 DX-SX RH-LH (205.20007 versione senza i tiranti)</p>

ActrosMP2/MegaSpaceMP2

	<p>CALOTTA PARAFANGO POSTERIORE BASSA 2a serie - P.P.T. - GRIGIO REAR MUDGUARD LOW CAB 2nd series - P.P.T. - GREY</p> <p>COS.PEL. ref. SIMILAR ref. 205.20007 9305200007 DX-SX RH-LH</p> <p>Relativo tirante 1005.00003 - (205.20006 versione con i tiranti)</p>
	<p>CALOTTA PARAFANGO POSTERIORE ALTA 3a serie - P.P.T. - GRIGIO REAR MUDGUARD HIGH CAB 3rd series - P.P.T. - GREY</p> <p>COS.PEL. ref. SIMILAR ref. 205.20008 9305200207 DX-SX RH-LH</p> <p>Relativo tirante 1005.00003 - (205.20009 versione con i tiranti)</p>
	<p>CALOTTA PARAF. POSTERIORE ALTA CON 4 TIRANTI 3a serie - P.P.T. - GRIGIO REAR MUDGUARD HIGH CAB WITH 4 TENSIONERS 3rd series - P.P.T. - GREY</p> <p>COS.PEL. ref. SIMILAR ref. 205.20009 9305200207 DX-SX RH-LH</p> <p>(205.20008 versione senza i tiranti)</p>
	<p>MEZZO PARAFANGO POSTERIORE PARTE ANT. CON STAFFE - 2a/3a Serie REAR MUDGUARD FRONT PART WITH BRACKETS - 2nd/3th Series</p> <p>COS.PEL. ref. SIMILAR ref. 205.20010 9305200119 DX RH</p> <p>205.20011 9305200019 SX LH</p>
	<p>CALOTTA PARAFANGO POSTERIORE REAR MUDGUARD</p> <p>COS.PEL. ref. SIMILAR ref. 205.20012 9305200107 DX-SX RH-LH</p> <p>Relativo tirante 1005.00003 - (205.20015 versione con i tiranti)</p>
	<p>MEZZO PARAFANGO POSTERIORE 2a/3a Serie CON STAFFE - SENZA RIPARO ANTISPRAY REAR HALF MUDGUARD 2nd/3th Series WITH BRACKETS W/O COVER ANTISPRAY</p> <p>COS.PEL. ref. SIMILAR ref. 205.20013 9305200020 DX-SX RH-LH</p> <p>Relativo riparo antispray : 205.94312</p>
	<p>MEZZO PARAFANGO POSTERIORE 2a/3a serie CON STAFFE - CON RIPARO ANTISPRAY 205.94312 REAR HALF MUDGUARD 2nd/3th SERIES WITH BRACKETS - WITH COVER ANTISPRAY 205.94312</p> <p>COS.PEL. ref. SIMILAR ref. 205.20014 9305200120 / 9305200820 DX-SX RH-LH</p>
	<p>CALOTTA PARAF. POSTERIORE CON 4 TIRANTI REAR MUDGUARD WITH 4 TENSIONERS</p> <p>COS.PEL. ref. SIMILAR ref. 205.20015 9305200107 DX-SX RH-LH</p> <p>(205.20012 versione senza i tiranti)</p>

ActrosMP2/MegaSpaceMP2

	<p>PEDANA PARAFANGO S.M.C. - GRIGIO MUDGUARD FOOTSTEP S.M.C. - GREY COS.PEL. ref. SIMILAR ref. 305.94104 9416662001 / 9436663901 DX RH</p> <p>305.94105 Griglia/Grille : 1005.94300 inf - 1005.94305 sup 9416661901 / 9436663801 SX LH</p> <p>Griglia/Grille : 1005.94300 inf - 1005.94305 sup</p>
	<p>MODANATURA WIDE MOULDING, STAND PANEL MUDGUARD COS.PEL. ref. SIMILAR ref. 305.94338 9436660737 DX RH</p> <p>305.94339 9436660637 SX LH</p>
	<p>PROFILO PEDANA S.M.C. - GRIGIO EDGE FOOTSTEP S.M.C. - GREY COS.PEL. ref. SIMILAR ref. 305.94342 A9436660937-7354 DX RH</p> <p>305.94343 A9436660837-7354 SX LH</p>
	<p>PEDANA S.M.C. - GRIGIO FOOTSTEP S.M.C. - GREY COS.PEL. ref. SIMILAR ref. 305.94344 9436600701 DX RH</p> <p>305.94345 Griglia/Grille : 1005.94301 9436600601 SX LH</p> <p>Griglia/Grille : 1005.94301</p>
	<p>PEDANA S.M.C. - GRIGIO FOOTSTEP S.M.C. - GREY COS.PEL. ref. SIMILAR ref. 305.94340 9436601101 / A9436600401-7354 DX RH</p> <p>305.94341 Griglia/Grille: 1005.94301 inf - 1005.94301 sup 9436601001 / A9436600301-7354 SX LH</p> <p>Griglia/Grille: 1005.94301 inf - 1005.94301 sup</p>
	<p>PEDANA INFERIORE BASSA FOOTSTEP LOW VERSION COS.PEL. ref. SIMILAR ref. 305.94348 9436600901 DX RH</p> <p>305.94349 Griglia/Grille : 1005.94301 9436600801 SX LH</p> <p>Relativa griglia : 1005.94301</p>
	<p>TAPPO PEDANA STAND PANEL COVER COS.PEL. ref. SIMILAR ref. 305.94352 9436660005 DX-SX RH-LH</p>
	<p>PEDANA TIPO BASSO FOOT STEP BRACKET SHORT COS.PEL. ref. SIMILAR ref. 305.94353 9436600228 DX-SX RH-LH</p>

ActrosMP2/MegaSpaceMP2

	<p>PEDANA TIPO ALTO FOOT STEP BRACKET LONG</p> <p>COS.PEL. ref. SIMILAR ref. 305.94354 9436600128</p> <p style="text-align: right;">DX-SX RH-LH</p>
	<p>ANGOLO PARAURTI S.M.C. - GRIGIO - SENZA FORO FENDI CORNER BUMPER S.M.C. - GREY - W/O HOLE</p> <p>COS.PEL. ref. SIMILAR ref. 405.94358 9438800370 / 9438809972</p> <p style="text-align: right;">DX RH</p> <p>405.94359 9438800270 / 9438809872</p> <p style="text-align: right;">SX LH</p>
	<p>ANGOLO PARAURTI S.M.C. - GRIGIO - CON FORO FENDI CORNER BUMPER S.M.C. - GREY - WITH HOLE</p> <p>COS.PEL. ref. SIMILAR ref. 405.94360 9438800173 / A9438800770-7354</p> <p style="text-align: right;">DX RH</p> <p>405.94361 9438800073 / A9438800670-7354</p> <p style="text-align: right;">SX LH</p>
	<p>PARAURTI CENTRALE SUPERIORE S.M.C. - GRIGIO UPPER CENTRE BUMPER S.M.C. - GREY</p> <p>COS.PEL. ref. SIMILAR ref. 405.94362 A9438850201-7354</p>
	<p>PARAURTI CENTRALE INFERIORE S.M.C. - GRIGIO BUMPER LOWER CENTRAL PART S.M.C. - GREY</p> <p>COS.PEL. ref. SIMILAR ref. 405.94363 A9438850226 / A9438850426-7354</p>
	<p>ANGOLO PARAURTI MEGA SPACE S.M.C. - GRIGIO CORNER BUMPER MEGA SPACE S.M.C. - GREY</p> <p>COS.PEL. ref. SIMILAR ref. 405.94368 9438804373 / 9438807470 / 9438809870</p> <p style="text-align: right;">DX RH</p> <p>405.94369 9438807570</p> <p style="text-align: right;">SX LH</p>
	<p>PARAURTI CENTRALE MEGA SPACE S.M.C. - GRIGIO CENTRAL BUMPER MEGA SPACE S.M.C. - GREY</p> <p>COS.PEL. ref. SIMILAR ref. 405.94370 9438850301</p>
	<p>ANGOLO PARAURTI CON PRESA ARIA E FORO FENDI S.M.C. - GRIGIO - PIU' FORI CORNICE CORNER BUMPER W/HOLE S.M.C. - GREY</p> <p>COS.PEL. ref. SIMILAR ref. 405.94376 9438800104 / 9438804573 / 9438807270</p> <p style="text-align: right;">DX RH</p> <p>405.94377 9438800004 / 9438804473 / 9438807370</p> <p style="text-align: right;">SX LH</p>

ActrosMP2/MegaSpaceMP2

	<p>ANGOLO SOTTOPARAURTI P.P. - GRIGIO CORNER SPOILER P.P. - GREY COS.PEL. ref. SIMILAR ref. 405.94366 9438850425 DX RH</p> <p>405.94365 9438850325 SX LH</p>
	<p>SOTTOPARAURTI CENTRALE P.P. - GRIGIO CENTRAL SPOILER P.P. - GREY COS.PEL. ref. SIMILAR ref. 405.94367 9438850525</p>
	<p>ANGOLO SOTTOPARAURTI A.B.S. - NERO CORNER SPOILER A.B.S. - BLACK COS.PEL. ref. SIMILAR ref. 405.94372 9438840174 DX RH</p> <p>405.94371 9438840074 SX LH</p>
	<p>SOTTOPARAURTI CENTRALE P.P. - NERO CENTRAL SPOILER P.P. - BLACK COS.PEL. ref. SIMILAR ref. 405.94373 9438850374</p>
	<p>TERMINALE PARAURTI A.B.S. TERMINAL BUMPER A.B.S. COS.PEL. ref. SIMILAR ref. 405.94374 9438850522 DX RH</p> <p>405.94375 9438850422 SX LH</p>
	<p>TAPPO PARAURTI FRONT BUMPER CAP COS.PEL. ref. SIMILAR ref. 405.94398 9438850174 DX RH</p> <p>405.94397 9438850074 SX LH</p>
	<p>SPECCHIO RETROVISORE MANUALE REAR-VIEW MIRROR MANUAL COS.PEL. ref. SIMILAR ref. 505.12100 - DX RH</p> <p>505.12101 - SX LH</p>
	<p>SPECCHIO RETROVISORE ELETTRICO REAR-VIEW MIRROR ELECTRIC COS.PEL. ref. SIMILAR ref. 505.12102 - DX RH</p> <p>505.12103 - SX LH</p>

ActrosMP2/MegaSpaceMP2

	<p>SPECCHIO FRONTALE CON BRACCIO 24V FRONT VISION MIRROR WITH ARM 24V</p> <p>COS.PEL. ref. SIMILAR ref. 505.12104 9438104716</p> <p style="text-align: right;">DX RH</p>
	<p>SPECCHIO RETROVISORE MANUALE REAR-VIEW MIRROR MANUAL</p> <p>COS.PEL. ref. SIMILAR ref. 505.12106 0008109016</p> <p style="text-align: right;">DX-SX RH-LH</p>
	<p>SPECCHIO RETROVISORE ELETTRICO - RISCALDATO REAR-VIEW MIRROR ELECTRIC - HEATED</p> <p>COS.PEL. ref. SIMILAR ref. 505.12107 0018109116</p> <p style="text-align: right;">DX-SX RH-LH</p>
	<p>VETRO SPECCHIO RISCALDATO MIRROR GLASS HEATED</p> <p>COS.PEL. ref. SIMILAR ref. 505.12108 0028110433</p> <p style="text-align: right;">DX-SX RH-LH</p>
	<p>SPECCHIO RETROVISORE GRANDANGOLO REAR-VIEW MIRROR WIDE ANGLE</p> <p>COS.PEL. ref. SIMILAR ref. 505.12109 0018109216</p> <p style="text-align: right;">DX-SX RH-LH</p>
	<p>VETRO SPECCHIO GRANDANGOLO MIRROR GLASS WIDE ANGLE</p> <p>COS.PEL. ref. SIMILAR ref. 505.12110 0018116033</p> <p style="text-align: right;">DX-SX RH-LH</p>
	<p>SPECCHIO FRONTALE CON BRACCIO 24V FRONT MIRROR WITH ARM 24V</p> <p>COS.PEL. ref. SIMILAR ref. 505.94325 9438105116</p>
	<p>SPECCHIO GUARDARUOTA MANUALE ROOF MIRROR MANUAL</p> <p>COS.PEL. ref. SIMILAR ref. 505.94327 9418102116 / A9418101016</p> <p style="text-align: right;">Modelli dal 10/2004 - Models from 10/2004 on</p>



ActrosMP2/MegaSpaceMP2

 <p>cm 234 cm 27</p>	<p>VISIERA MP2 MEGA SPACE CON SPECCHIO FRONTALE MEGA SPACE MP2 SUN VISOR WITH FRONT MIRROR</p> <p>COS.PEL. ref. 705.94308 SIMILAR ref. 9438111010</p>
 <p>cm 234 cm 27</p>	<p>VISIERA MP2 MEGA SPACE SENZA SPECCHIO FRONTALE MEGA SPACE MP2 SUN VISOR WITHOUT FRONT MIRROR</p> <p>COS.PEL. ref. 705.94309 SIMILAR ref. 9438110010</p> <p>Relativo kit staffe 1005.94309</p>
 <p>cm 234,5 cm 25,5 cm 65,5 cm 65,5</p>	<p>VISIERA CON SPECCHIO FRONTALE TETTO BASSO SUN VISOR WITH FRONT MIRROR LOW CAB</p> <p>COS.PEL. ref. 705.94310 SIMILAR ref. 9438111210</p> <p>Relativo kit staffe 1005.94311</p>
 <p>cm 235 cm 25,5 cm 65 cm 65</p>	<p>VISIERA SENZA SPECCHIO FRONTALE TETTO BASSO SUN VISOR W/O FRONT MIRROR LOW CAB</p> <p>COS.PEL. ref. 705.94311 SIMILAR ref. 9438110210</p> <p>Relativo kit staffe 1005.94311</p>
	<p>CONVOGLIATORE ARIA A.B.S. AIR CONVEYOR A.B.S.</p> <p>COS.PEL. ref. 905.94370 SIMILAR ref. 9438840123 DX RH</p> <p>905.94371 9438840023 SX LH</p>
	<p>CONVOGLIATORE ARIA P.P. AIR CONVEYOR P.P.</p> <p>COS.PEL. ref. 905.94372 SIMILAR ref. 9438840323 DX RH</p> <p>905.94373 9438840223 SX LH</p>
	<p>CONVOGLIATORE ARIA A.B.S. AIR CONVEYOR A.B.S.</p> <p>COS.PEL. ref. 905.94374 SIMILAR ref. 9438840723 DX RH</p> <p>905.94375 9438840623 SX LH</p>
	<p>GRIGLIA PEDANA PICCOLA INFERIORE SMALL FOOTSTEP GRILLE</p> <p>COS.PEL. ref. 1005.94301 SIMILAR ref. 9436660028 DX-SX RH-LH</p>

ActrosMP2/MegaSpaceMP2

	<p>SUPPORTO PARAFANGO FRONT MUDGUARD BRACKET</p> <p>COS.PEL. ref. SIMILAR ref. 1005.94306 9438810011</p> <p style="text-align: right;">DX-SX RH-LH</p>
	<p>SUPPORTO PEDANA FOOTSTEP SUPPORT</p> <p>COS.PEL. ref. SIMILAR ref. 1005.94308 9436661031</p> <p style="text-align: right;">DX RH</p> <p>1005.94307 9436660931</p> <p style="text-align: right;">SX LH</p>
	<p>SUPPORTO PEDANA FRONT BUMPER BRACKET</p> <p>COS.PEL. ref. SIMILAR ref. 1005.94312 9436660578</p> <p style="text-align: right;">DX RH</p> <p>1005.94313 9436660478</p> <p style="text-align: right;">SX LH</p>
	<p>SUPPORTO PEDANA FRONT BUMPER BRACKET</p> <p>COS.PEL. ref. SIMILAR ref. 1005.94314 9436660778</p> <p style="text-align: right;">DX RH</p> <p>1005.94315 9436660678</p> <p style="text-align: right;">SX LH</p>
	<p>SUPPORTO PEDANA FRONT BUMPER BRACKET</p> <p>COS.PEL. ref. SIMILAR ref. 1005.94316 9436660278</p> <p style="text-align: right;">DX RH</p> <p>1005.94317 9436660178</p> <p style="text-align: right;">SX LH</p>
	<p>SUPPORTO PEDANA FRONT BUMPER BRACKET</p> <p>COS.PEL. ref. SIMILAR ref. 1005.94318 9438853514</p> <p style="text-align: right;">DX RH</p> <p>1005.94319 9438853414</p> <p style="text-align: right;">SX LH</p>
	<p>FANALINO LUCE DIURNA LED CORNER LAMP LED</p> <p>COS.PEL. ref. SIMILAR ref. 1605.94372 A9438200856</p> <p style="text-align: right;">DX RH</p> <p>1605.94373 A9438200756</p> <p style="text-align: right;">SX LH</p>
	<p>PROIETTORE XENON SENZA CENTRALINA HEADLAMP XENON WITHOUT CONTROL UNIT</p> <p>COS.PEL. ref. SIMILAR ref. 1605.94354 9438202361</p> <p style="text-align: right;">DX RH</p> <p>1605.94355 9438202261</p> <p style="text-align: right;">SX LH</p>

ActrosMP2/MegaSpaceMP2



	<p>PROIETTORE H1 H7 - PREDISPOSTO PER CORRETTORE ASSETTO HEADLAMP H1 H7 - SUITABLE FOR LOAD LEVEL ADJUSTEMENT COS.PEL. ref. SIMILAR ref. 1605.94358 9438200461 DX RH</p> <p>1605.94359 9438200361 SX LH</p>
	<p>PROIETTORE H1 H7 - CORRETTORE ASSETTO MANUALE HEADLAMP H1 H7 - MANUAL LOAD LEVEL ADJUSTEMENT COS.PEL. ref. SIMILAR ref. 1605.94360 9438200261 DX RH</p> <p>1605.94361 9438200161 SX LH</p>
	<p>FENDINEBBIA H3 FOG LAMP H3 COS.PEL. ref. SIMILAR ref. 1605.94362 9438200156 DX RH</p> <p>1605.94363 9438200056 SX LH</p>
	<p>CORNICE FARO HEADLAMP FRAME COS.PEL. ref. SIMILAR ref. 1605.94370 9438260359 DX RH</p> <p>1605.94371 9438260259 SX LH</p>
	<p>TIRANTE PORTA DOOR STOP COS.PEL. ref. SIMILAR ref. 1705.94350 9417230120 DX-SX RH-LH</p>
	<p>CERNIERA SUPERIORE PORTA HOOD HINGE UPPER COS.PEL. ref. SIMILAR ref. 1705.94352 9417200837 DX RH</p> <p>1705.94351 9417200037 SX LH</p>
	<p>VASCHETTA ESPANSIONE EXPANSION TANK COS.PEL. ref. SIMILAR ref. 2105.94180 9100002004 / A0005003149</p>
<p>AD ESAURIMENTO SCORTE UNTIL SPILL-OUT</p> 	<p>VASCHETTA ESPANSIONE EXPANSION TANK COS.PEL. ref. SIMILAR ref. 2105.94181 A0005003049 / A0005003449 / A0005003849</p>

ActrosMP2/MegaSpaceMP2

	<p>MOLLA A GAS Lunghezza [mm] 609 Corsa [mm] 262 Forza scarto [N] 360 GAS SPRING Lenght [mm] 609 Stroke [mm] 262 Waste force [N] 360</p> <p>COS.PEL. ref. SIMILAR ref. 2405.94100 A0019808464</p>
	<p>DEFLETTORI LATERALI CON CLIPS SIDEWINDOW DEFLECTORS WITH CLIPS</p> <p>COS.PEL. ref. SIMILAR ref. 3005.00001 -</p>
	<p>KIT PER CONNESSIONI ELETTRICHE Connettore SUPERSEAL 2 vie femmina KIT FOR ELECTRICAL JOINTS Connector SUPERSEAL ways female</p> <p>COS.PEL. ref. SIMILAR ref. 003123 -</p> <p>Connettore per la serie 1500.xxxxx</p>
 <p style="text-align: center;">15,2 cm</p>	<p>FANALE POSTERIORE REAR-LIGHT</p> <p>LED - 24V - CONNETTORE POSTERIORE AMP 1.5 LED - 24V - REAR CONNECTOR AMP 1.5</p> <p>COS.PEL. ref. SIMILAR ref. 1500.00000 - 1500.00001 -</p> <p>Relativo connettore multipolare 003120 Relativo connettore multipolare 003120</p> <p>TRASPARENTE / LENS</p> <p style="text-align: right;">DX RH SX LH</p>

ActrosMP3/MegaSpaceMP3



	<p>GRIGLIA CENTRALE CENTRAL GRILLE</p> <p>COS.PEL. ref. SIMILAR ref. 105.94303 9437501518</p>
	<p>GRIGLIA CENTRALE CENTRE GRILLE</p> <p>COS.PEL. ref. SIMILAR ref. 105.94304 9437501418</p>
	<p>RIPARO ANTISPRAY MUDGUARD INNER</p> <p>COS.PEL. ref. SIMILAR ref. 205.94312 -</p> <p style="text-align: right;">DX-SX RH-LH</p> <p style="text-align: right;">Per/For : 205.20013</p>
	<p>CALOTTA PARAFANGO POSTERIORE ALTA 3a serie - P.P.T. - GRIGIO REAR MUDGUARD HIGH CAB 3rd series - P.P.T. - GREY</p> <p>COS.PEL. ref. SIMILAR ref. 205.20008 9305200207</p> <p style="text-align: right;">DX-SX RH-LH</p> <p style="text-align: right;">Relativo tirante 1005.00003 - (205.20009 versione con i tiranti)</p>
	<p>CALOTTA PARAF. POSTERIORE ALTA CON 4 TIRANTI 3a serie - P.P.T. - GRIGIO REAR MUDGUARD HIGH CAB WITH 4 TENSIONERS 3rd series - P.P.T. - GREY</p> <p>COS.PEL. ref. SIMILAR ref. 205.20009 9305200207</p> <p style="text-align: right;">DX-SX RH-LH</p> <p style="text-align: right;">(205.20008 versione senza i tiranti)</p>

ActrosMP3/MegaSpaceMP3

	<p>MEZZO PARAFANGO POSTERIORE PARTE ANT. CON STAFFE - 2a/3a Serie REAR MUDGUARD FRONT PART WITH BRACKETS - 2nd/3th Series COS.PEL. ref. SIMILAR ref. 205.20010 9305200119 DX RH</p> <p>205.20011 9305200019 SX LH</p>
	<p>CALOTTA PARAFANGO POSTERIORE REAR MUDGUARD</p> <p>COS.PEL. ref. SIMILAR ref. 205.20012 9305200107 DX-SX RH-LH</p> <p>Relativo tirante 1005.00003 - (205.20015 versione con i tiranti)</p>
	<p>MEZZO PARAFANGO POSTERIORE 2a/3a Serie CON STAFFE - SENZA RIPARO ANTISPRAY REAR HALF MUDGUARD 2nd/3th Series WITH BRACKETS W/O COVER ANTISPRAY</p> <p>COS.PEL. ref. SIMILAR ref. 205.20013 9305200020 DX-SX RH-LH</p> <p>Relativo riparo antispray : 205.94312</p>
	<p>MEZZO PARAFANGO POSTERIORE 2a/3a serie CON STAFFE - CON RIPARO ANTISPRAY 205.94312 REAR HALF MUDGUARD 2nd/3th SERIES WITH BRACKETS - WITH COVER ANTISPRAY 205.94312</p> <p>COS.PEL. ref. SIMILAR ref. 205.20014 9305200120 / 9305200820 DX-SX RH-LH</p>
	<p>CALOTTA PARAF. POSTERIORE CON 4 TIRANTI REAR MUDGUARD WITH 4 TENSIONERS</p> <p>COS.PEL. ref. SIMILAR ref. 205.20015 9305200107 DX-SX RH-LH</p> <p>(205.20012 versione senza i tiranti)</p>
	<p>PEDANA PARAFANGO S.M.C. - GRIGIO MUDGUARD FOOTSTEP S.M.C. - GREY COS.PEL. ref. SIMILAR ref. 305.94104 9416662001 / 9436663901 DX RH</p> <p>305.94105 Griglia/Grille : 1005.94300 inf - 1005.94305 sup 9416661901 / 9436663801 SX LH</p> <p>Griglia/Grille : 1005.94300 inf - 1005.94305 sup</p>
	<p>PEDANA S.M.C. - GRIGIO FOOTSTEP S.M.C. - GREY COS.PEL. ref. SIMILAR ref. 305.94344 9436600701 DX RH</p> <p>305.94345 Griglia/Grille : 1005.94301 9436600601 SX LH</p> <p>Griglia/Grille : 1005.94301</p>
	<p>PEDANA MEGA SPACE - S.M.C. - GRIGIO FOOTSTEP MEGA SPACE - S.M.C. - GREY COS.PEL. ref. SIMILAR ref. 305.94106 9416662201 / 9436660501 / DX RH 9436664301</p> <p>305.94107 Griglia/Grille: 1005.94302 inf - 1005.94304 sup 9416662101 / 9436660401 / SX LH 9436664201</p> <p>Griglia/Grille: 1005.94303 inf - 1005.94304 sup</p>

ALL ITEMS MENTIONED IN OUR CATALOGUE ARE NOT ORIGINAL PARTS BUT PERFECTLY INTERCHANGEABLE WITH THEM.

GOVERNING LEGISLATIONS FOR THE SALE OF OUR PRODUCTS DIFFER IN EACH COUNTRY.

INFRINGEMENTS, IF ANY, OF LOCAL LEGISLATIONS ARE RESPONSIBILITY OF THE RETAILER IN THE COUNTRY OF FINAL DISTRIBUTION.



ActrosMP3/MegaSpaceMP3

 <p>cm 20</p>	<p>PEDANA INFERIORE BASSA FOOTSTEP LOW VERSION</p> <p>COS.PEL. ref. 305.94348 SIMILAR ref. 9436600901 DX RH</p> <p>305.94349 Griglia/Grille : 1005.94301 9436600801 SX LH</p> <p>Relativa griglia : 1005.94301</p>
 <p>cm 39,5</p>	<p>PEDANA FOOTSTEP</p> <p>COS.PEL. ref. 305.94350 SIMILAR ref. 9436660901 DX RH</p> <p>305.94351 Griglia/grille : 1005.94304 9436660801 SX LH</p> <p>Griglia/grille : 1005.94304</p>
	<p>TAPPO PEDANA STAND PANEL COVER</p> <p>COS.PEL. ref. 305.94352 SIMILAR ref. 9436660005 DX-SX RH-LH</p>
 <p>cm 62</p>	<p>ANGOLO PARAURTI S.M.C. - GRIGIO - SENZA FORO FENDI CORNER BUMPER S.M.C. - GREY - W/O HOLE</p> <p>COS.PEL. ref. 405.94358 SIMILAR ref. 9438800370 / 9438809972 DX RH</p> <p>405.94359 9438800270 / 9438809872 SX LH</p>
 <p>cm 62</p>	<p>ANGOLO PARAURTI S.M.C. - GRIGIO - CON FORO FENDI CORNER BUMPER S.M.C. - GREY - WITH HOLE</p> <p>COS.PEL. ref. 405.94360 SIMILAR ref. 9438800173 / A9438800770-7354 DX RH</p> <p>405.94361 9438800073 / A9438800670-7354 SX LH</p>
	<p>PARAURTI CENTRALE SUPERIORE S.M.C. - GRIGIO UPPER CENTRE BUMPER S.M.C. - GREY</p> <p>COS.PEL. ref. 405.94362 SIMILAR ref. A9438850201-7354</p>
	<p>PARAURTI CENTRALE INFERIORE S.M.C. - GRIGIO BUMPER LOWER CENTRAL PART S.M.C. - GREY</p> <p>COS.PEL. ref. 405.94363 SIMILAR ref. A9438850226 / A9438850426-7354</p>
 <p>cm 89</p>	<p>ANGOLO PARAURTI MEGA SPACE S.M.C. - GRIGIO CORNER BUMPER MEGA SPACE S.M.C. - GREY</p> <p>COS.PEL. ref. 405.94368 SIMILAR ref. 9438804373 / 9438807470 / 9438809870 DX RH</p> <p>405.94369 9438807570 SX LH</p>

ActrosMP3/MegaSpaceMP3

	<p>PARAURTI CENTRALE MEGA SPACE S.M.C. - GRIGIO CENTRAL BUMPER MEGA SPACE S.M.C. - GREY</p> <p>COS.PEL. ref. SIMILAR ref. 405.94370 9438850301</p>
	<p>ANGOLO PARAURTI CON PRESA ARIA E FORO FENDI S.M.C. - GRIGIO - PIU' FORI CORNICE CORNER BUMPER W/HOLE S.M.C. - GREY</p> <p>COS.PEL. ref. SIMILAR ref. 405.94376 9438800104 / 9438804573 / 9438807270 DX RH</p> <p>405.94377 9438800004 / 9438804473 / 9438807370 SX LH</p>
	<p>ANGOLO PARAURTI CON FORO FENDI E PRESA D'ARIA CORNER BUMPER WITH HOLES</p> <p>COS.PEL. ref. SIMILAR ref. 405.94394 9438804972-7354 DX RH</p> <p>405.94393 9438804872-7354 SX LH</p>
	<p>ANGOLO PARAURTI CON FORO FENDI E PRESA D'ARIA - S.M.C. - GRIGIO CORNER BUMPER W/HOLE WITH HOLES - S.M.C. - GREY</p> <p>COS.PEL. ref. SIMILAR ref. 405.94396 9438806172-7354 DX RH</p> <p>405.94395 9438806072-7354 SX LH</p>
	<p>ANGOLO SOTTOPARAURTI BASSO H 19,5 CM LOWER SPOILER H 19,5 CM</p> <p>COS.PEL. ref. SIMILAR ref. 405.94382 9438851725 DX RH</p> <p>405.94383 9438851625 SX LH</p>
	<p>SOTTOPARAURTI CENTRALE TIPO BASSO H 19,5 CM LOWER CENTER SPOILER H 19,5 CM</p> <p>COS.PEL. ref. SIMILAR ref. 405.94384 9438851825</p>
	<p>ANGOLO SOTTOPARAURTI ALTO H 23,5 CM HIGH SPOILER H 23,5 CM</p> <p>COS.PEL. ref. SIMILAR ref. 405.94386 9438851225 DX RH</p> <p>405.94385 9438851125 SX LH</p>
	<p>SOTTOPARAURTI CENTRALE TIPO ALTO H 23,5 CM HIGH CENTER SPOILER H 23,5 CM</p> <p>COS.PEL. ref. SIMILAR ref. 405.94387 9438851325</p>









ActrosMP3/MegaSpaceMP3

	<p>RIVESTIMENTO ANGOLO SOTTOPARAURTI BASSO COVER FOR LOWER SPOILER</p> <p>COS.PEL. ref. SIMILAR ref. 405.94388 9438851522 DX RH</p> <p>405.94389 9438851422 SX LH</p>
	<p>RIVESTIMENTO SOTTOPARAURTI CENTRALE ALTO COVER FOR LOWER CENTRAL SPOILER</p> <p>COS.PEL. ref. SIMILAR ref. 405.94390 A9438851322 DX RH</p> <p>405.94391 A9438851222 SX LH</p>
	<p>RIVESTIMENTO PARTE CENTRALE SOTTOPARAURTI COVER FOR LOWER CENTER SPOILER</p> <p>COS.PEL. ref. SIMILAR ref. 405.94392 9438851122</p>
	<p>PRESA D'ARIA PARAURTI AIR DEFLECTOR BUMPER</p> <p>COS.PEL. ref. SIMILAR ref. 405.94378 9438850163 DX RH</p> <p>405.94379 9438850063 SX LH</p>
	<p>PLASTICA PRESA D'ARIA COVER FOR FRONT SIDE BUMPER</p> <p>COS.PEL. ref. SIMILAR ref. 405.94380 9438840160 DX RH</p> <p>405.94381 9438840060 SX LH</p>
	<p>COPPA PARTE POSTERIORE CROMATO CROMATO REAR HOUSING CHROME CHROME</p> <p>COS.PEL. ref. SIMILAR ref. 505.94306 - DX RH</p> <p>505.94307 - SX LH</p>
	<p>SPECCHIO RETROVISORE CROMATO ELETTRICO - RISCALDATO - CROMATO REAR-VIEW MIRROR CHROME ELETTRIC - HEATED - CHROME</p> <p>COS.PEL. ref. SIMILAR ref. 505.94308 - DX RH</p> <p>505.94309 - SX LH</p>
	<p>SPECCHIO RETROVISORE GRIGIO ELETTRICO - RISCALDATO - GRIGIO REAR-VIEW MIRROR GREY ELETTRIC - HEATED - GREY</p> <p>COS.PEL. ref. SIMILAR ref. 505.94310 9438106016 DX RH</p> <p>505.94311 9438105816 SX LH</p>

ActrosMP3/MegaSpaceMP3

	<p>VETRO SPECCHIO RISCALDATO MIRROR GLASS HEATED</p> <p>COS.PEL. ref. SIMILAR ref. 505.94312 0028113433 DX RH</p> <p>505.94313 0028113333 SX LH</p>
	<p>VETRO SPECCHIO GRANDANGOLO - RISCALDATO MIRROR GLASS WIDE ANGLE - HEATED</p> <p>COS.PEL. ref. SIMILAR ref. 505.94314 0028113833 DX RH</p> <p>505.94315 0028113733 SX LH</p>
	<p>COPPA HOUSING</p> <p>COS.PEL. ref. SIMILAR ref. 505.94316 0028102716 DX RH</p> <p>505.94317 0028102616 SX LH</p>
	<p>COPPA PARTE POSTERIORE GRIGIO GRIGIO REAR HOUSING GREY GREY</p> <p>COS.PEL. ref. SIMILAR ref. 505.94318 9438110407 DX RH</p> <p>505.94319 9438110307 SX LH</p>
	<p>PLASTICA COPRIBRACCIO PLASTIC COVER ARM</p> <p>COS.PEL. ref. SIMILAR ref. 505.94320 0028102516 DX RH</p> <p>505.94321 0028102416 SX LH</p>
	<p>BRACCIO ARM</p> <p>COS.PEL. ref. SIMILAR ref. 505.94322 0028103314 DX RH</p> <p>505.94323 0028103214 SX LH</p>
	<p>SUPPORTO VETRO Per 505.94316/7 HOUSING For 505.94316/7</p> <p>COS.PEL. ref. SIMILAR ref. 505.94326 -</p>
	<p>SPECCHIO GUARDARUOTA MANUALE ROOF MIRROR MANUAL</p> <p>COS.PEL. ref. SIMILAR ref. 505.94327 9418102116 / A9418101016</p> <p>Modelli dal 10/2004 - Models from 10/2004 on</p>

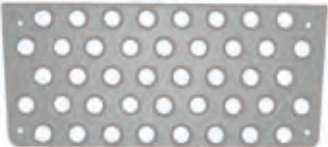
ActrosMP3/MegaSpaceMP3

	<p>SPECCHIO GUARDARUOTA ROOF MIRROR</p> <p>COS.PEL. ref. 505.96519 SIMILAR ref. A0028106016</p>
	<p>VISIERA ACTROS MP3 CON STAFFE CON STAFFE SUN VISOR ACTROS MP3 WITH BRACKET KIT WITH BRACKET KIT</p> <p>COS.PEL. ref. 705.94312 SIMILAR ref. 9438100610</p>
	<p>VISIERA CON STAFFE TETTO ALTO SUN VISOR WITH BRACKETS HIGH CAB</p> <p>COS.PEL. ref. 705.94313 SIMILAR ref. 9438100410</p>
	<p>CONVOGLIATORE ARIA PARTE INTERNA AIR DEFLECTOR INNER</p> <p>COS.PEL. ref. 905.94376 SIMILAR ref. 9438841822 DX RH</p> <p>905.94377 9438841722 SX LH</p>
	<p>CONVOGLIATORE ARIA PARTE ESTERNA AIR DEFLECTOR OUTER</p> <p>COS.PEL. ref. 905.94378 SIMILAR ref. 9438842022 DX RH</p> <p>905.94379 9438841922 SX LH</p>
	<p>GRIGLIA INFERIORE PEDANA FOOTSTEP LOWER</p> <p>COS.PEL. ref. 1005.94000 SIMILAR ref. 9406660428</p>
	<p>GRIGLIA SUPERIORE PEDANA FOOTSTEP UPPER</p> <p>COS.PEL. ref. 1005.94001 SIMILAR ref. 9406660128</p>
	<p>GRIGLIA PEDANA INFERIORE LOWER FOOTSTEP GRILLE</p> <p>COS.PEL. ref. 1005.94300 SIMILAR ref. 9416663428 DX-SX RH-LH</p> <p>Relativa pedana: 305.94104/5</p>

ActrosMP3/MegaSpaceMP3

	<p>GRIGLIA PEDANA INFERIORE LOWER FOOTSTEP GRILLE</p> <p>COS.PEL. ref. SIMILAR ref. 1005.94302 9416663828 DX RH</p> <p>1005.94303 9416663728 SX LH</p>
	<p>GRIGLIA PEDANA SUPERIORE UPPER FOOTSTEP GRILLE</p> <p>COS.PEL. ref. SIMILAR ref. 1005.94304 9416663528 DX-SX RH-LH</p>
	<p>GRIGLIA PEDANA SUPERIORE UPPER FOOTSTEP GRILLE</p> <p>COS.PEL. ref. SIMILAR ref. 1005.94305 9416663328 DX-SX RH-LH</p> <p>Relativa pedana: 305.94104/5</p>
	<p>PROLUNGA PORTA PARTE INTERNA FRONT DOOR LOWER COVER INSIDE</p> <p>COS.PEL. ref. SIMILAR ref. 1405.94102 9417280956 DX RH</p> <p>1405.94103 9417280856 SX LH</p>
	<p>PROLUNGA PORTA PARTE ESTERNA FRONT DOOR LOWER COVER INSIDE</p> <p>COS.PEL. ref. SIMILAR ref. 1405.94104 9417200448 DX RH</p> <p>1405.94105 9417200348 SX LH</p>
	<p>FANALINO LUCE DIURNA LED CORNER LAMP LED</p> <p>COS.PEL. ref. SIMILAR ref. 1605.94372 A9438200856 DX RH</p> <p>1605.94373 A9438200756 SX LH</p>
 	<p>PROIETTORE H1 H7 - CORRETTORE ASSETTO MANUALE HEADLAMP H1 H7 - MANUAL LOAD LEVEL ADJUSTEMENT</p> <p>COS.PEL. ref. SIMILAR ref. 1605.94364 A9438201561 DX RH</p> <p>1605.94365 A9438201461 SX LH</p>
 	<p>PROIETTORE H1 H7 - PREDISPOSTO PER CORRETTORE ASSETTO HEADLAMP H1 H7 - SUITABLE FOR LOAD LEVEL ADJUSTEMENT</p> <p>COS.PEL. ref. SIMILAR ref. 1605.94366 A9438201761 DX RH</p> <p>1605.94367 A9438201661 SX LH</p>

ActrosMP3/MegaSpaceMP3

COS.ME

	<p>VETRO PROIETTORE HEADLAMP GLASS</p> <p>COS.PEL. ref. SIMILAR ref. 1605.94368 0008264610</p> <p>1605.94369 0008264710</p> <p style="text-align: right;">DX RH SX LH</p>
	<p>ALZACRISTALLI ELETTRICO WINDOW REGULATOR</p> <p>Elettrico Senza motorino Con pannello Electric W/O motor W/ panel</p> <p>COS.PEL. ref. SIMILAR ref. 1905.94000 0007200179</p> <p>1905.94001 0007200079</p> <p style="text-align: right;">DX RH SX LH</p>
	<p>MOLLA A GAS GAS SPRING</p> <p>Lunghezza [mm] 609 Corsa [mm] 262 Forza scarto [N] 360 Lenght [mm] 609 Stroke [mm] 262 Waste force [N] 360</p> <p>COS.PEL. ref. SIMILAR ref. 2405.94100 A0019808464</p>
	<p>DEFLETTORI LATERALI CON CLIPS SIDOWINDOW DEFLECTORS WITH CLIPS</p> <p>COS.PEL. ref. SIMILAR ref. 3005.00001 -</p>
	<p>KIT PER CONNESSIONI ELETTRICHE CONNETTORE SUPERSEAL 2 vie femmina KIT FOR ELECTRICAL JOINTS Connector SUPERSEAL ways female</p> <p>COS.PEL. ref. SIMILAR ref. 003123 -</p> <p style="text-align: right;">Connettore per la serie 1500.xxxxx</p>
 <p style="text-align: center;">15,2 cm</p>	<p>FANALE POSTERIORE REAR-LIGHT</p> <p>LED - 24V - CONNETTORE POSTERIORE AMP 1.5 LED - 24V - REAR CONNECTOR AMP 1.5</p> <p>COS.PEL. ref. SIMILAR ref. 1500.00000 - 1500.00001 -</p> <p style="text-align: right;">DX RH SX LH</p> <p>Relativo connettore multipolare 003120 Relativo connettore multipolare 003120</p> <p>TRASPARENTE / LENS</p>

BigSpace/GigaSpace/MP4/StreamSpace



COS.ME

	<p>GRIGLIA GRILLE</p> <p>COS.PEL. ref. SIMILAR ref. 105.96149 9618851453</p> <p>CLASSIC SPACE</p>
	<p>GRIGLIA CENTRALE CENTRE GRILLE</p> <p>COS.PEL. ref. SIMILAR ref. 105.96151 9618850153-9135</p>
	<p>GRIGLIA LATERALE INFERIORE LOWER LATERAL GRILLE</p> <p>COS.PEL. ref. SIMILAR ref. 105.96152 9608852684-9135 DX RH</p> <p>105.96153 9608852584-9135 SX LH</p>
	<p>GRIGLIA GRILLE</p> <p>COS.PEL. ref. SIMILAR ref. 105.96154 9618850053-9135</p>
	<p>RIPAROFANGO POSTERIORE S.M.C. REAR MUDGUARD S.M.C.</p> <p>COS.PEL. ref. SIMILAR ref. 205.96026 9608813403 DX RH</p> <p>205.96025 9608813503 / 9608817102 SX LH</p>

ALL ITEMS MENTIONED IN OUR CATALOGUE ARE NOT ORIGINAL PARTS BUT PERFECTLY INTERCHANGEABLE WITH THEM.

GOVERNING LEGISLATIONS FOR THE SALE OF OUR PRODUCTS DIFFER IN EACH COUNTRY.

INFRINGEMENTS, IF ANY, OF LOCAL LEGISLATIONS ARE RESPONSIBILITY OF THE RETAILER IN THE COUNTRY OF FINAL DISTRIBUTION.



BigSpace/GigaSpace/MP4/StreamSpace

	<p>COPRI PARAFANGO LATERALE REAR MUDGUARD COVER</p> <p>COS.PEL. ref. 205.96028 SIMILAR ref. 9608816903-7G99 DX RH</p> <p>205.96027 9608816803-7G99 SX LH</p>
	<p>CALOTTA BASSA CON 4 TIRANTI P.P. - GRIGIO MUDGUARD LOW WITH 4 MUDGUARD TENSIONERS P.P. - GREY</p> <p>COS.PEL. ref. 205.96018 SIMILAR ref. 9605200067 / A9605200007 DX-SX RH-LH</p>
	<p>CALOTTA ALTA CON 4 TIRANTI P.P. - GRIGIO MUDGUARD HIGH WITH 4 MUDGUARD TENSIONERS P.P. - GREY</p> <p>COS.PEL. ref. 205.96019 SIMILAR ref. 9605200067 / A9605200107 DX-SX RH-LH</p>
	<p>CALOTTA BASSA P.P. - GRIGIO MUDGUARD LOW P.P. - GREY</p> <p>COS.PEL. ref. 205.96020 SIMILAR ref. A9605200007</p> <p>Relativo tirante 1005.96001 - (205.96018 versione con i tiranti)</p>
	<p>CALOTTA ALTA P.P. - GRIGIO MUDGUARD HIGH P.P. - GREY</p> <p>COS.PEL. ref. 205.96021 SIMILAR ref. A9605200107 DX-SX RH-LH</p> <p>Relativo tirante 1005.96001 - (205.96019 versione con i tiranti)</p>
	<p>PARAFANGO POSTERIORE PARTE POSTERIORE P.P. - NERO - SENZA STAFFE - CON ANTISPRAY REAR MUDGUARD REAR PART P.P. - BLACK - W/O BRACKETS - WITH ANTISPRAY</p> <p>COS.PEL. ref. 205.96022 SIMILAR ref. A9605200520 DX-SX RH-LH</p>
	<p>PARAFANGO POSTERIORE PARTE ANTERIORE P.P. - GRIGIO - SENZA STAFFE REAR MUDGUARD FRONT PART P.P. - GREY - W/O BRACKETS</p> <p>COS.PEL. ref. 205.96024 SIMILAR ref. 9605200119 DX RH</p> <p>205.96023 9605200019 SX LH</p>
	<p>PEDANA ALTA P.P.G.F. - PRIMER - CON FORO LUCE CORTESIA HIGH FOOSTEP P.P.G.F. - PRIMER - WITH LAMP HOLE</p> <p>COS.PEL. ref. 305.96200 SIMILAR ref. 9616661801-9135 DX RH</p> <p>305.96201 Griglia/Grille : 305.96204 inf - 305.96204 sup 9616661601-9135 SX LH</p> <p>Griglia/Grille : 305.96204 inf - 305.96204 sup</p>

BigSpace/GigaSpace/MP4/StreamSpace

	<p>PEDANA BASSA P.P.G.F. - GRIGIO FOOSTEP LOW P.P.G.F. - GREY COS.PEL. ref. SIMILAR ref.</p> <p>305.96202 9606661903-7277 / 9606662103-7277 Griglia/Grille : 305.96204 inf - 305.96204 sup</p> <p>305.96203 9606661703-7277 Griglia/Grille : 305.96204 inf - 305.96204 sup</p> <p style="text-align: right;">DX RH SX LH</p>
	<p>PIASTRA PEDANA INFERIORE SUPERIORE FOOTSTEP</p> <p>COS.PEL. ref. SIMILAR ref.</p> <p>305.96204 9606662228</p> <p style="text-align: right;">DX-SX RH-LH</p>
	<p>PEDANA ALTA P.P.G.F. - GRIGIA FOOSTEP HIGH P.P.G.F. - GREY COS.PEL. ref. SIMILAR ref.</p> <p>305.96206 9616661801-7277</p> <p> Griglia/Grille : 305.96204 inf - 305.96204 sup</p> <p>305.96205 9616661601-7277 Griglia/Grille : 305.96204 inf - 305.96204 sup</p> <p style="text-align: right;">DX RH SX LH</p>
	<p>PEDANA BASSA P.P.G.F. - PRIMER LOW FOOSTEP P.P.G.F. - PRIMER COS.PEL. ref. SIMILAR ref.</p> <p>305.96208 9606662103-9135</p> <p> Griglia/Grille : 305.96204 inf - 305.96204 sup</p> <p>305.96207 9606661703-9135 Griglia/Grille : 305.96204 inf - 305.96204 sup</p> <p style="text-align: right;">DX RH SX LH</p>
	<p>CORNICE PARAURTI FENDINEBBIA P.P. - NERO HEADLAMP CASE P.P. - BLACK COS.PEL. ref. SIMILAR ref.</p> <p>405.96086 9608857974</p> <p>405.96087 9608857874</p> <p style="text-align: right;">DX RH SX LH</p>
	<p>CORNICE PARAURTI FENDINEBBIA P.P. - NERO HEADLAMP CASE P.P. - BLACK COS.PEL. ref. SIMILAR ref.</p> <p>405.96088 9608853774</p> <p>405.96089 9608853674</p> <p style="text-align: right;">DX RH SX LH</p>
	<p>ANGOLO PARAURTI ALTO P.P. - PRIMER CORNER BUMPER HIGH P.P. - PRIMER COS.PEL. ref. SIMILAR ref.</p> <p>405.96090 A9608855025-9135</p> <p>405.96091 A9608854925-9135</p> <p style="text-align: right;">DX RH SX LH</p>
	<p>PARAURTI CENTRALE MP4 BIG/GIGA SPACE P.P. - PRIMER CENTRAL BUMPER BIG/GIGA SPACE P.P. - PRIMER COS.PEL. ref. SIMILAR ref.</p> <p>405.96092 A9608801790-9135</p>

BigSpace/GigaSpace/MP4/StreamSpace

 <p>cm 44,5</p>	<p>ANGOLO PARAURTI BASSO P.P. - GRIGIO CORNER BUMPER LOW P.P. - GREY COS.PEL. ref. SIMILAR ref. 405.96094 A9608854825-7G99 DX RH</p> <p>405.96093 A9608854725-7G99 SX LH</p>
 <p>cm 61</p>	<p>PARAURTI CENTRALE BASSO STREAM SPACE P.P. - GRIGIO CENTRAL BUMPER LOW STREAM SPACE P.P. - GREY COS.PEL. ref. SIMILAR ref. 405.96095 A9608801990-7G99</p>
	<p>CORNICE PARAURTI FENDINEBBIA P.P. - NERO BUMPER FOG LAMP HEADLIGHT BEZEL P.P. - BLACK COS.PEL. ref. SIMILAR ref. 405.96096 A9608853974 DX RH</p> <p>405.96097 A9608853874 SX LH</p>
	<p>PEDANA PARAURTI P.P. FOOTSTEP FOR BUMPER P.P. COS.PEL. ref. SIMILAR ref. 405.96098 A9608850311</p>
	<p>TAPPO PARAURTI P.P. - PRIMER COVER BUMPER P.P. - PRIMER COS.PEL. ref. SIMILAR ref. 405.96099 A9608852108-9135</p>
	<p>COPERCHIO CENTRALE PARAURTI P.P. - GRIGIO CENTRAL COVER BUMPER P.P. - GREY COS.PEL. ref. SIMILAR ref. 405.96100 A9608850181</p>
 <p>cm 51</p>	<p>ANGOLO PARAURTI ALTO P.P. - GRIGIO CORNER BUMPER HIGH P.P. - GREY COS.PEL. ref. SIMILAR ref. 405.96102 9608855025-7G99 DX RH</p> <p>405.96101 9608854925-7G99 SX LH</p>
 <p>cm 67</p>	<p>PARAURTI CENTRALE MP4 BIG/GIGA SPACE P.P. - GRIGIO CENTRAL BUMPER BIG/GIGA SPACE P.P. - GREY COS.PEL. ref. SIMILAR ref. 405.96103 9608801790-7G99</p>

BigSpace/GigaSpace/MP4/StreamSpace

 <p>cm 44,5</p>	<p>ANGOLO PARAURTI BASSO P.P. - PRIMER LOW CORNER BUMPER P.P. - PRIMER COS.PEL. ref. SIMILAR ref. 405.96104 A9608854825-9135 DX RH</p> <p>405.96105 A9608854725-9135 SX LH</p>
 <p>cm 61</p>	<p>PARAURTI CENTRALE MP4 STREAM SPACE P.P. - PRIMER CENTRAL BUMPER STREAM SPACE P.P. - PRIMER COS.PEL. ref. SIMILAR ref. 405.96106 A9608801990-9135</p>
	<p>ANGOLO PARAURTI ALTO MP4 P.P. - PRIMER CORNER BUMPER HIGH MP4 P.P. - PRIMER COS.PEL. ref. SIMILAR ref. 405.96108 9608850538-9135 DX RH</p> <p>405.96107 9608850438-9135 SX LH</p>
	<p>ANGOLO PARAURTI ALTO MP4 P.P. - GRIGIO CORNER BUMPER HIGH MP4 P.P. - GREY COS.PEL. ref. SIMILAR ref. 405.96110 9608850538-7G99 DX RH</p> <p>405.96109 9608850438-7G99 SX LH</p>
	<p>SPECCHIO RETROVISORE ELETTRICO - RISCALDATO - BRACCIO CORTO REAR-VIEW MIRROR ELECTRIC + HEATED - SHORT ARM COS.PEL. ref. SIMILAR ref. 505.96500 9608104716 DX RH</p> <p>505.96501 9608103516 SX LH con sensore</p>
	<p>SPECCHIO RETROVISORE ELETTRICO - RISCALDATO - BRACCIO LUNGO REAR-VIEW MIRROR ELECTRIC + HEATED - LONG ARM COS.PEL. ref. SIMILAR ref. 505.96502 9608103416 / 9608104316 DX RH</p> <p>505.96503 9608103316 SX LH con sensore</p>
	<p>COPERCHIO RETROVISORE SUPERIORE BRACCIO CORTO REAR VIEW COVER UPPER SHORT ARM COS.PEL. ref. SIMILAR ref. 505.96504 9608111107 DX RH</p> <p>505.96505 9608111007 SX LH</p>
	<p>COPERCHIO RETROVISORE SUPERIORE BRACCIO LUNGO REAR VIEW COVER UPPER LONG ARM COS.PEL. ref. SIMILAR ref. 505.96506 9608110707 DX RH</p> <p>505.96507 9608110607 SX LH</p>

BigSpace/GigaSpace/MP4/StreamSpace

	<p>COPERCHIO RETROVISORE INFERIORE REAR VIEW COVER LOWER</p> <p>COS.PEL. ref. 505.96508 SIMILAR ref. 9608111507 DX RH</p> <p>505.96509 9608111407 SX LH</p>
	<p>VETRO SPECCHIO RISCALDATO MIRROR GLASS HEATED</p> <p>COS.PEL. ref. 505.96510 SIMILAR ref. A0028116433 DX RH</p> <p>505.96511 A0028116333 SX LH</p>
	<p>VETRO SPECCHIO RISCALDATO MIRROR GLASS HEATED</p> <p>COS.PEL. ref. 505.96512 SIMILAR ref. A0028116633 DX RH</p> <p>505.96513 A0028116533 SX LH</p>
	<p>SPECCHIO GUARDARUOTA ROOF MIRROR</p> <p>COS.PEL. ref. 505.96519 SIMILAR ref. A0028106016</p>
 <p>cm 235</p>	<p>VISIERA PARASOLE GIGA SPACE / BIG SPACE Per cabina 2500 sagomata per specchio DX SUN VISOR GIGA SPACE / BIG SPACE</p> <p>COS.PEL. ref. 705.96900 SIMILAR ref. A9608110110 / A9608112310</p> <p>Relativo kit staffe 1005.96900</p>
 <p>cm 235</p>	<p>VISIERA PARASOLE CON FORI - Per cabina 2500 sagomata per specchio DX SUN VISOR WITH HOLES</p> <p>COS.PEL. ref. 705.96901 SIMILAR ref. A9608111210 / A9608113010</p> <p>Relativo kit staffe 1005.96901</p>
 <p>cm 220</p>	<p>VISIERA PARASOLE CON FORI - Per cabina 2300 sagomata per specchio DX SUN VISOR WITH HOLES</p> <p>COS.PEL. ref. 705.96902 SIMILAR ref. 9608110010 / 9608112210</p> <p>Relativo kit staffe 1005.96902</p>
 <p>cm 272</p> <p>cm 76</p>	<p>CARENATURA LATERALE (3700mm.) (PASSO 3700mm) - STRATIFICAZIONE MANUALE - BIANCO FAIRING (WHEEL BASE 3700mm) - G.R.P. - WHITE</p> <p>COS.PEL. ref. 805.96802 SIMILAR ref. A96052040559135 / A96052083559135 DX RH</p> <p>805.96801 A96052065559135 / A96052066559135 / A96052082559135 SX LH</p>

BigSpace/GigaSpace/MP4/StreamSpace









	<p>DEFLETTORE (PARTE ESTERNA) P.P. DEFLECTOR (OUTER) P.P. COS.PEL. ref. SIMILAR ref. 905.96172 9607511330 DX RH</p> <p>905.96171 9607511230 SX LH</p>
	<p>DEFLETTORE (PARTE INTERNA) P.P. DEFLECTOR (INNER) P.P. COS.PEL. ref. SIMILAR ref. 905.96174 9607510730 DX RH</p> <p>905.96173 9607510630 SX LH</p>
	<p>CORNICE PLASTICA A.B.S. HEAD LAMP EXTENSION (PLASTIC) A.B.S. COS.PEL. ref. SIMILAR ref. 905.96176 9608804005-9135 DX RH</p> <p>905.96175 9608803905-9135 SX LH</p>
	<p>CORNICE SUPERIORE PLASTICA P.P. HEAD LAMP UPPER EXTENSION (PLASTIC) P.P. COS.PEL. ref. SIMILAR ref. 905.96178 9608859508-9135 DX RH</p> <p>905.96177 9608859408-9135 SX LH</p>
	<p>FIANCHETTO ANTERIORE AIR DEFLECTOR COS.PEL. ref. SIMILAR ref. 905.96180 9607511130 DX RH</p> <p>905.96179 9607511030 SX LH</p>
	<p>DEVIATORE ARIA AIR BAFFLE COS.PEL. ref. SIMILAR ref. 905.96182 9607510530 DX RH</p> <p>905.96181 9607510430 SX LH</p>
	<p>SUPPORTO FARO HEADLAMP FRAME COS.PEL. ref. SIMILAR ref. 1105.96500 9608802703 DX RH</p> <p>1105.96501 9608802603 SX LH CLASSIC SPACE / STREAM SPACE</p> <p>CLASSIC SPACE / STREAM SPACE</p>
	<p>SUPPORTO FARO HEADLAMP FRAME COS.PEL. ref. SIMILAR ref. 1105.96502 9608803403 DX RH</p> <p>1105.96503 9608803303 SX LH CLASSIC SPACE / STREAM SPACE</p> <p>CLASSIC SPACE / STREAM SPACE</p>

BigSpace/GigaSpace/MP4/StreamSpace

COS.ME

	<p>PROLUNGA PORTA S.M.C. DOOR EXTENSION S.M.C.</p> <p>COS.PEL. ref. SIMILAR ref. 1405.96100 9607201001-7277 DX RH</p> <p>1405.96101 9607200901-7277 SX LH</p> <p>BIG SPACE / GIGA SPACE BIG SPACE / GIGA SPACE</p>
	<p>PROLUNGA PORTA DOOR EXTENSION</p> <p>COS.PEL. ref. SIMILAR ref. 1405.96102 9607201201-7277 DX RH</p> <p>1405.96103 9607201101-7277 SX LH</p> <p>STREAM SPACE / CLASSIC SPACE STREAM SPACE / CLASSIC SPACE</p>
 	<p>FANALINO LATERALE P21 5W CORNER LAMP P21 5W</p> <p>COS.PEL. ref. SIMILAR ref. 1605.96110 9608201121 DX RH</p> <p>1605.96111 9608201021 SX LH</p>
 	<p>PROIETTORE H7-H1-PY21W-W5W HEADLAMP H7-H1-PY21W-W5W</p> <p>COS.PEL. ref. SIMILAR ref. 1605.96100 9608200339 DX RH</p> <p>1605.96101 9608200239 SX LH</p>
 	<p>PROIETTORE XENON HID SENZA CENTRALINA D1S-H1-PY21W-W5W XENON HEADLAMP HID W/O CONTROL UNIT D1S-H1-PY21W-W5W</p> <p>COS.PEL. ref. SIMILAR ref. 1605.96102 9608200739 DX RH</p> <p>1605.96103 9608200639 SX LH</p>
 	<p>PROIETTORE H7-H1-PY21W-W5W-H21W - DAYTIME RUNNING LAMP LAMP H7-H1-PY21W-W5W-H21W - DAYTIME RUNNING LAMP</p> <p>COS.PEL. ref. SIMILAR ref. 1605.96104 9608200539 DX RH</p> <p>1605.96105 9608200439 SX LH</p>
	<p>STRISCIA LED LED STRIP</p> <p>COS.PEL. ref. SIMILAR ref. 1605.96106 A9608201056 DX RH</p> <p>1605.96107 A9608200956 SX LH</p>
 	<p>PROIETTORE FENDINEBBIA H11 FOG LAMP H11</p> <p>COS.PEL. ref. SIMILAR ref. 1605.96108 A9608200556 DX RH</p> <p>1605.96109 A9608200456 SX LH</p>

BigSpace/GigaSpace/MP4/StreamSpace

	<p>PROIETTORE SENZA CENTRALINA D1S H1 PY21W H21W W5W HEADLAMP W/O CONTROL UNIT D1S H1 PY21W H21W W5W COS.PEL. ref. SIMILAR ref. 1605.96112 A9608200939 DX RH</p> <p>1605.96113 A9608200839 SX LH</p>
	<p>MANIGLIA PORTA SENZA CHIAVE DOOR HANDLE WITHOUT KEY COS.PEL. ref. SIMILAR ref. 1705.96100 9607230709 DX RH</p> <p>1705.96101 9607230609 SX LH</p>
	<p>TIRANTE PARAFANGO POSTERIORE GOMMA - NERO MUDGUARD TENSIONER RUBBER - BLACK COS.PEL. ref. SIMILAR ref. 1005.96001 9605200067</p>
	<p>SUPPORTO STAFFA PARAFANGO METALLO - NERO - SENZA BULLONE MUDGUARD BRACKET STEEL - BLACK - WITHOUT BOLT COS.PEL. ref. SIMILAR ref. 1005.96002 A9605211540</p>
	<p>SUPPORTO STAFFA PARAFANGO METALLO - NERO - CON DADO MUDGUARD BRACKET STEEL - BLACK - WITH BOLT COS.PEL. ref. SIMILAR ref. 1005.96003 -</p>
	<p>DEFLETTORI LATERALI CON CLIPS SIDEWINDOW DEFLECTORS WITH CLIPS COS.PEL. ref. SIMILAR ref. 3005.00000 -</p>
	<p>KIT PER CONNESSIONI ELETTRICHE Connettore SUPERSEAL 2 vie femmina KIT FOR ELECTRICAL JOINTS Connector SUPERSEAL ways female COS.PEL. ref. SIMILAR ref. 003123 - Connettore per la serie 1500.xxxxx</p>
	<p>FANALE POSTERIORE REAR-LIGHT COS.PEL. ref. SIMILAR ref. 009610 A0035441803 DX RH</p> <p>009611 A0035441703 SX LH Con luce targa / With plate light</p> <p>TRASPARENTE / LENS 096300 A0025447390 DX-SX RH-LH</p>

BigSpace/GigaSpace/MP4/StreamSpace

 <p>cm 13,8</p>	<p>FANALE POSTERIORE REAR-LIGHT CON CICALINO WITH BUZZER</p> <p>COS.PEL. ref. SIMILAR ref. 009612 -</p> <p>DX RH</p> <p>TRASPARENTE / LENS 096300 A0025447390 DX-SX RH-LH</p>
 <p>15,2 cm</p>	<p>FANALE POSTERIORE REAR-LIGHT LED - 24V - CONNETTORE POSTERIORE AMP 1.5 LED - 24V - REAR CONNECTOR AMP 1.5</p> <p>COS.PEL. ref. SIMILAR ref. 1500.00000 - 1500.00001 -</p> <p>DX RH SX LH</p> <p>Relativo connettore multipolare 003120 Relativo connettore multipolare 003120</p> <p>TRASPARENTE / LENS</p>



<p>AD ESAURIMENTO SCORTE UNTIL STILL-OUT</p> 	<p>PARAURTI CENTRALE CENTRAL BUMPER</p> <p>COS.PEL. ref. SIMILAR ref. 415.00090 A6288850401</p>
<p>AD ESAURIMENTO SCORTE UNTIL STILL-OUT</p> 	<p>PARAURTI CENTRALE POSTERIORE REAR CENTRE BUMPER</p> <p>COS.PEL. ref. SIMILAR ref. 415.00100 A6288802671</p>
<p>AD ESAURIMENTO SCORTE UNTIL STILL-OUT</p> 	<p>ANGOLO PARAURTI POSTERIORE CON FORO RETRONEBBIA REAR ANGLE BUMPER WITH FOG LAMP HOLE</p> <p>COS.PEL. ref. SIMILAR ref. 415.00104 A6288850505</p> <p style="text-align: right;">DX RH</p>

Citaro 0530



COS.ME

<p>AD ESAURIMENTO SCORTE UNTIL SELL-OUT</p> 	<p>PARAURTI CENTRALE LARGHEZZA 2500 MM - CON 2 FORI CENTRE BUMPER WIDTH 2500 MM - WITH 2 HOLES</p> <p>COS.PEL. ref. SIMILAR ref. 415.00105 A6288800171</p>
<p>AD ESAURIMENTO SCORTE UNTIL SELL-OUT</p> 	<p>ANGOLO PARAURTI CORNER BUMPER</p> <p>COS.PEL. ref. SIMILAR ref.</p> <p>415.00108 A6288850202 DX RH</p> <p>415.00107 A6288850102 SX LH</p>



Parti di ricambio adattabili a:
Spare parts suitable to:



<p>AD ESAURIMENTO SCORTE UNTIL SELL-OUT</p> 	<p>RIVESTIMENTO MONTANTE ANTERIORE A.B.S. EXTERNAL DRIP A.B.S.</p> <p>COS.PEL. ref. SIMILAR ref.</p> <p>106.23100 93924351 DX RH</p> <p>106.23101 93924352 SX LH</p>
<p>AD ESAURIMENTO SCORTE UNTIL SELL-OUT</p> 	<p>CANTONALE POSTERIORE METALLO REAR CORNER PANEL STEEL</p> <p>COS.PEL. ref. SIMILAR ref.</p> <p>106.23102 93914768 DX RH</p> <p>106.23103 93914769 SX LH</p>
<p>AD ESAURIMENTO SCORTE UNTIL SELL-OUT</p> 	<p>COFANO METALLO HOOD STEEL</p> <p>COS.PEL. ref. SIMILAR ref.</p> <p>106.23150 93923150</p>
	<p>PRESA ARIA COFANO A.B.S. - NERO AIR INTAKE ON HOOD A.B.S. - BLACK</p> <p>COS.PEL. ref. SIMILAR ref.</p> <p>106.23151 93924652</p>
	<p>CONVOGLIATORE SOTTO COFANO A.B.S. - NERO HOOD AIR INTAKE A.B.S. - BLACK</p> <p>COS.PEL. ref. SIMILAR ref.</p> <p>106.23152 93924614</p>







	<p>FRONTALE MOD. 95 METALLO FRONT PANEL MOD. 95 STEEL</p> <p>COS.PEL. ref. SIMILAR ref. 106.23737 93923737</p>
	<p>GRIGLIA FRONTALE MOD. 95 A.B.S. - GRIGIO FRONT GRILLE MOD. 95 A.B.S. - GREY</p> <p>COS.PEL. ref. SIMILAR ref. 106.33130 93923758 / 93933130</p>
	<p>FRONTALE MOD. 96 METALLO FRONT PANLE MOD. 96 STEEL</p> <p>COS.PEL. ref. SIMILAR ref. 106.37476 93937476</p>
	<p>GRIGLIA SUPERIORE E INFERIORE MOD. 96 A.B.S. - NERO UPPER AND LOWER GRILLE MOD. 96 A.B.S. - BLACK</p> <p>COS.PEL. ref. SIMILAR ref. 106.37668 93937668 / 93937670</p>
	<p>GRIGLIA CENTRALE MOD. 96 A.B.S. - NERO CENTRE GRILLE MOD. 96 A.B.S. - BLACK</p> <p>COS.PEL. ref. SIMILAR ref. 106.37669 93937669</p>
	<p>PARAFANGO ANTERIORE METALLO MUDGUARD STEEL</p> <p>COS.PEL. ref. SIMILAR ref. 206.23132 93923132 DX RH</p> <p>206.23131 93923131 SX LH</p>
	<p>RIPARO PARAFANGO A.B.S. PROTECTION MUDGUARD A.B.S.</p> <p>COS.PEL. ref. SIMILAR ref. 206.23136 93936994 DX RH</p> <p>206.23137 93936995 SX LH</p>
	<p>PRESA ARIA INTERNA A.B.S. AIR INLET A.B.S.</p> <p>COS.PEL. ref. SIMILAR ref. 206.23138 93933538</p>

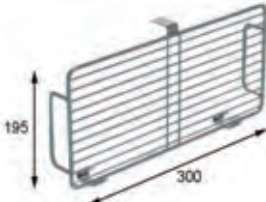

<p>AD ESAURIMENTO SCORTE UNTIL SELL-OUT</p> 	<p>VASCETTA PEDANA A.B.S. - NERO COVER FOOTSTEP A.B.S. - BLACK</p> <p>COS.PEL. ref. SIMILAR ref. 306.35020 93932871</p> <p style="text-align: right;">DX RH</p>
	<p>ANGOLO PARAURTI POSTERIORE P.P. - GRIGIO REAR CORNER BUMPER P.P. - GREY</p> <p>COS.PEL. ref. SIMILAR ref. 406.03510 93926823</p> <p style="text-align: right;">DX RH</p> <p>406.03511 93926824</p> <p style="text-align: right;">SX LH</p>
	<p>CANTONALE PARAURTI POSTERIORE P.P. - GRIGIO REAR CORNER BUMPER P.P. - GREY</p> <p>COS.PEL. ref. SIMILAR ref. 406.03514 93939907</p> <p style="text-align: right;">DX RH</p> <p>406.03513 93939908</p> <p style="text-align: right;">SX LH</p>
	<p>PORTATARGA POSTERIORE P.P. - GRIGIO REAR PLATE P.P. - GREY</p> <p>COS.PEL. ref. SIMILAR ref. 406.03515 93939909</p>
	<p>PARAURTI ANTERIORE P.P.G.F. - GRIGIO SCURO FRONT BUMPER P.P.G.F. - DARK GREY</p> <p>COS.PEL. ref. SIMILAR ref. 406.36915 2997123 / 93936913 / 93938863 / 93941625</p>
	<p>TAPPO PARAURTI COPRIFENDINEBBIA A.B.S. - GRIGIO FOG LAMP COVER A.B.S. - GREY</p> <p>COS.PEL. ref. SIMILAR ref. 406.03850 93934203 / 93936924</p> <p style="text-align: right;">DX RH</p> <p>406.03851 93934202 / 93936925</p> <p style="text-align: right;">SX LH</p>
	<p>BARRA PARAINCASTRO ROSSA (1900 mm) METALLO - PER CASSONI LARGHI mm 1900/2050 REAR BUMPER RED (1900 mm) STEEL - FOR BODY WITH mm 1900/2050</p> <p>COS.PEL. ref. SIMILAR ref. 400.01900 93806655 / 93807247</p> <p style="text-align: center;">1900 mm</p>
	<p>BARRA PARAINCASTRO GRIGIO (1900 mm) METALLO - PER CASSONI LARGHI mm 1900/2050 REAR BUMPER GREY (1900 mm) STEEL - FOR BODY WITH mm 1900/2050</p> <p>COS.PEL. ref. SIMILAR ref. 400.01901 93807247</p> <p style="text-align: center;">1900 mm</p>

	<p>SPECCHIO RETROVISORE BRACCIO CORTO REAR-VIEW MIRROR SHORT ARM COS.PEL. ref. SIMILAR ref. 506.35100 93936853 DX RH</p> <p>506.35101 93936852 SX LH</p>
	<p>SPECCHIO RETROVISORE BRACCIO LUNGO REAR-VIEW MIRROR LONG ARM COS.PEL. ref. SIMILAR ref. 506.35102 93928072 / 93936855 DX RH</p> <p>506.35103 93928073 / 93936854 SX LH</p>
	<p>VETRO SPECCHIO MIRROR GLASS COS.PEL. ref. SIMILAR ref. 506.35104 93160520 / 93160521 DX-SX RH-LH</p>
	<p>COPPA RETROVISORE COVER MIRROR COS.PEL. ref. SIMILAR ref. 506.35105 - DX-SX RH-LH</p>
	<p>VISIERA CON STAFFE CON STAFFE SUN VISOR WITH BRACKET KIT WITH BRACKET KIT COS.PEL. ref. SIMILAR ref. 706.35100 1902779</p>
	<p>SUPPORTO PARAURTI LATERALE METALLO BUMPER BRACKET STEEL COS.PEL. ref. SIMILAR ref. 1006.25034 93924822 DX RH</p> <p>1006.25033 93924823 SX LH</p>
	<p>SUPPORTO PARAURTI METALLO BUMPER BRACKET STEEL COS.PEL. ref. SIMILAR ref. 1006.25036 93925036 DX RH</p> <p>1006.25035 93925035 SX LH</p>
	<p>SUPPORTO PARAURTI METALLO BUMPER BRACKET STEEL COS.PEL. ref. SIMILAR ref. 1006.25038 93928272 DX RH</p> <p>1006.25037 93828917 / 93924973 SX LH</p>

 	<p>FANALINO CORNER LAMP</p> <p>COS.PEL. ref. SIMILAR ref. 1606.33912 98433912</p> <p>1606.33913 98433913</p> <p>DX RH</p> <p>SX LH</p>
 	<p>PROIETTORE H4 - PREDISPOSTO PER CORRETTORE ASSETTO HEADLAMP H4 - SUITABLE FOR LOAD LEVEL ADJUSTMENT</p> <p>COS.PEL. ref. SIMILAR ref. 1606.93900 98433939</p> <p>1606.93901 98433940</p> <p>DX RH</p> <p>SX LH</p>
 	<p>PROIETTORE H4 - CORRETTORE ASSETTO MANUALE HEADLAMP H4 - MANUAL LOAD LEVEL ADJUSTMENT</p> <p>COS.PEL. ref. SIMILAR ref. 1606.93902 98433941</p> <p>1606.93903 98433942</p> <p>DX RH</p> <p>SX LH</p>
	<p>MANIGLIA PORTA CON CHIAVE DOOR HANDLE WITH KEY</p> <p>COS.PEL. ref. SIMILAR ref. 1706.35120 93936135</p> <p>1706.35121 93936134</p> <p>DX RH</p> <p>SX LH</p>
	<p>KIT MANIGLIE GRIGIO SCURO - CON CHIAVE KIT DOOR HANDLE WITH KEY DARK GREY - WITH KEY</p> <p>COS.PEL. ref. SIMILAR ref. 1706.35122 -</p> <p>DX-SX RH-LH</p>
	<p>MANIGLIA PORTA INTERNA INSIDE DOOR HANDLE</p> <p>COS.PEL. ref. SIMILAR ref. 1706.35123 93926687</p> <p>DX-SX RH-LH</p>
	<p>SCONTO SERRATURA PORTA ANTERIORE LOCKING DEVICE</p> <p>COS.PEL. ref. SIMILAR ref. 1706.35126 93924717</p> <p>1706.35125 93924716</p> <p>DX RH</p> <p>SX LH</p>
	<p>SERRATURA INTERNO PORTA INSIDE DOOR LOCK</p> <p>COS.PEL. ref. SIMILAR ref. 1706.35128 93928166</p> <p>1706.35127 93924714</p> <p>DX RH</p> <p>SX LH</p>

	<p>TIRAPORTA INTERNO INNER PULL HANDLE</p> <p>COS.PEL. ref. SIMILAR ref. 1706.35129 93938673</p> <p style="text-align: right;">DX-SX RH-LH</p>
	<p>MANOVELLA ALZACRISTALLO WINDOW REGULATION HANDLE</p> <p>COS.PEL. ref. SIMILAR ref. 1706.35130 93926848 / 93936405</p> <p style="text-align: right;">DX-SX RH-LH</p>
	<p>GUARNIZIONE PARABREZZA WINDSCREEN GASKET</p> <p>COS.PEL. ref. SIMILAR ref. 1806.35012 93902026 / 93926149 / 93940727</p>
	<p>GUARNIZIONE CRISTALLO SCENDENTE GLASS WEATHER STRIP</p> <p>COS.PEL. ref. SIMILAR ref. 1806.35014 503645305 / 93930986</p> <p style="text-align: right;">DX RH</p>
	<p>RASCHIAVETRO INFERIORE ESTERNO GLASSGUIDE WEATER STRIP</p> <p>COS.PEL. ref. SIMILAR ref. 1806.35015 93926317</p> <p style="text-align: right;">SX LH</p>
	<p>RASCHIAVETRO INFERIORE INTERNO GLASS WEATHER STRIP</p> <p>COS.PEL. ref. SIMILAR ref. 1806.35018 93926309</p> <p style="text-align: right;">DX RH</p> <p>1806.35017 93926310</p> <p style="text-align: right;">SX LH</p>
	<p>TRAFILATO VANO PORTA SPEZZONE MT 4,5 DOOR OPENING WEATHER STRIP PIECE L3ENGHT MT 4,5</p> <p>COS.PEL. ref. SIMILAR ref. 1806.35020 93933106 (spezzone)</p>
	<p>GUARNIZIONE COFANO HOOD WEATHER STRIP</p> <p>COS.PEL. ref. SIMILAR ref. 1806.35022 93929967 / 93931353</p>

	<p>TRAFILATO VANO PORTA SPEZZONE MT 25 DOOR OPENING WEATHER STRIP PIECE LENGHT MT 25</p> <p>COS.PEL. ref. SIMILAR ref. 1806.35023 93902121</p>
<p>AD ESAURIMENTO SCORTE UNTIL SPILL-OUT</p> 	<p>ALZACRISTALLI ELETTRICO - CON MOTORINO - 2 PIN WINDOW REGULATOR ELECTRIC - WITH MOTOR - 2 PIN</p> <p>COS.PEL. ref. SIMILAR ref. 1906.96002 2997193 / 4856063 / 99485357 DX RH</p> <p>1906.96001 2997194 / 4856064 / 99485358 SX LH</p>
	<p>ALZACRISTALLI MANUALE WINDOW REGULATOR MANUAL</p> <p>COS.PEL. ref. SIMILAR ref. 1906.96004 2997183 / 93926734 / 93941270 DX RH</p> <p>1906.96003 2997184 / 93926735 / 93941271 SX LH</p>
	<p>PROTEZIONE FARO Per Cos.Ive Daily 96 GRID For Cos.Ive Daily 96</p> <p>COS.PEL. ref. SIMILAR ref. 2000.00010 -</p>
	<p>ANELLO COPRIMOZZO 6 FORI 6 FORI - PLASTICA GRIGIO RING WHEEL COVER 6 HOLES 6 HOLES - PLASTIC GREY</p> <p>COS.PEL. ref. SIMILAR ref. 2000.00200 99477376</p> <p>Ordinabile solo per conf. di 2 pz. / Sold by package of 2 pcs.</p>
<p>AD ESAURIMENTO SCORTE UNTIL SPILL-OUT</p> 	<p>ANELLO COPRIMOZZO 6 FORI 6 FORI - ACCIAIO VERNICIATO NERO RING WHEEL COVER 6 HOLES 6 HOLES - STEEL PAINTED IN BLACK</p> <p>COS.PEL. ref. SIMILAR ref. 2000.00201 -</p> <p>Ordinabile solo per conf. di 2 pz. / Sold by package of 2 pcs.</p>
	<p>ANELLO COPRIMOZZO 6 FORI 6 FORI - ACCIAIO INOX RING WHEEL COVER 6 HOLES 6 HOLES - STAINLESS STEEL</p> <p>COS.PEL. ref. SIMILAR ref. 2000.00202 -</p> <p>Ordinabile solo per conf. di 2 pz. / Sold by package of 2 pcs.</p>
	<p>COPPA COPRIMOZZO 6 FORI 6 FORI - PLASTICA - GRIGIO RING WHEEL COVER 6 HOLES 6 HOLES - PLASTIC - GREY</p> <p>COS.PEL. ref. SIMILAR ref. 2000.00250 93824452</p> <p>Ordinabile solo per conf. di 2 pz. / Sold by package of 2 pcs.</p>

	<p>COPPA COPRIMOZZO 6 FORI 6 HOLES - ACCIAIO INOX WHEEL COVER 6 HOLES 6 HOLES - STAINLESS STEEL</p> <p>COS.PEL. ref. SIMILAR ref. 2000.00251 -</p> <p>Ordinabile solo per conf. di 2 pz. / Sold by package of 2 pcs.</p>
	<p>FANALE POSTERIORE 5 FUNZIONI REAR-LIGHT 5 FUNCTIONS</p> <p>COS.PEL. ref. SIMILAR ref. 003970 1904639 / 1907700 DX RH</p> <p>003980 1904640 / 1907701 SX LH</p> <p>TRASPARENTE / LENS 012621 42471138 / 7984015 DX RH 012721 42471137 / 7984016 SX LH</p>



	<p>GRIGLIA FRONTALE A.B.S. - NERO FRONT GRILLE A.B.S. - BLACK</p> <p>COS.PEL. ref. SIMILAR ref. 106.46218 500328278 / 504046218</p>
	<p>COFANO METALLO HOOD STEEL</p> <p>COS.PEL. ref. SIMILAR ref. 106.71666 99471666</p>
	<p>FRONTALE METALLO FRONT PANEL STEEL</p> <p>COS.PEL. ref. SIMILAR ref. 106.89947 99489947</p>
	<p>PARAFANGO ANTERIORE METALLO FRONT MUDGUARD STEEL</p> <p>COS.PEL. ref. SIMILAR ref. 206.23134 99489371 / 99489793 DX RH</p> <p>206.23133 99489794 / 99489805 SX LH</p>
	<p>MODANATURA EMBELLISHER</p> <p>COS.PEL. ref. SIMILAR ref. 206.23140 500326798 DX RH</p> <p>206.23139 500326797 SX LH</p>

	<p>RIVESTIMENTO P.P. - GRIGIO FACING P.P. - GREY COS.PEL. ref. SIMILAR ref. 206.23142 500326801 DX RH</p> <p>206.23141 500326802 SX LH</p>
	<p>RIVESTIMENTO PEDANA P.P. - GRIGIO PLASTIC STEPLINING P.P. - GREY COS.PEL. ref. SIMILAR ref. 306.33100 500312441 DX RH</p> <p>306.33101 500312439 SX LH</p>
	<p>PARAURTI ANTERIORE P.P. - GRIGIO BUMPER P.P. - GREY COS.PEL. ref. SIMILAR ref. 406.33905 2997500 / 500333905</p>
	<p>PARAURTI ANTERIORE CON FORI P.P. - GRIGIO FRONT BUMPER WITH HOLES P.P. - GREY COS.PEL. ref. SIMILAR ref. 406.33907 2997499 / 500333907</p>
	<p>PARAURTI ANTERIORE CON FORI P.P. - NERO FRONT BUMPER WITH HOLES P.P. - BLACK COS.PEL. ref. SIMILAR ref. 406.33909 2997493 / 500054914 / 504099353</p>
	<p>PARAURTI ANTERIORE P.P. - NERO FRONT BUMPER P.P. - BLACK COS.PEL. ref. SIMILAR ref. 406.33910 2997495 / 504099351</p>
	<p>CANTONALE PARAURTI POSTERIORE P.P. - GRIGIO REAR CORNER BUMPER P.P. - GREY COS.PEL. ref. SIMILAR ref. 406.33920 500326836 DX RH</p> <p>406.33921 500326835 SX LH</p>
	<p>CANTONALE PARAURTI POSTERIORE P.P. - NERO REAR CORNER BUMPER P.P. - BLACK COS.PEL. ref. SIMILAR ref. 406.33922 504099511 DX RH</p> <p>406.33923 504099512 SX LH</p>

Daily S2000

	<p>PEDANA PARAURTI P.P. - GRIGIO FOOTSTEP BUMPER P.P. - GREY</p> <p>COS.PEL. ref. 406.33900 SIMILAR ref. 504009774</p>
	<p>CANTONALE BARRA PARAINCASTRO A.B.S. - NERO CORNER FOR BUMPER A.B.S. - BLACK</p> <p>COS.PEL. ref. 400.00001 SIMILAR ref. 500326871</p>
 <p style="text-align: center;">cm 180</p>	<p>BARRA PARAINCASTRO METALLO - NERA REAR BUMPER STEEL - BLACK</p> <p>COS.PEL. ref. 400.02000 SIMILAR ref. 500326870</p> <p style="text-align: right;">Cassoni fino a 2000 mm</p>
 <p style="text-align: center;">cm 180</p>	<p>BARRA PARAINCASTRO METALLO - GRIGIA REAR BUMPER STEEL - GREY</p> <p>COS.PEL. ref. 400.02001 SIMILAR ref. 500332454</p> <p style="text-align: right;">Cassoni fino a 2000 mm</p>
<p style="color: red; font-size: small;">AD ESAURIMENTO SCORTE UNTIL SPILL-OUT</p> 	<p>SPECCHIO RETROVISORE ELETTRICO BRACCIO LUNGO REAR-VIEW MIRROR ELECTRIC LONG ARM</p> <p>COS.PEL. ref. 506.38094 SIMILAR ref. 500325748 / 504056893 DX RH</p> <p>506.38095 500325747 / 504056898 SX LH</p>
	<p>SPECCHIO RETROVISORE RISCALDATO MANUALE BRACCIO CORTO REAR-VIEW MIRROR HEATED MANUAL SHORT ARM</p> <p>COS.PEL. ref. 506.38096 SIMILAR ref. 500325709 / 500325711 / 504056878 DX RH</p> <p>506.38097 500325708 / 500325710 / 504056864 SX LH</p>
<p style="color: red; font-size: small;">AD ESAURIMENTO SCORTE UNTIL SPILL-OUT</p> 	<p>SPECCHIO RETROVISORE MANUALE BRACCIO MEDIO REAR-VIEW MIRROR MANUAL MIDDLE ARM</p> <p>COS.PEL. ref. 506.38098 SIMILAR ref. 500325726 DX RH</p> <p>506.38099 500325725 SX LH</p>
	<p>VETRO SPECCHIO RISCALDATO (SOLO VETRO) MIRROR GLASS HEATED</p> <p>COS.PEL. ref. 506.38100 SIMILAR ref. 500371327 DX-SX RH-LH</p>

	<p>VETRO SPECCHIO GRANDANGOLO (SOLO VETRO) MIRROR GLASS WIDE ANGLE</p> <p>COS.PEL. ref. SIMILAR ref. 506.38101 2997613 / 500371329</p>
	<p>VISIERA CON STAFFE SUN VISOR WITH BRACKET KIT</p> <p>COS.PEL. ref. SIMILAR ref. 706.39100 2994472 / 2997108</p>
	<p>RIVESTIMENTO SOTTOMOTORE S.M.C. - GRIGIO ENGINE PROTECTION S.M.C. - GREY</p> <p>COS.PEL. ref. SIMILAR ref. 806.27275 500327275 / 500348517</p>
	<p>SUPPORTO PARAURTI METALLO BUMPER BRACKET STEEL</p> <p>COS.PEL. ref. SIMILAR ref. 1006.34400 500337600 DX RH</p> <p>1006.34401 500333817 SX LH</p>
	<p>PANNELLO PORTA DOOR PANEL</p> <p>COS.PEL. ref. SIMILAR ref. 1406.38004 500339322 DX RH</p> <p>1406.38005 500339321 SX LH</p>
 	<p>INDICATORE DIREZIONE DIRECTION INDICATOR</p> <p>COS.PEL. ref. SIMILAR ref. 1606.35914 500320425 / 500320427 DX RH</p> <p>1606.35915 500320426 / 500320428 SX LH</p>
 	<p>FANALINO CORNER LAMP</p> <p>COS.PEL. ref. SIMILAR ref. 1606.35916 504104467 DX RH</p> <p>1606.35917 504104465 SX LH</p>
 	<p>FANALE LATERALE SIDE LAMP</p> <p>COS.PEL. ref. SIMILAR ref. 1606.35920 500328136 DX RH</p> <p>1606.35921 500328137 SX LH</p>

 	<p>FANALE LATERALE SIDE LAMP</p> <p>COS.PEL. ref. SIMILAR ref. 1606.35922 500355252</p> <p>1606.35923 500355253</p> <p style="text-align: right;">DX RH</p> <p style="text-align: right;">SX LH</p>
 	<p>FANALE LATERALE SIDE LAMP</p> <p>COS.PEL. ref. SIMILAR ref. 1606.35924 504104575</p> <p>1606.35925 504104577</p> <p style="text-align: right;">DX RH</p> <p style="text-align: right;">SX LH</p>
 	<p>FANALE LATERALE SIDE LAMP</p> <p>COS.PEL. ref. SIMILAR ref. 1606.35926 504104580</p> <p>1606.35927 504104582</p> <p style="text-align: right;">DX RH</p> <p style="text-align: right;">SX LH</p>
 	<p>FANALE INGOMBRO CABINA SIDE MARKER</p> <p>COS.PEL. ref. SIMILAR ref. 1606.35928 500316961</p> <p>1606.35929 500316960</p> <p style="text-align: right;">DX RH</p> <p style="text-align: right;">SX LH</p>
 	<p>PROIETTORE H1 H7 - PREDISPOSTO PER CORRETTORE ASSETTO HEADLAMP H1 H7 - SUITABLE FOR LOAD LEVEL ADJUSTMENT</p> <p>COS.PEL. ref. SIMILAR ref. 1606.35012 500307754</p> <p>1606.35013 500307755</p> <p style="text-align: right;">DX RH</p> <p style="text-align: right;">SX LH</p>
	<p>MANIGLIA PORTA LATERALE SCORREVOLE NERO - SENZA CHIAVE DOOR HANDLE SLIDING DOOR BLACK - WITHOUT KEY</p> <p>COS.PEL. ref. SIMILAR ref. 1706.38119 500329761</p> <p style="text-align: right;">DX RH</p>
	<p>MANIGLIA PORTA NERO - SENZA CHIAVE DOOR HANDLE BLACK - WITHOUT KEY</p> <p>COS.PEL. ref. SIMILAR ref. 1706.38120 99489590</p> <p>1706.38121 99489589</p> <p style="text-align: right;">DX RH</p> <p style="text-align: right;">SX LH</p>
	<p>MANIGLIA PORTA INTERNA INNER DOOR HANDLE</p> <p>COS.PEL. ref. SIMILAR ref. 1706.38122 500314228</p> <p>1706.38123 500314227</p> <p style="text-align: right;">DX RH</p> <p style="text-align: right;">SX LH</p>

	<p>GUARNIZIONE PARABREZZA WINDSCREEN GASKET</p> <p>COS.PEL. ref. SIMILAR ref. 1801.36000 504021635 / 97169308</p>
	<p>GUARNIZIONE GIROPORTA lunghezza 4,45 m HOOD WEATHERSTRIP 4,45 m</p> <p>COS.PEL. ref. SIMILAR ref. 1806.36001 504203320 / 504364956</p>
	<p>ALZACRISTALLI ELETTRICO - CON MOTORINO - 2 PIN + CAVO WINDOW REGULATOR ELECTRIC - WITH MOTOR - 2 PIN + CABLE</p> <p>COS.PEL. ref. SIMILAR ref.</p> <p>1906.20010 500314230 / 504053528 / 504173866 DX RH</p> <p>1906.20011 500314229 / 504053527 / 504173868 SX LH</p>
	<p>PROTEZIONE FARO Per Cos.Ive Daily 2000 GRID For Cos.Ive Daily 2000</p> <p>COS.PEL. ref. SIMILAR ref. 2000.00011 -</p>
	<p>FANALE POSTERIORE 5 FUNZIONI REAR-LIGHT 5 FUNCTIONS</p> <p>COS.PEL. ref. SIMILAR ref.</p> <p>008590 500356782 Relativo connettore 003120</p> <p>008600 500356783 Relativo connettore 003120</p> <p>TRASPARENTE / LENS</p> <p>012621 42471138 / 7984015 DX RH</p> <p>012721 42471137 / 7984016 SX LH</p>
 	<p>FANALE POSTERIORE SENZA PORTALAMPADA REAR-LIGHT WITHOUT LAMPHOLDER</p> <p>COS.PEL. ref. SIMILAR ref.</p> <p>1606.35930 500319558 DX RH</p> <p>1606.35931 500319559 SX LH</p> <p>TRASPARENTE / LENS</p>

Daily 2006



	<p>COFANO METALLO HOOD STEEL</p> <p>COS.PEL. ref. SIMILAR ref. 106.39140 3800056</p>
	<p>FRONTALE METALLO FRONT PANEL STEEL</p> <p>COS.PEL. ref. SIMILAR ref. 106.39141 3800059</p>
	<p>GRIGLIA FRONTALE A.B.S. FRONT GRILLE A.B.S.</p> <p>COS.PEL. ref. SIMILAR ref. 106.39144 3802803 / 3802804</p>
	<p>GRIGLIA FRONTALE DAILY 2006 BUS FRONT GRILLE DAILY 2006 BUS</p> <p>COS.PEL. ref. SIMILAR ref. 106.39145 5801255767</p>
	<p>PARAFANGO ANTERIORE METALLO FRONT MUDGUARD STEEL</p> <p>COS.PEL. ref. SIMILAR ref. 206.39100 3800001 / 5801352978 DX RH</p> <p>206.39101 3800002 / 5801352974 SX LH</p>

	<p>RIPARO PARAFANGO P.P. PROTECTION MUDGUARD P.P.</p> <p>COS.PEL. ref. SIMILAR ref. 206.39102 3802038</p> <p>206.39103 3802037</p> <p style="text-align: right;">DX RH</p> <p style="text-align: right;">SX LH</p>
	<p>CANTONALE PARAURTI POSTERIORE P.P. - NERO REAR CORNER BUMPER P.P. - BLACK</p> <p>COS.PEL. ref. SIMILAR ref. 406.33922 504099511</p> <p>406.33923 504099512</p> <p style="text-align: right;">DX RH</p> <p style="text-align: right;">SX LH</p>
	<p>PARAURTI ANTERIORE CON PRIMER P.P. - PRIMER FRONT BUMPER P.P. - PRIMER</p> <p>COS.PEL. ref. SIMILAR ref. 406.39189 3802743 / 5801255055</p>
	<p>PARAURTI ANTERIORE P.P. - NERO FRONT BUMPER P.P. - BLACK</p> <p>COS.PEL. ref. SIMILAR ref. 406.39190 3802001 / 5801255053</p>
<p>AD ESAURIMENTO SCORTE UNTIL SELL-OUT</p> 	<p>PARAURTI CENTRALE 4X4 METALLO - NERO FRONT BUMPER 4X4 STEEL - BLACK</p> <p>COS.PEL. ref. SIMILAR ref. 406.39191 504245477</p>
<p>AD ESAURIMENTO SCORTE UNTIL SELL-OUT</p> 	<p>ANGOLO PARAURTI 4X4 METALLO CORNER BUMPER STEEL</p> <p>COS.PEL. ref. SIMILAR ref. 406.39192 504245479</p> <p>406.39193 504245478</p> <p style="text-align: right;">DX RH</p> <p style="text-align: right;">SX LH</p>
 <p style="text-align: center;">cm 180</p>	<p>BARRA PARAINCASTRO METALLO - NERA REAR BUMPER STEEL - BLACK</p> <p>COS.PEL. ref. SIMILAR ref. 400.02000 500326870</p> <p style="text-align: right;">Cassoni fino a 2000 mm</p>
 <p style="text-align: center;">cm 180</p>	<p>BARRA PARAINCASTRO METALLO - GRIGIA REAR BUMPER STEEL - GREY</p> <p>COS.PEL. ref. SIMILAR ref. 400.02001 500332454</p> <p style="text-align: right;">Cassoni fino a 2000 mm</p>

	<p>SPECCHIO RETROVISORE BRACCIO CORTO - ELETTRICO - RISCALDATO REAR-VIEW MIRROR SHORT ARM - ELECTRIC - HEATED COS.PEL. ref. SIMILAR ref. 506.39496 5801367641 / 5801755754 DX RH</p> <p>506.39497 5801367608 / 5801755709 SX LH</p>
	<p>SPECCHIO RETROVISORE BRACCIO LUNGO - ELETTRICO - RISCALDATO REAR-VIEW MIRROR LONG ARM - ELECTRIC - HEATED COS.PEL. ref. SIMILAR ref. 506.39498 5801367568 / 5801736696 DX RH</p> <p>506.39499 5801367571 / 5801736705 / 5802032045 SX LH</p>
	<p>VETRO SPECCHIO RISCALDATO MIRROR GLASS HEATED COS.PEL. ref. SIMILAR ref. 506.39500 3801927 DX RH</p> <p>506.39501 3801926 SX LH</p>
	<p>VETRO SPECCHIO GRANDANGOLO - RISCALDATO - RAGGIO 300 MIRROR GLASS WIDE ANGLE - HEATED - RADIUS 300 COS.PEL. ref. SIMILAR ref. 506.39502 3801929 DX RH</p> <p>506.39503 3801928 SX LH</p>
	<p>VISIERA CON STAFFE SUN VISOR WITH BRACKET KIT COS.PEL. ref. SIMILAR ref. 706.39100 2994472 / 2997108</p>
 	<p>FANALINO SU SPECCHIETTO SIDE LAMP COS.PEL. ref. SIMILAR ref. 1606.39202 3801915 DX RH</p> <p>1606.39203 3801914 SX LH</p>
 	<p>PROIETTORE H1 H1 H7 - PREDISPOSTO PER CORRETTORE ASSETTO HEADLAMP H1 H1 H7 - SUITABLE FOR LOAD LEVEL ADJUSTEMENT COS.PEL. ref. SIMILAR ref. 1606.39200 69500010 DX RH</p> <p>1606.39201 69500013 SX LH</p>
	<p>GUARNIZIONE GIROPORTA lunghezza 4,45 m HOOD WEATHERSTRIP 4,45 m COS.PEL. ref. SIMILAR ref. 1806.36001 504203320 / 504364956</p>

	<p>ALZACRISTALLI ELETTRICO COMFORT ELETTRICO - CON MOTORINO - 6 PIN WINDOW REGULATOR COMFORT ELECTRIC - WITH MOTOR - 6 PIN COS.PEL. ref. SIMILAR ref. 1906.39000 42574135 / 504356351 DX RH 1906.39001 42574134 / 504356352 SX LH</p>
	<p>KIT PER CONNESSIONI ELETTRICHE Connettore SUPERSEAL 2 vie femmina KIT FOR ELECTRICAL JOINTS Connector SUPERSEAL ways female COS.PEL. ref. SIMILAR ref. 003123 - Connettore per la serie 1500.xxxxx</p>
	<p>FANALE POSTERIORE REAR-LIGHT COS.PEL. ref. SIMILAR ref. 003950 5801351224 / 581631433 / 69500026 DX RH Relativo connettore 003120 003951 5801351218 / 581631438 / 69500032 SX LH Relativo connettore 003120 TRASPARENTE / LENS 013901 42555131 / 42555132 DX-SX RH-LH</p>
	<p>FANALE POSTERIORE REAR-LIGHT LED - 12V - Connettore posteriore AMP 1.5 LED - 12V - Rear connector AMP 1.5 COS.PEL. ref. SIMILAR ref. 1500.00004 - DX RH Relativo connettore multipolare 003120 1500.00005 - SX LH Relativo connettore multipolare 003120 TRASPARENTE / LENS</p>
	<p>FARO POSTERIORE REAR-LIGHT LED - 3 STOP LED - 3 STOP COS.PEL. ref. SIMILAR ref. 1506.39002 69500805 TRASPARENTE / LENS</p>
	<p>FARO POSTERIORE REAR-LIGHT LED - 3 STOP CON LUCE DI CORTESIA LED - 3 STOP COS.PEL. ref. SIMILAR ref. 1506.39003 69500806 TRASPARENTE / LENS</p>



	<p>GRIGLIA GRILLE</p> <p>COS.PEL. ref. SIMILAR ref. 106.41100 5801342732</p>
	<p>PARAFANGO ANTERIORE METALLO FRONT MUDGUARD STEEL</p> <p>COS.PEL. ref. SIMILAR ref. 206.39100 3800001 / 5801352978 DX RH</p> <p>206.39101 3800002 / 5801352974 SX LH</p>
	<p>CANTONALE PARAURTI POSTERIORE P.P. - NERO REAR CORNER BUMPER P.P. - BLACK</p> <p>COS.PEL. ref. SIMILAR ref. 406.33922 504099511 DX RH</p> <p>406.33923 504099512 SX LH</p>
	<p>PARAURTI SENZA FORI FENDI FRONT BUMPER W/O HOLES</p> <p>COS.PEL. ref. SIMILAR ref. 406.41090 5801350675</p>
	<p>PARAURTI CON FORI FENDI FRONT BUMPER WITH HOLES</p> <p>COS.PEL. ref. SIMILAR ref. 406.41091 5801362619</p>

	<p>TAPPO PARAURTI SUP. COVER BUMPER</p> <p>COS.PEL. ref. SIMILAR ref. 406.41092 5801362626 DX RH</p> <p>406.41093 5801350677 SX LH</p>
	<p>TAPPO PARAURTI INF. COVER BUMPER</p> <p>COS.PEL. ref. SIMILAR ref. 406.41094 5801362625 DX RH</p> <p>406.41095 5801350681 SX LH</p>
	<p>RIVESTIMENTO PARAURTI SUPERIORE UPPER FRONT BUMPER COVER</p> <p>COS.PEL. ref. SIMILAR ref. 406.41096 5801339946 DX RH</p> <p>406.41097 5801339976 SX LH</p>
 	<p>FENDINEBBIA FOG LAMP</p> <p>COS.PEL. ref. SIMILAR ref. 1606.41032 5801377880 DX RH</p> <p>1606.41033 5801377881 SX LH</p>
 	<p>PROIETTORE H7 H1 W21 5W PY21W HEADLAMP H7 H1 W21 5W PY21W COS.PEL. ref. SIMILAR ref. 1606.41034 5801375415 DX RH</p> <p>1606.41035 5801375416 SX LH</p>
	<p>KIT PER CONNESSIONI ELETTRICHE Connettore SUPERSEAL 2 vie femmina KIT FOR ELECTRICAL JOINTS Connector SUPERSEAL ways female</p> <p>COS.PEL. ref. SIMILAR ref. 003123 -</p> <p>Connettore per la serie 1500.xxxxx</p>
 <p>cm 15,2</p>	<p>FANALE POSTERIORE REAR-LIGHT LED - 12V - Connettore posteriore AMP 1.5 LED - 12V - Rear connector AMP 1.5</p> <p>COS.PEL. ref. SIMILAR ref. 1500.00004 -</p> <p>1500.00005 -</p> <p>Relativo connettore multipolare 003120 Relativo connettore multipolare 003120</p> <p>TRASPARENTE / LENS</p> <p>DX RH SX LH</p>
 	<p>FANALE POSTERIORE REAR-LIGHT</p> <p>COS.PEL. ref. SIMILAR ref. 1606.41030 69500590 DX RH</p> <p>1606.41031 69500591 SX LH</p> <p>TRASPARENTE / LENS</p>



	<p>COFANO METALLO HOOD STEEL STEEL</p> <p>COS.PEL. ref. SIMILAR ref. 106.40100 5801492603</p>
	<p>TRAVERSA ANTERIORE CON MOSTRINE A.B.S. FRONT PANEL A.B.S.</p> <p>COS.PEL. ref. SIMILAR ref. 106.40101 5801772693 / 5802341775</p>
	<p>GRIGLIA RADIATORE RADIATOR GRILLE</p> <p>COS.PEL. ref. SIMILAR ref. 106.40102 5801587018</p>
	<p>SUPPORTO FRONTALE METALLO FRONT PANEL STEEL</p> <p>COS.PEL. ref. SIMILAR ref. 106.40103 5801513863</p>
	<p>PARAFANGO Metallo - Nero FOOTSTEP MUDGUARD Steel - Black</p> <p>COS.PEL. ref. SIMILAR ref. 206.40150 5801513999 DX RH</p> <p>206.40151 5801513992 SX LH</p>

	<p>PASSARUOTA ANTERIORE P.P. FRONT WHEEL TRIM P.P.</p> <p>COS.PEL. ref. SIMILAR ref. 206.40152 5801863943</p> <p>206.40153 5801863940</p> <p style="text-align: right;">DX RH</p> <p style="text-align: right;">SX LH</p>
	<p>MOSTRINA PARAFANGO P.P. COVER CORNER LAMP LONG P.P.</p> <p>COS.PEL. ref. SIMILAR ref. 206.40154 5801847156</p> <p>206.40155 5801847150</p> <p style="text-align: right;">DX RH</p> <p style="text-align: right;">SX LH</p>
	<p>MOSTRINA TRAVERSA P.P. PLASTIQUE P.P.</p> <p>COS.PEL. ref. SIMILAR ref. 206.40156 5801847137</p> <p>206.40157 5801847132</p> <p style="text-align: right;">DX RH</p> <p style="text-align: right;">SX LH</p>
	<p>PASSARUOTA POSTERIORE P.P. REAR WHEEL TRIM P.P.</p> <p>COS.PEL. ref. SIMILAR ref. 206.40158 5801530202</p> <p style="text-align: right;">DX-SX RH-LH</p>
	<p>PARAURTI ANGOLARE POSTERIORE REAR CORNER BUMPER</p> <p>COS.PEL. ref. SIMILAR ref. 406.40100 5801541042</p> <p>406.40099 5801541041</p> <p style="text-align: right;">DX RH</p> <p style="text-align: right;">SX LH</p>
 <p>cm 161 cm 16 cm 47 cm 37,5 cm 47</p>	<p>PEDANA PARAURTI POSTERIORE REAR BUMPER STEP</p> <p>COS.PEL. ref. SIMILAR ref. 406.40101 5801627043 / 5801627396</p>
	<p>SUPPORTO PEDANA PARAURTI POSTERIORE REAR BUMPER STEP BRACKET</p> <p>COS.PEL. ref. SIMILAR ref. 406.40102 5801627054</p>
	<p>PARAURTI ANTERIORE P.P. FRONT BUMPER P.P.</p> <p>COS.PEL. ref. SIMILAR ref. 406.40090 5801529742 / 5801772690 / 5802510213</p>

	<p>GRIGLIA PARAURTI CENTRALE P.P. CENTRAL BUMPER GRILLE P.P.</p> <p>COS.PEL. ref. SIMILAR ref. 406.40091 5801605499</p>
	<p>TAPPO GRIGLIA PARAURTI P.P. COVER GRILLE BUMPER P.P.</p> <p>COS.PEL. ref. SIMILAR ref. 406.40094 5801629789 DX RH</p> <p>406.40093 5801629792 SX LH</p>
	<p>TAPPO PARAURTI SUPERIORE P.P. UPPER BUMPER COVER P.P.</p> <p>COS.PEL. ref. SIMILAR ref. 406.40096 5801582700 DX RH</p> <p>406.40095 5801582711 SX LH</p>
	<p>TAPPO PARAURTI INFERIORE P.P. LOWER COVER GRILLE BUMPER P.P.</p> <p>COS.PEL. ref. SIMILAR ref. 406.40098 5801630222 DX RH</p> <p>406.40097 5801603636 SX LH</p>
	<p>SPECCHIO RETROVISORE ELETTRICO - RISCALDATO - BRACCIO CORTO REAR-VIEW MIRROR ELECTRIC - HEATED - SHORT ARM</p> <p>COS.PEL. ref. SIMILAR ref. 506.40500 5801552553 / 5802028037 DX RH</p> <p>506.40501 5801552552 / 5802028036 SX LH</p>
 <p style="text-align: center;">cm 175</p>	<p>VISIERA CON STAFFE CON STAFFE SUN VISOR WITH BRACKETS WITH BRACKETS</p> <p>COS.PEL. ref. SIMILAR ref. 706.40100 500051520</p>
	<p>RIVESTIMENTO PORTA ANTERIORE FRONT DOOR MOULDING</p> <p>COS.PEL. ref. SIMILAR ref. 806.40000 5801808067 DX RH</p> <p>806.40001 5801808084 SX LH</p>
	<p>BATTICALCAGNO ROCKER PANEL</p> <p>COS.PEL. ref. SIMILAR ref. 806.40002 5801521532 DX RH</p> <p>806.40003 5801521533 SX LH</p>

	<p>RIVESTIMENTO LATERALE SIDE MOULDING</p> <p>COS.PEL. ref. SIMILAR ref. 806.40004 5801521540 DX RH</p> <p>806.40005 5801521541 SX LH</p>
	<p>RIVESTIMENTO PORTELLONE CENTRALE C/FORO LUCE MIDDLE DOOR MOULDING W/LAMP HOLE</p> <p>COS.PEL. ref. SIMILAR ref. 806.40006 5801565740 / 5801811471 DX RH</p> <p>806.40007 5801811189 SX LH</p>
	<p>RIVESTIMENTO LATERALE SIDE MOULDING</p> <p>COS.PEL. ref. SIMILAR ref. 806.40008 5801530197 / 5801811665 DX RH</p> <p>806.40009 5801530199 / 5801811680 SX LH</p>
	<p>RIVESTIMENTO LATERALE C/FORI LUCE SIDE MOULDING W/LAMP HOLES</p> <p>COS.PEL. ref. SIMILAR ref. 806.40010 5801565760 / 5801812254 DX-SX RH-LH</p>
	<p>RIVESTIMENTO PORTA POSTERIORE REAR DOOR MOULDING</p> <p>COS.PEL. ref. SIMILAR ref. 806.40012 5801540271 DX RH</p> <p>806.40011 5801540269 SX LH</p>
	<p>STAFFA PARAURTI BUMPER BRACKET</p> <p>COS.PEL. ref. SIMILAR ref. 1006.40100 5801630551 DX RH</p> <p>1006.40101 5801620745 SX LH</p>
	<p>STAFFA PARAURTI BUMPER BRACKET</p> <p>COS.PEL. ref. SIMILAR ref. 1006.40102 5801618728 DX RH</p> <p>1006.40103 5801618730 SX LH</p>
	<p>STAFFA PARAURTI BUMPER BRACKET</p> <p>COS.PEL. ref. SIMILAR ref. 1006.40104 5801618741 DX RH</p> <p>1006.40105 5801605084 SX LH</p>



	<p>STAFFA PARAFANGO MUDGUARD BRACKET</p> <p>COS.PEL. ref. SIMILAR ref. 1006.40106 5801512513</p> <p style="text-align: right;">DX-SX RH-LH</p>
	<p>STAFFA PARAFANGO MUDGUARD BRACKET</p> <p>COS.PEL. ref. SIMILAR ref. 1006.40108 5801513990</p> <p style="text-align: right;">DX RH</p> <p>1006.40107 5801512484</p> <p style="text-align: right;">SX LH</p>
	<p>STAFFA PARAFANGO MUDGUARD BRACKET</p> <p>COS.PEL. ref. SIMILAR ref. 1006.40109 5801549124</p> <p style="text-align: right;">DX-SX RH-LH</p>
	<p>CORNICE FARO CON FORO BUMPER FOGLAMP HEADLIGHT BEZEL WITH HOLE</p> <p>COS.PEL. ref. SIMILAR ref. 1106.40080 5801529858</p> <p style="text-align: right;">DX RH</p> <p>1106.40081 5801529859</p> <p style="text-align: right;">SX LH</p>
	<p>CORNICE FARO SENZA FORO SENZA FORO BUMPER FOGLAMP HEADLIGHT BEZEL WITHOUT HOLE</p> <p>COS.PEL. ref. SIMILAR ref. 1106.40082 5801562215</p> <p style="text-align: right;">DX RH</p> <p>1106.40083 5801562216</p> <p style="text-align: right;">SX LH</p>
 	<p>LUCE DIREZIONE SIGNAL LIGHT</p> <p>COS.PEL. ref. SIMILAR ref. 1606.40602 5801585151 / 5801874639</p> <p style="text-align: right;">DX RH</p> <p>1606.40603 5801585146 / 5801874640</p> <p style="text-align: right;">SX LH</p> <p style="font-size: small;">Relativo portalampada 1606.40611</p>
 	<p>LUCE DIREZIONE SIGNAL LIGHT</p> <p>COS.PEL. ref. SIMILAR ref. 1606.40608 5801823334</p> <p style="text-align: right;">DX RH</p> <p>1606.40607 5801823572</p> <p style="text-align: right;">SX LH</p>
 	<p>LUCE INGOMBRO DRIVER CAB. MARKER</p> <p>COS.PEL. ref. SIMILAR ref. 1606.40610 5801610735</p> <p style="text-align: right;">DX RH</p> <p>1606.40609 5801610737</p> <p style="text-align: right;">SX LH</p>

	<p>PORTALAMPADA LAMP BULB HOLDER</p> <p>COS.PEL. ref. SIMILAR ref. 1606.40611 -</p> <p>Per lampada / For lamp : 1606.40602 / 3</p>
	<p>PROIETTORE HEADLAMP H7 H1 W21W W5W H7 H1 W21W W5W COS.PEL. ref. SIMILAR ref. 1606.40600 5801473749 DX RH</p> <p>1606.40601 5801473750 SX LH</p>
	<p>FENDINEBBIA H11 FOG LAMP H11</p> <p>COS.PEL. ref. SIMILAR ref. 1606.40604 5801587021 DX-SX RH-LH</p> <p>Portalamпада con relativa lampada 012.H1109</p>
<p>AD ESAURIMENTO SCORTE IN THE SELL-OUT</p> 	<p>VASCHETTA ESPANSIONE EXPANSION TANK</p> <p>COS.PEL. ref. SIMILAR ref. 2106.40080 504359964</p>
	<p>DEFLETTORI LATERALI SIDEWINDOW DEFLECTORS</p> <p>COS.PEL. ref. SIMILAR ref. 3006.00001 -</p>
	<p>ANELLO COPRIMOZZO 6 FORI 6 HOLES RING WHEEL COVER 6 HOLES 6 HOLES</p> <p>COS.PEL. ref. SIMILAR ref. 2000.00203 5801804152</p> <p>Ordinabile solo per conf. di 2 pz. / Sold by package of 2 pcs.</p>
	<p>KIT PER CONNESSIONI ELETTRICHE Connettore SUPERSEAL 2 vie femmina KIT FOR ELECTRICAL JOINTS Connector SUPERSEAL ways female</p> <p>COS.PEL. ref. SIMILAR ref. 003123 -</p> <p>Connettore per la serie 1500.xxxxx</p>
	<p>FANALE POSTERIORE REAR-LIGHT LED - 12V - Connettore posteriore AMP 1.5 LED - 12V - Rear connector AMP 1.5</p> <p>COS.PEL. ref. SIMILAR ref. 1500.00004 - DX RH 1500.00005 - SX LH</p> <p>Relativo connettore multipolare 003120 Relativo connettore multipolare 003120 TRASPARENTE / LENS</p>





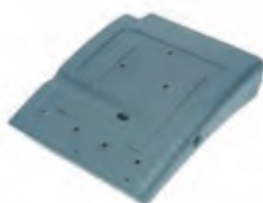

Daily 2014







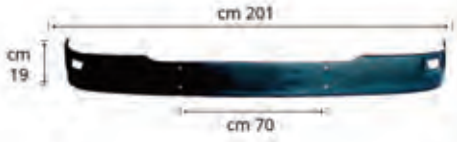

	<p>FANALE POSTERIORE REAR-LIGHT 3o Stop Base S2014 - LED 3o STOP - LED</p> <p>COS.PEL. ref. SIMILAR ref. 1506.40601 5801557592</p> <p>TRASPARENTE / LENS</p>
	<p>FANALE POSTERIORE REAR-LIGHT 3o Stop Medio S2014 - LED - CON LUCE DI CORTESIA 3o STOP - LED</p> <p>COS.PEL. ref. SIMILAR ref. 1506.40602 5801557593</p> <p>TRASPARENTE / LENS</p>
 	<p>FANALE POSTERIORE REAR-LIGHT</p> <p>COS.PEL. ref. SIMILAR ref. 1606.40606 5801523221</p> <p>1606.40605 5801523220</p> <p>TRASPARENTE / LENS</p> <p style="text-align: right;">DX RH SX LH</p>

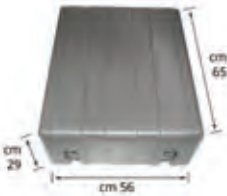

<p>AD ESAURIMENTO SCORTE IN THE SELL-GOVT</p> 	<p>GRIGLIA S.M.C. - GRIGIO GRILLE S.M.C. - GREY</p> <p>COS.PEL. ref. SIMILAR ref. 106.02002 504110983 / 8142413</p>
	<p>PEDANA PARAFANGO S.M.C. - GRIGIO CHIARO MUDGUARD FOOTSTEP S.M.C. - LIGHT GREY</p> <p>COS.PEL. ref. SIMILAR ref. 206.02000 8142603 DX RH</p> <p>206.01999 8142604 SX LH</p> <p>Griglia/Grille : 1006.00008 Griglia/Grille : 1006.00008</p>
	<p>PEDANA PARAFANGO S.M.C. - GRIGIO SCURO MUDGUARD FOOTSTEP S.M.C. - DARK GREY</p> <p>COS.PEL. ref. SIMILAR ref. 206.17944 500317944 / 500317946 DX RH</p> <p>206.17945 500317945 / 500317947 SX LH</p> <p>Griglia/Grille : 1006.00008 Griglia/Grille : 1006.00008</p>
	<p>RIPAROFANGO POSTERIORE R.T.M. - GRIGIO SCURO REAR MUDGUARD R.T.M. - DARK GREY</p> <p>COS.PEL. ref. SIMILAR ref. 206.18340 500318341 DX RH</p> <p>206.18341 500318345 SX LH</p>
	<p>RIPAROFANGO POSTERIORE R.T.M. - GRIGIO CHIARO REAR MUDGUARD R.T.M. - LIGHT GREY</p> <p>COS.PEL. ref. SIMILAR ref. 206.18342 8142621 DX RH</p> <p>206.18343 8142626 SX LH</p>

Eurocargo 60

	<p>SUPPORTO PEDANA PARAFANGO S.M.C. FOOTSTEP MUDGUARD BRACKET S.M.C.</p> <p>COS.PEL. ref. SIMILAR ref. 206.42842 8142842</p> <p>206.42843 98456508</p> <p style="text-align: right;">DX RH</p> <p style="text-align: right;">SX LH</p>
	<p>PARAURTI ANTERIORE P.P.F.V. - GRIGIO CHIARO FRONT BUMPER P.P.F.V. - LIGHT GREY</p> <p>COS.PEL. ref. SIMILAR ref. 406.02000 2997103 / 8142590</p>
	<p>PARAURTI ANTERIORE P.P.F.V. - GRIGIO SCURO FRONT BUMPER P.P.F.V. - DARK GREY</p> <p>COS.PEL. ref. SIMILAR ref. 406.16865 2997106 / 500316865</p>
	<p>TAPPO PARAURTI GRIGIO CHIARO GRIGIO CHIARO COVER BUMPER LIGHT GREY</p> <p>COS.PEL. ref. SIMILAR ref. 406.02001 98464670</p>
	<p>TAPPO PARAURTI GRIGIO SCURO GRIGIO SCURO COVER BUMPER DARK GREY</p> <p>COS.PEL. ref. SIMILAR ref. 406.43034 98473849</p>
	<p>SPECCHIO RETROVISORE REAR-VIEW MIRROR</p> <p>COS.PEL. ref. SIMILAR ref. 506.33000 98424105</p> <p style="text-align: right;">DX-SX RH-LH</p>
	<p>VISIERA EUROCARGO SENZA STAFFE SENZA STAFFE SUN VISOR WITHOUT BRACKET KIT WITHOUT BRACKET KIT</p> <p>COS.PEL. ref. SIMILAR ref. 706.60201 1908138</p> <p style="text-align: right;">Relativo kit staffe 1006.60200</p>
	<p>MONTANTE PARABREZZA WINDSHIELD UPRIGHT</p> <p>COS.PEL. ref. SIMILAR ref. 906.75282 504027559 / 504116084</p> <p>906.75283 504027560 / 504116083</p> <p style="text-align: right;">DX RH</p> <p style="text-align: right;">SX LH</p>





	<p>GRIGLIA PEDANA ALLUMINIO FOOTSTEP GRILLE ALUMINIUM</p> <p>COS.PEL. ref. SIMILAR ref. 1006.00008 3798586 / 8142607</p> <p style="text-align: right;">DX-SX RH-LH</p>
	<p>FORCELLA ALZACRISTALLI WINDOW REGULATOR CLIP</p> <p>COS.PEL. ref. SIMILAR ref. 1006.60029 2997187 / 98416236</p>
	<p>COPRI BATTERIA P.P. BATTERY COVER P.P.</p> <p>COS.PEL. ref. SIMILAR ref. 1006.90106 98474429</p>
	<p>DOPPIA VITE METALLO SCREW STEEL</p> <p>COS.PEL. ref. SIMILAR ref. 3000.02005 98437200</p>
	<p>CANTONALE S.M.C. CORNER PANEL S.M.C.</p> <p>COS.PEL. ref. SIMILAR ref. 1206.43812 8143812</p> <p style="text-align: right;">DX RH</p> <p>1206.43813 8143813</p> <p style="text-align: right;">SX LH</p> <p style="text-align: center;">Fornito grezzo</p>
	<p>SOTTOPORTA METALLO UNDER DOOR STEEL</p> <p>COS.PEL. ref. SIMILAR ref. 1406.60060 -</p> <p style="text-align: right;">DX RH</p> <p>1406.60061 -</p> <p style="text-align: right;">SX LH</p>
 	<p>LUCE DIREZIONALE CORNER LAMP</p> <p>COS.PEL. ref. SIMILAR ref. 1606.75916 500340695</p> <p style="text-align: right;">DX RH</p> <p>1606.75917 500340696</p> <p style="text-align: right;">SX LH</p>
 	<p>FANALINO LATERALE SIDE LAMP</p> <p>COS.PEL. ref. SIMILAR ref. 1606.75918 4862220</p> <p style="text-align: right;">DX-SX RH-LH</p>

Eurocargo 60

 	<p>FANALINO LATERALE SIDE LAMP</p> <p>COS.PEL. ref. SIMILAR ref. 1606.75919 99452662</p> <p style="text-align: right;">DX-SX RH-LH</p>
 	<p>FANALINO VISIERA NERO - 91 -> SUN VISOR'S MARKER BLACK - 91 -></p> <p>COS.PEL. ref. SIMILAR ref. 1606.75920 500314717</p> <p style="text-align: right;">DX RH</p> <p>1606.75921 500314716 SX LH</p>
 	<p>FANALINO VISIERA ARGENTO - 91 -> SUN VISOR'S MARKER SILVER - 91 -></p> <p>COS.PEL. ref. SIMILAR ref. 1606.75922 98461649</p> <p style="text-align: right;">DX RH</p> <p>1606.75923 98461648 SX LH</p>
 	<p>FENDINEBBIA H3 FOG LAMP H3</p> <p>COS.PEL. ref. SIMILAR ref. 1606.60110 98437475</p> <p style="text-align: right;">DX RH</p> <p>1606.60111 98437476 SX LH</p>
 	<p>PROIETTORE H4 - PREDISPOSTO PER CORRETTORE ASSETTO HEADLAMP H4 - SUITABLE FOR LOAD LEVEL ADJUSTMENT</p> <p>COS.PEL. ref. SIMILAR ref. 1606.75122 500340361</p> <p style="text-align: right;">DX RH</p> <p>1606.75121 500340408 SX LH</p>
 	<p>PROIETTORE H4 - CORRETTORE ASSETTO MANUALE HEADLAMP H4 - MANUAL LOAD LEVEL ADJUSTMENT</p> <p>COS.PEL. ref. SIMILAR ref. 1606.75200 500340503</p> <p style="text-align: right;">DX RH</p> <p>1606.75201 500340543 SX LH</p>
	<p>MANIGLIA PORTA NERO - CON CHIAVE DOOR HANDLE BLACK - WITH KEY</p> <p>COS.PEL. ref. SIMILAR ref. 1706.60900 98404709</p> <p style="text-align: right;">DX RH</p> <p>1706.60901 98404710 SX LH</p>
	<p>KIT MANIGLIE PORTE NERO - CON CHIAVI DOOR HANDLE KIT BLACK - WITH KEYS</p> <p>COS.PEL. ref. SIMILAR ref. 1706.60902 500335296 / 98404714</p> <p style="text-align: right;">DX-SX RH-LH</p>

	<p>MANIGLIA PORTA INTERNA FRONT DOOR HANDLE INSIDE</p> <p>COS.PEL. ref. SIMILAR ref. 1706.60904 98463024 DX RH</p> <p>1706.60903 98463023 SX LH</p>
	<p>SERRATURA PORTA ELETTRICA ELECTRIC DOOR LOCK</p> <p>COS.PEL. ref. SIMILAR ref. 1706.60906 98411951 / 98416419 DX RH</p> <p>1706.60905 98411952 / 98416424 SX LH</p>
	<p>ARRESTO PORTA DOOR STOP</p> <p>COS.PEL. ref. SIMILAR ref. 1706.60908 5802132946 / 99476267 DX RH</p> <p>1706.60907 5802132944 / 99476268 SX LH</p>
	<p>GUARNIZIONE PARABREZZA WINDSCREEN GASKET</p> <p>COS.PEL. ref. SIMILAR ref. 1806.60120 8143851</p>
	<p>RASCHIAVETRO ESTERNO GLASS GUIDE WEATHER STRIP</p> <p>COS.PEL. ref. SIMILAR ref. 1806.60122 8142800 DX RH</p> <p>1806.60121 8142799 SX LH</p>
	<p>RASCHIAVETRO INTERNO GLASS GUIDE WEATHER STRIP</p> <p>COS.PEL. ref. SIMILAR ref. 1806.60124 98408394 DX RH</p> <p>1806.60123 98408393 SX LH</p>
	<p>GUARNIZIONE GIROVETRO SX UPPER FRAME WEATHER STRIP</p> <p>COS.PEL. ref. SIMILAR ref. 1806.60126 8142802 DX RH</p> <p>1806.60125 8142801 SX LH</p>
	<p>GUARNIZIONE VETRO FISSO GLASS RUBBER SEAL</p> <p>COS.PEL. ref. SIMILAR ref. 1806.60128 98409362 DX RH</p> <p>1806.60127 98409363 SX LH</p>





Eurocargo 60

	<p>TRAFILATO PSL VANO PORTA ROTOLO MT. 25 DOOR OPENING WEATHER STRIP ROLLS MT. 25</p> <p>COS.PEL. ref. SIMILAR ref. 1806.60131 99477139</p>
	<p>TRAFILATO PSL VANO PORTA SPEZZONE MT. 4,5 DOOR OPENING WEATHER STRIP PIECE LINGHT MT.4,5</p> <p>COS.PEL. ref. SIMILAR ref. 1806.60132 8142404</p>
	<p>GUIDA VETRO WINDOW FRAME</p> <p>COS.PEL. ref. SIMILAR ref. 1806.60134 98484152 DX RH</p> <p>1806.60133 98404902 SX LH</p>
	<p>ALZACRISTALLI MANUALE WINDOW REGULATOR MANUAL</p> <p>COS.PEL. ref. SIMILAR ref. 1906.60030 2997185 / 98407741 DX RH</p> <p>1906.60031 2997186 / 98407744 SX LH</p>
	<p>ALZACRISTALLI ELETTRICO - CON MOTORINO - 2 PIN WINDOW REGULATOR ELECTRIC - WITH MOTOR - 2 PIN</p> <p>COS.PEL. ref. SIMILAR ref. 1906.60032 2997195 / 98407721 / 99487780 DX RH</p> <p>1906.60033 2997196 / 98407722 / 99487781 SX LH</p>
 <p>cm 14</p>	<p>TIRANTE COPRI BATTERIA CORTO 140 mm MUDGUARD TENSIONER SHORT 140 mm</p> <p>COS.PEL. ref. SIMILAR ref. 1006.90107 4605163</p>
 <p>cm 14,4</p>	<p>TIRANTE COPRI BATTERIA LUNGO 144 mm MUDGUARD TENSIONER LONG 144 mm</p> <p>COS.PEL. ref. SIMILAR ref. 1006.90109 4784894</p>
	<p>MOLLA A GAS Lunghezza [mm] 525 Corsa [mm] 220 Forza scarto [N] 600 GAS SPRING Lenght [mm] 525 Stroke [mm] 220 Waste force [N] 600</p> <p>COS.PEL. ref. SIMILAR ref. 2406.60100 500359930 / 98444263</p>

	<p>MOLLA A GAS Lunghezza [mm] 785 Corsa [mm] 350 Forza scarto [N] 230 GAS SPRING Lenght [mm] 785 Stroke [mm] 350 Waste force [N] 230</p> <p>COS.PEL. ref. SIMILAR ref. 2406.60101 500359924 / 98444262</p>
	<p>MOLLA A GAS Lunghezza [mm] 706 Corsa [mm] 300 Forza scarto [N] 200 GAS SPRING Lenght [mm] 706 Stroke [mm] 300 Waste force [N] 200</p> <p>COS.PEL. ref. SIMILAR ref. 2406.75100 504032792</p>
	<p>DEFLETTORI LATERALI CON CLIPS SIDEWINDOW DEFLECTORS WITH CLIPS</p> <p>COS.PEL. ref. SIMILAR ref. 3006.00000 -</p>
	<p>ANELLO COPRIMOZZO 8 FORI 8 FORI - PLASTICA / GRIGIO - DIAMETRO 22mm RING WHEEL COVER 8 HOLES 8 HOLES - PLASTIC - GREY - DIAMETER 22 mm</p> <p>COS.PEL. ref. SIMILAR ref. 2000.00206 500316950</p> <p>Ordinabile solo per conf. di 2 pz. / Sold by package of 2 pcs.</p>
	<p>FANALE POSTERIORE 5 FUNZIONI REAR-LIGHT 5 FUNCTIONS</p> <p>COS.PEL. ref. SIMILAR ref. 008550 500382617 / 98421202 DX RH</p> <p>008560 500382616 / 98421203 SX LH</p> <p>TRASPARENTE / LENS 012621 42471138 / 7984015 DX RH 012721 42471137 / 7984016 SX LH</p>

Eurocargo 120



<p>AD ESAURIMENTO SCORTE UNTIL STOCK OUT</p> 	<p>GRIGLIA S.M.C. - GRIGIO GRILLE S.M.C. - GREY</p> <p>COS.PEL. ref. SIMILAR ref. 106.02002 504110983 / 8142413</p>
	<p>PADANA PARAFANGO S.M.C. - GRIGIO SCURO MUDGUARD FOOTSTEP S.M.C. - DARK GREY</p> <p>COS.PEL. ref. SIMILAR ref. 206.17956 500317956 DX RH</p> <p>206.17957 500318079 SX LH</p> <p>Griglia/Grille : 1006.00004 inf - 1006.00008 sup Griglia/Grille : 1006.00004 inf - 1006.00008 sup</p>
	<p>PEDANA PARAFANGO S.M.C. - GRIGIO CHIARO MUDGUARD FOOTSTEP S.M.C. - LIGHT GREY</p> <p>COS.PEL. ref. SIMILAR ref. 206.17958 8142605 DX RH</p> <p>206.17959 8142609 SX LH</p> <p>Griglia/Grille : 1006.00004 inf - 1006.00008 sup Griglia/Grille : 1006.00004 inf - 1006.00008 sup.</p>
	<p>RIPAROFANGO POSTERIORE S.M.C. - GRIGIO CHIARO REAR MUDGUARD S.M.C. - LIGHT GREY</p> <p>COS.PEL. ref. SIMILAR ref. 206.18336 8142630 DX RH</p> <p>206.18337 8142629 SX LH</p>
	<p>RIPAROFANGO POSTERIORE S.M.C. - GRIGIO SCURO REAR MUDGUARD S.M.C. - DARK GREY</p> <p>COS.PEL. ref. SIMILAR ref. 206.18338 500318338 DX RH</p> <p>206.18339 500318289 / 500318293 SX LH</p>

	<p>SUPPORTO PEDANA PARAFANGO S.M.C. FOOTSTEP MUDGUARD BRACKET S.M.C.</p> <p>COS.PEL. ref. SIMILAR ref. 206.42483 8142843</p> <p style="text-align: right;">DX-SX RH-LH</p>
	<p>PEDANA S.M.C. - GRIGIO SCURO FOOTSTEP S.M.C. - DARK GREY</p> <p>COS.PEL. ref. SIMILAR ref. 306.42644 500318241</p> <p style="text-align: right;">DX RH</p> <p>306.42645 Griglia/Grille: 1006.00004 500318238 SX LH</p> <p style="text-align: right;">Griglia/Grille: 1006.00004</p>
 <p>cm 54,5</p>	<p>PARAURTI ANTERIORE P.P.G.F. - GRIGIO SCURO FRONT BUMPER P.P.G.F. - DARK GREY</p> <p>COS.PEL. ref. SIMILAR ref. 406.17137 500042694 / 500317137</p>
 <p>cm 54,5</p>	<p>PARAURTI ANTERIORE P.P.G.F. - GRIGIO CHIARO FRONT BUMPER P.P.G.F. - LIGHT GREY</p> <p>COS.PEL. ref. SIMILAR ref. 406.17138 500042693 / 8142601</p>
 <p>cm 201</p> <p>cm 19</p> <p>cm 70</p>	<p>VISIERA EUROCARGO SENZA STAFFE SENZA STAFFE SUN VISOR WITHOUT BRACKET KIT WITHOUT BRACKET KIT</p> <p>COS.PEL. ref. SIMILAR ref. 706.60201 1908138</p> <p style="text-align: right;">Relativo kit staffe 1006.60200</p>
	<p>MONTANTE PARABREZZA WINDSHIELD UPRIGHT</p> <p>COS.PEL. ref. SIMILAR ref. 906.75282 504027559 / 504116084 DX RH</p> <p>906.75283 504027560 / 504116083 SX LH</p>
	<p>GRIGLIA PEDANA INFERIORE ALLUMINIO LOWER FOOTSTEP GRILLE ALUMINIUM</p> <p>COS.PEL. ref. SIMILAR ref. 1006.00004 3798584 / 8142611 DX-SX RH-LH</p>
	<p>GRIGLIA PEDANA ALLUMINIO FOOTSTEP GRILLE ALUMINIUM</p> <p>COS.PEL. ref. SIMILAR ref. 1006.00008 3798586 / 8142607 DX-SX RH-LH</p>





Eurocargo 120

 	<p>LUCE DIREZIONALE CORNER LAMP</p> <p>COS.PEL. ref. SIMILAR ref. 1606.75916 500340695 DX RH</p> <p>1606.75917 500340696 SX LH</p>
 	<p>FANALINO LATERALE SIDE LAMP</p> <p>COS.PEL. ref. SIMILAR ref. 1606.75918 4862220 DX-SX RH-LH</p>
 	<p>FANALINO LATERALE SIDE LAMP</p> <p>COS.PEL. ref. SIMILAR ref. 1606.75919 99452662 DX-SX RH-LH</p>
 	<p>FANALINO VISIERA NERO - 91 -> SUN VISOR'S MARKER BLACK - 91 -></p> <p>COS.PEL. ref. SIMILAR ref. 1606.75920 500314717 DX RH</p> <p>1606.75921 500314716 SX LH</p>
 	<p>FANALINO VISIERA ARGENTO - 91 -> SUN VISOR'S MARKER SILVER - 91 -></p> <p>COS.PEL. ref. SIMILAR ref. 1606.75922 98461649 DX RH</p> <p>1606.75923 98461648 SX LH</p>
 	<p>FENDINEBBIA H3 FOG LAMP H3</p> <p>COS.PEL. ref. SIMILAR ref. 1606.60110 98437475 DX RH</p> <p>1606.60111 98437476 SX LH</p>
 	<p>PROIETTORE H4 - PREDISPOSTO PER CORRETTORE ASSETTO HEADLAMP H4 - SUITABLE FOR LOAD LEVEL ADJUSTMENT</p> <p>COS.PEL. ref. SIMILAR ref. 1606.75122 500340361 DX RH</p> <p>1606.75121 500340408 SX LH</p>
 	<p>PROIETTORE H4 - CORRETTORE ASSETTO MANUALE HEADLAMP H4 - MANUAL LOAD LEVEL ADJUSTMENT</p> <p>COS.PEL. ref. SIMILAR ref. 1606.75200 500340503 DX RH</p> <p>1606.75201 500340543 SX LH</p>

	<p>MANIGLIA PORTA INTERNA FRONT DOOR HANDLE INSIDE</p> <p>COS.PEL. ref. SIMILAR ref. 1706.60904 98463024 DX RH</p> <p>1706.60903 98463023 SX LH</p>
	<p>SERRATURA PORTA ELETTRICA ELECTRIC DOOR LOCK</p> <p>COS.PEL. ref. SIMILAR ref. 1706.60906 98411951 / 98416419 DX RH</p> <p>1706.60905 98411952 / 98416424 SX LH</p>
	<p>ARRESTO PORTA DOOR STOP</p> <p>COS.PEL. ref. SIMILAR ref. 1706.60908 5802132946 / 99476267 DX RH</p> <p>1706.60907 5802132944 / 99476268 SX LH</p>
	<p>GUIDA VETRO WINDOW FRAME</p> <p>COS.PEL. ref. SIMILAR ref. 1806.60134 98484152 DX RH</p> <p>1806.60133 98404902 SX LH</p>
 <p>cm 14</p>	<p>TIRANTE COPRI BATTERIA CORTO 140 mm MUDGUARD TENSIONER SHORT 140 mm</p> <p>COS.PEL. ref. SIMILAR ref. 1006.90107 4605163</p>
 <p>cm 14,4</p>	<p>TIRANTE COPRI BATTERIA LUNGO 144 mm MUDGUARD TENSIONER LONG 144 mm</p> <p>COS.PEL. ref. SIMILAR ref. 1006.90109 4784894</p>
	<p>MOLLA A GAS Lunghezza [mm] 706 Corsa [mm] 300 Forza scarto [N] 200 GAS SPRING Lenght [mm] 706 Stroke [mm] 300 Waste force [N] 200</p> <p>COS.PEL. ref. SIMILAR ref. 2406.75100 504032792</p>
 <p>cm 19</p>	<p>FANALE POSTERIORE 5 FUNZIONI REAR-LIGHT 5 FUNCTIONS</p> <p>COS.PEL. ref. SIMILAR ref. 008550 500382617 / 98421202 DX RH</p> <p>008560 500382616 / 98421203 SX LH</p> <p>TRASPARENTE / LENS 012621 42471138 / 7984015 DX RH</p> <p>012721 42471137 / 7984016 SX LH</p>







Eurocargo 150



<p>AD ESAURIMENTO SCORTE <small>UNTIL SELL-OUT</small></p> 	<p>GRIGLIA S.M.C. - GRIGIO GRILLE S.M.C. - GREY</p> <p>COS.PEL. ref. SIMILAR ref. 106.02002 504110983 / 8142413</p>
	<p>PEDANA PARAFANGO S.M.C. - GRIGIO SCURO FOOTSTEP MUDGUARD S.M.C. - DARK GREY</p> <p>COS.PEL. ref. SIMILAR ref. 206.15010 500317978 DX RH</p> <p>206.15011 Griglia/Grille: 1006.00005 500317979 SX LH</p> <p>Griglia/Grille: 1006.00005</p>
	<p>VASCHETTA PEDANA S.M.C. - GRIGIO SCURO FOOTSTEP S.M.C. - DARK GREY</p> <p>COS.PEL. ref. SIMILAR ref. 306.15030 500318230 / 8142616 DX RH</p> <p>306.15031 Griglia/Grille: 1006.00004 500318229 / 8142617 SX LH</p> <p>Griglia/Grille: 1006.00004</p>
<p>AD ESAURIMENTO SCORTE <small>UNTIL SELL-OUT</small></p> 	<p>PARAURTI ANTERIORE P.P.G.F. - GRIGIO CHIARO FRONT BUMPER P.P.G.F. - LIGHT GREY</p> <p>COS.PEL. ref. SIMILAR ref. 406.15089 500317145 / 8143221</p>
 <p>cm 66,5</p>	<p>PARAURTI ANTERIORE P.P.G.F. - GRIGIO SCURO FRONT BUMPER P.P.G.F. - DARK GREY</p> <p>COS.PEL. ref. SIMILAR ref. 406.15090 500317145</p>

 <p>cm 66,5</p>	<p>PARAURTI 150/180 FENDI APERTI P.P.G.F. - GRIGIO SCURO FRONT BUMPER P.P.G.F. - DARK GREY</p> <p>COS.PEL. ref. SIMILAR ref. 406.15091 500317145 / 8143221</p>
	<p>MONTANTE PARABREZZA WINDSHIELD UPRIGHT</p> <p>COS.PEL. ref. SIMILAR ref. 906.75282 504027559 / 504116084 DX RH</p> <p>906.75283 504027560 / 504116083 SX LH</p>
	<p>GRIGLIA PEDANA INFERIORE ALLUMINIO LOWER FOOTSTEP GRILLE ALUMINIUM</p> <p>COS.PEL. ref. SIMILAR ref. 1006.00004 3798584 / 8142611 DX-SX RH-LH</p>
	<p>GRIGLIA PEDANA CENTRALE ALLUMINIO CENTRE FOOTSTEP GRILLE ALUMINIUM</p> <p>COS.PEL. ref. SIMILAR ref. 1006.00005 3798585 / 8142610 DX-SX RH-LH</p>
	<p>CANTONALE S.M.C. CORNER PANEL S.M.C.</p> <p>COS.PEL. ref. SIMILAR ref. 1206.43812 8143812 DX RH</p> <p>1206.43813 8143813 SX LH</p> <p>Fornito grezzo</p>
 	<p>FANALINO LATERALE SIDE LAMP</p> <p>COS.PEL. ref. SIMILAR ref. 1606.75919 99452662 DX-SX RH-LH</p>
	<p>MANIGLIA PORTA INTERNA FRONT DOOR HANDLE INSIDE</p> <p>COS.PEL. ref. SIMILAR ref. 1706.60904 98463024 DX RH</p> <p>1706.60903 98463023 SX LH</p>
	<p>SERRATURA PORTA ELETTRICA ELECTRIC DOOR LOCK</p> <p>COS.PEL. ref. SIMILAR ref. 1706.60906 98411951 / 98416419 DX RH</p> <p>1706.60905 98411952 / 98416424 SX LH</p>

Eurocargo 150





	<p>ARRESTO PORTA DOOR STOP</p> <p>COS.PEL. ref. SIMILAR ref. 1706.60908 5802132946 / 99476267 DX RH</p> <p>1706.60907 5802132944 / 99476268 SX LH</p>
	<p>GUIDA VETRO WINDOW FRAME</p> <p>COS.PEL. ref. SIMILAR ref. 1806.60134 98484152 DX RH</p> <p>1806.60133 98404902 SX LH</p>
	<p>TIRANTE COPRI BATTERIA CORTO 140 mm MUDGUARD TENSIONER SHORT 140 mm</p> <p>COS.PEL. ref. SIMILAR ref. 1006.90107 4605163</p>
	<p>TIRANTE COPRI BATTERIA LUNGO 144 mm MUDGUARD TENSIONER LONG 144 mm</p> <p>COS.PEL. ref. SIMILAR ref. 1006.90109 4784894</p>
	<p>MOLLA A GAS Lunghezza [mm] 706 Corsa [mm] 300 Forza scarto [N] 200 GAS SPRING Lenght [mm] 706 Stroke [mm] 300 Waste force [N] 200</p> <p>COS.PEL. ref. SIMILAR ref. 2406.75100 504032792</p>
	<p>DEFLETTORI LATERALI CON CLIPS SIDELWINDOW DEFLECTORS WITH CLIPS</p> <p>COS.PEL. ref. SIMILAR ref. 3006.00000 -</p>
	<p>FANALE POSTERIORE 5 FUNZIONI REAR-LIGHT 5 FUNCTIONS</p> <p>COS.PEL. ref. SIMILAR ref. 008550 500382617 / 98421202 DX RH</p> <p>008560 500382616 / 98421203 SX LH</p> <p>TRASPARENTE / LENS 012621 42471138 / 7984015 DX RH 012721 42471137 / 7984016 SX LH</p>











<p>AD ESAURIMENTO SCORTE <small>(PARTI SELVAPART)</small></p> 	<p>GRIGLIA S.M.C. GRILLE S.M.C.</p> <p>COS.PEL. ref. SIMILAR ref. 106.75461 504027461</p>
	<p>PEDANA PARAFANGO CON ALETTA S.M.C. - GRIGIO FOOTSTEP MUDGUARD S.M.C. - GREY</p> <p>COS.PEL. ref. SIMILAR ref. 206.75120 504037735 / 504058445 DX RH</p> <p>206.75121 504037737 / 504058446 SX LH</p> <p>Griglia/Grille : 1006.18000 Griglia/Grille : 1006.18000</p>
	<p>PEDANA PARAFANGO SENZA ALETTA S.M.C. - GRIGIO FOOTSTEP MUDGUARD S.M.C. - GREY</p> <p>COS.PEL. ref. SIMILAR ref. 206.75124 504052236 / 504058447 DX RH</p> <p>206.75123 504052237 / 504058448 SX LH</p> <p>Griglia/Grille : 1006.18000 Griglia/Grille : 1006.18000</p>
	<p>RIPAROFANGO POSTERIORE S.M.C. - GRIGIO REAR MUDGUARD S.M.C. - GREY</p> <p>COS.PEL. ref. SIMILAR ref. 206.75300 504027536 / 504080951 DX RH</p> <p>206.75301 504027537 / 504080952 SX LH</p>
 <p>cm 46</p>	<p>PARAURTI ANTERIORE P.P.G.F. - GRIGIO FRONT BUMPER P.P.G.F. - GREY</p> <p>COS.PEL. ref. SIMILAR ref. 406.75090 2997370 / 42554000 / 504027613</p>









Eurocargo 75e13/120e21

 <p>cm 46</p>	<p>PARAURTI ANTERIORE CON FORI FENDI P.P.G.F. - GRIGIO FRONT BUMPER WHIT HOLES P.P.G.F. - GREY</p> <p>COS.PEL. ref. SIMILAR ref. 406.75091 2997638 / 504027614</p>
	<p>SPORTELLO PARAURTI BUMPER COVER</p> <p>COS.PEL. ref. SIMILAR ref. 406.75093 504043051 / 504043052 / 504102117</p>
	<p>COPERCHIO LATERALE SIDE COVER</p> <p>COS.PEL. ref. SIMILAR ref. 406.83944 500380095 / 504042188 DX RH</p> <p>406.83945 500380094 / 504042187 SX LH</p>
	<p>TAPPO PARAURTI A.B.S. COVER BUMPER A.B.S.</p> <p>COS.PEL. ref. SIMILAR ref. 406.70096 500380066 / 500383459 / 504042191 / 504258139 / 504284012</p>
 <p>cm 211</p> <p>cm 30</p> <p>cm 69,5</p>	<p>VISIERA TECTOR TETTO BASSO SENZA STAFFE SENZA STAFFE - CON FORI FANALINI SUN VISOR LOW CAB WITHOUT BRACKET KIT WITHOUT BRACKET KIT</p> <p>COS.PEL. ref. SIMILAR ref. 706.75300 504061726</p> <p>Relativo kit staffe 1006.75300</p>
	<p>CONVOGLIATORE ARIA A.B.S. AIR CONVEYOR A.B.S.</p> <p>COS.PEL. ref. SIMILAR ref. 906.75280 504060280 / 504116074 DX RH</p> <p>906.75281 504060281 / 504116073 SX LH</p>
	<p>MONTANTE PARABREZZA WINDSHIELD UPRIGHT</p> <p>COS.PEL. ref. SIMILAR ref. 906.75282 504027559 / 504116084 DX RH</p> <p>906.75283 504027560 / 504116083 SX LH</p>
	<p>GRIGLIA PEDANA PLASTICA FOOTSTEP GRILLE PLASTIC</p> <p>COS.PEL. ref. SIMILAR ref. 1006.18000 504043817 DX-SX RH-LH</p> <p>Per 206.75120-1 / 206.18011</p>

	<p>FORCELLA ALZACRISTALLI WINDOW REGULATOR CLIP</p> <p>COS.PEL. ref. SIMILAR ref. 1006.60029 2997187 / 98416236</p>
	<p>MOLLETTA DI FISSAGGIO CLIP FIXING</p> <p>COS.PEL. ref. SIMILAR ref. 1006.70100 500380112</p>
	<p>SUPPORTO MOLLA GAS GAS SPRING BRACKET</p> <p>COS.PEL. ref. SIMILAR ref. 1006.70103 504032791</p>
	<p>SUPPORTO MOLLA GAS GAS SPRING BRACKET</p> <p>COS.PEL. ref. SIMILAR ref. 1006.70104 504049432 DX RH</p> <p>1006.70105 504032799 SX LH</p>
	<p>CERNIERA SPORTELLO DOOR HINGE</p> <p>COS.PEL. ref. SIMILAR ref. 1006.70106 504032787</p>
	<p>RIVESTIMENTO PORTA A.B.S. DOOR SIDE PANEL A.B.S.</p> <p>COS.PEL. ref. SIMILAR ref. 1406.75006 504139860 DX RH</p> <p>1406.75005 504139861 SX LH</p>
 	<p>FANALINO CORNER LAMP</p> <p>COS.PEL. ref. SIMILAR ref. 1606.75600 504047573 DX-SX RH-LH</p>
 	<p>FANALINO VISIERA 03 -> SUN VISOR' MARKER 03 -></p> <p>COS.PEL. ref. SIMILAR ref. 1606.80046 504047265 DX RH</p> <p>1606.80047 504047264 SX LH</p>

Eurocargo 75e13/120e21

 	<p>FENDINEBBIA H1 FOG LAMP H1 COS.PEL. ref. SIMILAR ref. 1606.75602 504052352 DX RH</p> <p>1606.75601 504052353 SX LH</p>
 	<p>PROIETTORE H7 H7 - CORRETTORE ASSETTO MANUALE / ELETTRICO SENZA MOTORINO HEADLAMP H7 H7 - MANUAL LOAD LEVEL ADJUSTEMENT / ELECTRIC W/O MOTOR COS.PEL. ref. SIMILAR ref. 1606.80038 504020189 DX RH</p> <p>1606.80039 504020193 SX LH</p>
	<p>SERRATURA PORTA ELETTRICA ELECTRIC DOOR LOCK COS.PEL. ref. SIMILAR ref. 1706.60906 98411951 / 98416419 DX RH</p> <p>1706.60905 98411952 / 98416424 SX LH</p>
	<p>ARRESTO PORTA DOOR STOP COS.PEL. ref. SIMILAR ref. 1706.60908 5802132946 / 99476267 DX RH</p> <p>1706.60907 5802132944 / 99476268 SX LH</p>
	<p>MANIGLIA PORTA NERO - CON CHIAVE DOOR HANDLE BLACK - WITH KEY COS.PEL. ref. SIMILAR ref. 1706.80800 - DX RH</p> <p>1706.80801 - SX LH</p>
	<p>KIT MANIGLIE PORTE CON CHIAVE NERO - CON CHIAVE KIT DOOR HANDLE WITH KEY BLACK - WITH KEY COS.PEL. ref. SIMILAR ref. 1706.80802 504052936 DX-SX RH-LH</p>
	<p>GUIDA VETRO WINDOW FRAME COS.PEL. ref. SIMILAR ref. 1806.60134 98484152 DX RH</p> <p>1806.60133 98404902 SX LH</p>
	<p>ALZACRISTALLI ELETTRICO - CON MOTORINO - 2 PIN WINDOW REGULATOR ELECTRIC - WITH MOTOR - 2 PIN COS.PEL. ref. SIMILAR ref. 1906.60032 2997195 / 98407721 / 99487780 DX RH</p> <p>1906.60033 2997196 / 98407722 / 99487781 SX LH</p>



	<p>ALZACRISTALLI ELETTRICO - CON MOTORINO - 2 PIN WINDOW REGULATOR ELECTRIC - WITH MOTOR - 2 PIN COS.PEL. ref. SIMILAR ref. 1906.90030 504040988 / 504157968 / 5801324907 DX RH</p> <p>1906.90031 504040989 / 504157969 / 5801324893 SX LH</p>
	<p>TIRANTE COPRI BATTERIA CORTO 140 mm MUDGUARD TENSIONER SHORT 140 mm COS.PEL. ref. SIMILAR ref. 1006.90107 4605163</p>
	<p>TIRANTE COPRI BATTERIA LUNGO 144 mm MUDGUARD TENSIONER LONG 144 mm COS.PEL. ref. SIMILAR ref. 1006.90109 4784894</p>
	<p>MOLLA A GAS Lunghezza [mm] 706 Corsa [mm] 300 Forza scarto [N] 200 GAS SPRING Lenght [mm] 706 Stroke [mm] 300 Waste force [N] 200 COS.PEL. ref. SIMILAR ref. 2406.75100 504032792</p>
	<p>DEFLETTORI LATERALI CON CLIPS SIDOWINDOW DEFLECTORS WITH CLIPS COS.PEL. ref. SIMILAR ref. 3006.00000 -</p>
	<p>FANALE POSTERIORE 5 FUNZIONI REAR-LIGHT 5 FUNCTIONS COS.PEL. ref. SIMILAR ref. 008550 500382617 / 98421202 DX RH</p> <p>008560 500382616 / 98421203 SX LH</p> <p>TRASPARENTE / LENS 012621 42471138 / 7984015 DX RH 012721 42471137 / 7984016 SX LH</p>

Eurocargo 130e24/180e28











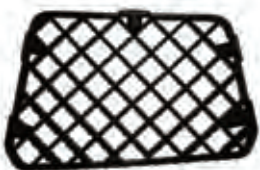

COS.IVE

<p>AD ESAURIMENTO SCORTE <small>UNTIL STOCKOUT</small></p> 	<p>GRIGLIA S.M.C. GRILLE S.M.C.</p> <p>COS.PEL. ref. SIMILAR ref. 106.75461 504027461</p>
	<p>PEDANA PARAFANGO CON ALETTA S.M.C. - GRIGIO FOOTSTEP MUDGUARD S.M.C. - GREY</p> <p>COS.PEL. ref. SIMILAR ref. 206.13000 504054940 / 504059309 DX RH</p> <p>206.13001 Griglia/Grille: 1006.18000 sup. - 1006.18001 inf. 504054941 / 504059310 SX LH</p> <p>Griglia/Grille: 1006.18000 sup. - 1006.18001 inf.</p>
	<p>PARAFANGO PEDANA SENZA ALETTA S.M.C. - GRIGIO FOOTSTEP MUDGUARD S.M.C. - GREY</p> <p>COS.PEL. ref. SIMILAR ref. 206.13002 504054942 DX RH</p> <p>206.13003 Griglia/Grille: 1006.18000 sup. - 1006.18001 inf. 504054943 SX LH</p> <p>Griglia/Grille: 1006.18000 sup. - 1006.18001 inf.</p>
	<p>RIPARAFANGO S.M.C. - GRIGIO REAR MUDGUARD S.M.C. - GREY</p> <p>COS.PEL. ref. SIMILAR ref. 206.13040 504055140 DX RH</p> <p>206.13041 504055141 SX LH</p>
 <p>cm 62,5</p>	<p>PARAURTI ANTERIORE P.P.G.F. - GRIGIO FRONT BUMPER P.P.G.F. - GREY</p> <p>COS.PEL. ref. SIMILAR ref. 406.13090 500042692 / 504027618 / 504049813</p>

 <p>cm 62,5</p>	<p>PARAURTI ANTERIORE CON FORI FENDI P.P.G.F. - GRIGIO FRONT BUMPER WITH HOLES P.P.G.F. - GREY</p> <p>COS.PEL. ref. SIMILAR ref. 406.13091 500042691 / 504027620 / 504049814</p>
	<p>SPORTELLINO PARAURTI BUMPER COVER</p> <p>COS.PEL. ref. SIMILAR ref. 406.75093 504043051 / 504043052 / 504102117</p>
	<p>COPERCHIO LATERALE SIDE COVER</p> <p>COS.PEL. ref. SIMILAR ref. DX RH 406.83944 500380095 / 504042188</p> <p>406.83945 500380094 / 504042187 SX LH</p>
	<p>TAPPO PARAURTI A.B.S. COVER BUMPER A.B.S.</p> <p>COS.PEL. ref. SIMILAR ref. 406.70096 500380066 / 500383459 / 504042191 / 504258139 / 504284012</p>
 <p>cm 211</p> <p>cm 30</p> <p>cm 69,5</p>	<p>VISIERA TECTOR TETTO BASSO SENZA STAFFE SENZA STAFFE - CON FORI FANALINI SUN VISOR LOW CAB WITHOUT BRACKET KIT WITHOUT BRACKET KIT</p> <p>COS.PEL. ref. SIMILAR ref. 706.75300 504061726</p> <p>Relativo kit staffe 1006.75300</p>
	<p>CONVOGLIATORE ARIA A.B.S. AIR CONVEYOR A.B.S.</p> <p>COS.PEL. ref. SIMILAR ref. DX RH 906.75280 504060280 / 504116074</p> <p>906.75281 504060281 / 504116073 SX LH</p>
	<p>MONTANTE PARABREZZA WINDSHIELD UPRIGHT</p> <p>COS.PEL. ref. SIMILAR ref. DX RH 906.75282 504027559 / 504116084</p> <p>906.75283 504027560 / 504116083 SX LH</p>
	<p>GRIGLIA PEDANA PLASTICA FOOTSTEP GRILLE PLASTIC</p> <p>COS.PEL. ref. SIMILAR ref. DX-SX RH-LH 1006.18000 504043817</p> <p>Per 206.75120-1 / 206.18011</p>

Eurocargo 130e24/180e28

	<p>GRIGLIA PEDANA PLASTICA FOOTSTEP GRILLE PLASTIC</p> <p>COS.PEL. ref. SIMILAR ref. 1006.18001 504043819</p> <p style="text-align: right;">DX-SX RH-LH</p>
	<p>MOLLETTA DI FISSAGGIO CLIP FIXING</p> <p>COS.PEL. ref. SIMILAR ref. 1006.70100 500380112</p>
	<p>SUPPORTO MOLLA GAS GAS SPRING BRACKET</p> <p>COS.PEL. ref. SIMILAR ref. 1006.70103 504032791</p>
	<p>SUPPORTO MOLLA GAS GAS SPRING BRACKET</p> <p>COS.PEL. ref. SIMILAR ref. 1006.70104 504049432 DX RH</p> <p>1006.70105 504032799 SX LH</p>
	<p>CERNIERA SPORTELLO DOOR HINGE</p> <p>COS.PEL. ref. SIMILAR ref. 1006.70106 504032787</p>
	<p>RIVESTIMENTO PORTA A.B.S. DOOR SIDE PANEL A.B.S.</p> <p>COS.PEL. ref. SIMILAR ref. 1406.75006 504139860 DX RH</p> <p>1406.75005 504139861 SX LH</p>
 	<p>FANALINO CORNER LAMP</p> <p>COS.PEL. ref. SIMILAR ref. 1606.75600 504047573 DX-SX RH-LH</p>
 	<p>FANALINO VISIERA 03 -> SUN VISOR' MARKER 03 -></p> <p>COS.PEL. ref. SIMILAR ref. 1606.80046 504047265 DX RH</p> <p>1606.80047 504047264 SX LH</p>

 	<p>FENDINEBBIA H1 FOG LAMP H1</p> <p>COS.PEL. ref. SIMILAR ref. 1606.75602 504052352</p> <p>1606.75601 504052353</p> <p style="text-align: right;">DX RH</p> <p style="text-align: right;">SX LH</p>
 	<p>PROIETTORE H7 H7 - CORRETTORE ASSETTO MANUALE / ELETTRICO SENZA MOTORINO HEADLAMP H7 H7 - MANUAL LOAD LEVEL ADJUSTEMENT / ELECTRIC W/O MOTOR</p> <p>COS.PEL. ref. SIMILAR ref. 1606.80038 504020189</p> <p>1606.80039 504020193</p> <p style="text-align: right;">DX RH</p> <p style="text-align: right;">SX LH</p>
	<p>SERRATURA PORTA ELETTRICA ELECTRIC DOOR LOCK</p> <p>COS.PEL. ref. SIMILAR ref. 1706.60906 98411951 / 98416419</p> <p>1706.60905 98411952 / 98416424</p> <p style="text-align: right;">DX RH</p> <p style="text-align: right;">SX LH</p>
	<p>ARRESTO PORTA DOOR STOP</p> <p>COS.PEL. ref. SIMILAR ref. 1706.60908 5802132946 / 99476267</p> <p>1706.60907 5802132944 / 99476268</p> <p style="text-align: right;">DX RH</p> <p style="text-align: right;">SX LH</p>
	<p>MANIGLIA PORTA NERO - CON CHIAVE DOOR HANDLE BLACK - WITH KEY</p> <p>COS.PEL. ref. SIMILAR ref. 1706.80800 -</p> <p>1706.80801 -</p> <p style="text-align: right;">DX RH</p> <p style="text-align: right;">SX LH</p>
	<p>KIT MANIGLIE PORTE CON CHIAVE NERO - CON CHIAVE KIT DOOR HANDLE WITH KEY BLACK - WITH KEY</p> <p>COS.PEL. ref. SIMILAR ref. 1706.80802 504052936</p> <p style="text-align: right;">DX-SX RH-LH</p>
	<p>GUIDA VETRO WINDOW FRAME</p> <p>COS.PEL. ref. SIMILAR ref. 1806.60134 98484152</p> <p>1806.60133 98404902</p> <p style="text-align: right;">DX RH</p> <p style="text-align: right;">SX LH</p>
	<p>ALZACRISTALLI ELETTRICO - CON MOTORINO - 2 PIN WINDOW REGULATOR ELECTRIC - WITH MOTOR - 2 PIN</p> <p>COS.PEL. ref. SIMILAR ref. 1906.60032 2997195 / 98407721 / 99487780</p> <p>1906.60033 2997196 / 98407722 / 99487781</p> <p style="text-align: right;">DX RH</p> <p style="text-align: right;">SX LH</p>

Eurocargo 130e24/180e28

	<p>ALZACRISTALLI ELETTRICO - CON MOTORINO - 2 PIN WINDOW REGULATOR ELECTRIC - WITH MOTOR - 2 PIN COS.PEL. ref. SIMILAR ref. 1906.90030 504040988 / 504157968 / 5801324907 DX RH</p> <p>1906.90031 504040989 / 504157969 / 5801324893 SX LH</p>
	<p>TIRANTE COPRI BATTERIA CORTO 140 mm MUDGUARD TENSIONER SHORT 140 mm COS.PEL. ref. SIMILAR ref. 1006.90107 4605163</p>
	<p>TIRANTE COPRI BATTERIA LUNGO 144 mm MUDGUARD TENSIONER LONG 144 mm COS.PEL. ref. SIMILAR ref. 1006.90109 4784894</p>
	<p>MOLLA A GAS Lunghezza [mm] 706 Corsa [mm] 300 Forza scarto [N] 200 GAS SPRING Lenght [mm] 706 Stroke [mm] 300 Waste force [N] 200 COS.PEL. ref. SIMILAR ref. 2406.75100 504032792</p>
	<p>DEFLETTORI LATERALI CON CLIPS SIDEWINDOW DEFLECTORS WITH CLIPS COS.PEL. ref. SIMILAR ref. 3006.00000 -</p>











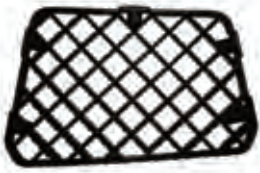

<p>AD ESAURIMENTO SCORTE <small>UPON THE SEL STOCK</small></p> 	<p>GRIGLIA S.M.C. GRILLE S.M.C.</p> <p>COS.PEL. ref. SIMILAR ref. 106.75461 504027461</p>
	<p>RIPARAFANGO S.M.C. - GRIGIO REAR MUDGUARD S.M.C. - GREY</p> <p>COS.PEL. ref. SIMILAR ref. 206.13040 504055140 DX RH</p> <p>206.13041 504055141 SX LH</p>
	<p>PEDANA PARAFANGO CON ALETTA S.M.C. - GRIGIO MUDGUARD FOOTSTEP S.M.C. - GREY</p> <p>COS.PEL. ref. SIMILAR ref. 206.18011 504054990 SX LH</p> <p>Griglia/Grille : 1006.18000</p>
	<p>PARAFANGO PEDANA S.M.C. - GRIGIO FOOTSTEP MUDGUARD S.M.C. - GREY</p> <p>COS.PEL. ref. SIMILAR ref. 206.18012 504054991 DX RH</p> <p>Griglia/Grille : 1006.18000 206.18013 504054992 SX LH</p> <p>Griglia/Grille : 1006.18000</p>
	<p>VASCHETTA PEDANA P.P.G.F. - GRIGIO FOOTSTEP P.P.G.F. - GREY</p> <p>COS.PEL. ref. SIMILAR ref. 306.18020 504055010 / 504060076 DX RH</p> <p>Griglia/Grille : 1006.18001 306.18021 504055011 / 504060077 SX LH</p> <p>Griglia/Grille : 1006.18001</p>



Tector 160e18/180e30

 <p>cm 62,5</p>	<p>PARAURTI ANTERIORE P.P.G.F. - GRIGIO FRONT BUMPER P.P.G.F. - GREY</p> <p>COS.PEL. ref. 406.13090 SIMILAR ref. 500042692 / 504027618 / 504049813</p>
 <p>cm 62,5</p>	<p>PARAURTI ANTERIORE CON FORI FENDI P.P.G.F. - GRIGIO FRONT BUMPER WITH HOLES P.P.G.F. - GREY</p> <p>COS.PEL. ref. 406.13091 SIMILAR ref. 500042691 / 504027620 / 504049814</p>
	<p>SPORTELLLO PARAURTI BUMPER COVER</p> <p>COS.PEL. ref. 406.75093 SIMILAR ref. 504043051 / 504043052 / 504102117</p>
	<p>COPERCHIO LATERALE SIDE COVER</p> <p>COS.PEL. ref. 406.83944 SIMILAR ref. 500380095 / 504042188 DX RH</p> <p>406.83945 500380094 / 504042187 SX LH</p>
	<p>TAPPO PARAURTI A.B.S. COVER BUMPER A.B.S.</p> <p>COS.PEL. ref. 406.70096 SIMILAR ref. 500380066 / 500383459 / 504042191 / 504258139 / 504284012</p>
	<p>CONVOGLIATORE ARIA A.B.S. AIR CONVEYOR A.B.S.</p> <p>COS.PEL. ref. 906.75280 SIMILAR ref. 504060280 / 504116074 DX RH</p> <p>906.75281 504060281 / 504116073 SX LH</p>
	<p>MONTANTE PARABREZZA WINDSHIELD UPRIGHT</p> <p>COS.PEL. ref. 906.75282 SIMILAR ref. 504027559 / 504116084 DX RH</p> <p>906.75283 504027560 / 504116083 SX LH</p>
	<p>GRIGLIA PEDANA PLASTICA FOOTSTEP GRILLE PLASTIC</p> <p>COS.PEL. ref. 1006.18000 SIMILAR ref. 504043817 DX-SX RH-LH</p> <p>Per 206.75120-1 / 206.18011</p>

Tector 160e18/180e30

	<p>GRIGLIA PEDANA PLASTICA FOOTSTEP GRILLE PLASTIC</p> <p>COS.PEL. ref. SIMILAR ref. 1006.18001 504043819</p> <p style="text-align: right;">DX-SX RH-LH</p>
	<p>SUPPORTO MOLLA GAS GAS SPRING BRACKET</p> <p>COS.PEL. ref. SIMILAR ref. 1006.70103 504032791</p>
	<p>SUPPORTO MOLLA GAS GAS SPRING BRACKET</p> <p>COS.PEL. ref. SIMILAR ref. 1006.70104 504049432</p> <p style="text-align: right;">DX RH</p> <p>1006.70105 504032799</p> <p style="text-align: right;">SX LH</p>
	<p>CERNIERA SPORTELLO DOOR HINGE</p> <p>COS.PEL. ref. SIMILAR ref. 1006.70106 504032787</p>
	<p>RIVESTIMENTO PORTA A.B.S. DOOR SIDE PANEL A.B.S.</p> <p>COS.PEL. ref. SIMILAR ref. 1406.75006 504139860</p> <p style="text-align: right;">DX RH</p> <p>1406.75005 504139861</p> <p style="text-align: right;">SX LH</p>
 	<p>FANALINO INGOMBRO CABINA DRIVER'S CAB SIDE MARKER</p> <p>COS.PEL. ref. SIMILAR ref. 1606.75604 504055623</p> <p style="text-align: right;">DX RH</p> <p>1606.75603 504045133</p> <p style="text-align: right;">SX LH</p>
 	<p>FANALINO VISIERA 03 -> SUN VISOR' MARKER 03 -></p> <p>COS.PEL. ref. SIMILAR ref. 1606.80046 504047265</p> <p style="text-align: right;">DX RH</p> <p>1606.80047 504047264</p> <p style="text-align: right;">SX LH</p>
 	<p>PROIETTORE H7 H7 - CORRETTORE ASSETTO MANUALE / ELETTRICO SENZA MOTORINO HEADLAMP H7 H7 - MANUAL LOAD LEVEL ADJUSTEMENT / ELECTRIC W/O MOTOR</p> <p>COS.PEL. ref. SIMILAR ref. 1606.80038 504020189</p> <p style="text-align: right;">DX RH</p> <p>1606.80039 504020193</p> <p style="text-align: right;">SX LH</p>

Tector 160e18/180e30









	<p>ALZACRISTALLI ELETTRICO - CON MOTORINO - 2 PIN WINDOW REGULATOR ELECTRIC - WITH MOTOR - 2 PIN</p> <p>COS.PEL. ref. SIMILAR ref.</p> <p>1906.90030 504040988 / 504157968 / 5801324907 DX RH</p> <p>1906.90031 504040989 / 504157969 / 5801324893 SX LH</p>
	<p>MOLLA A GAS Lunghezza [mm] 706 Corsa [mm] 300 Forza scarto [N] 200 GAS SPRING Lenght [mm] 706 Stroke [mm] 300 Waste force [N] 200</p> <p>COS.PEL. ref. SIMILAR ref.</p> <p>2406.75100 504032792</p>















	<p>GRIGLIA P.P. GRILLE P.P.</p> <p>COS.PEL. ref. SIMILAR ref. 106.70100 504258217</p>
	<p>PEDANA PARAFANGO C/ALETTA S.M.C. - NERO FOOTSTEP MUDGUARD S.M.C. - BLACK</p> <p>COS.PEL. ref. SIMILAR ref. 206.70120 504299444 DX RH</p> <p>206.70121 504299045 SX LH</p> <p>Griglia/grille : 1006.18000</p>
	<p>PARAURTI ANTERIORE FRONT BUMPER</p> <p>COS.PEL. ref. SIMILAR ref. 406.70090 504281887 / 5801797763 / 5801797825</p>
	<p>PARAURTI FENDINEBBIA APERTI FRONT BUMPER WITH HOLES</p> <p>COS.PEL. ref. SIMILAR ref. 406.70091 504258213 / 504281888 / 5801797764 / 5801797858 / 5801797941</p>
	<p>SPORTELLLO CENTRALE A.B.S. - NERO CENTRAL COVER A.B.S. - BLACK</p> <p>COS.PEL. ref. SIMILAR ref. 406.70092 504273193 / 504284010 DX RH</p> <p>406.70093 504273199 / 504284009 SX LH</p>

Eurocargo 2009 75e13/120e18

	<p>SPORTELLLO LATERALE A.B.S. SIDE COVER A.B.S.</p> <p>COS.PEL. ref. SIMILAR ref. 406.70094 504258137 / 504272598 DX RH</p> <p>406.70095 504258138 / 504272597 SX LH</p>
	<p>TAPPO PARAURTI A.B.S. COVER BUMPER A.B.S.</p> <p>COS.PEL. ref. SIMILAR ref. 406.70096 500380066 / 500383459 / 504042191 / 504258139 / 504284012</p>
	<p>PEDANA PARAURTI P.P. BUMPER FOOTSTEP P.P.</p> <p>COS.PEL. ref. SIMILAR ref. 406.70097 504273162</p>
	<p>SUPPORTO FENDINEBBIA P.A.G.F. FOG LAMP BRACKET P.A.G.F.</p> <p>COS.PEL. ref. SIMILAR ref. 406.70098 504274012 DX RH</p> <p>406.70099 504274013 SX LH</p>
	<p>SPECCHIO RETROVISORE ELETTRICO - RISCALDATO - BRACCIO LUNGO REAR-VIEW MIRROR ELECTRIC - HEATED - LONG ARM</p> <p>COS.PEL. ref. SIMILAR ref. 506.70100 504369995 / 5801341207 / DX RH 5801580263</p> <p>506.70101 504369979 / 5801341206 / SX LH 5801580261</p>
	<p>VETRO SPECCHIO RISCALDATO MIRROR GLASS HEATED</p> <p>COS.PEL. ref. SIMILAR ref. 506.90102 504197878 DX-SX RH-LH</p>
	<p>VETRO SPECCHIO GRANDANGOLO - RISCALDATO - RAGGIO 300 MIRROR GLASS WIDE ANGLE - HEATED - RADIUS 300</p> <p>COS.PEL. ref. SIMILAR ref. 506.90103 504197879 DX-SX RH-LH</p>
	<p>COPERCHIO RETROVISORE COVER MIRROR</p> <p>COS.PEL. ref. SIMILAR ref. 506.90104 504158975 DX RH</p> <p>506.90105 504158974 SX LH</p>

	<p>COPERCHIO RETROVISORE GRANDANGOLO COVER MIRRO WIDE ANGLE</p> <p>COS.PEL. ref. SIMILAR ref. 506.90106 504158977 DX RH</p> <p>506.90107 504158976 SX LH</p>
	<p>VISIERA TECTOR TETTO BASSO SENZA STAFFE SENZA STAFFE - CON FORI FANALINI SUN VISOR LOW CAB WITHOUT BRACKET KIT WITHOUT BRACKET KIT</p> <p>COS.PEL. ref. SIMILAR ref. 706.75300 504061726</p> <p>Relativo kit staffe 1006.75300</p>
	<p>CONVOGLIATORE ARIA A.B.S. AIR CONVEYOR A.B.S.</p> <p>COS.PEL. ref. SIMILAR ref. 906.75280 504060280 / 504116074 DX RH</p> <p>906.75281 504060281 / 504116073 SX LH</p>
	<p>MONTANTE PARABREZZA WINDSHIELD UPRIGHT</p> <p>COS.PEL. ref. SIMILAR ref. 906.75282 504027559 / 504116084 DX RH</p> <p>906.75283 504027560 / 504116083 SX LH</p>
	<p>GRIGLIA PEDANA PLASTICA FOOTSTEP GRILLE PLASTIC</p> <p>COS.PEL. ref. SIMILAR ref. 1006.18000 504043817 DX-SX RH-LH</p> <p>Per 206.75120-1 / 206.18011</p>
	<p>SUPPORTO MOLLA GAS GAS SPRING BRACKET</p> <p>COS.PEL. ref. SIMILAR ref. 1006.70103 504032791</p>
	<p>SUPPORTO MOLLA GAS GAS SPRING BRACKET</p> <p>COS.PEL. ref. SIMILAR ref. 1006.70104 504049432 DX RH</p> <p>1006.70105 504032799 SX LH</p>
	<p>CERNIERA SPORTELLO DOOR HINGE</p> <p>COS.PEL. ref. SIMILAR ref. 1006.70106 504032787</p>

Eurocargo 2009 75e13/120e18

	<p>BOTTONE PEDANA PARAURTI FRONT BUMPER CLIP</p> <p>COS.PEL. ref. SIMILAR ref. 1006.90110 504194581</p>
	<p>DOPPIA VITE M8 SCREW M8</p> <p>COS.PEL. ref. SIMILAR ref. 1006.90483 504173483</p>
 	<p>FANALINO VISIERA 03 -> SUN VISOR' MARKER 03 -></p> <p>COS.PEL. ref. SIMILAR ref. 1606.80046 504047265 DX RH</p> <p>1606.80047 504047264 SX LH</p>
 	<p>FANALINO ANTERIORE FRONT CORNER LAMP</p> <p>COS.PEL. ref. SIMILAR ref. 1606.90604 42555041 / 5801755123 DX RH</p> <p>1606.90605 42555042 / 5801755132 SX LH</p> <p>Relativo portalampada 1606.92810 Relativo portalampada 1606.92810</p>
	<p>PORTALAMPADA LAMP BULB HOLDER</p> <p>COS.PEL. ref. SIMILAR ref. 1606.92810 -</p> <p>Per / For : 1606.92802/3 - 1606.90604/5 - 1604.10604/5</p>
 	<p>PROIETTORE H7 H7 - 08-> - CORRETTORE ASSETTO MANUALE HEADLAMP H7 H7 - 08-> - MANUAL LOAD LEVEL ADJUSTMENT</p> <p>COS.PEL. ref. SIMILAR ref. 1606.90600 504238093 DX RH</p> <p>1606.90601 504238117 SX LH</p>
 	<p>PROIETTORE FENDINEBBIA ESTERNO H1 - 08 -> OUTSIDE FOG LAMP H1 - 08 -></p> <p>COS.PEL. ref. SIMILAR ref. 1606.90606 504181095 DX-SX RH-LH</p>
	<p>SERRATURA PORTA ELETTRICA ELECTRIC DOOR LOCK</p> <p>COS.PEL. ref. SIMILAR ref. 1706.60906 98411951 / 98416419 DX RH</p> <p>1706.60905 98411952 / 98416424 SX LH</p>

	<p>ARRESTO PORTA DOOR STOP</p> <p>COS.PEL. ref. SIMILAR ref. 1706.60908 5802132946 / 99476267 DX RH</p> <p>1706.60907 5802132944 / 99476268 SX LH</p>
	<p>GUIDA VETRO WINDOW FRAME</p> <p>COS.PEL. ref. SIMILAR ref. 1806.60134 98484152 DX RH</p> <p>1806.60133 98404902 SX LH</p>
	<p>ALZACRISTALLI ELETTRICO - CON MOTORINO - 2 PIN WINDOW REGULATOR ELECTRIC - WITH MOTOR - 2 PIN</p> <p>COS.PEL. ref. SIMILAR ref. 1906.90030 504040988 / 504157968 / 5801324907 DX RH</p> <p>1906.90031 504040989 / 504157969 / 5801324893 SX LH</p>
	<p>TIRANTE COPRI BATTERIA CORTO 140 mm MUDGUARD TENSIONER SHORT 140 mm</p> <p>COS.PEL. ref. SIMILAR ref. 1006.90107 4605163</p>
	<p>TIRANTE COPRI BATTERIA LUNGO 144 mm MUDGUARD TENSIONER LONG 144 mm</p> <p>COS.PEL. ref. SIMILAR ref. 1006.90109 4784894</p>
	<p>MOLLA A GAS Lunghezza [mm] 706 Corsa [mm] 300 Forza scarto [N] 200 GAS SPRING Lenght [mm] 706 Stroke [mm] 300 Waste force [N] 200</p> <p>COS.PEL. ref. SIMILAR ref. 2406.75100 504032792</p>
	<p>KIT PER CONNESSIONI ELETTRICHE Connettore SUPERSEAL 2 vie femmina KIT FOR ELECTRICAL JOINTS Connector SUPERSEAL ways female</p> <p>COS.PEL. ref. SIMILAR ref. 003123 -</p> <p>Connettore per la serie 1500.xxxxx</p>
	<p>FANALE POSTERIORE LED - 24V - CONNETTORE POSTERIORE AMP 1.5 REAR-LIGHT LED - 24V - REAR CONNECTOR AMP 1.5</p> <p>COS.PEL. ref. SIMILAR ref. 1500.00000 - DX RH</p> <p>1500.00001 - Relativo connettore multipolare 003120 SX LH</p> <p>TRASPARENTE / LENS Relativo connettore multipolare 003120</p>

Eurocargo 2009 120e21/180e28



COS.IVE

	<p>GRIGLIA P.P. GRILLE P.P.</p> <p>COS.PEL. ref. SIMILAR ref. 106.70100 504258217</p>
	<p>PEDANA PARAFANGO C/ALETTA S.M.C. - NERO FOOTSTEP MUDGUARD S.M.C. - BLACK</p> <p>COS.PEL. ref. SIMILAR ref. 206.18014 504301907 / 5801622723 DX RH</p> <p>206.18015 504301912 SX LH</p> <p>Griglia/Grille: 1006.70102 inf. - 1006.70108 sup. Griglia/Grille: 1006.70101 inf. - 1006.70107 sup.</p>
 <p>cm 56</p>	<p>PARAURTI ANTERIORE NERO FRONT BUMPER BLACK</p> <p>COS.PEL. ref. SIMILAR ref. 406.16090 504281893 / 5801802740</p>
 <p>cm 56</p>	<p>PARAURTI ANTERIORE CON FORI FENDI NERO FRONT BUMPER WITH HOLES BLACK</p> <p>COS.PEL. ref. SIMILAR ref. 406.16091 504281894 / 504281895 / 5801802741 / 5801804153</p>
 <p>cm 62</p>	<p>PARAURTI ANTERIORE CON DAM - NERO FRONT BUMPER WITH DAM - BLACK</p> <p>COS.PEL. ref. SIMILAR ref. 406.16092 504281899 / 5801802895</p>

	<p>PARAURTI ANTERIORE CON FORI FENDI - CON DAM - NERO FRONT BUMPER WITH HOLES - WITH DAM - BLACK</p> <p>COS.PEL. ref. SIMILAR ref. 406.16093 504281900 / 504281901 / 504284018 / 5801802888 / 5801802903 / 5801804155</p>
	<p>SPORTELLLO LATERALE A.B.S. SIDE COVER A.B.S.</p> <p>COS.PEL. ref. SIMILAR ref. 406.16094 504273184 / 5801609147 DX RH</p> <p>406.16095 504273185 / 5801609160 SX LH</p>
	<p>TAPPO PARAURTI A.B.S. COVER A.B.S.</p> <p>COS.PEL. ref. SIMILAR ref. 406.16096 504258162 / 5801606287</p>
	<p>SPORTELLLO CENTRALE A.B.S. - NERO CENTRAL COVER A.B.S. - BLACK</p> <p>COS.PEL. ref. SIMILAR ref. 406.70092 504273193 / 504284010 DX RH</p> <p>406.70093 504273199 / 504284009 SX LH</p>
	<p>PEDANA PARAURTI P.P. BUMPER FOOTSTEP P.P.</p> <p>COS.PEL. ref. SIMILAR ref. 406.70097 504273162</p>
	<p>SUPPORTO FENDINEBBIA P.A.G.F. FOG LAMP BRACKET P.A.G.F.</p> <p>COS.PEL. ref. SIMILAR ref. 406.70098 504274012 DX RH</p> <p>406.70099 504274013 SX LH</p>
	<p>PEDANA PARAURTI P.P. - NERO UPPER BUMPER FOOTSTEP P.P. - BLACK</p> <p>COS.PEL. ref. SIMILAR ref. 406.90103 504135514</p>
	<p>SPECCHIO RETROVISORE ELETTRICO - RISCALDATO - BRACCIO LUNGO REAR-VIEW MIRROR ELECTRIC - HEATED - LONG ARM</p> <p>COS.PEL. ref. SIMILAR ref. 506.70100 504369995 / 5801341207 / 5801580263 DX RH</p> <p>506.70101 504369979 / 5801341206 / 5801580261 SX LH</p>

	<p>VETRO SPECCHIO RISCALDATO MIRROR GLASS HEATED</p> <p>COS.PEL. ref. 506.90102 SIMILAR ref. 504197878</p> <p style="text-align: right;">DX-SX RH-LH</p>
	<p>VETRO SPECCHIO GRANDANGOLO - RISCALDATO - RAGGIO 300 MIRROR GLASS WIDE ANGLE - HEATED - RADIUS 300</p> <p>COS.PEL. ref. 506.90103 SIMILAR ref. 504197879</p> <p style="text-align: right;">DX-SX RH-LH</p>
	<p>COPERCHIO RETROVISORE COVER MIRROR</p> <p>COS.PEL. ref. 506.90104 SIMILAR ref. 504158975 DX RH</p> <p>506.90105 504158974 SX LH</p>
	<p>COPERCHIO RETROVISORE GRANDANGOLO COVER MIRROR WIDE ANGLE</p> <p>COS.PEL. ref. 506.90106 SIMILAR ref. 504158977 DX RH</p> <p>506.90107 504158976 SX LH</p>
	<p>VISIERA TECTOR TETTO BASSO SENZA STAFFE SENZA STAFFE - CON FORI FANALINI SUN VISOR LOW CAB WITHOUT BRACKET KIT WITHOUT BRACKET KIT</p> <p>COS.PEL. ref. 706.75300 SIMILAR ref. 504061726</p> <p style="text-align: right;">Relativo kit staffe 1006.75300</p>
	<p>CONVOGLIATORE ARIA A.B.S. AIR CONVEYOR A.B.S.</p> <p>COS.PEL. ref. 906.75280 SIMILAR ref. 504060280 / 504116074 DX RH</p> <p>906.75281 504060281 / 504116073 SX LH</p>
	<p>MONTANTE PARABREZZA WINDSHIELD UPRIGHT</p> <p>COS.PEL. ref. 906.75282 SIMILAR ref. 504027559 / 504116084 DX RH</p> <p>906.75283 504027560 / 504116083 SX LH</p>
	<p>GRIGLIA PEDANA INFERIORE PLASTICA LOWER FOOTSTEP GRILLE PLASTIC</p> <p>COS.PEL. ref. 1006.70102 SIMILAR ref. 504329078 DX RH</p> <p>1006.70101 504329077 SX LH</p>

Eurocargo 2009 120e21/180e28

	<p>SUPPORTO MOLLA GAS GAS SPRING BRACKET</p> <p>COS.PEL. ref. SIMILAR ref. 1006.70103 504032791</p>
	<p>SUPPORTO MOLLA GAS GAS SPRING BRACKET</p> <p>COS.PEL. ref. SIMILAR ref. 1006.70104 504049432 DX RH</p> <p>1006.70105 504032799 SX LH</p>
	<p>CERNIERA SPORTELLO DOOR HINGE</p> <p>COS.PEL. ref. SIMILAR ref. 1006.70106 504032787</p>
	<p>GRIGLIA PEDANA SUPERIORE UPPER FOOTSTEP GRILLE</p> <p>COS.PEL. ref. SIMILAR ref. 1006.70108 504329074 DX RH</p> <p>1006.70107 504329073 SX LH</p>
	<p>BOTTONE PEDANA PARAURTI FRONT BUMPER CLIP</p> <p>COS.PEL. ref. SIMILAR ref. 1006.90110 504194581</p>
 	<p>FANALINO VISIERA 03 -> SUN VISOR' MARKER 03 -></p> <p>COS.PEL. ref. SIMILAR ref. 1606.80046 504047265 DX RH</p> <p>1606.80047 504047264 SX LH</p>
 	<p>FANALINO ANTERIORE FRONT CORNER LAMP</p> <p>COS.PEL. ref. SIMILAR ref. 1606.90604 42555041 / 5801755123 DX RH</p> <p>1606.90605 42555042 / 5801755132 SX LH</p> <p>Relativo portalamпада 1606.92810 Relativo portalamпада 1606.92810</p>
	<p>PORTALAMPADA LAMP BULB HOLDER</p> <p>COS.PEL. ref. SIMILAR ref. 1606.92810 -</p> <p>Per / For : 1606.92802/3 - 1606.90604/5 - 1604.10604/5</p>

Eurocargo 2009 120e21/180e28

 	<p>PROIETTORE H7 H7 - 08-> - CORRETTORE ASSETTO MANUALE HEADLAMP H7 H7 - 08-> - MANUAL LOAD LEVEL ADJUSTMENT COS.PEL. ref. SIMILAR ref. 1606.90600 504238093 DX RH</p> <p>1606.90601 504238117 SX LH</p>
 	<p>PROIETTORE FENDINEBBIA ESTERNO H1 - 08 -> OUTSIDE FOG LAMP H1 - 08 -> COS.PEL. ref. SIMILAR ref. 1606.90606 504181095 DX-SX RH-LH</p>
	<p>SERRATURA PORTA ELETTRICA ELECTRIC DOOR LOCK COS.PEL. ref. SIMILAR ref. 1706.60906 98411951 / 98416419 DX RH</p> <p>1706.60905 98411952 / 98416424 SX LH</p>
	<p>ARRESTO PORTA DOOR STOP COS.PEL. ref. SIMILAR ref. 1706.60908 5802132946 / 99476267 DX RH</p> <p>1706.60907 5802132944 / 99476268 SX LH</p>
	<p>GUIDA VETRO WINDOW FRAME COS.PEL. ref. SIMILAR ref. 1806.60134 98484152 DX RH</p> <p>1806.60133 98404902 SX LH</p>
<p>AD ESAURIMENTO SCORTE UNTIL SELL-OUT</p> 	<p>VASCHETTA ESPANSIONE EXPANSION TANK COS.PEL. ref. SIMILAR ref. 2106.70080 98426669</p>
 <p>cm 14</p>	<p>TIRANTE COPRI BATTERIA CORTO 140 mm MUDGUARD TENSIONER SHORT 140 mm COS.PEL. ref. SIMILAR ref. 1006.90107 4605163</p>
 <p>cm 14,4</p>	<p>TIRANTE COPRI BATTERIA LUNGO 144 mm MUDGUARD TENSIONER LONG 144 mm COS.PEL. ref. SIMILAR ref. 1006.90109 4784894</p>

	<p>MOLLA A GAS Lunghezza [mm] 706 Corsa [mm] 300 Forza scarto [N] 200</p> <p>GAS SPRING Lenght [mm] 706 Stroke [mm] 300 Waste force [N] 200</p> <p>COS.PEL. ref. SIMILAR ref. 2406.75100 504032792</p>
	<p>KIT PER CONNESSIONI ELETTRICHE Connettore SUPERSEAL 2 vie femmina</p> <p>KIT FOR ELECTRICAL JOINTS Connector SUPERSEAL ways female</p> <p>COS.PEL. ref. SIMILAR ref. 003123 -</p> <p>Connettore per la serie 1500.xxxxx</p>
	<p>FANALE POSTERIORE LED - 24V - CONNETTORE POSTERIORE AMP 1.5</p> <p>REAR-LIGHT LED - 24V - REAR CONNECTOR AMP 1.5</p> <p>COS.PEL. ref. SIMILAR ref.</p> <p>1500.00000 -</p> <p>1500.00001 -</p> <p>TRASPARENTE / LENS</p> <p>Relativo connettore multipolare 003120</p> <p>Relativo connettore multipolare 003120</p> <p>DX RH</p> <p>SX LH</p>

Eurocargo 75-2015



	<p>GRIGLIA S.M.C. - PRIMER GRILLE S.M.C. - PRIMER</p> <p>COS.PEL. ref. SIMILAR ref. 106.18150 5801690072</p>
	<p>GRIGLIA A.B.S. GRILLE A.B.S.</p> <p>COS.PEL. ref. SIMILAR ref. 106.18151 5801690084</p>
	<p>DECORAZIONE DECORATION</p> <p>COS.PEL. ref. SIMILAR ref.</p> <p>106.18152 5801711046 DX RH</p> <p>106.18153 5801711048 SX LH</p>
	<p>DECORAZIONE CENTRALE CENTRAL DECORATION</p> <p>COS.PEL. ref. SIMILAR ref. 106.18154 5801733767</p>
	<p>PEDANA PARAFANGO C/ALETTA S.M.C. - NERO FOOTSTEP MUDGUARD S.M.C. - BLACK</p> <p>COS.PEL. ref. SIMILAR ref. 206.70120 504299444 DX RH</p> <p>206.70121 504299045 SX LH</p> <p>Griglia/grille : 1006.18000</p>

	<p>TAPPO TELECAMERA PER PARAURTI P.P. COVER BUMPER P.P.</p> <p>COS.PEL. ref. SIMILAR ref. 406.18093 5801938050</p>
	<p>PARAURTI ANTERIORE SENZA FORI FENDI FRONT BUMPER WITHOUT HOLES</p> <p>COS.PEL. ref. SIMILAR ref. 406.71090 5801696201</p>
	<p>PARAURTI ANTERIORE CON FORI FENDI FRONT BUMPER WITH HOLES</p> <p>COS.PEL. ref. SIMILAR ref. 406.71091 5801690552</p>
	<p>PARAURTI ANTERIORE C/FORI FENDI E LAVAFARI FRONT BUMPER WITH HOLES</p> <p>COS.PEL. ref. SIMILAR ref. 406.71092 5801690553 / 5801693353</p>
	<p>TAPPO LATERALE SIDE COVER</p> <p>COS.PEL. ref. SIMILAR ref. 406.71094 5801693456 DX RH</p> <p>406.71093 5801693457 SX LH</p>
	<p>TAPPO CENTRALE COVER</p> <p>COS.PEL. ref. SIMILAR ref. 406.71096 5801693487 DX RH</p> <p>406.71095 5801693491 SX LH</p>
	<p>TAPPO ROTONDO ROUND COVER</p> <p>COS.PEL. ref. SIMILAR ref. 406.71098 5801693540 DX RH</p> <p>406.71097 5801693556 SX LH</p>
	<p>PEDANA PARAURTI BUMPER FOOTSTEP</p> <p>COS.PEL. ref. SIMILAR ref. 406.71099 5801692884</p>

Eurocargo 75-2015

	<p>SUPPORTO FENDINEBBIA FOG LAMP BRACKET</p> <p>COS.PEL. ref. SIMILAR ref. 406.71100 5801693423</p> <p>406.71101 5801693424</p> <p style="text-align: right;">DX RH</p> <p style="text-align: right;">SX LH</p>
	<p>SUPPORTO FENDINEBBIA FOG LAMP BRACKET</p> <p>COS.PEL. ref. SIMILAR ref. 406.71102 5801693428</p> <p>406.71103 5801693429</p> <p style="text-align: right;">DX RH</p> <p style="text-align: right;">SX LH</p>
	<p>CONVOGLIATORE ARIA A.B.S. AIR CONVEYOR A.B.S.</p> <p>COS.PEL. ref. SIMILAR ref. 906.71180 5801690105 / 5802055522</p> <p>906.71181 5801690102 / 5802055523</p> <p style="text-align: right;">DX RH</p> <p style="text-align: right;">SX LH</p>
	<p>MONTANTE PARABREZZA WINDSHIELD UPRIGHT</p> <p>COS.PEL. ref. SIMILAR ref. 906.75282 504027559 / 504116084</p> <p>906.75283 504027560 / 504116083</p> <p style="text-align: right;">DX RH</p> <p style="text-align: right;">SX LH</p>
	<p>SUPPORTO MOLLA GAS GAS SPRING BRACKET</p> <p>COS.PEL. ref. SIMILAR ref. 1006.70104 504049432</p> <p>1006.70105 504032799</p> <p style="text-align: right;">DX RH</p> <p style="text-align: right;">SX LH</p>
 	<p>FANALINO LATERALE 4 LED SIDE LAMP 4 LED</p> <p>COS.PEL. ref. SIMILAR ref. 002986 5801631615</p> <p style="text-align: right;">DX-SX RH-LH</p>
 	<p>FANALINO CORNER LAMP</p> <p>COS.PEL. ref. SIMILAR ref. 1606.71700 5801738337</p> <p style="text-align: right;">DX-SX RH-LH</p>
 <p>EUROCARGO 2003</p>	<p>FANALINO LATERALE CORNER LAMP</p> <p>COS.PEL. ref. SIMILAR ref. 1606.75924 504133023 / 5801573143</p> <p>1606.75925 504107550 / 5801573145</p> <p style="text-align: right;">DX RH</p> <p style="text-align: right;">SX LH</p>

	<p>PROIETTORE FENDINEBBIA ESTERNO H1 - 08 -> OUTSIDE FOG LAMP H1 - 08 -></p> <p>COS.PEL. ref. SIMILAR ref. 1606.90606 504181095</p> <p style="text-align: right;">DX-SX RH-LH</p>
	<p>PROIETTORE CORRETTORE ASSETTO MANUALE - CON CENTRALINA FRONT LAMP MANUAL LOAD LEVEL ADJUSTEMENT - WITH CONTROL UNIT</p> <p>COS.PEL. ref. SIMILAR ref. 1606.92800 5801745452</p> <p style="text-align: right;">DX RH</p> <p>1606.92801 Relativa centralina 1606.92812 5801745449 SX LH</p> <p style="text-align: right;">Relativa centralina 1606.92812</p>
	<p>PROIETTORE CORRETTORE ASSETTO MANUALE SENZA CENTRALINA HEADLAMP MANUAL LOAD LEVEL ADJUSTEMENT WITHOUT ELECTRONIC CONTROL UNIT</p> <p>COS.PEL. ref. SIMILAR ref. 1606.92808 -</p> <p style="text-align: right;">DX RH</p> <p>1606.92809 - SX LH</p>
	<p>CERNIERA HINGE</p> <p>COS.PEL. ref. SIMILAR ref. 1706.18000 5801527115 / 5801912787</p>
	<p>SERRATURA PORTA ELETTRICA ELECTRIC DOOR LOCK</p> <p>COS.PEL. ref. SIMILAR ref. 1706.60906 98411951 / 98416419</p> <p style="text-align: right;">DX RH</p> <p>1706.60905 98411952 / 98416424 SX LH</p>
	<p>ARRESTO PORTA DOOR STOP</p> <p>COS.PEL. ref. SIMILAR ref. 1706.60908 5802132946 / 99476267</p> <p style="text-align: right;">DX RH</p> <p>1706.60907 5802132944 / 99476268 SX LH</p>
	<p>GUIDA VETRO WINDOW FRAME</p> <p>COS.PEL. ref. SIMILAR ref. 1806.60134 98484152</p> <p style="text-align: right;">DX RH</p> <p>1806.60133 98404902 SX LH</p>
 <p style="text-align: center;">cm 14</p>	<p>TIRANTE COPRI BATTERIA CORTO 140 mm MUDGUARD TENSIONER SHORT 140 mm</p> <p>COS.PEL. ref. SIMILAR ref. 1006.90107 4605163</p>









Eurocargo 75-2015

 <p>cm 14,4</p>	<p>TIRANTE COPRI BATTERIA LUNGO 144 mm MUDGUARD TENSIONER LONG 144 mm</p> <p>COS.PEL. ref. SIMILAR ref. 1006.90109 4784894</p>
	<p>MOLLA A GAS Lunghezza [mm] 706 Corsa [mm] 300 Forza scarto [N] 200 GAS SPRING Lenght [mm] 706 Stroke [mm] 300 Waste force [N] 200</p> <p>COS.PEL. ref. SIMILAR ref. 2406.75100 504032792</p>
	<p>KIT PER CONNESSIONI ELETTRICHE Connettore SUPERSEAL 2 vie femmina KIT FOR ELECTRICAL JOINTS Connector SUPERSEAL ways female</p> <p>COS.PEL. ref. SIMILAR ref. 003123 -</p> <p>Connettore per la serie 1500.xxxxx</p>
 <p>15,2 cm</p>	<p>FANALE POSTERIORE LED - 24V - CONNETTORE POSTERIORE AMP 1.5 REAR-LIGHT LED - 24V - REAR CONNECTOR AMP 1.5</p> <p>COS.PEL. ref. SIMILAR ref. 1500.00000 - - Relativo connettore multipolare 003120 DX RH 1500.00001 - - Relativo connettore multipolare 003120 SX LH TRASPARENTE / LENS</p>



	<p>GRIGLIA S.M.C. - PRIMER GRILLE S.M.C. - PRIMER</p> <p>COS.PEL. ref. SIMILAR ref. 106.18150 5801690072</p>
	<p>GRIGLIA A.B.S. GRILLE A.B.S.</p> <p>COS.PEL. ref. SIMILAR ref. 106.18151 5801690084</p>
	<p>DECORAZIONE DECORATION</p> <p>COS.PEL. ref. SIMILAR ref. 106.18152 5801711046 DX RH</p> <p>106.18153 5801711048 SX LH</p>
	<p>DECORAZIONE CENTRALE CENTRAL DECORATION</p> <p>COS.PEL. ref. SIMILAR ref. 106.18154 5801733767</p>
	<p>PEDANA PARAFANGO C/ALETTA S.M.C. - NERO FOOTSTEP MUDGUARD S.M.C. - BLACK</p> <p>COS.PEL. ref. SIMILAR ref. 206.18014 504301907 / 5801622723 DX RH</p> <p>206.18015 Griglia/Grille: 1006.70102 inf. - 1006.70108 sup. 504301912 SX LH</p> <p>Griglia/Grille: 1006.70101 inf. - 1006.70107 sup.</p>

Eurocargo 130-2015

	<p>TAPPO TELECAMERA PER PARAU RTI P.P. COVER BUMPER P.P.</p> <p>COS.PEL. ref. SIMILAR ref. 406.18093 5801938050</p>
 <p>cm 57</p>	<p>PARAU RTI ANTERIORE SENZA FORI FRONT BUMPER WITHOUT FOG LAMPS HOLES</p> <p>COS.PEL. ref. SIMILAR ref. 406.18100 5801690583</p>
 <p>cm 57</p>	<p>PARAU RTI ANTERIORE CON FORI FENDI FRONT BUMPER WITH FOG LAMPS HOLES</p> <p>COS.PEL. ref. SIMILAR ref. 406.18101 5801690585</p>
 <p>cm 57</p>	<p>PARAU RTI ANT. CON FORI FENDI E FORI LAVAF. APERTI FRONT BUMPER WITH FOG LAMPS HOLES WITH GLASS WIPERS HOLES</p> <p>COS.PEL. ref. SIMILAR ref. 406.18102 5801690586</p>
 <p>cm 62</p>	<p>PARAU RTI ANTERIORE SENZA FORI CON DAM FRONT BUMPER W/O FOG LAMPS HOLES</p> <p>COS.PEL. ref. SIMILAR ref. 406.18103 5801690588</p>
 <p>cm 62</p>	<p>PARAU RTI ANTERIORE CON FORI FENDI E LAVAF. CHIUSI CON DAM FRONT BUMPER WITH DAM WITH FOG LAMPS HOLES W/O GLASS WIPERS HOLES</p> <p>COS.PEL. ref. SIMILAR ref. 406.18104 5801690590</p>
 <p>cm 62</p>	<p>PARAU RTI ANT. CON FORI FENDI E FORI LAVAF. APERTI CON DAM FRONT BUMPER WITH DAM WITH FOG LAMPS HOLES WITH GLASS WIPERS HOLES</p> <p>COS.PEL. ref. SIMILAR ref. 406.18105 5801690628</p>
	<p>SUPPORTO FENDINEBBIA FOG LAMP BRACKET</p> <p>COS.PEL. ref. SIMILAR ref. 406.18090 5801691384 DX RH</p> <p>406.18089 5801691386 SX LH</p>

	<p>SUPPORTO FENDINEBBIA FOG LAMP BRACKET</p> <p>COS.PEL. ref. SIMILAR ref. 406.18092 5801692253 DX RH</p> <p>406.18091 5801692254 SX LH</p>
	<p>TAPPO PARAURTI BUMPER COVER</p> <p>COS.PEL. ref. SIMILAR ref. 406.18094 5801692865 DX RH</p> <p>406.18095 5801692867 SX LH</p>
	<p>TAPPO PARAURTI BUMPER COVER</p> <p>COS.PEL. ref. SIMILAR ref. 406.18096 5801692850 DX RH</p> <p>406.18097 5801692854 SX LH</p>
	<p>TAPPO PARAURTI BUMPER COVER</p> <p>COS.PEL. ref. SIMILAR ref. 406.18098 5801692828 DX RH</p> <p>406.18099 5801692841 SX LH</p>
	<p>CONVOGLIATORE ARIA A.B.S. AIR CONVEYOR A.B.S.</p> <p>COS.PEL. ref. SIMILAR ref. 906.71180 5801690105 / 5802055522 DX RH</p> <p>906.71181 5801690102 / 5802055523 SX LH</p>
	<p>MONTANTE PARABREZZA WINDSHIELD UPRIGHT</p> <p>COS.PEL. ref. SIMILAR ref. 906.75282 504027559 / 504116084 DX RH</p> <p>906.75283 504027560 / 504116083 SX LH</p>
	<p>GRIGLIA PEDANA INFERIORE PLASTICA LOWER FOOTSTEP GRILLE PLASTIC</p> <p>COS.PEL. ref. SIMILAR ref. 1006.70102 504329078 DX RH</p> <p>1006.70101 504329077 SX LH</p>
	<p>SUPPORTO MOLLA GAS GAS SPRING BRACKET</p> <p>COS.PEL. ref. SIMILAR ref. 1006.70104 504049432 DX RH</p> <p>1006.70105 504032799 SX LH</p>

Eurocargo 130-2015

	<p>GRIGLIA PEDANA SUPERIORE UPPER FOOTSTEP GRILLE</p> <p>COS.PEL. ref. SIMILAR ref. 1006.70108 504329074</p> <p>1006.70107 504329073</p> <p style="text-align: right;">DX RH SX LH</p>
	<p>GRIGLIA PEDANA FOOTSTEP GRILLE</p> <p>COS.PEL. ref. SIMILAR ref. 1006.70110 504329071</p> <p style="text-align: right;">DX RH</p> <p style="text-align: center;">Relativa pedana: OE 504299444</p>
 	<p>FANALINO LATERALE 4 LED SIDE LAMP 4 LED</p> <p>COS.PEL. ref. SIMILAR ref. 002986 5801631615</p> <p style="text-align: right;">DX-SX RH-LH</p>
 	<p>FANALINO CORNER LAMP</p> <p>COS.PEL. ref. SIMILAR ref. 1606.71700 5801738337</p> <p style="text-align: right;">DX-SX RH-LH</p>
 <p>EUROCARGO 2003</p>	<p>FANALINO LATERALE CORNER LAMP</p> <p>COS.PEL. ref. SIMILAR ref. 1606.75924 504133023 / 5801573143</p> <p>1606.75925 504107550 / 5801573145</p> <p style="text-align: right;">DX RH SX LH</p>
 	<p>PROIETTORE FENDINEBBIA ESTERNO H1 - 08 -> OUTSIDE FOG LAMP H1 - 08 -></p> <p>COS.PEL. ref. SIMILAR ref. 1606.90606 504181095</p> <p style="text-align: right;">DX-SX RH-LH</p>
 	<p>PROIETTORE CORRETTORE ASSETTO MANUALE - CON CENTRALINA FRONT LAMP MANUAL LOAD LEVEL ADJUSTEMENT - WITH CONTROL UNIT</p> <p>COS.PEL. ref. SIMILAR ref. 1606.92800 5801745452</p> <p>1606.92801 Relativa centralina 1606.92812 5801745449</p> <p style="text-align: right;">DX RH SX LH</p> <p style="text-align: center;">Relativa centralina 1606.92812</p>
 	<p>PROIETTORE CORRETTORE ASSETTO MANUALE SENZA CENTRALINA HEADLAMP MANUAL LOAD LEVEL ADJUSTEMENT WITHOUT ELECTRONIC CONTROL UNIT</p> <p>COS.PEL. ref. SIMILAR ref. 1606.92808 -</p> <p>1606.92809 -</p> <p style="text-align: right;">DX RH SX LH</p>

	<p>SERRATURA PORTA ELETTRICA ELECTRIC DOOR LOCK</p> <p>COS.PEL. ref. SIMILAR ref. 1706.60906 98411951 / 98416419 DX RH</p> <p>1706.60905 98411952 / 98416424 SX LH</p>
	<p>ARRESTO PORTA DOOR STOP</p> <p>COS.PEL. ref. SIMILAR ref. 1706.60908 5802132946 / 99476267 DX RH</p> <p>1706.60907 5802132944 / 99476268 SX LH</p>
	<p>GUIDA VETRO WINDOW FRAME</p> <p>COS.PEL. ref. SIMILAR ref. 1806.60134 98484152 DX RH</p> <p>1806.60133 98404902 SX LH</p>
	<p>TIRANTE COPRI BATTERIA CORTO 140 mm MUDGUARD TENSIONER SHORT 140 mm</p> <p>COS.PEL. ref. SIMILAR ref. 1006.90107 4605163</p>
	<p>TIRANTE COPRI BATTERIA LUNGO 144 mm MUDGUARD TENSIONER LONG 144 mm</p> <p>COS.PEL. ref. SIMILAR ref. 1006.90109 4784894</p>
	<p>MOLLA A GAS Lunghezza [mm] 706 Corsa [mm] 300 Forza scarto [N] 200 GAS SPRING Lenght [mm] 706 Stroke [mm] 300 Waste force [N] 200</p> <p>COS.PEL. ref. SIMILAR ref. 2406.75100 504032792</p>
	<p>KIT PER CONNESSIONI ELETTRICHE Connettore SUPERSEAL 2 vie femmina KIT FOR ELECTRICAL JOINTS Connector SUPERSEAL ways female</p> <p>COS.PEL. ref. SIMILAR ref. 003123 -</p> <p>Connettore per la serie 1500.xxxxx</p>
	<p>FANALE POSTERIORE LED - 24V - CONNETTORE POSTERIORE AMP 1.5 REAR-LIGHT LED - 24V - REAR CONNECTOR AMP 1.5</p> <p>COS.PEL. ref. SIMILAR ref. 1500.00000 - DX RH 1500.00001 - SX LH Relativo connettore multipolare 003120 Relativo connettore multipolare 003120 TRASPARENTE / LENS</p>

Gamma Zeta



COS.IVE

<p>AD ESAURIMENTO SCORTE UNTIL SELL-OUT</p> 	<p>PARAFANGO R.I.M. - GRIGIO MUDGUARD R.I.M. - GREY COS.PEL. ref. SIMILAR ref. 206.68640 9068641 206.68639 9068642</p> <p style="text-align: right;">DX RH SX LH</p>
	<p>PEDANA CON FANALINO - R.I.M. - GRIGIO FOOTSTEP WITH LAMP - R.I.M. - GREY COS.PEL. ref. SIMILAR ref. 306.70228 9070228 306.70229 9070229</p> <p style="text-align: right;">DX RH SX LH</p>
	<p>PARAURTÌ ANTERIORE CON STAFFA R.I.M. - GRIGIO FRONT BUMPER WITH BRACKET R.I.M. - GREY COS.PEL. ref. SIMILAR ref. 406.11514 9068599</p>



	<p>TRAVERSA SOTTO MASCHERINA STRATIFICAZIONE MANUALE - BIANCO LOWER FRONT PANEL G.R.P. - WHITE</p> <p>COS.PEL. ref. SIMILAR ref. 106.11501 4814210</p>
<p>AD ESAURIMENTO SCORTE UNTIL SELLS-OUT</p> 	<p>PORTA FRECCIA R.I.M. LAMP HOUSING R.I.M.</p> <p>COS.PEL. ref. SIMILAR ref. 106.11503 4786009</p> <p style="text-align: right;">SX LH</p>
<p>AD ESAURIMENTO SCORTE UNTIL SELLS-OUT</p> 	<p>RIPARAFANGO POSTERIORE R.I.M. - GRIGIO REAR MUDGUARD R.I.M. - GREY</p> <p>COS.PEL. ref. SIMILAR ref. 206.11522 4787187</p> <p style="text-align: right;">DX RH</p> <p>206.11523 4787184</p> <p style="text-align: right;">SX LH</p>
	<p>PEDANA R.I.M. - GRIGIO FOOTSTEP R.I.M. - GREY</p> <p>COS.PEL. ref. SIMILAR ref. 306.11530 4786002</p> <p style="text-align: right;">DX RH</p> <p>306.11531 4786003</p> <p style="text-align: right;">SX LH</p>
<p>AD ESAURIMENTO SCORTE UNTIL SELLS-OUT</p> 	<p>TERMINALE PARAURTI BUMPER END COVERING</p> <p>COS.PEL. ref. SIMILAR ref. 406.11533 4786006</p> <p style="text-align: right;">SX LH</p>

115.17 / 135.17 / 145.17



PROIETTORE
HEADLAMP

COS.PEL. ref.

1606.11510

SIMILAR ref.

4814863

DX-SX RH-LH



<p>AD ESAURIMENTO SCORTE UNTIL SELLS-OUT</p> 	<p>FRONTALE SUPERIORE R.T.M. - GRIGIO FRONT PANEL R.T.M. - GREY</p> <p>COS.PEL. ref. SIMILAR ref. 106.19048 42332745</p>
<p>AD ESAURIMENTO SCORTE UNTIL SELLS-OUT</p> 	<p>SEMIPARAFANGO LAT. PARTE POST. REAR MUDGUARD</p> <p>COS.PEL. ref. SIMILAR ref. 206.19031 42341982</p> <p style="text-align: right;">SX LH</p>
<p>AD ESAURIMENTO SCORTE UNTIL SELLS-OUT</p> 	<p>PARAFANGO MUDGUARD</p> <p>COS.PEL. ref. SIMILAR ref. 206.32881 42332881</p> <p style="text-align: right;">SX LH</p>
<p>AD ESAURIMENTO SCORTE UNTIL SELLS-OUT</p> 	<p>PEDANA S.M.C. - GRIGIO FOOTSTEP S.M.C. - GREY</p> <p>COS.PEL. ref. SIMILAR ref. 306.19049 42332920</p> <p style="text-align: right;">SX LH</p>
<p>AD ESAURIMENTO SCORTE UNTIL SELLS-OUT</p> 	<p>PARETE PEDANA METALLO SIDE FOOTSTEP STEEL</p> <p>COS.PEL. ref. SIMILAR ref. 306.42252 42342252</p> <p style="text-align: right;">DX RH</p>

Turbostar 190

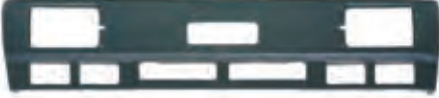
	<p>PARAURTI ANTERIORE R.I.M. - GRIGIO FRONT BUMPER R.I.M. - GREY</p> <p>COS.PEL. ref. SIMILAR ref. 406.01948 42092364</p>
	<p>SOTTOPARAURTI A.B.S. SPOILER A.B.S.</p> <p>COS.PEL. ref. SIMILAR ref. 406.19048 42348003</p>
	<p>RETROVISORE COMPLETO COMPLETE MIRROR</p> <p>COS.PEL. ref. SIMILAR ref. 506.19048 8123386 / 98424107 DX-SX RH-LH</p>
<p>AD ESAURIMENTO SCORTE UNTIL SPILL-OUT</p> 	<p>CORNICE FARO R.I.M. - GRIGIO HEADLIGHT BRACKET R.I.M. - GREY</p> <p>COS.PEL. ref. SIMILAR ref. 1106.48043 42348001 SX LH</p>
 	<p>FANALINO LATERALE CORNER LAMP</p> <p>COS.PEL. ref. SIMILAR ref. 1606.19480 42342171 DX-SX RH-LH</p>
<p>AD ESAURIMENTO SCORTE UNTIL SPILL-OUT</p> 	<p>MANIGLIA PORTA CON CHIAVE DOOR HANDLE WITH KEY</p> <p>COS.PEL. ref. SIMILAR ref. 1706.19042 4786977 DX RH</p> <p>1706.19043 4786978 SX LH</p>
<p>AD ESAURIMENTO SCORTE UNTIL SPILL-OUT</p> 	<p>KIT MANIGLIE GRIGIO - CON CHIAVE KIT DOOR HANDLES GREY - WITH KEY</p> <p>COS.PEL. ref. SIMILAR ref. 1706.19044 - DX-SX RH-LH</p>
<p>AD ESAURIMENTO SCORTE UNTIL SPILL-OUT</p> 	<p>BLOCCHETTO CON 2 CHIAVI DOOR HANDLE LOCKS WITH TWO KEYS</p> <p>COS.PEL. ref. SIMILAR ref. 1706.19045 93017949</p>

	<p>TRAFILATO VANO PORTA ROTOLI MT. 25 DOOR OPENING WEATHER STRIP ROLLS MT. 25</p> <p>COS.PEL. ref. SIMILAR ref. 1806.19020 42343172</p>
<p>AD ESAURIMENTO SCORTE UNTIL SELL-OUT</p> 	<p>ALZACRISTALLI MANUALE WINDOW REGULATOR MANUAL</p> <p>COS.PEL. ref. SIMILAR ref. 1906.19026 2997174 / 4817018 DX RH</p> <p>1906.19027 2997175 / 4817019 SX LH</p>
<p>AD ESAURIMENTO SCORTE UNTIL SELL-OUT</p> 	<p>ALZACRISTALLI ELETTRICO - CON MOTORINO - 2 FILI WINDOWS REGULATOR ELECTRIC - WITH MOTOR - 2 WIRES</p> <p>COS.PEL. ref. SIMILAR ref. 1906.19028 2997176 / 4817201 DX RH</p> <p>1906.19029 2997177 / 4817202 SX LH</p>



<p>AD ESAURIMENTO SCORTE UNTIL SPILL-OUT</p> 	<p>FRONTALE SUPERIORE METALLO - NERO FRONT PANEL STEEL - BLACK</p> <p>COS.PEL. ref. SIMILAR ref. 106.22470 4722470</p>
<p>AD ESAURIMENTO SCORTE UNTIL SPILL-OUT</p> 	<p>PUNTA PARAFANGO ANTERIORE R.I.M. - NERO FRONT MUDGUARD R.I.M. - BLACK</p> <p>COS.PEL. ref. SIMILAR ref. 206.24322 42324322 DX RH</p> <p>206.24321 42324321 SX LH</p>
<p>AD ESAURIMENTO SCORTE UNTIL SPILL-OUT</p> 	<p>PARAFANGO CORTO R.I.M. - NERO FRONT MUDGUARD R.I.M. - BLACK</p> <p>COS.PEL. ref. SIMILAR ref. 206.24323 42324330 SX LH</p>
<p>AD ESAURIMENTO SCORTE UNTIL SPILL-OUT</p> 	<p>ATTACCO PARAFANGO METALLO MUDGUARD BRACKET STEEL</p> <p>COS.PEL. ref. SIMILAR ref. 306.44030 4703771 DX RH</p> <p>306.44031 4703772 SX LH</p>



	<p>CORNICE PARABREZZA TETTO BASSO METALLO CABIN WINDSHIELD FRAME COMPLETE LOW CAB STEEL</p> <p>COS.PEL. ref. SIMILAR ref. 106.43890 8143416</p>
	<p>RIPAROFANGO POSTERIORE P.P.T. - GRIGIO REAR MUDGUARD P.P.T. - GREY</p> <p>COS.PEL. ref. SIMILAR ref. 206.00002 8144469</p> <p>206.00001 8144468</p> <p style="text-align: right;">DX RH SX LH</p>
	<p>PEDANA PARAFANGO S.M.C. - GRIGIO MUDGUARD FOOTSTEP S.M.C. - GREY</p> <p>COS.PEL. ref. SIMILAR ref. 206.44000 8144329</p> <p>206.44001 8144328</p> <p style="text-align: right;">DX RH SX LH</p> <p style="text-align: center;">Griglia/Grille : 1006.00008 Griglia/Grille : 1006.00008</p>
	<p>PROLUNGA PARAFANGO LATERALE CABINA CORTA - S.M.C. - GRIGIO EXTENSION MUDGUARD SHORT CAB - S.M.C. - GREY</p> <p>COS.PEL. ref. SIMILAR ref. 206.44002 8144315</p> <p>206.44003 8144314</p> <p style="text-align: right;">DX RH SX LH</p>
	<p>PROLUNGA PARAFANGO LATERALE CABINA LUNGA - S.M.C. - GRIGIO EXTENSION MUDGUARD LONG CAB - S.M.C. - GREY</p> <p>COS.PEL. ref. SIMILAR ref. 206.44004 8144318</p> <p>206.44005 8144317</p> <p style="text-align: right;">DX RH SX LH</p>

	<p>CALOTTA PARAFANGO POSTERIORE P.P. - GRIGIO REAR MUDGUARD P.P. - GREY</p> <p>COS.PEL. ref. SIMILAR ref. 206.02927 41002927 sx / 41003236 dx DX-SX RH-LH</p>
	<p>CALOTTA PARAFANGO POSTERIORE CON 4 TIRANTI P.P. - GRIGIO REAR MUDGUARD WITH 4 MUDGUARD TENSIONERS P.P. - GREY</p> <p>COS.PEL. ref. SIMILAR ref. 206.28251 2997165 / 41032399 / 42533556 / 42559051 DX-SX RH-LH (206.28254 versione senza i tiranti)</p>
	<p>CALOTTA PARAFANGO POSTERIORE CON 4 TIRANTI P.P. - GRIGIO REAR MUDGUARD RH-LH WITH 4 M. TENSIONERS P.P. - GREY</p> <p>COS.PEL. ref. SIMILAR ref. 206.28252 2997166 / 41032400 / 42533556 / 42559051 DX-SX RH-LH (206.28253 versione senza i tiranti)</p>
	<p>CALOTTA PARAFANGO POSTERIORE P.P. - GRIGIO REAR MUDGUARD P.P. - GREY</p> <p>COS.PEL. ref. SIMILAR ref. 206.28253 2997166 / 41032400 DX-SX RH-LH Relativo tirante 1001.00001 - (206.28252 versione con i tiranti)</p>
	<p>CALOTTA PARAFANGO POSTERIORE P.P. - GRIGIO REAR MUDGUARD P.P. - GREY</p> <p>COS.PEL. ref. SIMILAR ref. 206.28254 2997165 / 41032399 DX-SX RH-LH Relativo tirante 1001.00001 - (206.28251 versione con i tiranti)</p>
	<p>CALOTTA PARAFANGO POSTERIORE P.P. - GRIGIO REAR MUDGUARD P.P. - GREY</p> <p>COS.PEL. ref. SIMILAR ref. 206.28255 2997168 / 41032402 DX-SX RH-LH Relativo tirante 1001.00001 - (206.28258 versione con i tiranti)</p>
	<p>RIPARO CALOTTA P.P. - GRIGIO PROTECTION MUDGUARD P.P. - GREY</p> <p>COS.PEL. ref. SIMILAR ref. 206.28256 2997169 / 42533609 DX-SX RH-LH</p>
	<p>CALOTTA PARAFANGO POSTERIORE P.P. - GRIGIO REAR MUDGUARD P.P. - GREY</p> <p>COS.PEL. ref. SIMILAR ref. 206.28257 2997167 / 41032401 DX-SX RH-LH Relativo tirante 1001.00001 - (206.28259 versione con i tiranti)</p>







	<p>CALOTTA PARAFANGO POSTERIORE CON 4 TIRANTI P.P. - GRIGIO REAR MUDGUARD WITH 4 MUDGUARD TENSIONERS P.P. - GREY</p> <p>COS.PEL. ref. 206.28258 SIMILAR ref. 2997168 / 41032402 / 42533556 / 42559051 DX-SX RH-LH (206.28255 versione senza i tiranti)</p>
	<p>CALOTTA PARAFANGO POSTERIORE CON 4 TIRANTI P.P. - GRIGIO REAR MUDGUARD WITH 4 MUDGUARD TENSIONERS P.P. - GREY</p> <p>COS.PEL. ref. 206.28259 SIMILAR ref. 2997167 / 41032401 / 42533556 / 42559051 DX-SX RH-LH (206.28257 versione senza i tiranti)</p>
	<p>MEZZO PARAFANGO POSTERIORE / ANT P.P. - GRIGIO - CON STAFFE REAR MUDGUARD REAR / FRONT P.P. - GREY - WITH BRACKETS</p> <p>COS.PEL. ref. 206.28933 SIMILAR ref. 2997163 / 41032409 / 41032410 / 41032412 / 41032413 DX-SX RH-LH</p>
	<p>MEZZO PARAFANGO ANTERIORE / POST P.P. - GRIGIO - CON STAFFE MUDGUARD P.P. - GREY - CON STAFFE</p> <p>COS.PEL. ref. 206.28934 SIMILAR ref. 2997164 / 41032403 / 41032405 / 41032406 / 41032407 / 41210252 / 41210253 / 41210254 / 41210255 DX-SX RH-LH</p>
	<p>PEDANA S.M.C. - GRIGIO FOOTSTEP S.M.C. - GREY</p> <p>COS.PEL. ref. 306.05626 SIMILAR ref. 98429699 DX RH 306.05625 98429703 SX LH</p>
	<p>TAPPO PEDANA P.P. - GRIGIO COVER FOOTSTEP P.P. - GREY</p> <p>COS.PEL. ref. 306.05628 SIMILAR ref. - DX RH 306.05627 - SX LH</p>
	<p>RIPARO A.B.S. - GRIGIO ENGINE PROTECTION A.B.S. - GREY</p> <p>COS.PEL. ref. 306.79578 SIMILAR ref. 3798110 DX RH 306.79579 3798109 SX LH</p>
	<p>RIPARO A.B.S. - GRIGIO ENGINE PROTECTION A.B.S. - GREY</p> <p>COS.PEL. ref. 306.79580 SIMILAR ref. 3797997 DX RH 306.79581 3797996 SX LH</p>

	<p>RIPARO A.B.S. - GRIGIO ENGINE PROTECTION A.B.S. - GREY COS.PEL. ref. SIMILAR ref. 306.79582 3796975</p> <p>306.79583 3796974</p> <p style="text-align: right;">DX RH</p> <p style="text-align: right;">SX LH</p>
	<p>RIPARO A.B.S. - GRIGIO ENGINE PROTECTION A.B.S. - GREY COS.PEL. ref. SIMILAR ref. 306.79586 3797065</p> <p>306.79587 3797064</p> <p style="text-align: right;">DX RH</p> <p style="text-align: right;">SX LH</p>
	<p>PEDANA P.P.G.F. - GRIGIO FOOTSTEP P.P.G.F. - GREY COS.PEL. ref. SIMILAR ref. 306.05624 2997316 / 98417357</p> <p>306.05623 Griglia/Grille: 1006.00004 inf - 1006.00005 sup 2997317 / 98417358</p> <p style="text-align: right;">DX RH</p> <p style="text-align: right;">SX LH</p> <p style="text-align: center;">Griglia/Grille: 1006.00004 inf - 1006.00005 sup</p>
	<p>PARAURTI ANTERIORE P.P.G.F. - GRIGIO FRONT BUMPER P.P.G.F. - GREY COS.PEL. ref. SIMILAR ref. 406.43031 2997104 / 8143031</p>
	<p>PORTATARGA PARAURTI ANTERIORE S.M.C. - GRIGIO FRONT PLATE HOLDER S.M.C. - GREY COS.PEL. ref. SIMILAR ref. 406.43032 2997152 / 8143032</p>
	<p>PANNELLO CENTRALE PARAURTI S.M.C. - GRIGIO BUMPER COVERING S.M.C. - GREY COS.PEL. ref. SIMILAR ref. 406.43033 8143033 / 98499858</p>
	<p>TAPPO PARAURTI GRIGIO SCURO GRIGIO SCURO COVER BUMPER DARK GREY COS.PEL. ref. SIMILAR ref. 406.43034 98473849</p>
	<p>SPECCHIO RETROVISORE RISCALDATO - ELETTRICO REAR-VIEW MIRROR HEATED - ELECTRIC COS.PEL. ref. SIMILAR ref. 506.00000 98472983 / 98473011</p> <p style="text-align: right;">DX RH</p>

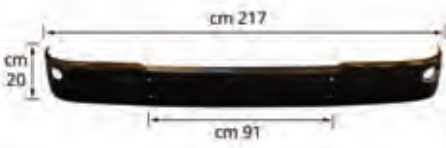
	<p>SPECCHIO RETROVISORE RISCALDATO - ELETTRICO REAR-VIEW MIRROR HEATED - ELECTRIC</p> <p>COS.PEL. ref. SIMILAR ref. 506.00001 98472979 / 98473007</p> <p style="text-align: right;">SX LH</p>
	<p>SPECCHIO RETROVISORE GRANDANGOLO - RISCALDATO - ELETTRICO - R 300 REAR-VIEW MIRROR WIDE ANGLE - HEATED - ELECTRIC - RADIUS 300</p> <p>COS.PEL. ref. SIMILAR ref. 506.00002 2996671 / 504132249</p> <p style="text-align: right;">DX-SX RH-LH</p>
	<p>VETRO SPECCHIO RISCALDATO - ATTACCO A GHIERA - (340x200mm) MIRROR GLASS HEATED - CAP COUPLING - (340x200mm)</p> <p>COS.PEL. ref. SIMILAR ref. 506.00003 93193197</p> <p style="text-align: right;">SX LH</p>
	<p>VETRO SPECCHIO RISCALDATO - ATTACCO A GHIERA - (440x200mm) MIRROR GLASS HEATED - CAP COUPLING - (440x200mm)</p> <p>COS.PEL. ref. SIMILAR ref. 506.00004 93193198</p> <p style="text-align: right;">DX RH</p>
	<p>VETRO SPECCHIO GRANDANGOLO - RISCALDATO - ATTACCO A GHIERA - (185x185mm) MIRROR GLASS WIDE ANGLE - HEATED - CAP COUPLING - (185x185mm)</p> <p>COS.PEL. ref. SIMILAR ref. 506.00005 42548403 / 93193199</p> <p style="text-align: right;">DX-SX RH-LH</p>
	<p>SPECCHIO RETROVISORE RISCALDATO - CORTO REAR-VIEW MIRROR HEATED - SHORT</p> <p>COS.PEL. ref. SIMILAR ref. 506.00009 98472977</p> <p style="text-align: right;">SX LH</p>
	<p>SPECCHIO RETROVISORE RISCALDATO - LUNGO REAR-VIEW MIRROR HEATED - LONG</p> <p>COS.PEL. ref. SIMILAR ref. 506.00010 98472982</p> <p style="text-align: right;">DX RH</p>
	<p>SPECCHIO RETROVISORE GRANDANGOLO - RISCALDATO - R300 REAR-VIEW MIRROR WIDE ANGLE - HEATED - R300</p> <p>COS.PEL. ref. SIMILAR ref. 506.00011 2996670 / 504132248 / 98472987</p>









	<p>SPECCHIO GUARDARUOTA ELETTRICO - RISCALDATO - RAGGIO 300 ROOF MIRROR ELECTRIC - HEATED - RADIUS 300</p> <p>COS.PEL. ref. SIMILAR ref. 506.00012 504132244 / 98472975</p>
	<p>SPECCHIO GUARDARUOTA RISCALDATO - RAGGIO 300 ROOF MIRROR HEATED - RADIUS 300</p> <p>COS.PEL. ref. SIMILAR ref. 506.00013 504132243 / 98472974</p>
	<p>VETRO SPECCHIO ATTACCO A MOLLA MIRROR GLASS SPRING ATTACK</p> <p>COS.PEL. ref. SIMILAR ref. 506.00016 93190976</p> <p style="text-align: right;">DX RH</p>
	<p>VETRO SPECCHIO ATTACCO A MOLLA MIRROR GLASS SPRING ATTACK</p> <p>COS.PEL. ref. SIMILAR ref. 506.00017 93190970</p> <p style="text-align: right;">SX LH</p>
	<p>VETRO SPECCHIO GRANDANGOLO - ATTACCO A MOLLA - R300 MIRROR GLASS WIDE ANGLE - SPRING ATTACK - R300</p> <p>COS.PEL. ref. SIMILAR ref. 506.00018 93190973</p>
	<p>COPERCHIO RETROVISORE A.B.S. - GRIGIO - (VITALONI) COVER MIRROR A.B.S. - GREY - (VITALONI)</p> <p>COS.PEL. ref. SIMILAR ref. 506.40215 93190971</p> <p style="text-align: right;">SX LH</p>
	<p>COPERCHIO RETROVISORE A.B.S. - GRIGIO - (VITALONI) COVER MIRROR A.B.S. - GREY - (VITALONI)</p> <p>COS.PEL. ref. SIMILAR ref. 506.40216 93190977</p> <p style="text-align: right;">DX RH</p>
	<p>COPERCHIO RETROVISORE GRANDANGOLO - A.B.S. - GRIGIO - (VITALONI) COVER MIRROR WIDE ANGLE - A.B.S. - GREY - (VITALONI)</p> <p>COS.PEL. ref. SIMILAR ref. 506.40217 93190974</p>

	<p>COPERCHIO RETROVISORE GRANDE A.B.S. - GRIGIO - (DONNELLY) COVER MIRROR A.B.S. - GREY - (DONNELLY)</p> <p>COS.PEL. ref. SIMILAR ref. 506.40218 93193161</p>
	<p>COPERCHIO RETROVISORE MEDIO A.B.S. - GRIGIO - (DONNELLY) COVER MIRROR A.B.S. - GREY - (DONNELLY)</p> <p>COS.PEL. ref. SIMILAR ref. 506.40219 2997156 / 93193202</p> <p>MEDIO</p>
	<p>COPERCHIO RETROVISORE GRANDANGOLO - A.B.S. - GRIGIO - (DONNELLY) COVER MIRROR WIDE ANGE - A.B.S. - GREY - (DONNELLY)</p> <p>COS.PEL. ref. SIMILAR ref. 506.40220 93193203 / 93193206</p> <p>DX RH</p>
	<p>SPECCHIO RETROVISORE NON RISCALDATO - CORTO REAR-VIEW MIRROR NOT HEATED - SHORT</p> <p>COS.PEL. ref. SIMILAR ref. 506.88886 98472976</p> <p>SX LH</p>
	<p>SPECCHIO RETROVISORE GRANDANGOLO - NON RISCALDATO - RAGGIO 300 REAR-VIEW MIRROR WIDE ANGLE - NOT HEATED - RADIUS 300</p> <p>COS.PEL. ref. SIMILAR ref. 506.88887 504076983 / 98472986 / 98473012</p> <p>SX LH</p>
	<p>SPECCHIO RETROVISORE NON RISCALDATO - LUNGO REAR-VIEW MIRROR NOT HEATED - LONG</p> <p>COS.PEL. ref. SIMILAR ref. 506.88888 98472981 / 98473008</p> <p>DX RH</p>
 <p>cm 219,5 cm 21,5 cm 70</p>	<p>VISIERA TETTO BASSO TETTO BASSO - FORI RETTANGOLARI SUN VISOR LOW CAB LOW CAB - RECTANGULAR HOLES</p> <p>COS.PEL. ref. SIMILAR ref. 706.43400 2995676 / 93162831</p> <p>Solo foro rettangolare - Relativo kit staffe 1006.43400</p>
 <p>cm 220,5 cm 21,5 cm 92</p>	<p>VISIERA FORI RETTANGOLARI SUN VISOR RECTANGULAR HOLES</p> <p>COS.PEL. ref. SIMILAR ref. 706.43401 500337805</p> <p>Solo foro rettangolare - Relativo kit staffe 1006.43401</p>

	<p>VISIERA FORI OVALI SUN VISOR OVAL HOLES</p> <p>COS.PEL. ref. 706.43402 SIMILAR ref. 504107220</p> <p>Relativo kit staffe 1006.43401</p>
	<p>TASSELLO PARAURTI IN GOMMA GOMMA MOUNTING RUBBER RUBBER</p> <p>COS.PEL. ref. 1006.00002 SIMILAR ref. 98452368</p>
	<p>STAFFA TASSELLO PARAURTI AMMORTIZZANTE - METALLO BRACKET FOR MOUNTING RUBBER STEEL</p> <p>COS.PEL. ref. 1006.00003 SIMILAR ref. 98452333</p>
	<p>GRIGLIA PEDANA INFERIORE ALLUMINIO LOWER FOOTSTEP GRILLE ALUMINIUM</p> <p>COS.PEL. ref. 1006.00004 SIMILAR ref. 3798584 / 8142611</p> <p style="text-align: right;">DX-SX RH-LH</p>
	<p>GRIGLIA PEDANA CENTRALE ALLUMINIO CENTRE FOOTSTEP GRILLE ALUMINIUM</p> <p>COS.PEL. ref. 1006.00005 SIMILAR ref. 3798585 / 8142610</p> <p style="text-align: right;">DX-SX RH-LH</p>
	<p>GRIGLIA PARAURTI ALLUMINIO BUMPER GRILLE ALUMINIUM</p> <p>COS.PEL. ref. 1006.00006 SIMILAR ref. 3798587</p>
	<p>GRIGLIA PEDANA ALLUMINIO FOOTSTEP GRILLE ALUMINIUM</p> <p>COS.PEL. ref. 1006.00008 SIMILAR ref. 3798586 / 8142607</p> <p style="text-align: right;">DX-SX RH-LH</p>
	<p>TAPPO PARAFANGO GRIGIO SCURO COVER MUDGUARD DARK GREY</p> <p>COS.PEL. ref. 1006.28934 SIMILAR ref. 42533495 / 42559052</p>

	<p>COLLARE DI FISSAGGIO PARAFANGO METALLO BRACKET MUDGUARD METAL</p> <p>COS.PEL. ref. SIMILAR ref. 1006.33602 42559053</p>
	<p>FORCELLA ALZACRISTALLI WINDOW REGULATOR CLIP</p> <p>COS.PEL. ref. SIMILAR ref. 1006.60029 2997187 / 98416236</p>
 	<p>FANALINO CORNER LAMP</p> <p>COS.PEL. ref. SIMILAR ref. 1606.36360 98460036 DX RH</p> <p>1606.36361 98460038 SX LH</p>
 	<p>FANALINO PEDANA LATERALE SIDE LAMP FOOTSTEP</p> <p>COS.PEL. ref. SIMILAR ref. 1606.36362 98419235 DX RH</p> <p>1606.36363 98419234 SX LH</p>
 	<p>FANALINO PEDANA LATERALE SIDE LAMP FOOTSTEP</p> <p>COS.PEL. ref. SIMILAR ref. 1606.36364 500368110 DX RH</p> <p>1606.36365 500368111 SX LH</p>
 	<p>FANALINO VISIERA NERO - 91 -> SUN VISOR'S MARKER BLACK - 91 -></p> <p>COS.PEL. ref. SIMILAR ref. 1606.75920 500314717 DX RH</p> <p>1606.75921 500314716 SX LH</p>
 	<p>FANALINO VISIERA ARGENTO - 91 -> SUN VISOR'S MARKER SILVER - 91 -></p> <p>COS.PEL. ref. SIMILAR ref. 1606.75922 98461649 DX RH</p> <p>1606.75923 98461648 SX LH</p>
 	<p>PROIETTORE H4 H3 - PREDISPOSTO PER CORRETTORE ASSETTO HEADLAMP H4 H3 - SUITABLE FOR LOAD LEVEL ADJUSTEMENT</p> <p>COS.PEL. ref. SIMILAR ref. 1606.05102 500305102 DX RH</p> <p>1606.05103 500305103 SX LH</p>

	<p>PROIETTORE H3 H4 - CORRETTORE ASSETTO MANUALE HEADLAMP H3 H4 - MANUAL LOAD LEVEL ADJUSTEMENT COS.PEL. ref. SIMILAR ref. 1606.48440 4861793</p> <p>1606.48441 4861794</p> <p style="text-align: right;">DX RH</p> <p style="text-align: right;">SX LH</p>
	<p>FENDINEBBIA H3 FOG LAMP H3 COS.PEL. ref. SIMILAR ref. 1606.60110 98437475</p> <p>1606.60111 98437476</p> <p style="text-align: right;">DX RH</p> <p style="text-align: right;">SX LH</p>
	<p>MANIGLIA PORTA NERO - CON CHIAVE DOOR HANDLE BLACK - WITH KEY COS.PEL. ref. SIMILAR ref. 1706.60900 98404709</p> <p>1706.60901 98404710</p> <p style="text-align: right;">DX RH</p> <p style="text-align: right;">SX LH</p>
	<p>KIT MANIGLIE PORTE NERO - CON CHIAVI DOOR HANDLE KIT BLACK - WITH KEYS COS.PEL. ref. SIMILAR ref. 1706.60902 500335296 / 98404714</p> <p style="text-align: right;">DX-SX RH-LH</p>
	<p>SERRATURA PORTA ELETTRICA ELECTRIC DOOR LOCK COS.PEL. ref. SIMILAR ref. 1706.60906 98411951 / 98416419</p> <p>1706.60905 98411952 / 98416424</p> <p style="text-align: right;">DX RH</p> <p style="text-align: right;">SX LH</p>
	<p>ARRESTO PORTA DOOR STOP COS.PEL. ref. SIMILAR ref. 1706.60908 5802132946 / 99476267</p> <p>1706.60907 5802132944 / 99476268</p> <p style="text-align: right;">DX RH</p> <p style="text-align: right;">SX LH</p>
	<p>GUARNIZIONE PARABREZZA WINDSCREEN GASKET COS.PEL. ref. SIMILAR ref. 1806.24015 8143852</p>
	<p>RASCHIAVETRO ESTERNO GLASS GUIDE WEATHER STRIP COS.PEL. ref. SIMILAR ref. 1806.60122 8142800</p> <p>1806.60121 8142799</p> <p style="text-align: right;">DX RH</p> <p style="text-align: right;">SX LH</p>

	<p>RASCHIAVETRO INTERNO GLASS GUIDE WEATHER STRIP</p> <p>COS.PEL. ref. SIMILAR ref. 1806.60124 98408394 DX RH</p> <p>1806.60123 98408393 SX LH</p>
	<p>GUARNIZIONE GIROVETRO SX UPPER FRAME WEATHER STRIP</p> <p>COS.PEL. ref. SIMILAR ref. 1806.60126 8142802 DX RH</p> <p>1806.60125 8142801 SX LH</p>
	<p>GUARNIZIONE VETRO FISSO GLASS RUBBER SEAL</p> <p>COS.PEL. ref. SIMILAR ref. 1806.60128 98409362 DX RH</p> <p>1806.60127 98409363 SX LH</p>
	<p>TRAFILATO PSL VANO PORTA ROTTOLI MT. 25 DOOR OPENING WEATHER STRIP ROLLS MT. 25</p> <p>COS.PEL. ref. SIMILAR ref. 1806.60131 99477139</p>
	<p>TRAFILATO PSL VANO PORTA SPEZZONE MT. 4,5 DOOR OPENING WEATHER STRIP PIECE LINGHT MT.4,5</p> <p>COS.PEL. ref. SIMILAR ref. 1806.60132 8142404</p>
	<p>GUIDA VETRO WINDOW FRAME</p> <p>COS.PEL. ref. SIMILAR ref. 1806.60134 98484152 DX RH</p> <p>1806.60133 98404902 SX LH</p>
	<p>ALZACRISTALLI MANUALE WINDOW REGULATOR MANUAL</p> <p>COS.PEL. ref. SIMILAR ref. 1906.60030 2997185 / 98407741 DX RH</p> <p>1906.60031 2997186 / 98407744 SX LH</p>
	<p>ALZACRISTALLI ELETTRICO - CON MOTORINO - 2 PIN WINDOW REGULATOR ELECTRIC - WITH MOTOR - 2 PIN</p> <p>COS.PEL. ref. SIMILAR ref. 1906.60032 2997195 / 98407721 / 99487780 DX RH</p> <p>1906.60033 2997196 / 98407722 / 99487781 SX LH</p>

ALL ITEMS MENTIONED IN OUR CATALOGUE ARE NOT ORIGINAL PARTS BUT PERFECTLY INTERCHANGEABLE WITH THEM.

GOVERNING LEGISLATIONS FOR THE SALE OF OUR PRODUCTS DIFFER IN EACH COUNTRY.

INFRINGEMENTS, IF ANY, OF LOCAL LEGISLATIONS ARE RESPONSIBILITY OF THE RETAILER IN THE COUNTRY OF FINAL DISTRIBUTION.



	<p>SERBATOIO LAVACRISTALLI TANK</p> <p>COS.PEL. ref. 2106.43080 SIMILAR ref. 98409491</p>
	<p>TIRANTE PARAFANGO POSTERIORE GOMMA - NERO MUDGUARD TENSIONER RUBBER - BLACK</p> <p>COS.PEL. ref. 1001.00001 SIMILAR ref. 42533556 / 42559051</p>
	<p>TIRANTE COPRI BATTERIA CORTO 140 mm MUDGUARD TENSIONER SHORT 140 mm</p> <p>COS.PEL. ref. 1006.90107 SIMILAR ref. 4605163</p>
	<p>TIRANTE COPRI BATTERIA LUNGO 144 mm MUDGUARD TENSIONER LONG 144 mm</p> <p>COS.PEL. ref. 1006.90109 SIMILAR ref. 4784894</p>
	<p>MOLLA A GAS Lunghezza [mm] 760 Corsa [mm] 310 Forza scarto [N] 210 GAS SPRING Lenght [mm] 760 Stroke [mm] 310 Waste force [N] 210</p> <p>COS.PEL. ref. 2406.36100 SIMILAR ref. 98476371</p>
	<p>DEFLETTORI LATERALI CON CLIPS SIDEWINDOW DEFLECTORS WITH CLIPS</p> <p>COS.PEL. ref. 3006.00000 SIMILAR ref. -</p>
	<p>PROTEZIONE FARO Per Cos.Ive Eurotech GRID For Cos.Ive Eurotech</p> <p>COS.PEL. ref. 2000.00012 SIMILAR ref. -</p>
	<p>ANELLO COPRIMOZZO 10 FORI 10 FORI - PLASTICA - GRIGIO - DIAMETRO 22mm RING WHEEL COVER 10 HOLES 10 HOLES - PLASTIC - GREY - DIAMETER 22mm</p> <p>COS.PEL. ref. 2000.00211 SIMILAR ref. 41027910</p> <p>Ordinabile solo per conf. di 2 pz. / Sold by package of 2 pcs.</p>

	<p>ANELLO COPRIMOZZO 10 FORI 10 FORI - PLASTICA - GRIGIO - DIAMETRO 32mm RING WHEEL COVER 10 HOLES 10 FORI - PLASTIC - GREY - DIAMETER 32mm</p> <p>COS.PEL. ref. SIMILAR ref. 2000.00213 41032687</p> <p>Ordinabile solo per conf. di 2 pz. / Sold by package of 2 pcs.</p>
	<p>ANELLO COPRIMOZZO 10 FORI 10 FORI - ACCIAIO INOX RING WHEEL COVER 10 HOLES 10 HOLES - STAINLESS STEEL</p> <p>COS.PEL. ref. SIMILAR ref. 2000.00216 -</p> <p>Ordinabile solo per conf. di 2 pz. / Sold by package of 2 pcs.</p>
	<p>COPPA COPRIMOZZO 10 FORI 10 FORI - ACCIAIO INOX WHEEL COVER 10 HOLES 10 HOLES - STAINLESS STEEL</p> <p>COS.PEL. ref. SIMILAR ref. 2000.00252 -</p> <p>Ordinabile solo per conf. di 2 pz. / Sold by package of 2 pcs.</p>
	<p>FANALE POSTERIORE 7 FUNZIONI - SENZA LUCE TARGA REAR-LIGHT 7 FUNCTIONS - W/O PLATE LIGHT</p> <p>COS.PEL. ref. SIMILAR ref. 006140 -</p> <p>006150 -</p> <p>TRASPARENTE / LENS Relativo connettore 003105</p> <p>011111 -</p> <p style="text-align: right;">DX RH SX LH DX-SX RH-LH</p>
	<p>FANALE POSTERIORE 7 FUNZIONI - SENZA L. TARGA - CON BORDO BIANCO REAR-LIGHT 7 FUNCTIONS - W/O PLATE LIGHT - WITH WHITE EDGE</p> <p>COS.PEL. ref. SIMILAR ref. 006142 99463242</p> <p>006141 Relativo connettore 003105 99463243</p> <p>TRASPARENTE / LENS Relativo connettore 003105</p> <p>011110 93161844</p> <p style="text-align: right;">DX RH SX LH DX-SX RH-LH</p>
	<p>FANALE POSTERIORE 7 FUNZIONI - CON LUCE TARGA - CON BORDO BIANCO REAR-LIGHT 7 FUNCTIONS - WITH PLATE LIGHT - WITH WHITE EDGE</p> <p>COS.PEL. ref. SIMILAR ref. 006143 99463244</p> <p> Con luce targa / With plate light - conn. 003105</p> <p>TRASPARENTE / LENS</p> <p>011110 93161844</p> <p style="text-align: right;">SX LH DX-SX RH-LH</p>
	<p>FANALE POSTERIORE LED REAR-LIGHT LED</p> <p>COS.PEL. ref. SIMILAR ref. 006152 -</p> <p>006151 Relativo connettore 003105</p> <p>TRASPARENTE / LENS Con luce targa / With plate light - conn. 003105</p> <p>011112 -</p> <p style="text-align: right;">DX RH SX LH DX-SX RH-LH</p>
	<p>FANALE POSTERIORE 7 FUNZIONI - CON LUCE TARGA REAR-LIGHT 7 FUNCTIONS - WITH PLATE LIGHT</p> <p>COS.PEL. ref. SIMILAR ref. 006880 -</p> <p> Relativo connettore 003105</p> <p>TRASPARENTE / LENS</p> <p>011111 -</p> <p style="text-align: right;">SX LH DX-SX RH-LH</p>

COS.IVE



	<p>RIPAROFANGO POSTERIORE P.P.T. - GRIGIO REAR MUDGUARD P.P.T. - GREY</p> <p>COS.PEL. ref. SIMILAR ref. 206.00002 8144469</p> <p>206.00001 8144468</p> <p style="text-align: right;">DX RH</p> <p style="text-align: right;">SX LH</p>
	<p>PEDANA PARAFANGO S.M.C. - GRIGIO MUDGUARD FOOTSTEP S.M.C. - GREY</p> <p>COS.PEL. ref. SIMILAR ref. 206.42028 98442028</p> <p>206.42029 98442029</p> <p style="text-align: right;">DX RH</p> <p style="text-align: right;">SX LH</p> <p style="text-align: center;">Griglia/Grille : 1006.00005 Griglia/Grille : 1006.00005</p>
	<p>CALOTTA PARAFANGO POSTERIORE P.P. - GRIGIO REAR MUDGUARD P.P. - GREY</p> <p>COS.PEL. ref. SIMILAR ref. 206.02927 41002927 sx / 41003236 dx</p> <p style="text-align: right;">DX-SX RH-LH</p>
	<p>CALOTTA PARAFANGO POSTERIORE CON 4 TIRANTI P.P. - GRIGIO REAR MUDGUARD WITH 4 MUDGUARD TENSIONERS P.P. - GREY</p> <p>COS.PEL. ref. SIMILAR ref. 206.28251 2997165 / 41032399 / 42533556 / 42559051</p> <p style="text-align: right;">DX-SX RH-LH</p> <p style="text-align: center;">(206.28254 versione senza i tiranti)</p>
	<p>CALOTTA PARAFANGO POSTERIORE CON 4 TIRANTI P.P. - GRIGIO REAR MUDGUARD RH-LH WITH 4 M. TENSIONERS P.P. - GREY</p> <p>COS.PEL. ref. SIMILAR ref. 206.28252 2997166 / 41032400 / 42533556 / 42559051</p> <p style="text-align: right;">DX-SX RH-LH</p> <p style="text-align: center;">(206.28253 versione senza i tiranti)</p>

	<p>CALOTTA PARAFANGO POSTERIORE P.P. - GRIGIO REAR MUDGUARD P.P. - GREY</p> <p>COS.PEL. ref. 206.28253 SIMILAR ref. 2997166 / 41032400 DX-SX RH-LH</p> <p>Relativo tirante 1001.00001 - (206.28252 versione con i tiranti)</p>
	<p>CALOTTA PARAFANGO POSTERIORE P.P. - GRIGIO REAR MUDGUARD P.P. - GREY</p> <p>COS.PEL. ref. 206.28254 SIMILAR ref. 2997165 / 41032399 DX-SX RH-LH</p> <p>Relativo tirante 1001.00001 - (206.28251 versione con i tiranti)</p>
	<p>CALOTTA PARAFANGO POSTERIORE P.P. - GRIGIO REAR MUDGUARD P.P. - GREY</p> <p>COS.PEL. ref. 206.28255 SIMILAR ref. 2997168 / 41032402 DX-SX RH-LH</p> <p>Relativo tirante 1001.00001 - (206.28258 versione con i tiranti)</p>
	<p>RIPARO CALOTTA P.P. - GRIGIO PROTECTION MUDGUARD P.P. - GREY</p> <p>COS.PEL. ref. 206.28256 SIMILAR ref. 2997169 / 42533609 DX-SX RH-LH</p>
	<p>CALOTTA PARAFANGO POSTERIORE P.P. - GRIGIO REAR MUDGUARD P.P. - GREY</p> <p>COS.PEL. ref. 206.28257 SIMILAR ref. 2997167 / 41032401 DX-SX RH-LH</p> <p>Relativo tirante 1001.00001 - (206.28259 versione con i tiranti)</p>
	<p>CALOTTA PARAFANGO POSTERIORE CON 4 TIRANTI P.P. - GRIGIO REAR MUDGUARD WITH 4 MUDGUARD TENSIONERS P.P. - GREY</p> <p>COS.PEL. ref. 206.28258 SIMILAR ref. 2997168 / 41032402 / 42533556 / 42559051 DX-SX RH-LH (206.28255 versione senza i tiranti)</p>
	<p>CALOTTA PARAFANGO POSTERIORE CON 4 TIRANTI P.P. - GRIGIO REAR MUDGUARD WITH 4 MUDGUARD TENSIONERS P.P. - GREY</p> <p>COS.PEL. ref. 206.28259 SIMILAR ref. 2997167 / 41032401 / 42533556 / 42559051 DX-SX RH-LH (206.28257 versione senza i tiranti)</p>
	<p>MEZZO PARAFANGO POSTERIORE / ANT P.P. - GRIGIO - CON STAFFE REAR MUDGUARD REAR / FRONT P.P. - GREY - WITH BRACKETS</p> <p>COS.PEL. ref. 206.28933 SIMILAR ref. 2997163 / 41032409 / 41032410 / 41032412 / 41032413 DX-SX RH-LH</p>

 <p>cm 67 cm 60 cm 21</p>	<p>MEZZO PARAFANGO ANTERIORE / POST P.P. - GRIGIO - CON STAFFE MUDGUARD P.P. - GREY - CON STAFFE</p> <p>COS.PEL. ref. SIMILAR ref. 206.28934 2997164 / 41032403 / 41032405 / 41032406 / 41032407 / 41210252 / 41210253 / 41210254 / 41210255 DX-SX RH-LH</p>
	<p>RIPARO PEDANA S.M.C. - GRIGIO FOOTSTEP S.M.C. - GREY</p> <p>COS.PEL. ref. SIMILAR ref. 306.05560 98405560 DX RH</p> <p>306.05561 98405561 SX LH</p>
	<p>RIPARO A.B.S. - GRIGIO ENGINE PROTECTION A.B.S. - GREY</p> <p>COS.PEL. ref. SIMILAR ref. 306.79580 3797997 DX RH</p> <p>306.79581 3797996 SX LH</p>
	<p>RIPARO A.B.S. - GRIGIO ENGINE PROTECTION A.B.S. - GREY</p> <p>COS.PEL. ref. SIMILAR ref. 306.79582 3796975 DX RH</p> <p>306.79583 3796974 SX LH</p>
	<p>RIPARO A.B.S. - GRIGIO ENGINE PROTECTION A.B.S. - GREY</p> <p>COS.PEL. ref. SIMILAR ref. 306.79584 3798826 DX RH</p> <p>306.79585 37988602 SX LH</p>
	<p>RIPARO A.B.S. - GRIGIO ENGINE PROTECTION A.B.S. - GREY</p> <p>COS.PEL. ref. SIMILAR ref. 306.79588 3798409 DX-SX RH-LH</p>
	<p>RIPARO A.B.S. - GRIGIO ENGINE PROTECTION A.B.S. - GREY</p> <p>COS.PEL. ref. SIMILAR ref. 306.79589 3798408 DX-SX RH-LH</p>
 <p>cm 57 cm 18,5</p>	<p>PEDANA P.P.G.F. - GRIGIO FOOTSTEP P.P.G.F. - GREY</p> <p>COS.PEL. ref. SIMILAR ref. 306.05622 2997318 / 98438466 DX RH</p> <p>306.05621 Griglia/Grille: 1006.00004 inf - 1006.00005 sup 2997319 / 98438467 SX LH</p> <p>Griglia/Grille: 1006.00004 inf - 1006.00005 sup</p>

	<p>CANTONALE PARAURTI P.C.+A.B.S. - GRIGIO CORNER BUMPER P.C.+A.B.S. - GREY COS.PEL. ref. SIMILAR ref. 406.05628 500389854 DX RH</p> <p>406.05627 500389853 SX LH</p>
 <p>cm 68,5</p>	<p>PARAURTI ANTERIORE P.P.G.F. - GRIGIO FRONT BUMPER P.P.G.F. - GREY COS.PEL. ref. SIMILAR ref. 406.38450 2997105 / 98438450</p>
	<p>PORTATARGA PARAURTI ANTERIORE S.M.C. - GRIGIO FRONT PLATE HOLDER S.M.C. - GREY COS.PEL. ref. SIMILAR ref. 406.43032 2997152 / 8143032</p>
	<p>PANNELLO CENTRALE PARAURTI S.M.C. - GRIGIO BUMPER COVERING S.M.C. - GREY COS.PEL. ref. SIMILAR ref. 406.43033 8143033 / 98499858</p>
	<p>TAPPO PARAURTI GRIGIO SCURO GRIGIO SCURO COVER BUMPER DARK GREY COS.PEL. ref. SIMILAR ref. 406.43034 98473849</p>
	<p>SPECCHIO RETROVISORE RISCALDATO - ELETTRICO REAR-VIEW MIRROR HEATED - ELECTRIC COS.PEL. ref. SIMILAR ref. 506.00000 98472983 / 98473011 DX RH</p>
	<p>SPECCHIO RETROVISORE RISCALDATO - ELETTRICO REAR-VIEW MIRROR HEATED - ELECTRIC COS.PEL. ref. SIMILAR ref. 506.00001 98472979 / 98473007 SX LH</p>
	<p>SPECCHIO RETROVISORE GRANDANGOLO - RISCALDATO - ELETTRICO - R 300 REAR-VIEW MIRROR WIDE ANGLE - HEATED - ELECTRIC - RADIUS 300 COS.PEL. ref. SIMILAR ref. 506.00002 2996671 / 504132249 DX-SX RH-LH</p>

	<p>VETRO SPECCHIO RISCALDATO - ATTACCO A GHIERA - (340x200mm) MIRROR GLASS HEATED - CAP COUPLING - (340x200mm)</p> <p>COS.PEL. ref. SIMILAR ref. 506.00003 93193197</p> <p style="text-align: right;">SX LH</p>
	<p>VETRO SPECCHIO RISCALDATO - ATTACCO A GHIERA - (440x200mm) MIRROR GLASS HEATED - CAP COUPLING - (440x200mm)</p> <p>COS.PEL. ref. SIMILAR ref. 506.00004 93193198</p> <p style="text-align: right;">DX RH</p>
	<p>VETRO SPECCHIO GRANDANGOLO - RISCALDATO - ATTACCO A GHIERA - (185x185mm) MIRROR GLASS WIDE ANGLE - HEATED - CAP COUPLING - (185x185mm)</p> <p>COS.PEL. ref. SIMILAR ref. 506.00005 42548403 / 93193199</p> <p style="text-align: right;">DX-SX RH-LH</p>
	<p>SPECCHIO RETROVISORE RISCALDATO - CORTO REAR-VIEW MIRROR HEATED - SHORT</p> <p>COS.PEL. ref. SIMILAR ref. 506.00009 98472977</p> <p style="text-align: right;">SX LH</p>
	<p>SPECCHIO RETROVISORE RISCALDATO - LUNGO REAR-VIEW MIRROR HEATED - LONG</p> <p>COS.PEL. ref. SIMILAR ref. 506.00010 98472982</p> <p style="text-align: right;">DX RH</p>
	<p>SPECCHIO RETROVISORE GRANDANGOLO - RISCALDATO - R300 REAR-VIEW MIRROR WIDE ANGLE - HEATED - R300</p> <p>COS.PEL. ref. SIMILAR ref. 506.00011 2996670 / 504132248 / 98472987</p>
	<p>SPECCHIO GUARDARUOTA ELETTRICO - RISCALDATO - RAGGIO 300 ROOF MIRROR ELECTRIC - HEATED - RADIUS 300</p> <p>COS.PEL. ref. SIMILAR ref. 506.00012 504132244 / 98472975</p>
	<p>SPECCHIO GUARDARUOTA RISCALDATO - RAGGIO 300 ROOF MIRROR HEATED - RADIUS 300</p> <p>COS.PEL. ref. SIMILAR ref. 506.00013 504132243 / 98472974</p>

	<p>VETRO SPECCHIO ATTACCO A MOLLA MIRROR GLASS SPRING ATTACK</p> <p>COS.PEL. ref. SIMILAR ref. 506.00016 93190976</p> <p style="text-align: right;">DX RH</p>
	<p>VETRO SPECCHIO ATTACCO A MOLLA MIRROR GLASS SPRING ATTACK</p> <p>COS.PEL. ref. SIMILAR ref. 506.00017 93190970</p> <p style="text-align: right;">SX LH</p>
	<p>VETRO SPECCHIO GRANDANGOLO - ATTACCO A MOLLA - R300 MIRROR GLASS WIDE ANGLE - SPRING ATTACK - R300</p> <p>COS.PEL. ref. SIMILAR ref. 506.00018 93190973</p>
	<p>COPERCHIO RETROVISORE A.B.S. - GRIGIO - (VITALONI) COVER MIRROR A.B.S. - GREY - (VITALONI)</p> <p>COS.PEL. ref. SIMILAR ref. 506.40215 93190971</p> <p style="text-align: right;">SX LH</p>
	<p>COPERCHIO RETROVISORE A.B.S. - GRIGIO - (VITALONI) COVER MIRROR A.B.S. - GREY - (VITALONI)</p> <p>COS.PEL. ref. SIMILAR ref. 506.40216 93190977</p> <p style="text-align: right;">DX RH</p>
	<p>COPERCHIO RETROVISORE GRANDANGOLO - A.B.S. - GRIGIO - (VITALONI) COVER MIRROR WIDE ANGLE - A.B.S. - GREY - (VITALONI)</p> <p>COS.PEL. ref. SIMILAR ref. 506.40217 93190974</p>
	<p>COPERCHIO RETROVISORE GRANDE A.B.S. - GRIGIO - (DONNELLY) COVER MIRROR A.B.S. - GREY - (DONNELLY)</p> <p>COS.PEL. ref. SIMILAR ref. 506.40218 93193161</p>
	<p>COPERCHIO RETROVISORE MEDIO A.B.S. - GRIGIO - (DONNELLY) COVER MIRROR A.B.S. - GREY - (DONNELLY)</p> <p>COS.PEL. ref. SIMILAR ref. 506.40219 2997156 / 93193202</p> <p style="text-align: center;">MEDIO</p>

	<p>COPERCHIO RETROVISORE GRANDANGOLO - A.B.S. - GRIGIO - (DONNELLY) COVER MIRROR WIDE ANGE - A.B.S. - GREY - (DONNELLY)</p> <p>COS.PEL. ref. 506.40220 SIMILAR ref. 93193203 / 93193206</p> <p style="text-align: right;">DX RH</p>
	<p>SPECCHIO RETROVISORE NON RISCALDATO - CORTO REAR-VIEW MIRROR NOT HEATED - SHORT</p> <p>COS.PEL. ref. 506.88886 SIMILAR ref. 98472976</p> <p style="text-align: right;">SX LH</p>
	<p>SPECCHIO RETROVISORE GRANDANGOLO - NON RISCALDATO - RAGGIO 300 REAR-VIEW MIRROR WIDE ANGLE - NOT HEATED - RADIUS 300</p> <p>COS.PEL. ref. 506.88887 SIMILAR ref. 504076983 / 98472986 / 98473012</p> <p style="text-align: right;">SX LH</p>
	<p>SPECCHIO RETROVISORE NON RISCALDATO - LUNGO REAR-VIEW MIRROR NOT HEATED - LONG</p> <p>COS.PEL. ref. 506.88888 SIMILAR ref. 98472981 / 98473008</p> <p style="text-align: right;">DX RH</p>
	<p>VISIERA SUN VISOR</p> <p>COS.PEL. ref. 706.38500 SIMILAR ref. 504107239</p> <p>Solo foro rettangolare - Relativo kit staffe 1006.38500</p>
	<p>VISIERA U.T. SUN VISOR U.T.</p> <p>COS.PEL. ref. 706.38501 SIMILAR ref. 2995675</p> <p>Solo foro rettangolare - Relativo kit staffe 1006.43401</p>
	<p>TASSELLO PARAURTI IN GOMMA GOMMA MOUNTING RUBBER RUBBER</p> <p>COS.PEL. ref. 1006.00002 SIMILAR ref. 98452368</p>
	<p>STAFFA TASSELLO PARAURTI AMMORTIZZANTE - METALLO BRACKET FOR MOUNTING RUBBER STEEL</p> <p>COS.PEL. ref. 1006.00003 SIMILAR ref. 98452333</p>

	<p>GRIGLIA PEDANA INFERIORE ALLUMINIO LOWER FOOTSTEP GRILLE ALUMINIUM</p> <p>COS.PEL. ref. SIMILAR ref. 1006.00004 3798584 / 8142611</p> <p style="text-align: right;">DX-SX RH-LH</p>
	<p>GRIGLIA PEDANA CENTRALE ALLUMINIO CENTRE FOOTSTEP GRILLE ALUMINIUM</p> <p>COS.PEL. ref. SIMILAR ref. 1006.00005 3798585 / 8142610</p> <p style="text-align: right;">DX-SX RH-LH</p>
	<p>GRIGLIA PARAURTI ALLUMINIO BUMPER GRILLE ALUMINIUM</p> <p>COS.PEL. ref. SIMILAR ref. 1006.00006 3798587</p>
	<p>GRIGLIA PEDANA ALLUMINIO FOOTSTEP GRILLE ALUMINIUM</p> <p>COS.PEL. ref. SIMILAR ref. 1006.00008 3798586 / 8142607</p> <p style="text-align: right;">DX-SX RH-LH</p>
	<p>SUPPORTO FARO POSTERIORE METALLO REAR-LIGHT BRACKET METAL</p> <p>COS.PEL. ref. SIMILAR ref. 1006.10241 41032513 / 41210241 / 42559148</p>
	<p>TAPPO PARAFANGO GRIGIO SCURO COVER MUDGUARD DARK GREY</p> <p>COS.PEL. ref. SIMILAR ref. 1006.28934 42533495 / 42559052</p>
	<p>FORCELLA ALZACRISTALLI WINDOW REGULATOR CLIP</p> <p>COS.PEL. ref. SIMILAR ref. 1006.60029 2997187 / 98416236</p>
	<p>CANTONALE S.M.C. - GRIGIO CORNER PANEL S.M.C. - GREY</p> <p>COS.PEL. ref. SIMILAR ref. 1206.42428 8142428</p> <p style="text-align: right;">DX RH</p> <p>1206.42427 8142427</p> <p style="text-align: right;">SX LH</p>

ALL ITEMS MENTIONED IN OUR CATALOGUE ARE NOT ORIGINAL PARTS BUT PERFECTLY INTERCHANGEABLE WITH THEM.

GOVERNING LEGISLATIONS FOR THE SALE OF OUR PRODUCTS DIFFER IN EACH COUNTRY.

INFRINGEMENTS, IF ANY, OF LOCAL LEGISLATIONS ARE RESPONSIBILITY OF THE RETAILER IN THE COUNTRY OF FINAL DISTRIBUTION.



<p>AD ESAURIMENTO SCORTE UNTIL SELL-OUT</p> 	<p>PORTA METALLO DOOR METAL</p> <p>COS.PEL. ref. SIMILAR ref. 1406.04802 1908809 / 504232501</p> <p>1406.04803 1908810 / 504232504</p> <p style="text-align: right;">DX RH</p> <p style="text-align: right;">SX LH</p>
	<p>SOTTOPORTA S.M.C. - GRIGIO EXTENSION DOOR S.M.C. - GREY</p> <p>COS.PEL. ref. SIMILAR ref. 1406.96754 500396754</p> <p>1406.96753 500396753</p> <p style="text-align: right;">DX RH</p> <p style="text-align: right;">SX LH</p>
	<p>RIVESTIMENTO INTERNO PROLUNGA PORTA A.B.S. - NERO INNER PANEL DOOR EXTENSION A.B.S. - BLACK</p> <p>COS.PEL. ref. SIMILAR ref. 1406.96756 3799163</p> <p>1406.96755 3799162</p> <p style="text-align: right;">DX RH</p> <p style="text-align: right;">SX LH</p>
 	<p>FANALINO PEDANA LATERALE SIDE LAMP FOOTSTEP</p> <p>COS.PEL. ref. SIMILAR ref. 1606.36362 98419235</p> <p>1606.36363 98419234</p> <p style="text-align: right;">DX RH</p> <p style="text-align: right;">SX LH</p>
 	<p>FANALINO PEDANA LATERALE SIDE LAMP FOOTSTEP</p> <p>COS.PEL. ref. SIMILAR ref. 1606.36364 500368110</p> <p>1606.36365 500368111</p> <p style="text-align: right;">DX RH</p> <p style="text-align: right;">SX LH</p>
 	<p>FANALINO CORNER LAMP</p> <p>COS.PEL. ref. SIMILAR ref. 1606.48480 98449181</p> <p>1606.48481 98449182</p> <p style="text-align: right;">DX RH</p> <p style="text-align: right;">SX LH</p>
 	<p>FANALINO VISIERA NERO - 91 -> SUN VISOR'S MARKER BLACK - 91 -></p> <p>COS.PEL. ref. SIMILAR ref. 1606.75920 500314717</p> <p>1606.75921 500314716</p> <p style="text-align: right;">DX RH</p> <p style="text-align: right;">SX LH</p>
 	<p>FANALINO VISIERA ARGENTO - 91 -> SUN VISOR'S MARKER SILVER - 91 -></p> <p>COS.PEL. ref. SIMILAR ref. 1606.75922 98461649</p> <p>1606.75923 98461648</p> <p style="text-align: right;">DX RH</p> <p style="text-align: right;">SX LH</p>

	<p>PROIETTORE H4 H3 - PREDISPOSTO PER CORRETTORE ASSETTO HEADLAMP H4 H3 - SUITABLE FOR LOAD LEVEL ADJUSTEMENT COS.PEL. ref. SIMILAR ref. 1606.05102 500305102 DX RH</p> <p>1606.05103 500305103 SX LH</p>
	<p>PROIETTORE H3 H4 - CORRETTORE ASSETTO MANUALE HEADLAMP H3 H4 - MANUAL LOAD LEVEL ADJUSTEMENT COS.PEL. ref. SIMILAR ref. 1606.48440 4861793 DX RH</p> <p>1606.48441 4861794 SX LH</p>
	<p>MANIGLIA PORTA NERO - CON CHIAVE DOOR HANDLE BLACK - WITH KEY COS.PEL. ref. SIMILAR ref. 1706.60900 98404709 DX RH</p> <p>1706.60901 98404710 SX LH</p>
	<p>KIT MANIGLIE PORTE NERO - CON CHIAVI DOOR HANDLE KIT BLACK - WITH KEYS COS.PEL. ref. SIMILAR ref. 1706.60902 500335296 / 98404714 DX-SX RH-LH</p>
	<p>SERRATURA PORTA ELETTRICA ELECTRIC DOOR LOCK COS.PEL. ref. SIMILAR ref. 1706.60906 98411951 / 98416419 DX RH</p> <p>1706.60905 98411952 / 98416424 SX LH</p>
	<p>ARRESTO PORTA DOOR STOP COS.PEL. ref. SIMILAR ref. 1706.60908 5802132946 / 99476267 DX RH</p> <p>1706.60907 5802132944 / 99476268 SX LH</p>
	<p>GUARNIZIONE PARABREZZA WINDSCREEN GASKET COS.PEL. ref. SIMILAR ref. 1806.44015 8143853</p>
	<p>GUIDA VETRO WINDOW FRAME COS.PEL. ref. SIMILAR ref. 1806.60134 98484152 DX RH</p> <p>1806.60133 98404902 SX LH</p>







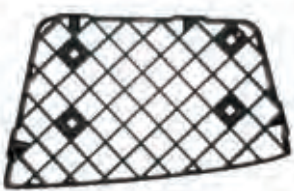

	<p>ALZACRISTALLI ELETTTRICO - CON MOTORINO - 2 PIN WINDOW REGULATOR ELECTRIC - WITH MOTOR - 2 PIN COS.PEL. ref. SIMILAR ref. 1906.60032 2997195 / 98407721 / 99487780</p> <p>1906.60033 2997196 / 98407722 / 99487781</p> <p style="text-align: right;">DX RH</p> <p style="text-align: right;">SX LH</p>
	<p>SERBATOIO LAVACRISTALLI TANK</p> <p>COS.PEL. ref. SIMILAR ref. 2106.43080 98409491</p>
	<p>TIRANTE PARAFANGO POSTERIORE GOMMA - NERO MUDGUARD TENSIONER RUBBER - BLACK</p> <p>COS.PEL. ref. SIMILAR ref. 1001.00001 42533556 / 42559051</p>
	<p>TIRANTE COPRI BATTERIA CORTO 140 mm MUDGUARD TENSIONER SHORT 140 mm</p> <p>COS.PEL. ref. SIMILAR ref. 1006.90107 4605163</p>
	<p>TIRANTE COPRI BATTERIA LUNGO 144 mm MUDGUARD TENSIONER LONG 144 mm</p> <p>COS.PEL. ref. SIMILAR ref. 1006.90109 4784894</p>
	<p>MOLLA A GAS Lunghezza [mm] 710 Corsa [mm] 300 Forza scarto [N] 280 GAS SPRING Lenght [mm] 710 Stroke [mm] 300 Waste force [N] 280</p> <p>COS.PEL. ref. SIMILAR ref. 2406.48100 98483247</p>
	<p>DEFLETTORI LATERALI CON CLIPS SIDEWINDOW DEFLECTORS WITH CLIPS</p> <p>COS.PEL. ref. SIMILAR ref. 3006.00000 -</p>
	<p>FANALE POSTERIORE REAR-LIGHT 7 FUNZIONI - SENZA LUCE TARGA 7 FUNCTIONS - W/O PLATE LIGHT</p> <p>COS.PEL. ref. SIMILAR ref. 006140 -</p> <p>006150 -</p> <p>TRASPARENTE / LENS Relativo connettore 003105 011111 -</p> <p style="text-align: right;">DX RH</p> <p style="text-align: right;">SX LH</p> <p style="text-align: right;">DX-SX RH-LH</p>

	<p>FANALE POSTERIORE REAR-LIGHT 7 FUNZIONI - SENZA L. TARGA - CON BORDO BIANCO 7 FUNCTIONS - W/O PLATE LIGHT - WITH WHITE EDGE</p> <p>COS.PEL. ref. 006142 SIMILAR ref. 99463242 Relativo connettore 003105 006141 99463243 Relativo connettore 003105</p> <p>TRASPARENTE / LENS 011110 93161844</p> <p>DX RH SX LH DX-SX RH-LH</p>
	<p>FANALE POSTERIORE REAR-LIGHT 7 FUNZIONI - CON LUCE TARGA - CON BORDO BIANCO 7 FUNCTIONS - WITH PLATE LIGHT - WITH WHITE EDGE</p> <p>COS.PEL. ref. 006143 SIMILAR ref. 99463244 Con luce targa / With plate light - conn. 003105</p> <p>TRASPARENTE / LENS 011110 93161844</p> <p>SX LH DX-SX RH-LH</p>
	<p>FANALE POSTERIORE REAR-LIGHT LED LED</p> <p>COS.PEL. ref. 006152 SIMILAR ref. - Relativo connettore 003105 006151 - Con luce targa / With plate light - conn. 003105</p> <p>TRASPARENTE / LENS 011112 -</p> <p>DX RH SX LH DX-SX RH-LH</p>
	<p>FANALE POSTERIORE REAR-LIGHT 7 FUNZIONI - CON LUCE TARGA 7 FUNCTIONS - WITH PLATE LIGHT</p> <p>COS.PEL. ref. 006880 SIMILAR ref. - Relativo connettore 003105</p> <p>TRASPARENTE / LENS 011111 -</p> <p>SX LH DX-SX RH-LH</p>

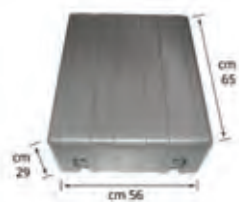

	<p>RIPAROFANGO POSTERIORE P.P.T. - GRIGIO REAR MUDGUARD P.P.T. - GREY COS.PEL. ref. SIMILAR ref. 206.00002 8144469</p> <p>206.00001 8144468</p> <p style="text-align: right;">DX RH</p> <p style="text-align: right;">SX LH</p>
	<p>PEDANA PARAFANGO S.M.C. - GRIGIO MUDGUARD FOOTSTEP S.M.C. - GREY COS.PEL. ref. SIMILAR ref. 206.44000 8144329</p> <p>206.44001 Griglia/Grille : 1006.00008 8144328</p> <p style="text-align: right;">DX RH</p> <p style="text-align: right;">SX LH</p> <p style="text-align: center;">Griglia/Grille : 1006.00008</p>
	<p>PROLUNGA PARAFANGO LATERALE CABINA CORTA - S.M.C. - GRIGIO EXTENSION MUDGUARD SHORT CAB - S.M.C. - GREY COS.PEL. ref. SIMILAR ref. 206.44002 8144315</p> <p>206.44003 8144314</p> <p style="text-align: right;">DX RH</p> <p style="text-align: right;">SX LH</p>
 <p style="text-align: right;">cm 20,5 cm 66,5 cm 67</p>	<p>CALOTTA PARAFANGO POSTERIORE P.P. - GRIGIO REAR MUDGUARD P.P. - GREY COS.PEL. ref. SIMILAR ref. 206.02927 41002927 sx / 41003236 dx</p> <p style="text-align: right;">DX-SX RH-LH</p>
	<p>PEDANA SENZA FANALINO - CON TAPPO - R.I.M. - GREY FOOTSTEP WITHOU LAMP - R.I.M. - GREY COS.PEL. ref. SIMILAR ref. 306.66164 98466328</p> <p>306.66163 98466330</p> <p style="text-align: right;">DX RH</p> <p style="text-align: right;">SX LH</p>

	<p>RIPARO A.B.S. - GRIGIO ENGINE PROTECTION A.B.S. - GREY COS.PEL. ref. SIMILAR ref. 306.79578 3798110</p> <p>306.79579 3798109</p> <p style="text-align: right;">DX RH</p> <p style="text-align: right;">SX LH</p>
	<p>RIPARO A.B.S. - GRIGIO ENGINE PROTECTION A.B.S. - GREY COS.PEL. ref. SIMILAR ref. 306.79586 3797065</p> <p>306.79587 3797064</p> <p style="text-align: right;">DX RH</p> <p style="text-align: right;">SX LH</p>
	<p>PEDANA CON FORO FANALINO - P.P.G.F. - GRIGIO FOOTSTEP WITH LAMP HOLE - P.P.G.F. - GREY COS.PEL. ref. SIMILAR ref. 306.66162 2997120 / 98466161</p> <p>306.66161 2997121 / 98466162</p> <p style="text-align: right;">DX RH</p> <p style="text-align: right;">SX LH</p> <p style="text-align: center;">Griglia/Grille: 1006.00007 Griglia/Grille: 1006.00007</p>
	<p>PEDANA SUPPLEMENTARE ADDITIONAL FOOTSTEP</p> <p>COS.PEL. ref. SIMILAR ref. 306.66170 3798915</p> <p style="text-align: right;">DX-SX RH-LH</p> <p style="text-align: center;">Griglia/Grille : 1006.00006 inf. - 1006.00007 sup.</p>
<p>AD ESAURIMENTO SCORTE UNTIL SELLS-OUT</p> 	<p>PARAURTI CENTRALE METALLO - NERO CENTRAL BUMPER METAL - BLACK</p> <p>COS.PEL. ref. SIMILAR ref. 406.66100 3799217</p>
<p>AD ESAURIMENTO SCORTE UNTIL SELLS-OUT</p> 	<p>ANGOLO PARAURTI METALLO - NERO CORNER BUMPER METAL - BLACK COS.PEL. ref. SIMILAR ref. 406.66102 98480269</p> <p>406.66101 98480268</p> <p style="text-align: right;">DX RH</p> <p style="text-align: right;">SX LH</p>
	<p>PREDELLINO DI SALITA SU PARAURTI ANTERIORE METALLO - NERO PIPE METAL - BLACK COS.PEL. ref. SIMILAR ref. 406.66103 98459188</p>
	<p>SUPPORTO LAMPEGGIANTE FLASHING SUPPORT</p> <p>COS.PEL. ref. SIMILAR ref. 706.66100 98445371</p>

	<p>GRIGLIA PARAURTI ALLUMINIO BUMPER GRILLE ALUMINIUM</p> <p>COS.PEL. ref. SIMILAR ref. 1006.00006 3798587</p>
	<p>GRIGLIA PEDANA CENTRALE ALLUMINIO CENTRE FOOTSTEP GRILLE ALUMINIUM</p> <p>COS.PEL. ref. SIMILAR ref. 1006.00007 3798583</p> <p style="text-align: right;">DX-SX RH-LH</p>
	<p>GRIGLIA PEDANA ALLUMINIO FOOTSTEP GRILLE ALUMINIUM</p> <p>COS.PEL. ref. SIMILAR ref. 1006.00008 3798586 / 8142607</p> <p style="text-align: right;">DX-SX RH-LH</p>
	<p>COPRI BATTERIA P.P. BATTERY COVER P.P.</p> <p>COS.PEL. ref. SIMILAR ref. 1006.90106 98474429</p>
	<p>PORTALAMPADA LAMP BULB HOLDER</p> <p>COS.PEL. ref. SIMILAR ref. 002987 -</p> <p style="text-align: right;">Per lampada / For lamp : 002988</p>
  	<p>FANALINO LATERALE W5W SIDE LAMP W5W</p> <p>COS.PEL. ref. SIMILAR ref. 002988 41200664</p> <p style="text-align: right;">DX-SX RH-LH</p> <p style="text-align: right;">Relativo portalampada 002987</p>
	<p>SERRATURA PORTA ELETTRICA ELECTRIC DOOR LOCK</p> <p>COS.PEL. ref. SIMILAR ref. 1706.60906 98411951 / 98416419</p> <p style="text-align: right;">DX RH</p> <p>1706.60905 98411952 / 98416424</p> <p style="text-align: right;">SX LH</p>
	<p>ARRESTO PORTA DOOR STOP</p> <p>COS.PEL. ref. SIMILAR ref. 1706.60908 5802132946 / 99476267</p> <p style="text-align: right;">DX RH</p> <p>1706.60907 5802132944 / 99476268</p> <p style="text-align: right;">SX LH</p>

	<p>GUIDA VETRO WINDOW FRAME</p> <p>COS.PEL. ref. SIMILAR ref. 1806.60134 98484152</p> <p>1806.60133 98404902</p> <p style="text-align: right;">DX RH</p> <p style="text-align: right;">SX LH</p>
	<p>VASCHETTA ESPANSIONE EXPANSION TANK</p> <p>COS.PEL. ref. SIMILAR ref. 2106.43081 8166285</p>
	<p>TIRANTE COPRI BATTERIA CORTO 140 mm MUDGUARD TENSIONER SHORT 140 mm</p> <p>COS.PEL. ref. SIMILAR ref. 1006.90107 4605163</p>
	<p>TIRANTE COPRI BATTERIA LUNGO 144 mm MUDGUARD TENSIONER LONG 144 mm</p> <p>COS.PEL. ref. SIMILAR ref. 1006.90109 4784894</p>

Stralis Trakker





COS.IVE

	<p>GRIGLIA S.M.C. GRILLE S.M.C.</p> <p>COS.PEL. ref. 106.70436 SIMILAR ref. 504056436</p> <p>Relativa cerniera 1006.70604</p>
	<p>RIPAROFANGO POSTERIORE P.P.T. - GRIGIO FOOTSTEP MUDGUARD P.P.T. - GREY</p> <p>COS.PEL. ref. 206.54008 SIMILAR ref. 504003993 / 504208707 DX RH</p> <p>206.54009 504003992 / 504208706 SX LH</p>
	<p>PEDANA PARAFANGO S/ALETTA S.M.C. - GRIGIO MUDGUARD FOOTSTEP S.M.C. - GREY</p> <p>COS.PEL. ref. 206.70530 SIMILAR ref. 504103239 / 504211275 DX RH</p> <p>206.70531 504103238 / 504211274 SX LH</p>
	<p>PEDANA P.P.G.F. - NERO FOOTSTEP P.P.G.F. - BLACK</p> <p>COS.PEL. ref. 306.78190 SIMILAR ref. 2997737 / 504161152 DX RH</p> <p>306.78191 2997736 / 504161151 SX LH</p>
	<p>PEDANA P.P.G.F. - NERO FOOTSTEP P.P.G.F. - BLACK</p> <p>COS.PEL. ref. 306.78192 SIMILAR ref. 2997735 / 504161150 DX RH</p> <p>306.78193 2997734 / 504161149 SX LH</p>

	<p>PEDANA P.P.G.F. - NERO FOOTSTEP P.P.G.F. - BLACK COS.PEL. ref. 306.78194</p> <p>SIMILAR ref. 2997733 / 504103237</p> <p>DX RH</p> <p>306.78195 2997732 / 504103236 SX LH</p>
	<p>PEDANA P.P.G.F. - NERO FOOTSTEP P.P.G.F. - BLACK COS.PEL. ref. 306.78196</p> <p>SIMILAR ref. 2997731 / 504103235</p> <p>DX RH</p> <p>306.78197 2997730 / 504103234 SX LH</p>
	<p>PEDANA P.P.G.F. FOOTSTEP P.P.G.F.</p> <p>COS.PEL. ref. 306.78201</p> <p>SIMILAR ref. 504097984</p> <p>DX-SX RH-LH</p>
	<p>KIT PEDANA FOOTSTEP KIT</p> <p>COS.PEL. ref. 306.78202</p> <p>SIMILAR ref. 504097984 / 504097996 / 504102899 / 504102900 306.78200 + 306.78201 + 1006.78996 (x 2)</p>
	<p>PEDANA P.P.G.F. - GRIGIO FOOTSTEP P.P.G.F. - GREY COS.PEL. ref. 306.78198</p> <p>SIMILAR ref. 2997524 / 504103233 / 504218912</p> <p>DX RH</p> <p>306.78199 2997523 / 504103232 / 504218911 SX LH</p>
	<p>PEDANA P.C. H.D. - GRIGIO FOOTSTEP P.C. H.D. - GREY</p> <p>COS.PEL. ref. 306.78200</p> <p>SIMILAR ref. 504102899</p> <p>DX-SX RH-LH</p>
	<p>PARAURTI CENTRALE METALLO FRONT CENTRE BUMPER STEEL</p> <p>COS.PEL. ref. 406.78090</p> <p>SIMILAR ref. 504060073</p>
	<p>ANGOLO PARAURTI METALLO CORNER BUMPER STEEL</p> <p>COS.PEL. ref. 406.78092</p> <p>SIMILAR ref. 504091075</p> <p>DX RH</p> <p>406.78091 504091076 SX LH</p>

Stralis Trakker

	<p>CONVOGLIATORE ARIA P.P. AIR CONVEYOR P.P.</p> <p>COS.PEL. ref. SIMILAR ref. 906.70180 504056033</p> <p>906.70181 504056034 / 504203478</p> <p style="text-align: right;">DX RH</p> <p style="text-align: right;">SX LH</p>
	<p>STAFFA PORTAFARO POSTERIORE METALLO REAR-LIGHT BRACKET METAL</p> <p>COS.PEL. ref. SIMILAR ref. 1006.78994 41027657</p> <p>1006.78995 41027658</p> <p style="text-align: right;">DX RH</p> <p style="text-align: right;">SX LH</p>
	<p>STAFFA PEDANA METALLO FOOTSTEP BRACKET METAL</p> <p>COS.PEL. ref. SIMILAR ref. 1006.78996 504097996</p>
	<p>STAFFA PEDANA METALLO FOOTSTEP BRACKET METAL</p> <p>COS.PEL. ref. SIMILAR ref. 1006.78997 504097971</p>
	<p>COPRI BATTERIA P.P. BATTERY COVER P.P.</p> <p>COS.PEL. ref. SIMILAR ref. 1006.90106 98474429</p>
	<p>PORTALAMPADA LAMP BULB HOLDER</p> <p>COS.PEL. ref. SIMILAR ref. 002987 -</p> <p style="text-align: right;">Per lampada / For lamp : 002988</p>
 	<p>FANALINO LATERALE W5W SIDE LAMP W5W</p> <p>COS.PEL. ref. SIMILAR ref. 002988 41200664</p> <p style="text-align: right;">DX-SX RH-LH</p> <p style="text-align: right;">Relativo portalampada 002987</p>
	<p>SERRATURA PORTA ELETTRICA ELECTRIC DOOR LOCK</p> <p>COS.PEL. ref. SIMILAR ref. 1706.60906 98411951 / 98416419</p> <p>1706.60905 98411952 / 98416424</p> <p style="text-align: right;">DX RH</p> <p style="text-align: right;">SX LH</p>

	<p>ARRESTO PORTA DOOR STOP</p> <p>COS.PEL. ref. SIMILAR ref. 1706.60908 5802132946 / 99476267 DX RH</p> <p>1706.60907 5802132944 / 99476268 SX LH</p>
	<p>GUIDA VETRO WINDOW FRAME</p> <p>COS.PEL. ref. SIMILAR ref. 1806.60134 98484152 DX RH</p> <p>1806.60133 98404902 SX LH</p>
	<p>ALZACRISTALLI ELETTRICO - CON MOTORINO - 2 PIN WINDOW REGULATOR ELECTRIC - WITH MOTOR - 2 PIN</p> <p>COS.PEL. ref. SIMILAR ref. 1906.60032 2997195 / 98407721 / 99487780 DX RH</p> <p>1906.60033 2997196 / 98407722 / 99487781 SX LH</p>
	<p>ALZACRISTALLI ELETTRICO - CON MOTORINO - 2 PIN WINDOW REGULATOR ELECTRIC - WITH MOTOR - 2 PIN</p> <p>COS.PEL. ref. SIMILAR ref. 1906.90030 504040988 / 504157968 / 5801324907 DX RH</p> <p>1906.90031 504040989 / 504157969 / 5801324893 SX LH</p>
	<p>TIRANTE COPRI BATTERIA CORTO 140 mm MUDGUARD TENSIONER SHORT 140 mm</p> <p>COS.PEL. ref. SIMILAR ref. 1006.90107 4605163</p>
	<p>TIRANTE COPRI BATTERIA LUNGO 144 mm MUDGUARD TENSIONER LONG 144 mm</p> <p>COS.PEL. ref. SIMILAR ref. 1006.90109 4784894</p>

Stralis AD/AT











	<p>GRIGLIA S.M.C. GRILLE S.M.C.</p> <p>COS.PEL. ref. SIMILAR ref. 106.70436 504056436</p> <p>Relativa cerniera 1006.70604</p>
	<p>RIPAROFANGO POSTERIORE P.P.T. - GRIGIO FOOTSTEP MUDGUARD P.P.T. - GREY</p> <p>COS.PEL. ref. SIMILAR ref. 206.54008 504003993 / 504208707 DX RH</p> <p>206.54009 504003992 / 504208706 SX LH</p>
	<p>PEDANA PARAFANGO S/ALETTA S.M.C. - GRIGIO MUDGUARD FOOTSTEP S.M.C. - GREY</p> <p>COS.PEL. ref. SIMILAR ref. 206.70530 504103239 / 504211275 DX RH</p> <p>206.70531 504103238 / 504211274 SX LH</p>
	<p>COPERCHIO PARAFANGO POSTERIORE P.P. - GRIGIO - CON STAFFA COVER REAR MUDGUARD P.P. - GREY - WITH BRACKET</p> <p>COS.PEL. ref. SIMILAR ref. 206.80700 41218984 DX RH</p> <p>206.80701 41218983 SX LH</p>
	<p>COPERCHIO PARAFANGO POSTERIORE PARTE ANT. P.P. - GRIGIO COVER REAR MUDGUARD FRONT SIDE P.P. - GREY</p> <p>COS.PEL. ref. SIMILAR ref. 206.80702 41213720 DX RH</p> <p>206.80703 41213721 SX LH</p>











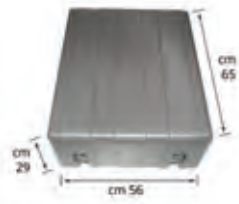

	<p>RIPARO ANTISPRAY Per 206.80751 MUDGUARD INNER For 206.80751</p> <p>COS.PEL. ref. SIMILAR ref. 206.80754 41299384</p> <p style="text-align: right;">DX-SX RH-LH</p>
	<p>CALOTTA PARAF. POST. BASSA CON 4 TIRANTI P.P. - GRIGIO REAR MUDGUARD LOW WITH 4 M. TENSIONERS P.P. - GREY</p> <p>COS.PEL. ref. SIMILAR ref. 206.80747 2997670 / 41213696 / 41213751 (206.80749 versione senza i tiranti)</p> <p style="text-align: right;">DX-SX RH-LH</p>
	<p>CALOTTA PARAF. POST. CON 4 TIRANTI P.P. - GRIGIO REAR MUDGUARD WITH 4 MUDGUARD TENSIONERS P.P. - GREY</p> <p>COS.PEL. ref. SIMILAR ref. 206.80748 2997670 / 41213750 (206.80750 versione senza i tiranti)</p> <p style="text-align: right;">DX-SX RH-LH</p>
	<p>CALOTTA PARAFANGO POSTERIORE BASSA P.P. - GRIGIO REAR MUDGUARD P.P. - GREY</p> <p>COS.PEL. ref. SIMILAR ref. 206.80749 41213751</p> <p style="text-align: right;">DX-SX RH-LH</p> <p>Relativo tirante 1006.80696 - (206.80747 versione con i tiranti)</p>
	<p>CALOTTA PARAFANGO POSTERIORE P.P. - GRIGIO REAR MUDGUARD P.P. - GREY</p> <p>COS.PEL. ref. SIMILAR ref. 206.80750 41213750</p> <p style="text-align: right;">DX-SX RH-LH</p> <p>Relativo tirante 1006.80696 - (206.80748 versione con i tiranti)</p>
	<p>MEZZO PARAFANGO POSTERIORE PARTE POSTERIORE (STAFFA INTERNA LUNGA) - P.P. - GRIGIO REAR MUDGUARD REAR SIDE (LONG INTERNAL BRACKET) - P.P. - GREY</p> <p>COS.PEL. ref. SIMILAR ref. 206.80751 41213754</p> <p style="text-align: right;">DX-SX RH-LH</p> <p>Staffa interna lunga - Relativo antispray 206.80754</p>
	<p>MEZZO PARAFANGO POSTERIORE PARTE ANTERIORE (STAFFA INTERNA CORTA) - P.P. - GRIGIO REAR MUDGUARD FRONT SIDE (SHORT INTERNAL BRACKET) - P.P. - GREY</p> <p>COS.PEL. ref. SIMILAR ref. 206.80752 41213753</p> <p style="text-align: right;">DX-SX RH-LH</p> <p>Staffa interna corta</p>
	<p>MEZZO PARAFANGO POSTERIORE SENZA STAFFE SENZA STAFFE - P.P. - GRIGIO REAR MUDGUARD W/O BRACKETS WITHOUT BRACKETS - P.P. - GREY</p> <p>COS.PEL. ref. SIMILAR ref. 206.80753 -</p> <p style="text-align: right;">DX-SX RH-LH</p> <p>Senza staffe - Relativo antispray 206.80754</p>

Stralis AD/AT

	<p>PEDANA SUPERIORE P.P.G.F. - NERO UPPER FOOTSTEP P.P.G.F. - BLACK COS.PEL. ref. SIMILAR ref. 306.80018 504001361 / 504217554 nero DX RH</p> <p>306.80019 504001358 / 504217553 nero SX LH</p>
	<p>PEDANA INFERIORE P.P.G.F. - NERO LOWER FOOTSTEP P.P.G.F. - BLACK COS.PEL. ref. SIMILAR ref. 306.80020 504001345 / 504217526 nero DX RH</p> <p>306.80021 504001344 / 504217525 nero SX LH</p>
	<p>RIPARO PEDANA P.P. - GRIGIO FOOTSTEP PROTECTION P.P. - GREY COS.PEL. ref. SIMILAR ref. 306.80600 504033938 DX RH</p> <p>306.80601 504033939 SX LH</p>
	<p>PEDANA PER PARAURTI IN FERRO SENZA FORI P.P.G.F. - GRIGIO - PER PARAURTI IN FERRO FOOTSTEP FOR BUMPER P.P.G.F. - GREY - FOR IRON BUMPER COS.PEL. ref. SIMILAR ref. 306.80014 2997579 / 504215973 grigio / 504368370 DX RH nero</p> <p>306.80015 2997578 / 504215971 grigio / 504368371 SX LH nero</p>
	<p>PEDANA P.P.G.F. - GRIGIO FOOTSTEP P.P.G.F. - GREY COS.PEL. ref. SIMILAR ref. 306.80016 2997119 / 500375431 DX RH</p> <p>306.80017 2997118 / 500375430 SX LH</p>
	<p>PEDANA P.P.G.F. - BIANCO BRILLANTE FOOTSTEP P.P.G.F. - WHITE COS.PEL. ref. SIMILAR ref. 306.80024 2997119 / 500375431 DX RH</p> <p>306.80025 306.80028 : ROSSO MARANELLO SX LH 2997118 / 500375430 306.80029 : ROSSO MARANELLO</p>
	<p>GRIGLIA PARAURTI SUPERIORE BUMPER GRILLE COS.PEL. ref. SIMILAR ref. 406.83942 500380102</p>
	<p>GRIGLIA PARAURTI INFERIORE UPPER BUMPER GRILLE COS.PEL. ref. SIMILAR ref. 406.83943 500380104</p>

	<p>COPERCHIO LATERALE SIDE COVER</p> <p>COS.PEL. ref. SIMILAR ref. 406.83944 500380095 / 504042188 DX RH</p> <p>406.83945 500380094 / 504042187 SX LH</p>
	<p>PARAURTI ANTERIORE S.M.C. - GRIGIO FRONT BUMPER S.M.C. - GREY</p> <p>COS.PEL. ref. SIMILAR ref. 406.83947 500383947 / 504103112</p>
	<p>PARAURTI ANTERIORE SENZA FORI FENDI S.M.C. - GRIGIO FRONT BUMPER W/O HOLES S.M.C. - GREY</p> <p>COS.PEL. ref. SIMILAR ref. 406.83949 504103111</p>
	<p>SOTTOPARAURTI 2a serie P.P.T. - GRIGIO SPOILER 2nd series P.P.T. - GREY</p> <p>COS.PEL. ref. SIMILAR ref. 406.74676 504065982 DX RH</p> <p>406.74677 504074676 SX LH</p>
	<p>ANGOLO PARAURTI 2a serie P.P. - GRIGIO CORNER SPOILER 2nd series P.P. - GREY</p> <p>COS.PEL. ref. SIMILAR ref. 406.80100 504065985 DX RH</p> <p>406.80101 504065984 SX LH</p>
	<p>PEDANA PARAURTI P.P. - NERO UPPER BUMPER FOOTSTEP P.P. - BLACK</p> <p>COS.PEL. ref. SIMILAR ref. 406.90102 500380111 / 504032325 / 504194669</p>
	<p>VISIERA STRALIS AD-AT 1a serie SENZA STAFFE SUN VISOR STRALIS AD-AT 1st series W/O BRACKETS</p> <p>COS.PEL. ref. SIMILAR ref. 706.70600 504056838 / 504089372</p> <p>Relativo kit staffe 1006.70600</p>
	<p>CONVOGLIATORE ARIA P.P. AIR CONVEYOR P.P.</p> <p>COS.PEL. ref. SIMILAR ref. 906.70180 504056033 DX RH</p> <p>906.70181 504056034 / 504203478 SX LH</p>

Stralis AD/AT

	<p>GRIGLIA PEDANA PLASTICA FOOTSTEP GRILLE PLASTIC</p> <p>COS.PEL. ref. SIMILAR ref. 1006.70532 504242345</p> <p>1006.70533 Relativa pedana: 206.70530 / 206.70532 / 206.93202 / 206.93204 504242346 SX LH</p> <p>Relativa pedana: 206.70531 / 206.70533 / 206.93203 / 206.93205</p>
	<p>CERNIERA CALANDRA ANTERIORE P.P.G.F. BRACKET P.P.G.F.</p> <p>COS.PEL. ref. SIMILAR ref. 1006.70604 500368694 / 504306106</p>
	<p>COPRI BATTERIA P.P. BATTERY COVER P.P.</p> <p>COS.PEL. ref. SIMILAR ref. 1006.90106 98474429</p>
	<p>BOTTONE PEDANA PARAURTI FRONT BUMPER CLIP</p> <p>COS.PEL. ref. SIMILAR ref. 1006.90110 504194581</p>
	<p>PORTALAMPADA LAMP BULB HOLDER</p> <p>COS.PEL. ref. SIMILAR ref. 002987 -</p> <p>Per lampada / For lamp : 002988</p>
  	<p>FANALINO LATERALE W5W SIDE LAMP W5W</p> <p>COS.PEL. ref. SIMILAR ref. 002988 41200664</p> <p>DX-SX RH-LH</p> <p>Relativo portalampada 002987</p>
  	<p>FANALE LATERALE LAMPADINA ATTACCO AMP - JPT - Relativo connettore 003122 SIDE LAMP BULB CONNECTION AMP - JPT - Related connector 003122</p> <p>COS.PEL. ref. SIMILAR ref. 003001 500308514</p> <p>DX-SX RH-LH</p> <p>ARANCIO / ORANGE - Relativo portalampada 1601.50013</p>
	<p>PORTALAMPADA Relativo connettore 003122 (JPT) LAMP BULB HOLDER Related connector 003122 (JPT)</p> <p>COS.PEL. ref. SIMILAR ref. 1601.50013 -</p> <p>Per lampada / For lamp : 003001 / 003003 / 003004</p>

 	<p>FANALINO INGOMBRO CABINA DRIVER'S CAB SIDE MARKER</p> <p>COS.PEL. ref. SIMILAR ref. 1606.75604 504055623 DX RH</p> <p>1606.75603 504045133 SX LH</p>
 	<p>FANALINO CORNER LAMP</p> <p>COS.PEL. ref. SIMILAR ref. 1606.80040 41221040 / 42555022 DX RH</p> <p>1606.80041 41221041 / 42555023 SX LH</p>
 	<p>FANALINO LATERALE 2 FORI - GRIGIO CORNER LAMP 2 HOLES - GREY</p> <p>COS.PEL. ref. SIMILAR ref. 1606.80044 504098243 grigio / 504250999 DX RH nero</p> <p>1606.80045 504098245 grigio / 504250991 SX LH nero</p>
 	<p>FANALINO VISIERA 03 -> SUN VISOR' MARKER 03 -></p> <p>COS.PEL. ref. SIMILAR ref. 1606.80046 504047265 DX RH</p> <p>1606.80047 504047264 SX LH</p>
 	<p>FANALINO LATERALE 3 FORI - GRIGIO SIDE LAMP 3 HOLES - GREY</p> <p>COS.PEL. ref. SIMILAR ref. 1606.90602 41221039 GRIGIO / 504250984 DX RH NERO Relativo portalampada 1606.92811 - 003123</p> <p>1606.90603 41221029 GRIGIO / 504250958 SX LH NERO Relativo portalampada 1606.92811 - 003123</p>
	<p>PORTALAMPADA LAMP BULB HOLDER</p> <p>COS.PEL. ref. SIMILAR ref. 1606.92811 -</p> <p>Per lampada / For lamp : 1606.90602/3</p>
 	<p>PROIETTORE H7 H7 - CORRETTORE ASSETTO MANUALE / ELETTRICO SENZA MOTORINO HEADLAMP H7 H7 - MANUAL LOAD LEVEL ADJUSTEMENT / ELECTRIC W/O MOTOR</p> <p>COS.PEL. ref. SIMILAR ref. 1606.80038 504020189 DX RH</p> <p>1606.80039 504020193 SX LH</p>
 	<p>FENDINEBBIA ESTERNO H1 -> 07 OUTSIDE FOG LAMP H1 -> 07</p> <p>COS.PEL. ref. SIMILAR ref. 1606.80042 504032145 DX-SX RH-LH</p>

Stralis AD/AT

 	<p>FENDINEBBIA INTERNO H1 -> 07 INSIDE FOG LAMP H1 -> 07</p> <p>COS.PEL. ref. SIMILAR ref. 1606.80043 504032148</p> <p style="text-align: right;">DX-SX RH-LH</p>
	<p>SERRATURA PORTA ELETTRICA ELECTRIC DOOR LOCK</p> <p>COS.PEL. ref. SIMILAR ref. 1706.60906 98411951 / 98416419</p> <p style="text-align: right;">DX RH</p> <p>1706.60905 98411952 / 98416424</p> <p style="text-align: right;">SX LH</p>
	<p>ARRESTO PORTA DOOR STOP</p> <p>COS.PEL. ref. SIMILAR ref. 1706.60908 5802132946 / 99476267</p> <p style="text-align: right;">DX RH</p> <p>1706.60907 5802132944 / 99476268</p> <p style="text-align: right;">SX LH</p>
	<p>MANIGLIA PORTA NERO - CON CHIAVE DOOR HANDLE BLACK - WITH KEY</p> <p>COS.PEL. ref. SIMILAR ref. 1706.80800 -</p> <p style="text-align: right;">DX RH</p> <p>1706.80801 -</p> <p style="text-align: right;">SX LH</p>
	<p>KIT MANIGLIE PORTE CON CHIAVE NERO - CON CHIAVE KIT DOOR HANDLE WITH KEY BLACK - WITH KEY</p> <p>COS.PEL. ref. SIMILAR ref. 1706.80802 504052936</p> <p style="text-align: right;">DX-SX RH-LH</p>
	<p>GUARNIZIONE PARABREZZA WINDSCREEN GASKET</p> <p>COS.PEL. ref. SIMILAR ref. 1806.24015 8143852</p>
	<p>GUIDA VETRO WINDOW FRAME</p> <p>COS.PEL. ref. SIMILAR ref. 1806.60134 98484152</p> <p style="text-align: right;">DX RH</p> <p>1806.60133 98404902</p> <p style="text-align: right;">SX LH</p>
	<p>ALZACRISTALLI ELETTRICO - CON MOTORINO - 2 PIN WINDOW REGULATOR ELECTRIC - WITH MOTOR - 2 PIN</p> <p>COS.PEL. ref. SIMILAR ref. 1906.60032 2997195 / 98407721 / 99487780</p> <p style="text-align: right;">DX RH</p> <p>1906.60033 2997196 / 98407722 / 99487781</p> <p style="text-align: right;">SX LH</p>

	<p>ALZACRISTALLI ELETTRICO - CON MOTORINO - 2 PIN WINDOW REGULATOR ELECTRIC - WITH MOTOR - 2 PIN COS.PEL. ref. SIMILAR ref. 1906.90030 504040988 / 504157968 / 5801324907 DX RH</p> <p>1906.90031 504040989 / 504157969 / 5801324893 SX LH</p>
<p>AD ESAURIMENTO SCORTE UNTIL SELL-OUT</p> 	<p>VASCHETTA ESPANSIONE EXPANSION TANK</p> <p>COS.PEL. ref. SIMILAR ref. 2106.80080 41215631</p>
	<p>TIRANTE PARAFANGO GOMMA - NERO MUDGUARD TENSIONER RUBBER - BLACK</p> <p>COS.PEL. ref. SIMILAR ref. 1006.80696 2997670 / 41213696</p>
	<p>TIRANTE COPRI BATTERIA CORTO 140 mm MUDGUARD TENSIONER SHORT 140 mm</p> <p>COS.PEL. ref. SIMILAR ref. 1006.90107 4605163</p>
	<p>TIRANTE COPRI BATTERIA LUNGO 144 mm MUDGUARD TENSIONER LONG 144 mm</p> <p>COS.PEL. ref. SIMILAR ref. 1006.90109 4784894</p>
	<p>MOLLA A GAS Lunghezza [mm] 685 Corsa [mm] 295 Forza scarto [N] 260 GAS SPRING Lenght [mm] 685 Stroke [mm] 295 Waste force [N] 260</p> <p>COS.PEL. ref. SIMILAR ref. 2406.83100 500390551</p>
	<p>KIT PER CONNESSIONI ELETTRICHE Connettore 2 vie JPT KIT FOR ELECTRICAL JOINTS Connector 2 ways JPT</p> <p>COS.PEL. ref. SIMILAR ref. 003122 -</p> <p>Connettore per 003001 - 003003 - 003004</p>
	<p>KIT PER CONNESSIONI ELETTRICHE Connettore SUPERSEAL 2 vie femmina KIT FOR ELECTRICAL JOINTS Connector SUPERSEAL ways female</p> <p>COS.PEL. ref. SIMILAR ref. 003123 -</p> <p>Connettore per la serie 1500.xxxxx</p>

Stralis AD/AT



FANALE POSTERIORE REAR-LIGHT

LED - 24V - CONNETTORE POSTERIORE AMP 1.5
LED - 24V - REAR CONNECTOR AMP 1.5

COS.PEL. ref.

SIMILAR ref.

1500.00000

-

Relativo connettore multipolare 003120

1500.00001

-

Relativo connettore multipolare 003120

TRASPARENTE / LENS

DX RH

SX LH



	<p>GRIGLIA S.M.C. GRILLE S.M.C.</p> <p>COS.PEL. ref. SIMILAR ref. 106.80106 500398112</p> <p>Relativa cerniera 1006.70604</p>
	<p>RIPAROFANGO POSTERIORE P.P.T. - GRIGIO FOOTSTEP MUDGUARD P.P.T. - GREY</p> <p>COS.PEL. ref. SIMILAR ref. 206.54008 504003993 / 504208707 DX RH</p> <p>206.54009 504003992 / 504208706 SX LH</p>
	<p>PEDANA PARAFANGO S/FORO S.M.C. - GRIGIO MUDGUARD FOOTSTEP W/O HOLE S.M.C. - GREY</p> <p>COS.PEL. ref. SIMILAR ref. 206.80540 504103307 / 5801840462 DX RH</p> <p>206.80541 504104892 / 504108987 / 5801840490 SX LH</p>
	<p>COPERCHIO PARAFANGO POSTERIORE P.P. - GRIGIO - CON STAFFA COVER REAR MUDGUARD P.P. - GREY - WITH BRACKET</p> <p>COS.PEL. ref. SIMILAR ref. 206.80700 41218984 DX RH</p> <p>206.80701 41218983 SX LH</p>
	<p>COPERCHIO PARAFANGO POSTERIORE PARTE ANT. P.P. - GRIGIO COVER REAR MUDGUARD FRONT SIDE P.P. - GREY</p> <p>COS.PEL. ref. SIMILAR ref. 206.80702 41213720 DX RH</p> <p>206.80703 41213721 SX LH</p>

Stralis AS

	<p>RIPARO ANTISPRAY Per 206.80751 MUDGUARD INNER For 206.80751</p> <p>COS.PEL. ref. 206.80754 SIMILAR ref. 41299384</p> <p style="text-align: right;">DX-SX RH-LH</p>
	<p>CALOTTA PARAF. POST. BASSA CON 4 TIRANTI P.P. - GRIGIO REAR MUDGUARD LOW WITH 4 M. TENSIONERS P.P. - GREY</p> <p>COS.PEL. ref. 206.80747 SIMILAR ref. 2997670 / 41213696 / 41213751 (206.80749 versione senza i tiranti)</p> <p style="text-align: right;">DX-SX RH-LH</p>
	<p>CALOTTA PARAF.POST. CON 4 TIRANTI P.P. - GRIGIO REAR MUDGUARD WITH 4 MUDGUARD TENSIONERS P.P. - GREY</p> <p>COS.PEL. ref. 206.80748 SIMILAR ref. 2997670 / 41213750 (206.80750 versione senza i tiranti)</p> <p style="text-align: right;">DX-SX RH-LH</p>
	<p>CALOTTA PARAFANGO POSTERIORE BASSA P.P. - GRIGIO REAR MUDGUARD P.P. - GREY</p> <p>COS.PEL. ref. 206.80749 SIMILAR ref. 41213751</p> <p style="text-align: right;">DX-SX RH-LH</p> <p>Relativo tirante 1006.80696 - (206.80747 versione con i tiranti)</p>
	<p>CALOTTA PARAFANGO POSTERIORE P.P. - GRIGIO REAR MUDGUARD P.P. - GREY</p> <p>COS.PEL. ref. 206.80750 SIMILAR ref. 41213750</p> <p style="text-align: right;">DX-SX RH-LH</p> <p>Relativo tirante 1006.80696 - (206.80748 versione con i tiranti)</p>
	<p>MEZZO PARAFANGO POSTERIORE PARTE POSTERIORE (STAFFA INTERNA LUNGA) - P.P. - GRIGIO REAR MUDGUARD REAR SIDE (LONG INTERNAL BRACKET) - P.P. - GREY</p> <p>COS.PEL. ref. 206.80751 SIMILAR ref. 41213754</p> <p style="text-align: right;">DX-SX RH-LH</p> <p>Staffa interna lunga - Relativo antispray 206.80754</p>
	<p>MEZZO PARAFANGO POSTERIORE PARTE ANTERIORE (STAFFA INTERNA CORTA) - P.P. - GRIGIO REAR MUDGUARD FRONT SIDE (SHORT INTERNAL BRACKET) - P.P. - GREY</p> <p>COS.PEL. ref. 206.80752 SIMILAR ref. 41213753</p> <p style="text-align: right;">DX-SX RH-LH</p> <p>Staffa interna corta</p>
	<p>MEZZO PARAFANGO POSTERIORE SENZA STAFFE SENZA STAFFE - P.P. - GRIGIO REAR MUDGUARD W/O BRACKETS WITHOUT BRACKETS - P.P. - GREY</p> <p>COS.PEL. ref. 206.80753 SIMILAR ref. -</p> <p style="text-align: right;">DX-SX RH-LH</p> <p>Senza staffe - Relativo antispray 206.80754</p>

	<p>PEDANA SUPERIORE P.P.G.F. - NERO UPPER FOOTSTEP P.P.G.F. - BLACK COS.PEL. ref. SIMILAR ref. 306.80018 504001361 / 504217554 nero DX RH</p> <p>306.80019 504001358 / 504217553 nero SX LH</p>
	<p>PEDANA INFERIORE P.P.G.F. - NERO LOWER FOOTSTEP P.P.G.F. - BLACK COS.PEL. ref. SIMILAR ref. 306.80020 504001345 / 504217526 nero DX RH</p> <p>306.80021 504001344 / 504217525 nero SX LH</p>
	<p>RIPARO PEDANA P.P. - GRIGIO FOOTSTEP PROTECTION P.P. - GREY COS.PEL. ref. SIMILAR ref. 306.80600 504033938 DX RH</p> <p>306.80601 504033939 SX LH</p>
	<p>RIPARO P.P. PROTECTION P.P. COS.PEL. ref. SIMILAR ref. 306.80602 504016519 DX RH</p> <p>306.80603 504016485 SX LH</p>
	<p>RIPARO P.P. PROTECTION P.P. COS.PEL. ref. SIMILAR ref. 306.80604 504017160 DX RH</p> <p>306.80605 504017159 SX LH</p>
	<p>RIPARO P.P. PROTECTION P.P. COS.PEL. ref. SIMILAR ref. 306.80606 504016124 DX RH</p> <p>306.80607 504016123 SX LH</p>
	<p>PEDANA P.P.G.F. - GRIGIO FOOTSTEP P.P.G.F. - GREY COS.PEL. ref. SIMILAR ref. 306.80016 2997119 / 500375431 DX RH</p> <p>306.80017 2997118 / 500375430 SX LH</p>
	<p>PEDANA P.P.G.F. - BIANCO BRILLANTE FOOTSTEP P.P.G.F. - WHITE COS.PEL. ref. SIMILAR ref. 306.80024 2997119 / 500375431 DX RH</p> <p>306.80025 306.80028 : ROSSO MARANELLO 2997118 / 500375430 SX LH</p> <p>306.80029 : ROSSO MARANELLO</p>

ALL ITEMS MENTIONED IN OUR CATALOGUE ARE NOT ORIGINAL PARTS BUT PERFECTLY INTERCHANGEABLE WITH THEM.

GOVERNING LEGISLATIONS FOR THE SALE OF OUR PRODUCTS DIFFER IN EACH COUNTRY.

INFRINGEMENTS, IF ANY, OF LOCAL LEGISLATIONS ARE RESPONSIBILITY OF THE RETAILER IN THE COUNTRY OF FINAL DISTRIBUTION.



Stralis AS

	<p>GRIGLIA PARAURTI SUPERIORE BUMPER GRILLE</p> <p>COS.PEL. ref. SIMILAR ref. 406.83942 500380102</p>
	<p>GRIGLIA PARAURTI INFERIORE UPPER BUMPER GRILLE</p> <p>COS.PEL. ref. SIMILAR ref. 406.83943 500380104</p>
	<p>COPERCHIO LATERALE SIDE COVER</p> <p>COS.PEL. ref. SIMILAR ref. 406.83944 500380095 / 504042188 DX RH</p> <p>406.83945 500380094 / 504042187 SX LH</p>
	<p>PARAURTI ANTERIORE C/FORI FENDINEBBIA S.M.C. - GRIGIO FRONT BUMPER S.M.C. - GREY</p> <p>COS.PEL. ref. SIMILAR ref. 406.83946 500383946 / 504103125</p>
	<p>PARAURTI ANTERIORE SENZA FORI FENDI S.M.C. - GRIGIO FRONT BUMPER W/O HOLES S.M.C. - GREY</p> <p>COS.PEL. ref. SIMILAR ref. 406.83948 504103124</p>
	<p>SOTTOPARAURTI 2a serie P.P.T. - GRIGIO SPOILER 2nd series P.P.T. - GREY</p> <p>COS.PEL. ref. SIMILAR ref. 406.74676 504065982 DX RH</p> <p>406.74677 504074676 SX LH</p>
	<p>ANGOLO PARAURTI 2a serie P.P. - GRIGIO CORNER SPOILER 2nd series P.P. - GREY</p> <p>COS.PEL. ref. SIMILAR ref. 406.80100 504065985 DX RH</p> <p>406.80101 504065984 SX LH</p>
	<p>PEDANA PARAURTI P.P. - NERO UPPER BUMPER FOOTSTEP P.P. - BLACK</p> <p>COS.PEL. ref. SIMILAR ref. 406.90102 500380111 / 504032325 / 504194669</p>

	<p>VISIERA STRALIS AS 1a serie SUN VISOR STRALIS AS 1st series</p> <p>COS.PEL. ref. 706.80700 SIMILAR ref. 504042824</p> <p>Relativo kit staffe 1006.70600</p>
<p>AD ESAURIMENTO SCORTE <small>UNTIL SELL-OUT</small></p> 	<p>CARENATURA SENZA STAFFE (PASSO 3650mm) - STRATIFICAZIONE MANUALE - BIANCO FAIRING WITHOUT BRACKET (WHEEL BASE 3650mm) - G.R.P. - WHITE</p> <p>COS.PEL. ref. 806.03652 SIMILAR ref. 41225782 DX RH</p> <p>806.03651 Relativo kit staffe 1006.03652 41225781 SX LH</p> <p>Relativo kit staffe 1006.03651</p>
	<p>CARENATURA SENZA STAFFE (PASSO 3800mm) - STRATIFICAZIONE MANUALE - BIANCO FAIRING KIT WITHOUT BRACKETS (WHEEL BASE 3800mm) - G.R.P. - WHITE</p> <p>COS.PEL. ref. 806.03802 SIMILAR ref. - DX RH</p> <p>806.03801 Relativo kit staffe 1006.03652 - SX LH</p> <p>Relativo kit staffe 1006.03651</p>
	<p>CONVOGLIATORE ARIA P.P. AIR CONVEYOR P.P.</p> <p>COS.PEL. ref. 906.80162 SIMILAR ref. 504096162 DX RH</p> <p>906.80163 504096163 / 504203397 SX LH</p>
	<p>CERNIERA CALANDRA ANTERIORE P.P.G.F. BRACKET P.P.G.F.</p> <p>COS.PEL. ref. 1006.70604 SIMILAR ref. 500368694 / 504306106</p>
	<p>STAFFA PER RIPARO PEDANA METALLO BRACKET FOOTSTEP STEEL</p> <p>COS.PEL. ref. 1006.80178 SIMILAR ref. 504017178 DX RH</p> <p>1006.80177 504017177 SX LH</p>
	<p>GRIGLIA PEDANA PLASTICA FOOTSTEP GRILLE PLASTIC</p> <p>COS.PEL. ref. 1006.80540 SIMILAR ref. 504211437 DX RH</p> <p>1006.80541 Relativa pedana: 206.80540 / 206.90096 / 206.90098 504211438 SX LH</p> <p>Relativa pedana: 206.80541 / 206.90097 / 206.90099</p>
	<p>STAFFA RIPARO SOTTOPEDANA METALLO BRACKET PROTECTION FOOTSTEP STEEL</p> <p>COS.PEL. ref. 1006.80580 SIMILAR ref. 504017580</p>

Stralis AS

	<p>COPRI BATTERIA P.P. BATTERY COVER P.P.</p> <p>COS.PEL. ref. SIMILAR ref. 1006.90106 98474429</p>
	<p>BOTTONE PEDANA PARAURTI FRONT BUMPER CLIP</p> <p>COS.PEL. ref. SIMILAR ref. 1006.90110 504194581</p>
	<p>RIVESTIMENTO SOTTOPORTA CON INSERTI SIDE PANEL UNDER DOOR WITH INSERTS</p> <p>COS.PEL. ref. SIMILAR ref. 1406.80094 500370048 / 504045193 DX RH 1406.80095 500370049 / 504045194 SX LH</p>
	<p>PROLUNGA PORTA S.M.C. DOOR EXTENSION S.M.C.</p> <p>COS.PEL. ref. SIMILAR ref. 1406.80980 504044980 / 504211611 / 5801847591 DX RH 1406.80981 504044981 / 504211612 / 5801847596 SX LH</p>
	<p>RIVESTIMENTO LATERALE S.M.C. SIDE PANEL S.M.C.</p> <p>COS.PEL. ref. SIMILAR ref. 1406.80982 504022500 / 504081118 DX RH 1406.80983 504022499 / 504081120 SX LH</p>
	<p>RIVESTIMENTO LATERALE S.M.C. SIDE PANEL S.M.C.</p> <p>COS.PEL. ref. SIMILAR ref. 1406.80984 504022497 DX RH 1406.80985 504022498 SX LH</p>
	<p>PORTALAMPADA LAMP BULB HOLDER</p> <p>COS.PEL. ref. SIMILAR ref. 002987 -</p> <p>Per lampada / For lamp : 002988</p>
	<p>FANALINO LATERALE W5W SIDE LAMP W5W</p> <p>COS.PEL. ref. SIMILAR ref. 002988 41200664 DX-SX RH-LH</p> <p>Relativo portalampada 002987</p>

 	<p>FANALE LATERALE LAMPADINA ATTACCO AMP - JPT - Relativo connettore 003122 SIDE LAMP BULB CONNECTION AMP - JPT - Related connector 003122</p> <p>COS.PEL. ref. SIMILAR ref. 003001 500308514 DX-SX RH-LH</p> <p>ARANCIO / ORANGE - Relativo portalamпада 1601.50013</p>
	<p>PORTALAMPADA Relativo connettore 003122 (JPT) LAMP BULB HOLDER Related connector 003122 (JPT)</p> <p>COS.PEL. ref. SIMILAR ref. 1601.50013 -</p> <p>Per lampada / For lamp : 003001 / 003003 / 003004</p>
 	<p>FANALINO INGOMBRO CABINA DRIVER'S CAB SIDE MARKER</p> <p>COS.PEL. ref. SIMILAR ref. 1606.75604 504055623 DX RH</p> <p>1606.75603 504045133 SX LH</p>
 	<p>FANALINO CORNER LAMP</p> <p>COS.PEL. ref. SIMILAR ref. 1606.80040 41221040 / 42555022 DX RH</p> <p>1606.80041 41221041 / 42555023 SX LH</p>
 	<p>FANALINO LATERALE 2 FORI - GRIGIO CORNER LAMP 2 HOLES - GREY</p> <p>COS.PEL. ref. SIMILAR ref. 1606.80044 504098243 grigio / 504250999 DX RH nero</p> <p>1606.80045 504098245 grigio / 504250991 SX LH nero</p>
 	<p>FANALINO VISIERA 03 -> SUN VISOR' MARKER 03 -></p> <p>COS.PEL. ref. SIMILAR ref. 1606.80046 504047265 DX RH</p> <p>1606.80047 504047264 SX LH</p>
 	<p>FANALINO LATERALE 3 FORI - GRIGIO SIDE LAMP 3 HOLES - GREY</p> <p>COS.PEL. ref. SIMILAR ref. 1606.90602 41221039 GRIGIO / 504250984 DX RH NERO</p> <p>1606.90603 41221029 GRIGIO / 504250958 SX LH NERO</p> <p>Relativo portalamпада 1606.92811 - 003123 Relativo portalamпада 1606.92811 - 003123</p>
	<p>PORTALAMPADA LAMP BULB HOLDER</p> <p>COS.PEL. ref. SIMILAR ref. 1606.92811 -</p> <p>Per lampada / For lamp : 1606.90602/3</p>

Stralis AS

	<p>PROIETTORE H7 H7 - CORRETTORE ASSETTO MANUALE / ELETTRICO SENZA MOTORINO HEADLAMP H7 H7 - MANUAL LOAD LEVEL ADJUSTEMENT / ELECTRIC W/O MOTOR COS.PEL. ref. SIMILAR ref. 1606.80038 504020189 DX RH</p> <p>1606.80039 504020193 SX LH</p>
	<p>FENDINEBBIA ESTERNO H1 -> 07 OUTSIDE FOG LAMP H1 -> 07 COS.PEL. ref. SIMILAR ref. 1606.80042 504032145 DX-SX RH-LH</p>
	<p>FENDINEBBIA INTERNO H1 -> 07 INSIDE FOG LAMP H1 -> 07 COS.PEL. ref. SIMILAR ref. 1606.80043 504032148 DX-SX RH-LH</p>
	<p>SERRATURA PORTA ELETTRICA ELECTRIC DOOR LOCK COS.PEL. ref. SIMILAR ref. 1706.60906 98411951 / 98416419 DX RH</p> <p>1706.60905 98411952 / 98416424 SX LH</p>
	<p>ARRESTO PORTA DOOR STOP COS.PEL. ref. SIMILAR ref. 1706.60908 5802132946 / 99476267 DX RH</p> <p>1706.60907 5802132944 / 99476268 SX LH</p>
	<p>MANIGLIA PORTA NERO - CON CHIAVE DOOR HANDLE BLACK - WITH KEY COS.PEL. ref. SIMILAR ref. 1706.80800 - DX RH</p> <p>1706.80801 - SX LH</p>
	<p>KIT MANIGLIE PORTE CON CHIAVE NERO - CON CHIAVE KIT DOOR HANDLE WITH KEY BLACK - WITH KEY COS.PEL. ref. SIMILAR ref. 1706.80802 504052936 DX-SX RH-LH</p>
	<p>GUARNIZIONE PARABREZZA WINDSCREEN GASKET COS.PEL. ref. SIMILAR ref. 1806.44015 8143853</p>

	<p>GUIDA VETRO WINDOW FRAME</p> <p>COS.PEL. ref. SIMILAR ref. 1806.60134 98484152 DX RH</p> <p>1806.60133 98404902 SX LH</p>
	<p>ALZACRISTALLI ELETTRICO - CON MOTORINO - 2 PIN WINDOW REGULATOR ELECTRIC - WITH MOTOR - 2 PIN</p> <p>COS.PEL. ref. SIMILAR ref. 1906.60032 2997195 / 98407721 / 99487780 DX RH</p> <p>1906.60033 2997196 / 98407722 / 99487781 SX LH</p>
	<p>ALZACRISTALLI ELETTRICO - CON MOTORINO - 2 PIN WINDOW REGULATOR ELECTRIC - WITH MOTOR - 2 PIN</p> <p>COS.PEL. ref. SIMILAR ref. 1906.90030 504040988 / 504157968 / 5801324907 DX RH</p> <p>1906.90031 504040989 / 504157969 / 5801324893 SX LH</p>
<p>AD ESAURIMENTO SCORTE PARTS SELL-OUT</p> 	<p>VASCHETTA ESPANSIONE EXPANSION TANK</p> <p>COS.PEL. ref. SIMILAR ref. 2106.80080 41215631</p>
	<p>TIRANTE PARAFANGO GOMMA - NERO MUDGUARD TENSIONER RUBBER - BLACK</p> <p>COS.PEL. ref. SIMILAR ref. 1006.80696 2997670 / 41213696</p>
	<p>TIRANTE COPRI BATTERIA CORTO 140 mm MUDGUARD TENSIONER SHORT 140 mm</p> <p>COS.PEL. ref. SIMILAR ref. 1006.90107 4605163</p>
	<p>TIRANTE COPRI BATTERIA LUNGO 144 mm MUDGUARD TENSIONER LONG 144 mm</p> <p>COS.PEL. ref. SIMILAR ref. 1006.90109 4784894</p>
	<p>MOLLA A GAS Lunghezza [mm] 685 Corsa [mm] 295 Forza scarto [N] 260 GAS SPRING Lenght [mm] 685 Stroke [mm] 295 Waste force [N] 260</p> <p>COS.PEL. ref. SIMILAR ref. 2406.83100 500390551</p>

Stralis AS

	<p>DEFLETTORI LATERALI CON CLIPS SIDEWINDOW DEFLECTORS WITH CLIPS</p> <p>COS.PEL. ref. SIMILAR ref. 3006.00000 -</p>
	<p>KIT PER CONNESSIONI ELETTRICHE Connettore 2 vie JPT KIT FOR ELECTRICAL JOINTS Connector 2 ways JPT</p> <p>COS.PEL. ref. SIMILAR ref. 003122 -</p> <p>Connettore per 003001 - 003003 - 003004</p>
	<p>KIT PER CONNESSIONI ELETTRICHE Connettore SUPERSEAL 2 vie femmina KIT FOR ELECTRICAL JOINTS Connector SUPERSEAL ways female</p> <p>COS.PEL. ref. SIMILAR ref. 003123 -</p> <p>Connettore per la serie 1500.xxxxx</p>
 <p style="text-align: center;">15.2 cm</p>	<p>FANALE POSTERIORE LED - 24V - CONNETTORE POSTERIORE AMP 1.5 REAR-LIGHT LED - 24V - REAR CONNECTOR AMP 1.5</p> <p>COS.PEL. ref. SIMILAR ref. 1500.00000 - - Relativo connettore multipolare 003120 DX RH 1500.00001 - - Relativo connettore multipolare 003120 SX LH TRASPARENTE / LENS</p>



	<p>GRIGLIA P.P. / P.P.G.F. GRILLE P.P. / P.P.G.F.</p> <p>COS.PEL. ref. SIMILAR ref. 106.90200 504170979</p> <p>Relativa cerniera 1006.70604</p>
	<p>PEDANA PARAFANGO C/ALETTA S.M.C. - GRIGIO MUDGUARD FOOTSTEP S.M.C. - GREY</p> <p>COS.PEL. ref. SIMILAR ref. 206.70532 504047586 / 504103300 DX RH</p> <p>206.70533 504047585 / 504102299 SX LH</p>
	<p>COPERCHIO PARAFANGO POSTERIORE P.P. - GRIGIO - CON STAFFA COVER REAR MUDGUARD P.P. - GREY - WITH BRACKET</p> <p>COS.PEL. ref. SIMILAR ref. 206.80700 41218984 DX RH</p> <p>206.80701 41218983 SX LH</p>
	<p>COPERCHIO PARAFANGO POSTERIORE PARTE ANT. P.P. - GRIGIO COVER REAR MUDGUARD FRONT SIDE P.P. - GREY</p> <p>COS.PEL. ref. SIMILAR ref. 206.80702 41213720 DX RH</p> <p>206.80703 41213721 SX LH</p>
	<p>RIPARO ANTISPRAY Per 206.80751 MUDGUARD INNER For 206.80751</p> <p>COS.PEL. ref. SIMILAR ref. 206.80754 41299384 DX-SX RH-LH</p>

Nuovo Stralis 2007 AD - AT

	<p>RIPAROFANGO POSTERIORE P.P.T. - GRIGIO REAR MUDGUARD P.P.T. - GREY COS.PEL. ref. SIMILAR ref. 206.90100 504090861 DX RH</p> <p>206.90101 504090862 SX LH</p>
	<p>CALOTTA PARAF. POST. BASSA CON 4 TIRANTI P.P. - GRIGIO REAR MUDGUARD LOW WITH 4 M. TENSIONERS P.P. - GREY COS.PEL. ref. SIMILAR ref. 206.80747 2997670 / 41213696 / DX-SX RH-LH 41213751 (206.80749 versione senza i tiranti)</p>
	<p>CALOTTA PARAF.POST. CON 4 TIRANTI P.P. - GRIGIO REAR MUDGUARD WITH 4 MUDGUARD TENSIONERS P.P. - GREY COS.PEL. ref. SIMILAR ref. 206.80748 2997670 / 41213750 DX-SX RH-LH (206.80750 versione senza i tiranti)</p>
	<p>CALOTTA PARAFANGO POSTERIORE BASSA P.P. - GRIGIO REAR MUDGUARD P.P. - GREY COS.PEL. ref. SIMILAR ref. 206.80749 41213751 DX-SX RH-LH Relativo tirante 1006.80696 - (206.80747 versione con i tiranti)</p>
	<p>CALOTTA PARAFANGO POSTERIORE P.P. - GRIGIO REAR MUDGUARD P.P. - GREY COS.PEL. ref. SIMILAR ref. 206.80750 41213750 DX-SX RH-LH Relativo tirante 1006.80696 - (206.80748 versione con i tiranti)</p>
	<p>MEZZO PARAFANGO POSTERIORE PARTE POSTERIORE (STAFFA INTERNA LUNGA) - P.P. - GRIGIO REAR MUDGUARD REAR SIDE (LONG INTERNAL BRACKET) - P.P. - GREY COS.PEL. ref. SIMILAR ref. 206.80751 41213754 DX-SX RH-LH Staffa interna lunga - Relativo antispray 206.80754</p>
	<p>MEZZO PARAFANGO POSTERIORE PARTE ANTERIORE (STAFFA INTERNA CORTA) - P.P. - GRIGIO REAR MUDGUARD FRONT SIDE (SHORT INTERNAL BRACKET) - P.P. - GREY COS.PEL. ref. SIMILAR ref. 206.80752 41213753 DX-SX RH-LH Staffa interna corta</p>
	<p>MEZZO PARAFANGO POSTERIORE SENZA STAFFE SENZA STAFFE - P.P. - GRIGIO REAR MUDGUARD W/O BRACKETS WITHOUT BRACKETS - P.P. - GREY COS.PEL. ref. SIMILAR ref. 206.80753 - DX-SX RH-LH Senza staffe - Relativo antispray 206.80754</p>

Nuovo Stralis 2007 AD - AT

	<p>PEDANA SUPERIORE P.P.G.F. - NERO UPPER FOOTSTEP P.P.G.F. - BLACK COS.PEL. ref. SIMILAR ref. 306.80018 504001361 / 504217554 nero DX RH</p> <p>306.80019 504001358 / 504217553 nero SX LH</p>
	<p>PEDANA INFERIORE P.P.G.F. - NERO LOWER FOOTSTEP P.P.G.F. - BLACK COS.PEL. ref. SIMILAR ref. 306.80020 504001345 / 504217526 nero DX RH</p> <p>306.80021 504001344 / 504217525 nero SX LH</p>
	<p>PEDANA P.P.G.F. - NERA - PER PARAURTI IN FERRO FOOTSTEP P.P.G.F. - BLACK - FOR IRON BUMPER COS.PEL. ref. SIMILAR ref. 306.80010 2997741 / 504136562 DX RH</p> <p>306.80011 2997740 / 504136561 SX LH</p>
	<p>PEDANA CON FORI MODANATURA P.P.G.F. - NERO FOOTSTEP WITH HOLES P.P.G.F. - BLACK COS.PEL. ref. SIMILAR ref. 306.80012 2997739 / 504136556 / 504368383 DX RH</p> <p>306.80013 2997738 / 504136555 / 504368379 SX LH</p>
	<p>PEDANA PER PARAURTI IN FERRO SENZA FORI P.P.G.F. - GRIGIO - PER PARAURTI IN FERRO FOOTSTEP FOR BUMPER P.P.G.F. - GREY - FOR IRON BUMPER COS.PEL. ref. SIMILAR ref. 306.80014 2997579 / 504215973 grigio / 504368370 nero DX RH</p> <p>306.80015 2997578 / 504215971 grigio / 504368371 nero SX LH</p>
	<p>PEDANA P.P.G.F. - BIANCO SMALTATO FOOTSTEP P.P.G.F. - WHITE ENAMELLED COS.PEL. ref. SIMILAR ref. 306.80026 2997119 / 500375431 DX RH</p> <p>306.80027 2997119 / 500375431 SX LH</p> <p>306.80030 : ROSSO MARANELLO 306.80031 : ROSSO MARANELLO</p>
	<p>PARAURTI ANTERIORE P.P.T./P.P.G.F. - BIANCO SMALTATO FRONT BUMPER P.P.T./P.P.G.F. - WHITE ENAMELLED COS.PEL. ref. SIMILAR ref. 406.90080 504186932 / 504284316 / 5801603586</p> <p>406.90078 : ROSSO MARANELLO 406.90077 : NERO OPACO</p>
	<p>PARAURTI ANTERIORE P.P.T./P.P.G.F. - NERO (NON VERNICIATO) FRONT BUMPER P.P.T./P.P.G.F. - BLACK (NO PAINTED) COS.PEL. ref. SIMILAR ref. 406.90086 504186932 / 504284316</p>

Nuovo Stralis 2007 AD - AT

	<p>PARAURTI ANTERIORE P.P.T./P.P.G.F. - PRIMER FRONT BUMPER P.P.T./P.P.G.F. - PRIMER</p> <p>COS.PEL. ref. SIMILAR ref. 406.90091 504186932 / 504284316 / 5801603586</p>
	<p>SOTTOPARAURTI P.P. - PRIMER CORNER SPOILER P.P. - PRIMER</p> <p>COS.PEL. ref. SIMILAR ref. 406.90082 504190780 DX RH</p> <p>406.90083 504190781 SX LH</p>
	<p>SOTTOPARAURTI CENTRALE P.P. - PRIMER CENTRAL SPOILER P.P. - PRIMER</p> <p>COS.PEL. ref. SIMILAR ref. 406.90084 504190747</p>
	<p>SOTTOPARAURTI CENTRALE P.P. - NERO CENTRAL SPOILER P.P. - BLACK</p> <p>COS.PEL. ref. SIMILAR ref. 406.90087 504190697</p>
	<p>SOTTOPARAURTI P.P. - NERO CORNER SPOILER P.P. - BLACK</p> <p>COS.PEL. ref. SIMILAR ref. 406.90088 504190699 DX RH</p> <p>406.90089 504190700 SX LH</p>
	<p>SPORTELLLO CENTRALE PARAURTI A.B.S. - NERO CENTRAL COVER BUMPER A.B.S. - BLACK</p> <p>COS.PEL. ref. SIMILAR ref. 406.90092 504187294</p>
	<p>TAPPO PARAURTI P.P. - NERO BUMPER COVER P.P. - BLACK</p> <p>COS.PEL. ref. SIMILAR ref. 406.90093 504187339</p>
	<p>SPORTELLLO SUPERIORE PARAURTI P.P. - NERO UPPER BUMPER COVER P.P. - BLACK</p> <p>COS.PEL. ref. SIMILAR ref. 406.90094 504187426 DX RH</p> <p>406.90095 504187427 SX LH</p>





Nuovo Stralis 2007 AD - AT

	<p>SPORTELLLO LATERALE PARAURTI P.P. - NERO SIDE BUMPER COVER P.P. - BLACK COS.PEL. ref. SIMILAR ref. 406.90096 504187506 DX RH</p> <p>406.90097 504187507 SX LH</p>
	<p>SUPPORTO FENDI INTERNO P.P.G.F. - NERO FOG LAMP BRACKET P.P.G.F. - BLACK COS.PEL. ref. SIMILAR ref. 406.90098 504173478 DX RH</p> <p>406.90099 504173477 SX LH</p>
	<p>PEDANA PARAURTI P.P. - NERO UPPER BUMPER FOOTSTEP P.P. - BLACK COS.PEL. ref. SIMILAR ref. 406.90102 500380111 / 504032325 / 504194669</p>
	<p>PEDANA PARAURTI P.P. - NERO UPPER BUMPER FOOTSTEP P.P. - BLACK COS.PEL. ref. SIMILAR ref. 406.90103 504135514</p>
	<p>CORNICE FENDINEBBIA P.P. - NERO FOG LAMP FRAME P.P. - BLACK COS.PEL. ref. SIMILAR ref. 406.90104 504187939 DX RH</p> <p>406.90105 504187940 SX LH</p>
	<p>CORNICE FENDI APERTO LAVAFARO CHIUSO A.B.S. - GRIGIO FOG LAMP BUMPER FRAME A.B.S. - GREY COS.PEL. ref. SIMILAR ref. 406.90106 - DX RH</p> <p>406.90107 - SX LH</p>
	<p>PROTEZIONE PARAURTI LATERALE LATERAL PROTECTION BUMPER COS.PEL. ref. SIMILAR ref. 406.90108 504008290 / 504194532 DX RH</p> <p>406.90109 504194533 SX LH</p>
	<p>SPECCHIO RETROVISORE ELETTRICO - RISCALDATO - BRACCIO MEDIO REAR-VIEW MIRROR ELECTRIC - HEATED - MEDIUM ARM COS.PEL. ref. SIMILAR ref. 506.90098 504370055 / 5801336298 / 5801580230 DX RH</p> <p>506.90099 504370048 / 5801336285 SX LH</p>

Nuovo Stralis 2007 AD - AT

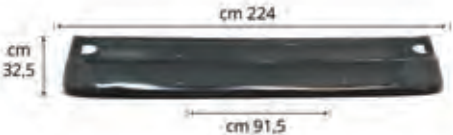
	<p>VETRO SPECCHIO RISCALDATO MIRROR GLASS HEATED</p> <p>COS.PEL. ref. 506.90102 SIMILAR ref. 504197878</p> <p style="text-align: right;">DX-SX RH-LH</p>
	<p>VETRO SPECCHIO GRANDANGOLO - RISCALDATO - RAGGIO 300 MIRROR GLASS WIDE ANGLE - HEATED - RADIUS 300</p> <p>COS.PEL. ref. 506.90103 SIMILAR ref. 504197879</p> <p style="text-align: right;">DX-SX RH-LH</p>
	<p>COPERCHIO RETROVISORE COVER MIRROR</p> <p>COS.PEL. ref. 506.90104 SIMILAR ref. 504158975</p> <p style="text-align: right;">DX RH</p> <p>506.90105 504158974 SX LH</p>
	<p>COPERCHIO RETROVISORE GRANDANGOLO COVER MIRROR WIDE ANGLE</p> <p>COS.PEL. ref. 506.90106 SIMILAR ref. 504158977</p> <p style="text-align: right;">DX RH</p> <p>506.90107 504158976 SX LH</p>
	<p>SPECCHIO GUARDARUOTA RISCALDATO - MANUALE - RAGGIO 300 ROOF MIRROR HEATED - MANUAL - RADIUS 300</p> <p>COS.PEL. ref. 506.90108 SIMILAR ref. 504168236 / 5801765379</p> <p style="text-align: right;">DX RH</p>
	<p>PLASTICA COPRIBRACCIO PLASTIC COVER ARM</p> <p>COS.PEL. ref. 506.90109 SIMILAR ref. 504168244</p>
	<p>SPECCHIO FRONTALE RISCALDATO FRONT MIRROR HEATED</p> <p>COS.PEL. ref. 506.90110 SIMILAR ref. 504224428 / 5801806044</p> <p style="text-align: right;">DX RH</p>
	<p>PLASTICA COPRIBRACCIO SUPERIORE A.B.S. - NERO UPPER MIRROR ARM COVER A.B.S. - BLACK</p> <p>COS.PEL. ref. 506.90112 SIMILAR ref. 504158943</p> <p style="text-align: right;">DX RH</p> <p>506.90113 504158937 SX LH</p>

Nuovo Stralis 2007 AD - AT

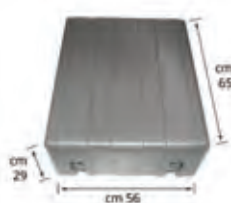
	<p>PLASTICA COPRIBRACCIO INFERIORE A.B.S. - NERO LOWER MIRROR ARM COVER A.B.S. - BLACK COS.PEL. ref. SIMILAR ref. 506.90114 504158951 / 504369796 DX RH</p> <p>506.90111 504158947 / 504369798 SX LH</p>
	<p>VISIERA STRALIS AD-AT 1a serie SENZA STAFFE SUN VISOR STRALIS AD-AT 1st series W/O BRACKETS</p> <p>COS.PEL. ref. SIMILAR ref. 706.70600 504056838 / 504089372</p> <p>Relativo kit staffe 1006.70600</p>
	<p>GRIGLIA PEDANA PLASTICA FOOTSTEP GRILLE PLASTIC COS.PEL. ref. SIMILAR ref. 1006.70532 504242345 DX RH</p> <p>1006.70533 504242346 SX LH</p> <p>Relativa pedana: 206.70530 / 206.70532 / 206.93202 / 206.93204 Relativa pedana: 206.70531 / 206.70533 / 206.93203 / 206.93205</p>
	<p>CERNIERA CALANDRA ANTERIORE P.P.G.F. BRACKET P.P.G.F.</p> <p>COS.PEL. ref. SIMILAR ref. 1006.70604 500368694 / 504306106</p>
	<p>SUPPORTO PARAURTI METALLO SUPPORT BRACKET STEEL COS.PEL. ref. SIMILAR ref. 1006.90100 504022657 DX RH</p> <p>1006.90101 504022658 SX LH</p>
	<p>SUPPORTO PARAFANGO POST. PARTE POST. METALLO REAR SUPPORT MUDGUARDE REAR SIDE STEEL COS.PEL. ref. SIMILAR ref. 1006.90102 41213731 DX RH</p> <p>1006.90103 41213729 SX LH</p>
	<p>SUPPORTO PARAFANGO POST. PARTE ANT. METALLO REAR SUPPORT MUDGUARD FRONT SIDE STEEL COS.PEL. ref. SIMILAR ref. 1006.90104 41213727 DX RH</p> <p>1006.90105 41213725 SX LH</p>
	<p>COPRI BATTERIA P.P. BATTERY COVER P.P.</p> <p>COS.PEL. ref. SIMILAR ref. 1006.90106 98474429</p>

Nuovo Stralis 2007 AD - AT



SUPPORTO MOLLA GAS

P.P.G.F.
GAS SPRING SUPPORT
P.P.G.F.

COS.PEL. ref. SIMILAR ref.
1006.90108 500396838



BOTTONE PEDANA PARAURTI

FRONT BUMPER CLIP

COS.PEL. ref. SIMILAR ref.
1006.90110 504194581



DOPPIA VITE M6

SCREW M6

COS.PEL. ref. SIMILAR ref.
1006.90187 504171187



DOPPIA VITE M8

SCREW M8

COS.PEL. ref. SIMILAR ref.
1006.90483 504173483



MOLLETTA

CLIP

COS.PEL. ref. SIMILAR ref.
1006.90487 504173487



ELASTICO

ELASTIC

COS.PEL. ref. SIMILAR ref.
1006.90916 504256916



PORTALAMPADA

LAMP BULB HOLDER

COS.PEL. ref. SIMILAR ref.
002987 -
Per lampada / For lamp : 002988



FANALINO LATERALE















W5W
SIDE LAMP
W5W

COS.PEL. ref. SIMILAR ref.
002988 41200664

DX-SX RH-LH

Relativo portalampada 002987

Nuovo Stralis 2007 AD - AT

 	<p>FANALINO VISIERA 03 -> SUN VISOR' MARKER 03 -> COS.PEL. ref. SIMILAR ref. 1606.80046 504047265 DX RH</p> <p>1606.80047 504047264 SX LH</p>
 	<p>FANALINO LATERALE 3 FORI - GRIGIO SIDE LAMP 3 HOLES - GREY COS.PEL. ref. SIMILAR ref. 1606.90602 41221039 GRIGIO / 504250984 DX RH NERO Relativo portalamпада 1606.92811 - 003123 1606.90603 41221029 GRIGIO / 504250958 SX LH NERO Relativo portalamпада 1606.92811 - 003123</p>
 	<p>FANALINO ANTERIORE FRONT CORNER LAMP COS.PEL. ref. SIMILAR ref. 1606.90604 42555041 / 5801755123 DX RH</p> <p>Relativo portalamпада 1606.92810 1606.90605 42555042 / 5801755132 SX LH Relativo portalamпада 1606.92810</p>
	<p>PORTALAMPADA LAMP BULB HOLDER COS.PEL. ref. SIMILAR ref. 1606.92810 -</p> <p>Per / For : 1606.92802/3 - 1606.90604/5 - 1604.10604/5</p>
	<p>PORTALAMPADA LAMP BULB HOLDER COS.PEL. ref. SIMILAR ref. 1606.92811 -</p> <p>Per lampada / For lamp : 1606.90602/3</p>
 	<p>PROIETTORE H7 H7 - 08-> - CORRETTORE ASSETTO MANUALE HEADLAMP H7 H7 - 08-> - MANUAL LOAD LEVEL ADJUSTEMENT COS.PEL. ref. SIMILAR ref. 1606.90600 504238093 DX RH</p> <p>1606.90601 504238117 SX LH</p>
 	<p>PROIETTORE FENDINEBBIA ESTERNO H1 - 08 -> OUTSIDE FOG LAMP H1 - 08 -> COS.PEL. ref. SIMILAR ref. 1606.90606 504181095 DX-SX RH-LH</p>
 	<p>PROIETTORE PROFONDITA' INTERNO H1 - 08 -> INNER LAMP H1 - 08 -> COS.PEL. ref. SIMILAR ref. 1606.90607 504181096 DX-SX RH-LH</p>

Nuovo Stralis 2007 AD - AT

	<p>SERRATURA PORTA ELETTRICA ELECTRIC DOOR LOCK</p> <p>COS.PEL. ref. 1706.60906 SIMILAR ref. 98411951 / 98416419 DX RH</p> <p>1706.60905 98411952 / 98416424 SX LH</p>
	<p>ARRESTO PORTA DOOR STOP</p> <p>COS.PEL. ref. 1706.60908 SIMILAR ref. 5802132946 / 99476267 DX RH</p> <p>1706.60907 5802132944 / 99476268 SX LH</p>
	<p>GUIDA VETRO WINDOW FRAME</p> <p>COS.PEL. ref. 1806.60134 SIMILAR ref. 98484152 DX RH</p> <p>1806.60133 98404902 SX LH</p>
	<p>ALZACRISTALLI ELETTRICO - CON MOTORINO - 2 PIN WINDOW REGULATOR ELECTRIC - WITH MOTOR - 2 PIN</p> <p>COS.PEL. ref. 1906.60032 SIMILAR ref. 2997195 / 98407721 / 99487780 DX RH</p> <p>1906.60033 2997196 / 98407722 / 99487781 SX LH</p>
	<p>ALZACRISTALLI ELETTRICO - CON MOTORINO - 2 PIN WINDOW REGULATOR ELECTRIC - WITH MOTOR - 2 PIN</p> <p>COS.PEL. ref. 1906.90030 SIMILAR ref. 504040988 / 504157968 / 5801324907 DX RH</p> <p>1906.90031 504040989 / 504157969 / 5801324893 SX LH</p>
<p>AD ESAURIMENTO SCORTE UNTIL SHLL-OUT</p> 	<p>VASCHETTA ESPANSIONE EXPANSION TANK</p> <p>COS.PEL. ref. 2106.80080 SIMILAR ref. 41215631</p>
 <p>cm 14</p>	<p>TIRANTE COPRI BATTERIA CORTO 140 mm MUDGUARD TENSIONER SHORT 140 mm</p> <p>COS.PEL. ref. 1006.90107 SIMILAR ref. 4605163</p>
 <p>cm 14,4</p>	<p>TIRANTE COPRI BATTERIA LUNGO 144 mm MUDGUARD TENSIONER LONG 144 mm</p> <p>COS.PEL. ref. 1006.90109 SIMILAR ref. 4784894</p>

Nuovo Stralis 2007 AD - AT

	<p>DEFLETTORI LATERALI CON CLIPS SIDEWINDOW DEFLECTORS WITH CLIPS</p> <p>COS.PEL. ref. SIMILAR ref. 3006.00000 -</p>
	<p>KIT PER CONNESSIONI ELETTRICHE Connettore HDSCS singolo KIT FOR ELECTRICAL JOINTS Connector HDSCS simple</p> <p>COS.PEL. ref. SIMILAR ref. 003119 -</p>
	<p>KIT PER CONNESSIONI ELETTRICHE Connettore SUPERSEAL 2 vie femmina KIT FOR ELECTRICAL JOINTS Connector SUPERSEAL ways female</p> <p>COS.PEL. ref. SIMILAR ref. 003123 -</p> <p>Connettore per la serie 1500.xxxxx</p>
	<p>FANALE POSTERIORE LED - 24V - CONNETTORE POSTERIORE AMP 1.5 REAR-LIGHT LED - 24V - REAR CONNECTOR AMP 1.5</p> <p>COS.PEL. ref. SIMILAR ref. 1500.00000 - DX RH 1500.00001 - Relativo connettore multipolare 003120 SX LH TRASPARENTE / LENS Relativo connettore multipolare 003120</p>
	<p>FANALE POSTERIORE LED - 24V - CONNETTORE LATERALE HDSCS REAR-LIGHT LED - 24V - LATERAL CONNECTOR HDSCS</p> <p>COS.PEL. ref. SIMILAR ref. 1506.92000 5802000573 DX RH 1506.92001 Relativo connettore 003119 SX LH TRASPARENTE / LENS Relativo connettore 003119 1503.45100 - DX RH 1503.45101 - SX LH</p>
	<p>FANALE POSTERIORE LED - 24V - CONNETTORE LATERALE HDSCS REAR-LIGHT LED - 24V - LATERAL CONNECTOR HDSCS</p> <p>COS.PEL. ref. SIMILAR ref. 1506.92002 5802000767 DX RH 1506.92003 Con cicalino / With buzzer - Relativo connettore 003119 SX LH TRASPARENTE / LENS Con luce targa / With plate light - Relativo connettore 003119 1503.45100 - DX RH 1503.45101 - SX LH</p>
	<p>FANALE POSTERIORE LED - 24V - CONNETTORE POSTERIORE HDSCS REAR-LIGHT LED - 24V - REAR CONNECTOR HDSCS</p> <p>COS.PEL. ref. SIMILAR ref. 1506.92004 5802000770 DX RH 1506.92005 Relativo connettore 003119 SX LH TRASPARENTE / LENS Relativo connettore 003119 1503.45100 - DX RH 1503.45101 - SX LH</p>
	<p>FANALE POSTERIORE LED - 24V - CONNETTORE POSTERIORE HDSCS REAR-LIGHT LED - 24V - REAR CONNECTOR HDSCS</p> <p>COS.PEL. ref. SIMILAR ref. 1506.92006 5802000772 DX RH 1506.92007 Con cicalino / With buzzer - Relativo connettore 003119 SX LH TRASPARENTE / LENS Con luce targa / With plate light - Relativo connettore 003119 1503.45100 - DX RH 1503.45101 - SX LH</p>

ALL ITEMS MENTIONED IN OUR CATALOGUE ARE NOT ORIGINAL PARTS BUT PERFECTLY INTERCHANGEABLE WITH THEM.

GOVERNING LEGISLATIONS FOR THE SALE OF OUR PRODUCTS DIFFER IN EACH COUNTRY.

INFRINGEMENTS, IF ANY, OF LOCAL LEGISLATIONS ARE RESPONSIBILITY OF THE RETAILER IN THE COUNTRY OF FINAL DISTRIBUTION.



Nuovo Stralis 2007 AS



COS.IVE

	<p>GRIGLIA P.P. / P.P.G.F. GRILLE P.P. / P.P.G.F.</p> <p>COS.PEL. ref. SIMILAR ref. 106.90100 504170809 / 504170848</p> <p>Relativa cerniera 1006.70604</p>
	<p>COPERCHIO PARAFANGO POSTERIORE P.P. - GRIGIO - CON STAFFA COVER REAR MUDGUARD P.P. - GREY - WITH BRACKET</p> <p>COS.PEL. ref. SIMILAR ref. 206.80700 41218984 DX RH</p> <p>206.80701 41218983 SX LH</p>
	<p>COPERCHIO PARAFANGO POSTERIORE PARTE ANT. P.P. - GRIGIO COVER REAR MUDGUARD FRONT SIDE P.P. - GREY</p> <p>COS.PEL. ref. SIMILAR ref. 206.80702 41213720 DX RH</p> <p>206.80703 41213721 SX LH</p>
	<p>RIPARO ANTISPRAY Per 206.80751 MUDGUARD INNER For 206.80751</p> <p>COS.PEL. ref. SIMILAR ref. 206.80754 41299384 DX-SX RH-LH</p>
	<p>PEDANA PARAFANGO S.M.C. - NERO - CON FORI MODANATURA + PORTAOGGETTI MUDGUARD FOOTSTEP S.M.C. - BLACK - WITH HOLES</p> <p>COS.PEL. ref. SIMILAR ref. 206.90096 504132808 / 504132811 / 5801840558 / 5801840561 DX RH</p> <p>206.90097 504211219 / 5801840565 SX LH</p>

Nuovo Stralis 2007 AS

	<p>PEDANA PARAFANGO S.M.C. NERO - CON FORO PORTAOGGETTI MUDGUARD FOOTSTEP S.M.C. - BLACK - WITH HOLE COS.PEL. ref. SIMILAR ref. 206.90098 504020073 / 504103308 / 5801840545 DX RH</p> <p>206.90099 500375472 / 504103305 / 5801840550 SX LH</p>
	<p>RIPAROFANGO POSTERIORE P.P.T. - GRIGIO REAR MUDGUARD P.P.T. - GREY COS.PEL. ref. SIMILAR ref. 206.90100 504090861 DX RH</p> <p>206.90101 504090862 SX LH</p>
	<p>CALOTTA PARAF. POST. BASSA CON 4 TIRANTI P.P. - GRIGIO REAR MUDGUARD LOW WITH 4 M. TENSIONERS P.P. - GREY COS.PEL. ref. SIMILAR ref. 206.80747 2997670 / 41213696 / 41213751 DX-SX RH-LH (206.80749 versione senza i tiranti)</p>
	<p>CALOTTA PARAF.POST. CON 4 TIRANTI P.P. - GRIGIO REAR MUDGUARD WITH 4 MUDGUARD TENSIONERS P.P. - GREY COS.PEL. ref. SIMILAR ref. 206.80748 2997670 / 41213750 DX-SX RH-LH (206.80750 versione senza i tiranti)</p>
	<p>CALOTTA PARAFANGO POSTERIORE BASSA P.P. - GRIGIO REAR MUDGUARD P.P. - GREY COS.PEL. ref. SIMILAR ref. 206.80749 41213751 DX-SX RH-LH Relativo tirante 1006.80696 - (206.80747 versione con i tiranti)</p>
	<p>CALOTTA PARAFANGO POSTERIORE P.P. - GRIGIO REAR MUDGUARD P.P. - GREY COS.PEL. ref. SIMILAR ref. 206.80750 41213750 DX-SX RH-LH Relativo tirante 1006.80696 - (206.80748 versione con i tiranti)</p>
	<p>MEZZO PARAFANGO POSTERIORE PARTE POSTERIORE (STAFFA INTERNA LUNGA) - P.P. - GRIGIO REAR MUDGUARD REAR SIDE (LONG INTERNAL BRACKET) - P.P. - GREY COS.PEL. ref. SIMILAR ref. 206.80751 41213754 DX-SX RH-LH Staffa interna lunga - Relativo antispray 206.80754</p>
	<p>MEZZO PARAFANGO POSTERIORE PARTE ANTERIORE (STAFFA INTERNA CORTA) - P.P. - GRIGIO REAR MUDGUARD FRONT SIDE (SHORT INTERNAL BRACKET) - P.P. - GREY COS.PEL. ref. SIMILAR ref. 206.80752 41213753 DX-SX RH-LH Staffa interna corta</p>

Nuovo Stralis 2007 AS

 <p>cm 70,5 cm 68</p>	<p>MEZZO PARAFANGO POSTERIORE SENZA STAFFE SENZA STAFFE - P.P. - GRIGIO REAR MUDGUARD W/O BRACKETS WITHOUT BRACKETS - P.P. - GREY</p> <p>COS.PEL. ref. SIMILAR ref. 206.80753 -</p> <p style="text-align: right;">DX-SX RH-LH</p> <p style="text-align: right;">Senza staffe - Relativo antispray 206.80754</p>
	<p>PEDANA CON FORI MODANATURA P.P.G.F. - NERO FOOTSTEP WITH HOLES P.P.G.F. - BLACK</p> <p>COS.PEL. ref. SIMILAR ref. 306.80012 2997739 / 504136556 / 504368383 DX RH</p> <p>306.80013 2997738 / 504136555 / 504368379 SX LH</p>
	<p>PEDANA P.P.G.F. - BIANCO SMALTATO FOOTSTEP P.P.G.F. - WHITE ENAMELLED</p> <p>COS.PEL. ref. SIMILAR ref. 306.80026 2997119 / 500375431 DX RH</p> <p>306.80027 306.80030 : ROSSO MARANELLO 2997119 / 500375431 SX LH</p> <p style="text-align: right;">306.80031 : ROSSO MARANELLO</p>
	<p>PARAURTI ANTERIORE P.P.T./P.P.G.F. - BIANCO SMALTATO FRONT BUMPER P.P.T./P.P.G.F. - WHITE ENAMELLED</p> <p>COS.PEL. ref. SIMILAR ref. 406.90081 504186929 / 504284315 / 5801603578 / 5801603597</p> <p style="text-align: right;">406.90079 : ROSSO MARANELLO 406.90076 : NERO OPACO</p>
	<p>PARAURTI ANTERIORE P.P.T./P.P.G.F. - NERO (NON VERNICIATO) FRONT BUMPER P.P.T./P.P.G.F. - BLACK (NO PAINT)</p> <p>COS.PEL. ref. SIMILAR ref. 406.90085 504186928 / 504287143</p>
	<p>PARAURTI ANTERIORE P.P.T./P.P.G.F. - PRIMER FRONT BUMPER P.P.T./P.P.G.F. - PRIMER</p> <p>COS.PEL. ref. SIMILAR ref. 406.90090 504186929 / 504284315 / 5801603578 / 5801603597</p>
	<p>SOTTOPARAURTI P.P. - PRIMER CORNER SPOILER P.P. - PRIMER</p> <p>COS.PEL. ref. SIMILAR ref. 406.90082 504190780 DX RH</p> <p>406.90083 504190781 SX LH</p>
	<p>SOTTOPARAURTI CENTRALE P.P. - PRIMER CENTRAL SPOILER P.P. - PRIMER</p> <p>COS.PEL. ref. SIMILAR ref. 406.90084 504190747</p>





	<p>SOTTOPARAURTI CENTRALE P.P. - NERO CENTRAL SPOILER P.P. - BLACK</p> <p>COS.PEL. ref. SIMILAR ref. 406.90087 504190697</p>
	<p>SOTTOPARAURTI P.P. - NERO CORNER SPOILER P.P. - BLACK</p> <p>COS.PEL. ref. SIMILAR ref. 406.90088 504190699 DX RH</p> <p>406.90089 504190700 SX LH</p>
	<p>SPORTELLO CENTRALE PARAURTI A.B.S. - NERO CENTRAL COVER BUMPER A.B.S. - BLACK</p> <p>COS.PEL. ref. SIMILAR ref. 406.90092 504187294</p>
	<p>TAPPO PARAURTI P.P. - NERO BUMPER COVER P.P. - BLACK</p> <p>COS.PEL. ref. SIMILAR ref. 406.90093 504187339</p>
	<p>SPORTELLO SUPERIORE PARAURTI P.P. - NERO UPPER BUMPER COVER P.P. - BLACK</p> <p>COS.PEL. ref. SIMILAR ref. 406.90094 504187426 DX RH</p> <p>406.90095 504187427 SX LH</p>
	<p>SPORTELLO LATERALE PARAURTI P.P. - NERO SIDE BUMPER COVER P.P. - BLACK</p> <p>COS.PEL. ref. SIMILAR ref. 406.90096 504187506 DX RH</p> <p>406.90097 504187507 SX LH</p>
	<p>SUPPORTO FENDI INTERNO P.P.G.F. - NERO FOG LAMP BRACKET P.P.G.F. - BLACK</p> <p>COS.PEL. ref. SIMILAR ref. 406.90098 504173478 DX RH</p> <p>406.90099 504173477 SX LH</p>
	<p>CORNICE FENDINEBBIA P.P. - PRIMER FOG LAMP FRAME P.P. - PRIMER</p> <p>COS.PEL. ref. SIMILAR ref. 406.90100 504188129 DX RH</p> <p>406.90101 504188130 SX LH</p>

Nuovo Stralis 2007 AS

	<p>PEDANA PARAURTI P.P. - NERO UPPER BUMPER FOOTSTEP P.P. - BLACK</p> <p>COS.PEL. ref. SIMILAR ref. 406.90102 500380111 / 504032325 / 504194669</p>
	<p>PEDANA PARAURTI P.P. - NERO UPPER BUMPER FOOTSTEP P.P. - BLACK</p> <p>COS.PEL. ref. SIMILAR ref. 406.90103 504135514</p>
	<p>SPECCHIO RETROVISORE ELETRICO - RISCALDATO - BRACCIO CORTO REAR-VIEW MIRROR RH ELECTRIC - HEATED</p> <p>COS.PEL. ref. SIMILAR ref. 506.90100 504150527 / 504369961 / 580176196 DX RH</p> <p>506.90101 504150526 / 504369910 / 580176195 SX LH</p>
	<p>VETRO SPECCHIO RISCALDATO MIRROR GLASS HEATED</p> <p>COS.PEL. ref. SIMILAR ref. 506.90102 504197878 DX-SX RH-LH</p>
	<p>VETRO SPECCHIO GRANDANGOLO - RISCALDATO - RAGGIO 300 MIRROR GLASS WIDE ANGLE - HEATED - RADIUS 300</p> <p>COS.PEL. ref. SIMILAR ref. 506.90103 504197879 DX-SX RH-LH</p>
	<p>COPERCHIO RETROVISORE COVER MIRROR</p> <p>COS.PEL. ref. SIMILAR ref. 506.90104 504158975 DX RH</p> <p>506.90105 504158974 SX LH</p>
	<p>COPERCHIO RETROVISORE GRANDANGOLO COVER MIRROR WIDE ANGLE</p> <p>COS.PEL. ref. SIMILAR ref. 506.90106 504158977 DX RH</p> <p>506.90107 504158976 SX LH</p>
	<p>SPECCHIO GUARDARUOTA RISCALDATO - MANUALE - RAGGIO 300 ROOF MIRROR HEATED - MANUAL - RADIUS 300</p> <p>COS.PEL. ref. SIMILAR ref. 506.90108 504168236 / 5801765379 DX RH</p>















	<p>PLASTICA COPRIBRACCIO PLASTIC COVER ARM</p> <p>COS.PEL. ref. 506.90109 SIMILAR ref. 504168244</p>
	<p>SPECCHIO FRONTALE RISCALDATO FRONT MIRROR HEATED</p> <p>COS.PEL. ref. 506.90110 SIMILAR ref. 504224428 / 5801806044 DX RH</p>
	<p>PLASTICA COPRIBRACCIO SUPERIORE A.B.S. - NERO UPPER MIRROR ARM COVER A.B.S. - BLACK</p> <p>COS.PEL. ref. 506.90112 SIMILAR ref. 504158943 DX RH</p> <p>506.90113 504158937 SX LH</p>
	<p>PLASTICA COPRIBRACCIO INFERIORE A.B.S. - NERO LOWER MIRROR ARM COVER A.B.S. - BLACK</p> <p>COS.PEL. ref. 506.90114 SIMILAR ref. 504158951 / 504369796 DX RH</p> <p>506.90111 504158947 / 504369798 SX LH</p>
	<p>SPOILER TETTO MOBILE Euro 5/6 SPOILER Euro 5/6</p> <p>COS.PEL. ref. 606.92300 SIMILAR ref. 5801592113</p> <p>Solo ricambistica, kit staffe non fornito</p>
	<p>VISIERA STRALIS AS 2007 SENZA STAFFE SUN VISOR STRALIS AS 2007 WITHOUT BRACKET KIT</p> <p>COS.PEL. ref. 706.90800 SIMILAR ref. 504146434 / 504146530 con staffe Relativo kit staffe / Bracket kit : 1006.90800</p>
	<p>CARENATURA SENZA STAFFE PASSO 3600 - EURO 5 FAIRING WITHOUT BRACKET WHEEL BASE 3600 - EURO 5</p> <p>COS.PEL. ref. 806.90362 SIMILAR ref. - DX RH</p> <p>806.90361 Relativo kit staffe 1006.90362 - SX LH</p> <p>Relativo kit staffe 1006.90361</p>
<p>AD ESAURIMENTO SCORTE UNTIL SELLS-OUT</p> 	<p>CARENATURA SENZA STAFFE PASSO 3800 - EURO 5 FAIRING WITHOUT BRACKET WHEEL BASE 3800 - EURO 5</p> <p>COS.PEL. ref. 806.90382 SIMILAR ref. 41272198 DX RH</p> <p>Relativo kit staffe 1006.90382</p>

Nuovo Stralis 2007 AS

	<p>DEFLETTORE LATERALE SUPERIORE S.M.C. - Euro 5/6 LATERAL DEFLECTOR S.M.C. - Euro 5/6 COS.PEL. ref. SIMILAR ref. 806.92302 5801592119 DX RH</p> <p>806.92301 Solo ricambistica, kit staffe non fornito 5801592114 SX LH Solo ricambistica, kit staffe non fornito</p>
	<p>DEFLETTORE LATERALE INFERIORE S.M.C. - Euro 5/6 LATERAL DEFLECTOR S.M.C. - Euro 5/6 COS.PEL. ref. SIMILAR ref. 806.92304 5801672866 DX RH</p> <p>Solo ricambistica, kit staffe non fornito</p>
 <p>806.92308 806.92309</p>	<p>DEFLETTORE LATERALE INFERIORE SX LATERAL DEFLECTOR LH COS.PEL. ref. SIMILAR ref. 806.92308 5801735386</p> <p>806.92309 Solo ricambistica, kit staffe non fornito 5801735398 Solo ricambistica, kit staffe non fornito</p>
	<p>CERNIERA CALANDRA ANTERIORE P.P.G.F. BRACKET P.P.G.F. COS.PEL. ref. SIMILAR ref. 1006.70604 500368694 / 504306106</p>
	<p>GRIGLIA PEDANA PLASTICA FOOTSTEP GRILLE PLASTIC COS.PEL. ref. SIMILAR ref. 1006.80540 504211437 DX RH</p> <p>1006.80541 Relativa pedana: 206.80540 / 206.90096 / 206.90098 504211438 SX LH Relativa pedana: 206.80541 / 206.90097 / 206.90099</p>
	<p>SUPPORTO PARAURTI METALLO SUPPORT BRACKET STEEL COS.PEL. ref. SIMILAR ref. 1006.90100 504022657 DX RH</p> <p>1006.90101 504022658 SX LH</p>
	<p>SUPPORTO PARAFANGO POST. PARTE POST. METALLO REAR SUPPORT MUDGUARDE REAR SIDE STEEL COS.PEL. ref. SIMILAR ref. 1006.90102 41213731 DX RH</p> <p>1006.90103 41213729 SX LH</p>
	<p>SUPPORTO PARAFANGO POST. PARTE ANT. METALLO REAR SUPPORT MUDGUARD FRONT SIDE STEEL COS.PEL. ref. SIMILAR ref. 1006.90104 41213727 DX RH</p> <p>1006.90105 41213725 SX LH</p>

	<p>COPRI BATTERIA P.P. BATTERY COVER P.P.</p> <p>COS.PEL. ref. SIMILAR ref. 1006.90106 98474429</p>
	<p>SUPPORTO MOLLA GAS P.P.G.F. GAS SPRING SUPPORT P.P.G.F.</p> <p>COS.PEL. ref. SIMILAR ref. 1006.90108 500396838</p>
	<p>BOTTONE PEDANA PARAURTI FRONT BUMPER CLIP</p> <p>COS.PEL. ref. SIMILAR ref. 1006.90110 504194581</p>
	<p>DOPPIA VITE M6 SCREW M6</p> <p>COS.PEL. ref. SIMILAR ref. 1006.90187 504171187</p>
	<p>DOPPIA VITE M8 SCREW M8</p> <p>COS.PEL. ref. SIMILAR ref. 1006.90483 504173483</p>
	<p>MOLLETTA CLIP</p> <p>COS.PEL. ref. SIMILAR ref. 1006.90487 504173487</p>
	<p>PORTALAMPADA LAMP BULB HOLDER</p> <p>COS.PEL. ref. SIMILAR ref. 002987 -</p> <p>Per lampada / For lamp : 002988</p>
	<p></p> <p>FANALINO LATERALE W5W SIDE LAMP W5W</p> <p>COS.PEL. ref. SIMILAR ref. 002988 41200664</p> <p>DX-SX RH-LH</p> <p>Relativo portalampada 002987</p>

Nuovo Stralis 2007 AS

 	<p>FANALINO VISIERA 03 -> SUN VISOR' MARKER 03 -></p> <p>COS.PEL. ref. SIMILAR ref. 1606.80046 504047265</p> <p>1606.80047 504047264</p> <p style="text-align: right;">DX RH</p> <p style="text-align: right;">SX LH</p>
 	<p>FANALINO LATERALE 3 FORI - GRIGIO SIDE LAMP 3 HOLES - GREY</p> <p>COS.PEL. ref. SIMILAR ref. 1606.90602 41221039 GRIGIO / 504250984 NERO</p> <p>1606.90603 41221029 GRIGIO / 504250958 NERO</p> <p>Relativo portalampada 1606.92811 - 003123 Relativo portalampada 1606.92811 - 003123</p> <p style="text-align: right;">DX RH</p> <p style="text-align: right;">SX LH</p>
 	<p>FANALINO ANTERIORE FRONT CORNER LAMP</p> <p>COS.PEL. ref. SIMILAR ref. 1606.90604 42555041 / 5801755123</p> <p>1606.90605 42555042 / 5801755132</p> <p>Relativo portalampada 1606.92810 Relativo portalampada 1606.92810</p> <p style="text-align: right;">DX RH</p> <p style="text-align: right;">SX LH</p>
	<p>PORTALAMPADA LAMP BULB HOLDER</p> <p>COS.PEL. ref. SIMILAR ref. 1606.92810 -</p> <p>Per / For : 1606.92802/3 - 1606.90604/5 - 1604.10604/5</p>
	<p>PORTALAMPADA LAMP BULB HOLDER</p> <p>COS.PEL. ref. SIMILAR ref. 1606.92811 -</p> <p>Per lampada / For lamp : 1606.90602/3</p>
 	<p>PROIETTORE H7 H7 - 08-> - CORRETTORE ASSETTO MANUALE HEADLAMP H7 H7 - 08-> - MANUAL LOAD LEVEL ADJUSTMENT</p> <p>COS.PEL. ref. SIMILAR ref. 1606.90600 504238093</p> <p>1606.90601 504238117</p> <p style="text-align: right;">DX RH</p> <p style="text-align: right;">SX LH</p>
 	<p>PROIETTORE FENDINEBBIA ESTERNO H1 - 08 -> OUTSIDE FOG LAMP H1 - 08 -></p> <p>COS.PEL. ref. SIMILAR ref. 1606.90606 504181095</p> <p style="text-align: right;">DX-SX RH-LH</p>
 	<p>PROIETTORE PROFONDITA' INTERNO H1 - 08 -> INNER LAMP H1 - 08 -></p> <p>COS.PEL. ref. SIMILAR ref. 1606.90607 504181096</p> <p style="text-align: right;">DX-SX RH-LH</p>

Nuovo Stralis 2007 AS

	<p>SERRATURA PORTA ELETTRICA ELECTRIC DOOR LOCK</p> <p>COS.PEL. ref. SIMILAR ref. 1706.60906 98411951 / 98416419</p> <p>1706.60905 98411952 / 98416424</p> <p style="text-align: right;">DX RH SX LH</p>
	<p>ARRESTO PORTA DOOR STOP</p> <p>COS.PEL. ref. SIMILAR ref. 1706.60908 5802132946 / 99476267</p> <p>1706.60907 5802132944 / 99476268</p> <p style="text-align: right;">DX RH SX LH</p>
	<p>GUIDA VETRO WINDOW FRAME</p> <p>COS.PEL. ref. SIMILAR ref. 1806.60134 98484152</p> <p>1806.60133 98404902</p> <p style="text-align: right;">DX RH SX LH</p>
	<p>ALZACRISTALLI ELETTRICO - CON MOTORINO - 2 PIN WINDOW REGULATOR ELECTRIC - WITH MOTOR - 2 PIN</p> <p>COS.PEL. ref. SIMILAR ref. 1906.60032 2997195 / 98407721 / 99487780</p> <p>1906.60033 2997196 / 98407722 / 99487781</p> <p style="text-align: right;">DX RH SX LH</p>
	<p>ALZACRISTALLI ELETTRICO - CON MOTORINO - 2 PIN WINDOW REGULATOR ELECTRIC - WITH MOTOR - 2 PIN</p> <p>COS.PEL. ref. SIMILAR ref. 1906.90030 50404988 / 504157968 / 5801324907</p> <p>1906.90031 50404989 / 504157969 / 5801324893</p> <p style="text-align: right;">DX RH SX LH</p>
<p>AD ESAURIMENTO SCORTE UNTIL SELLS-OUT</p> 	<p>VASCHETTA ESPANSIONE EXPANSION TANK</p> <p>COS.PEL. ref. SIMILAR ref. 2106.80080 41215631</p>
	<p>TIRANTE COPRI BATTERIA CORTO 140 mm MUDGUARD TENSIONER SHORT 140 mm</p> <p>COS.PEL. ref. SIMILAR ref. 1006.90107 4605163</p>
	<p>TIRANTE COPRI BATTERIA LUNGO 144 mm MUDGUARD TENSIONER LONG 144 mm</p> <p>COS.PEL. ref. SIMILAR ref. 1006.90109 4784894</p>

COS.IVE

Nuovo Stralis 2007 AS

	<p>KIT PER CONNESSIONI ELETTRICHE Connettore HDSCS singolo KIT FOR ELECTRICAL JOINTS Connector HDSCS simple</p> <p>COS.PEL. ref. SIMILAR ref. 003119 -</p>
	<p>KIT PER CONNESSIONI ELETTRICHE Connettore SUPERSEAL 2 vie femmina KIT FOR ELECTRICAL JOINTS Connector SUPERSEAL ways female</p> <p>COS.PEL. ref. SIMILAR ref. 003123 -</p> <p>Connettore per la serie 1500.xxxxx</p>
 <p style="text-align: center;">15,2 cm</p>	<p>FANALE POSTERIORE REAR-LIGHT LED - 24V - CONNETTORE POSTERIORE AMP 1.5 LED - 24V - REAR CONNECTOR AMP 1.5</p> <p>COS.PEL. ref. SIMILAR ref. 1500.00000 -</p> <p>1500.00001 -</p> <p>TRASPARENTE / LENS</p> <p style="text-align: right;">DX RH SX LH</p> <p>Relativo connettore multipolare 003120 Relativo connettore multipolare 003120</p>
 <p style="text-align: center;">cm 15,1</p>	<p>FANALE POSTERIORE REAR-LIGHT LED - 24V - CONNETTORE LATERALE HDSCS LED - 24V - LATERAL CONNECTOR HDSCS</p> <p>COS.PEL. ref. SIMILAR ref. 1506.92000 5802000573</p> <p>1506.92001 5802062689</p> <p>TRASPARENTE / LENS</p> <p style="text-align: right;">DX RH SX LH</p> <p>Relativo connettore 003119 Relativo connettore 003119</p> <p>1503.45100 - DX RH 1503.45101 - SX LH</p>
 <p style="text-align: center;">cm 15,1</p>	<p>FANALE POSTERIORE REAR-LIGHT LED - 24V - CONNETTORE LATERALE HDSCS LED - 24V - LATERAL CONNECTOR HDSCS</p> <p>COS.PEL. ref. SIMILAR ref. 1506.92002 5802000767</p> <p>1506.92003 5802000568</p> <p>TRASPARENTE / LENS</p> <p style="text-align: right;">DX RH SX LH</p> <p>Con cicalino / With buzzer - Relativo connettore 003119 Con luce targa / With plate light - Relativo connettore 003119</p> <p>1503.45100 - DX RH 1503.45101 - SX LH</p>
 <p style="text-align: center;">cm 15,1</p>	<p>FANALE POSTERIORE REAR-LIGHT LED - 24V - CONNETTORE POSTERIORE HDSCS LED - 24V - REAR CONNECTOR HDSCS</p> <p>COS.PEL. ref. SIMILAR ref. 1506.92004 5802000770</p> <p>1506.92005 5802000570</p> <p>TRASPARENTE / LENS</p> <p style="text-align: right;">DX RH SX LH</p> <p>Relativo connettore 003119 Relativo connettore 003119</p> <p>1503.45100 - DX RH 1503.45101 - SX LH</p>
 <p style="text-align: center;">cm 15,1</p>	<p>FANALE POSTERIORE REAR-LIGHT LED - 24V - CONNETTORE POSTERIORE HDSCS LED - 24V - REAR CONNECTOR HDSCS</p> <p>COS.PEL. ref. SIMILAR ref. 1506.92006 5802000772</p> <p>1506.92007 5802055273</p> <p>TRASPARENTE / LENS</p> <p style="text-align: right;">DX RH SX LH</p> <p>Con cicalino / With buzzer - Relativo connettore 003119 Con luce targa / With plate light - Relativo connettore 003119</p> <p>1503.45100 - DX RH 1503.45101 - SX LH</p>

Stralis Trakker HI-WAY



	<p>GRIGLIA GRILLE</p> <p>COS.PEL. ref. 106.93150 SIMILAR ref. 5801550647</p> <p>Relativa cerniera 1006.70604</p>
	<p>RIPAROFANGO P.P. - NERO REAR MUDGUARD P.P. - BLACK</p> <p>COS.PEL. ref. 206.93200 SIMILAR ref. -</p> <p>206.93201 -</p> <p style="text-align: right;">DX RH</p> <p style="text-align: right;">SX LH</p>
	<p>PARAFANGO PEDANA NERA S.M.C. - SENZA ALETTA FOOTSTEP MUDGUARD BLACK S.M.C. - W/O FLAP</p> <p>COS.PEL. ref. 206.93202 SIMILAR ref. 504211275</p> <p>206.93203 504211274</p> <p style="text-align: right;">DX RH</p> <p style="text-align: right;">SX LH</p>
	<p>PEDANA P.P.G.F. - NERO FOOTSTEP P.P.G.F. - BLACK</p> <p>COS.PEL. ref. 306.78190 SIMILAR ref. 2997737 / 504161152</p> <p>306.78191 2997736 / 504161151</p> <p style="text-align: right;">DX RH</p> <p style="text-align: right;">SX LH</p>
	<p>PEDANA P.P.G.F. - NERO FOOTSTEP P.P.G.F. - BLACK</p> <p>COS.PEL. ref. 306.78192 SIMILAR ref. 2997735 / 504161150</p> <p>306.78193 2997734 / 504161149</p> <p style="text-align: right;">DX RH</p> <p style="text-align: right;">SX LH</p>

ALL ITEMS MENTIONED IN OUR CATALOGUE ARE NOT ORIGINAL PARTS BUT PERFECTLY INTERCHANGEABLE WITH THEM.

GOVERNING LEGISLATIONS FOR THE SALE OF OUR PRODUCTS DIFFER IN EACH COUNTRY.

INFRINGEMENTS, IF ANY, OF LOCAL LEGISLATIONS ARE RESPONSIBILITY OF THE RETAILER IN THE COUNTRY OF FINAL DISTRIBUTION.



Stralis Trakker HI-WAY

	<p>PEDANA P.P.G.F. - NERO FOOTSTEP P.P.G.F. - BLACK COS.PEL. ref. 306.78194</p> <p>SIMILAR ref. 2997733 / 504103237</p> <p>306.78195 2997732 / 504103236</p> <p style="text-align: right;">DX RH SX LH</p>
	<p>PEDANA P.P.G.F. - NERO FOOTSTEP P.P.G.F. - BLACK COS.PEL. ref. 306.78196</p> <p>SIMILAR ref. 2997731 / 504103235</p> <p>306.78197 2997730 / 504103234</p> <p style="text-align: right;">DX RH SX LH</p>
	<p>KIT PEDANA FOOTSTEP KIT</p> <p>COS.PEL. ref. 306.78202</p> <p>SIMILAR ref. 504097984 / 504097996 / 504102899 / 504102900 306.78200 + 306.78201 + 1006.78996 (x 2)</p>
	<p>PEDANA P.P.G.F. - GRIGIO FOOTSTEP P.P.G.F. - GREY COS.PEL. ref. 306.78198</p> <p>SIMILAR ref. 2997524 / 504103233 / 504218912</p> <p>306.78199 2997523 / 504103232 / 504218911</p> <p style="text-align: right;">DX RH SX LH</p>
	<p>PEDANA P.P.G.F. - NERO FOOTSTEP P.P.G.F. - BLACK COS.PEL. ref. 306.78204</p> <p>SIMILAR ref. 504053093</p> <p>306.78203 5040053092</p> <p style="text-align: right;">DX RH SX LH</p>
	<p>PARAURTI CENTRALE METALLO CENTRAL BUMPER METAL COS.PEL. ref. 406.79090</p> <p>SIMILAR ref. 504221272</p>
	<p>ANGOLO PARAURTI METALLO CORNER BUMPER METAL COS.PEL. ref. 406.79092</p> <p>SIMILAR ref. 504221320</p> <p>406.79091 504221321</p> <p style="text-align: right;">DX RH SX LH</p>
	<p>SPECCHIO RETROVISORE ELETTRICO - RISCALDATO - BRACCIO MEDIO REAR-VIEW MIRROR ELECTRIC - HEATED - MEDIUM ARM COS.PEL. ref. 506.90098</p> <p>SIMILAR ref. 504370055 / 5801336298 / 5801580230</p> <p>506.90099 504370048 / 5801336285</p> <p style="text-align: right;">DX RH SX LH</p>

Stralis Trakker HI-WAY

	<p>CONVOGLIATORE ARIA A.B.S. AIR CONVEYOR A.B.S. COS.PEL. ref. SIMILAR ref. 906.93180 5801564804 DX RH</p> <p>906.93181 5801564805 SX LH</p>
	<p>COPRI BATTERIA P.P. BATTERY COVER P.P. COS.PEL. ref. SIMILAR ref. 1006.90106 98474429</p>
 	<p>FANALINO LATERALE 4 LED SIDE LAMP 4 LED COS.PEL. ref. SIMILAR ref. 002986 5801631615 DX-SX RH-LH</p>
	<p>PORTALAMPADA LAMP BULB HOLDER COS.PEL. ref. SIMILAR ref. 002987 - Per lampada / For lamp : 002988</p>
 	<p>FANALINO LATERALE W5W SIDE LAMP W5W COS.PEL. ref. SIMILAR ref. 002988 41200664 DX-SX RH-LH Relativo portalampada 002987</p>
 	<p>FANALINO CORNER LAMP COS.PEL. ref. SIMILAR ref. 1606.80040 41221040 / 42555022 DX RH</p> <p>1606.80041 41221041 / 42555023 SX LH</p>
 	<p>FANALINO LATERALE 2 FORI - GRIGIO CORNER LAMP 2 HOLES - GREY COS.PEL. ref. SIMILAR ref. 1606.92814 5801629858 / 5801754888 DX RH</p> <p>1606.92813 Relativo portalampada : 5801629859 / 5801754889 SX LH Relativo portalampada :</p>
 	<p>PROIETTORE H7 H7 - 08-> - CORRETTORE ASSETTO MANUALE HEADLAMP H7 H7 - 08-> - MANUAL LOAD LEVEL ADJUSTEMENT COS.PEL. ref. SIMILAR ref. 1606.90600 504238093 DX RH</p> <p>1606.90601 504238117 SX LH</p>

Stralis Trakker HI-WAY

	<p>ALZACRISTALLI ELETTRICO - CON MOTORINO - 2 PIN WINDOW REGULATOR ELECTRIC - WITH MOTOR - 2 PIN COS.PEL. ref. SIMILAR ref. 1906.60032 2997195 / 98407721 / 99487780 1906.60033 2997196 / 98407722 / 99487781</p> <p>DX RH SX LH</p>
	<p>ALZACRISTALLI ELETTRICO - CON MOTORINO - 2 PIN WINDOW REGULATOR ELECTRIC - WITH MOTOR - 2 PIN COS.PEL. ref. SIMILAR ref. 1906.90030 504040988 / 504157968 / 5801324907 1906.90031 504040989 / 504157969 / 5801324893</p> <p>DX RH SX LH</p>
	<p>TIRANTE COPRI BATTERIA CORTO 140 mm MUDGUARD TENSIONER SHORT 140 mm COS.PEL. ref. SIMILAR ref. 1006.90107 4605163</p>
	<p>TIRANTE COPRI BATTERIA LUNGO 144 mm MUDGUARD TENSIONER LONG 144 mm COS.PEL. ref. SIMILAR ref. 1006.90109 4784894</p>

Stralis 2013 HI-WAY - AD/AT



	<p>GRIGLIA DI PROTEZIONE GRILLE</p> <p>COS.PEL. ref. 106.92101 SIMILAR ref. 5801549092</p>
	<p>GRIGLIA GRILLE</p> <p>COS.PEL. ref. 106.93150 SIMILAR ref. 5801550647</p> <p>Relativa cerniera 1006.70604</p>
	<p>PARAFANGO PEDANA NERA CON ALETTA SENZA FORI FOOTSTEP MUDGUARD BLACK</p> <p>COS.PEL. ref. 206.93204 SIMILAR ref. -</p> <p>206.93205 -</p> <p style="text-align: right;">DX RH SX LH</p>
	<p>CALOTTA POST. RIBAS. NERA CON 4 TIRANTI P.P. - NERO REAR MUDGUARD WITH 4 MUDGUARD TENSIONERS P.P. - BLACK</p> <p>COS.PEL. ref. 206.90196 SIMILAR ref. 2997670 / 41298976 DX-SX RH-LH</p> <p>(206.90199 versione senza i tiranti)</p>
	<p>CALOTTA POSTERIORE RIBASSATA P.P. - NERO REAR MUDGUARD P.P. - BLACK</p> <p>COS.PEL. ref. 206.90199 SIMILAR ref. 41298976 DX-SX RH-LH</p> <p>Relativo tirante 1006.80696 - (206.90196 versione con i tiranti)</p>

ALL ITEMS MENTIONED IN OUR CATALOGUE ARE NOT ORIGINAL PARTS BUT PERFECTLY INTERCHANGEABLE WITH THEM.

GOVERNING LEGISLATIONS FOR THE SALE OF OUR PRODUCTS DIFFER IN EACH COUNTRY.

INFRINGEMENTS, IF ANY, OF LOCAL LEGISLATIONS ARE RESPONSIBILITY OF THE RETAILER IN THE COUNTRY OF FINAL DISTRIBUTION.



Stralis 2013 HI-WAY - AD/AT

	<p>CALOTTA POSTERIORE P.P. - NERO REAR MUDGUARD P.P. - BLACK</p> <p>COS.PEL. ref. 206.90200 SIMILAR ref. 41298975</p> <p style="text-align: right;">DX-SX RH-LH</p> <p style="text-align: right;">Relativo tirante 1006.80696 - (206.90208 versione con i tiranti)</p>
	<p>MEZZO PARAFANGO POSTERIORE P.P. - PARTE ANTERIORE - NERO - STAFFA INTERNA LUNGA MUDGUARD P.P. - FRONT SIDE - BLACK - INTERNAL BRACKET LONG</p> <p>COS.PEL. ref. 206.90201 SIMILAR ref. 41298962</p> <p style="text-align: right;">DX-SX RH-LH</p> <p style="text-align: right;">Kit : 1006.880751</p>
	<p>MEZZO PARAFANGO POSTERIORE P.P. - PARTE POSTERIORE - NERO - STAFFA INTERNA CORTA MUDGUARD P.P. - REAR SIDE - BLACK - INTERNAL BRACKET SHORT</p> <p>COS.PEL. ref. 206.90202 SIMILAR ref. 41298964</p> <p style="text-align: right;">DX-SX RH-LH</p> <p style="text-align: right;">Kit : 1006.80752</p>
	<p>COPERCHIO PARAFANGO POSTERIORE P.P. - PARTE POSTERIORE - NERO - CON STAFFA COVER REAR MUDGUARD P.P. - REAR SIDE - BLACK - WITH BRACKET</p> <p>COS.PEL. ref. 206.90204 SIMILAR ref. 41298974</p> <p style="text-align: right;">DX RH</p> <p>206.90203 41298973 SX LH</p>
	<p>COPERCHIO PARAFANGO POSTERIORE P.P. - ANTERIORE - NERO COVER REAR MUDGUARD P.P. - FRONT - BLACK</p> <p>COS.PEL. ref. 206.90206 SIMILAR ref. 41298888</p> <p style="text-align: right;">DX RH</p> <p>206.90205 41298887 SX LH</p>
	<p>MEZZO PARAFANGO POSTERIORE SENZA STAFFE P.P. - PARTE ANTERIORE - NERO - SENZA STAFFE COVER REAR MUDGUARD W/O BRACKETS P.P. - FRONT SIDE - BLACK - WITHOUT BRACKETS</p> <p>COS.PEL. ref. 206.90207 SIMILAR ref. -</p> <p style="text-align: right;">DX-SX RH-LH</p> <p style="text-align: right;">Senza staffe</p>
	<p>CALOTTA POSTERIORE CON 4 TIRANTI P.P. - NERO REAR MUDGUARD WITH 4 M. TENSIONERS P.P. - BLACK</p> <p>COS.PEL. ref. 206.90208 SIMILAR ref. 2997670 / 41213696 / 41298975</p> <p style="text-align: right;">DX-SX RH-LH</p> <p style="text-align: right;">(206.90200 versione senza i tiranti)</p>
	<p>CALOTTA POSTERIORE P.P. - NERO REAR MUDGUARD P.P. - BLACK</p> <p>COS.PEL. ref. 206.92100 SIMILAR ref. 41289079</p> <p style="text-align: right;">DX-SX RH-LH</p> <p style="text-align: right;">Relativo tirante 1006.80696 - (206.92107 versione con i tiranti)</p>









Stralis 2013 HI-WAY - AD/AT

	<p>MEZZO PARAFANGO POSTERIORE PARTE ANT. P.P. - NERO REAR MUDGUARD FRONT SIZE P.P. - BLACK COS.PEL. ref. SIMILAR ref.</p> <p>206.92102 41288786 / 41289082 / 5801698294 DX RH</p> <p>206.92101 41288784 / 41289081 / 5801698293 SX LH</p>
	<p>MEZZO PARAFANGO POSTERIORE PARTE POST. P.P. - NERO REAR MUDGUARD REAR SIDE P.P. - BLACK COS.PEL. ref. SIMILAR ref.</p> <p>206.92104 41288785 / 41289088 DX RH</p> <p>206.92103 41288783 / 41289087 SX LH</p>
	<p>SUPPORTO FARO POSTERIORE P.P. - NERO LENS BRACKET P.P. - BLACK COS.PEL. ref. SIMILAR ref.</p> <p>206.92106 41288777 DX RH</p> <p>206.92105 41288776 SX LH</p>
	<p>CALOTTA PARAFANGO POSTERIORE CON 4 TIRANTI P.P. - NERO REAR MUDGUARD WITH 4 M. TENSIONERS P.P. - BLACK COS.PEL. ref. SIMILAR ref.</p> <p>206.92107 2997670 / 41213696 / 41289079 DX-SX RH-LH (206.92100 versione senza i tiranti)</p>
	<p>PEDANA CON FORI MODANATURA P.P.G.F. - NERO FOOTSTEP WITH HOLES P.P.G.F. - BLACK COS.PEL. ref. SIMILAR ref.</p> <p>306.80012 2997739 / 504136556 / 504368383 DX RH</p> <p>306.80013 2997738 / 504136555 / 504368379 SX LH</p>
	<p>PEDANA SENZA FORI P.P.G.F. - NERA FOOTSTEP W/O HOLES P.P.G.F. - BLACK COS.PEL. ref. SIMILAR ref.</p> <p>306.80022 504368373 DX RH</p> <p>306.80023 504368376 SX LH</p>
	<p>PEDANA P.P.G.F. - BIANCO SMALTATO FOOTSTEP P.P.G.F. - WHITE ENAMELLED COS.PEL. ref. SIMILAR ref.</p> <p>306.80026 2997119 / 500375431 DX RH</p> <p>306.80027 306.80030 : ROSSO MARANELLO 2997119 / 500375431 SX LH 306.80031 : ROSSO MARANELLO</p>
	<p>PARAURTI ANTERIORE P.P.T./P.P.G.F. - BIANCO SMALTATO FRONT BUMPER P.P.T./P.P.G.F. - WHITE ENAMELLED COS.PEL. ref. SIMILAR ref.</p> <p>406.90080 504186932 / 504284316 / 5801603586 406.90078 : ROSSO MARANELLO 406.90077 : NERO OPACO</p>

Stralis 2013 HI-WAY - AD/AT

	<p>PARAURTI ANTERIORE P.P.T./P.P.G.F. - NERO (NON VERNICIATO) FRONT BUMPER P.P.T./P.P.G.F. - BLACK (NO PAINTED)</p> <p>COS.PEL. ref. SIMILAR ref. 406.90086 504186932 / 504284316</p>
	<p>PARAURTI ANTERIORE P.P.T./P.P.G.F. - PRIMER FRONT BUMPER P.P.T./P.P.G.F. - PRIMER</p> <p>COS.PEL. ref. SIMILAR ref. 406.90091 504186932 / 504284316 / 5801603586</p>
	<p>ANGOLO SOTTOPARAURTI P.P. - NERO CORNER BUMPER P.P. - BLACK</p> <p>COS.PEL. ref. SIMILAR ref. 406.92070 5801562167 DX RH</p> <p>406.92071 5801562166 SX LH</p>
	<p>SOTTOPARAURTI CENTRALE P.P. - NERO CENTRAL BUMPER P.P. - BLACK</p> <p>COS.PEL. ref. SIMILAR ref. 406.92072 5801562137</p>
	<p>TAPPO TELECAMERA PER PARAURTI COVER BUMPER</p> <p>COS.PEL. ref. SIMILAR ref. 406.92077 5801974516</p>
	<p>PARAURTI ANTERIORE CON RADAR P.P.T./P.P.G.F. - CON FORO RADAR - BIANCO SMALTATO FRONT BUMPER P.P.T./P.P.G.F. - WITH RADAR HOLE - WHITE ENAMELLED</p> <p>COS.PEL. ref. SIMILAR ref. 406.93081 5802055591 / 5802066514</p> <p>406.93078 : ROSSO MARANELLO 406.93077 : NERO OPACO</p>
	<p>PARAURTI ANTERIORE P.P.T./P.P.G.F. - CON FORO RADAR - NERO (NON VERNICIATO) FRONT BUMPER P.P.T./P.P.G.F. - WITH RADAR HOLE - BLACK (NO PAINTED)</p> <p>COS.PEL. ref. SIMILAR ref. 406.93086 5802055591 / 5802066514</p>
	<p>PARAURTI ANTERIORE CON RADAR CON FORO RADAR - PRIMER FRONT BUMPER WITH RADAR HOLE - PRIMER</p> <p>COS.PEL. ref. SIMILAR ref. 406.93091 5802055591 / 5802066514</p>









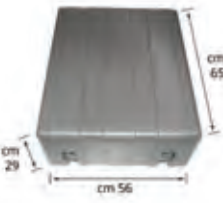

Stralis 2013 HI-WAY - AD/AT

	<p>SPORTELLLO CENTRALE PARAURTI A.B.S. - NERO CENTRAL COVER BUMPER A.B.S. - BLACK</p> <p>COS.PEL. ref. SIMILAR ref. 406.90092 504187294</p>
	<p>TAPPO PARAURTI P.P. - NERO BUMPER COVER P.P. - BLACK</p> <p>COS.PEL. ref. SIMILAR ref. 406.90093 504187339</p>
	<p>SPORTELLLO SUPERIORE PARAURTI P.P. - NERO UPPER BUMPER COVER P.P. - BLACK</p> <p>COS.PEL. ref. SIMILAR ref. 406.90094 504187426 DX RH</p> <p>406.90095 504187427 SX LH</p>
	<p>SPORTELLLO LATERALE PARAURTI P.P. - NERO SIDE BUMPER COVER P.P. - BLACK</p> <p>COS.PEL. ref. SIMILAR ref. 406.90096 504187506 DX RH</p> <p>406.90097 504187507 SX LH</p>
	<p>SUPPORTO FENDI INTERNO P.P.G.F. - NERO FOG LAMP BRACKET P.P.G.F. - BLACK</p> <p>COS.PEL. ref. SIMILAR ref. 406.90098 504173478 DX RH</p> <p>406.90099 504173477 SX LH</p>
	<p>CORNICE FENDINEBBIA P.P. - PRIMER FOG LAMP FRAME P.P. - PRIMER</p> <p>COS.PEL. ref. SIMILAR ref. 406.90100 504188129 DX RH</p> <p>406.90101 504188130 SX LH</p>
	<p>PEDANA PARAURTI P.P. - NERO UPPER BUMPER FOOTSTEP P.P. - BLACK</p> <p>COS.PEL. ref. SIMILAR ref. 406.90102 500380111 / 504032325 / 504194669</p>
	<p>PEDANA PARAURTI P.P. - NERO UPPER BUMPER FOOTSTEP P.P. - BLACK</p> <p>COS.PEL. ref. SIMILAR ref. 406.90103 504135514</p>

Stralis 2013 HI-WAY - AD/AT

	<p>SPOILER TETTO FISSO S.M.C. SPOILER S.M.C.</p> <p>COS.PEL. ref. 606.93600 SIMILAR ref. 5801698782</p>
	<p>SPOILER TETTO MOBILE S.M.C. SPOILER S.M.C.</p> <p>COS.PEL. ref. 606.93601 SIMILAR ref. 5801698762</p>
	<p>VISIERA SUN VISOR</p> <p>COS.PEL. ref. 706.93200 SIMILAR ref. 5801715566</p> <p>Relativo kit staffe 1006.93200</p>
	<p>DEFLETTORE LATERALE SUPERIORE S.M.C. LATERAL DEFLECTOR S.M.C.</p> <p>COS.PEL. ref. 806.93602 SIMILAR ref. 5801698798 DX RH</p> <p>806.93603 5801698838 SX LH</p>
	<p>DEFLETTORE LATERALE INFERIORE S.M.C. LATERAL DEFLECTOR S.M.C.</p> <p>COS.PEL. ref. 806.93604 SIMILAR ref. 5801698793 DX RH</p> <p>806.93605 5801698846 SX LH</p>
	<p>CONVOGLIATORE ARIA A.B.S. AIR CONVEYOR A.B.S.</p> <p>COS.PEL. ref. 906.93180 SIMILAR ref. 5801564804 DX RH</p> <p>906.93181 5801564805 SX LH</p>
	<p>GRIGLIA PEDANA PLASTICA FOOTSTEP GRILLE PLASTIC</p> <p>COS.PEL. ref. 1006.70532 SIMILAR ref. 504242345 DX RH</p> <p>1006.70533 Relativa pedana: 206.70530 / 206.70532 / 206.93202 / 206.93204 504242346 SX LH</p> <p>Relativa pedana: 206.70531 / 206.70533 / 206.93203 / 206.93205</p>
	<p>CERNIERA CALANDRA ANTERIORE P.P.G.F. BRACKET P.P.G.F.</p> <p>COS.PEL. ref. 1006.70604 SIMILAR ref. 500368694 / 504306106</p>

Stralis 2013 HI-WAY - AD/AT

	<p>COPRI BATTERIA P.P. BATTERY COVER P.P.</p> <p>COS.PEL. ref. SIMILAR ref. 1006.90106 98474429</p>
	<p>SUPPORTO MOLLA GAS P.P.G.F. GAS SPRING SUPPORT P.P.G.F.</p> <p>COS.PEL. ref. SIMILAR ref. 1006.90108 500396838</p>
	<p>BOTTONE PEDANA PARAURTI FRONT BUMPER CLIP</p> <p>COS.PEL. ref. SIMILAR ref. 1006.90110 504194581</p>
 	<p>FANALINO LATERALE 4 LED SIDE LAMP 4 LED</p> <p>COS.PEL. ref. SIMILAR ref. 002986 5801631615</p> <p style="text-align: right;">DX-SX RH-LH</p>
	<p>PORTALAMPADA LAMP BULB HOLDER</p> <p>COS.PEL. ref. SIMILAR ref. 002987 -</p> <p style="text-align: right;">Per lampada / For lamp : 002988</p>
 	<p>FANALINO LATERALE W5W SIDE LAMP W5W</p> <p>COS.PEL. ref. SIMILAR ref. 002988 41200664</p> <p style="text-align: right;">DX-SX RH-LH</p> <p style="text-align: right;">Relativo portalampada 002987</p>
 	<p>FANALINO ANTERIORE DX FRONT LAMP</p> <p>COS.PEL. ref. SIMILAR ref. 1606.92802 5801572018 / 5801755107 DX RH</p> <p style="text-align: right;">Relativo portalampada 1606.92810</p> <p>1606.92803 5801572024 / 5801755108 SX LH</p> <p style="text-align: right;">Relativo portalampada 1606.92810</p>
	<p>FANALINO VISIERA SUN VISOR'S MARKER</p> <p>COS.PEL. ref. SIMILAR ref. 1606.92804 5801546522 DX RH</p> <p>1606.92805 5801546548 SX LH</p>

Stralis 2013 HI-WAY - AD/AT

 	<p>FANALINO LATERALE 3 FORI SIDE LAMP 3 HOLES COS.PEL. ref. SIMILAR ref. 1606.92806 5801572074 / 5801754885 DX RH</p> <p>1606.92807 5801572080 / 5801754886 SX LH</p>
	<p>PROIETTORE CON CENTRALINA XENON - D1S - LED - CON CENTRALINA HEADLAMP WITH CONTROL UNIT XENON - D1S - LED - WITH CONTROL UNIT COS.PEL. ref. SIMILAR ref. 1606.92798 5801745442 DX RH</p> <p>1606.92799 Relativa centralina 1606.92812 5801745441 SX LH Relativa centralina 1606.92812</p>
 	<p>PROIETTORE CORRETTORE ASSETTO MANUALE - CON CENTRALINA FRONT LAMP MANUAL LOAD LEVEL ADJUSTEMENT - WITH CONTROL UNIT COS.PEL. ref. SIMILAR ref. 1606.92800 5801745452 DX RH</p> <p>1606.92801 Relativa centralina 1606.92812 5801745449 SX LH Relativa centralina 1606.92812</p>
 	<p>PROIETTORE CORRETTORE ASSETTO MANUALE SENZA CENTRALINA HEADLAMP MANUAL LOAD LEVEL ADJUSTEMENT WITHOUT ELECTRONIC CONTROL UNIT COS.PEL. ref. SIMILAR ref. 1606.92808 - DX RH</p> <p>1606.92809 - SX LH</p>
	<p>SERRATURA PORTA ELETTRICA ELECTRIC DOOR LOCK COS.PEL. ref. SIMILAR ref. 1706.60906 98411951 / 98416419 DX RH</p> <p>1706.60905 98411952 / 98416424 SX LH</p>
	<p>ARRESTO PORTA DOOR STOP COS.PEL. ref. SIMILAR ref. 1706.60908 5802132946 / 99476267 DX RH</p> <p>1706.60907 5802132944 / 99476268 SX LH</p>
	<p>GUIDA VETRO WINDOW FRAME COS.PEL. ref. SIMILAR ref. 1806.60134 98484152 DX RH</p> <p>1806.60133 98404902 SX LH</p>
	<p>ALZACRISTALLI ELETTRICO - CON MOTORINO - 2 PIN WINDOW REGULATOR ELECTRIC - WITH MOTOR - 2 PIN COS.PEL. ref. SIMILAR ref. 1906.60032 2997195 / 98407721 / DX RH 99487780</p> <p>1906.60033 2997196 / 98407722 / SX LH 99487781</p>

Stralis 2013 HI-WAY - AD/AT

	<p>ALZACRISTALLI ELETTRICO - CON MOTORINO - 2 PIN WINDOW REGULATOR ELECTRIC - WITH MOTOR - 2 PIN COS.PEL. ref. SIMILAR ref. 1906.90030 504040988 / 504157968 / 5801324907 DX RH 1906.90031 504040989 / 504157969 / 5801324893 SX LH</p>
	<p>TIRANTE COPRI BATTERIA CORTO 140 mm MUDGUARD TENSIONER SHORT 140 mm COS.PEL. ref. SIMILAR ref. 1006.90107 4605163</p>
	<p>TIRANTE COPRI BATTERIA LUNGO 144 mm MUDGUARD TENSIONER LONG 144 mm COS.PEL. ref. SIMILAR ref. 1006.90109 4784894</p>
	<p>KIT PER CONNESSIONI ELETTRICHE Connettore HDSCS singolo KIT FOR ELECTRICAL JOINTS Connector HDSCS simple COS.PEL. ref. SIMILAR ref. 003119 -</p>
	<p>FANALE POSTERIORE REAR-LIGHT Interasse tra le viti 15,3 cm Inter-axis 15,3 cm COS.PEL. ref. SIMILAR ref. 006154 5801363431 DX RH 006153 5801363428 SX LH TRASPARENTE / LENS 011110 93161844 DX-SX RH-LH</p>
	<p>FANALE POSTERIORE REAR-LIGHT Interasse tra le viti 15,3 cm Inter-axis 15,3 cm COS.PEL. ref. SIMILAR ref. 006155 5801363432 DX RH 006157 - SX LH Con Cicalino / With Buzzer TRASPARENTE / LENS Con luce targa / With plate light 011110 93161844 DX-SX RH-LH</p>
	<p>FANALE POSTERIORE REAR-LIGHT LED - 24V - CONNETTORE LATERALE HDSCS LED - 24V - LATERAL CONNECTOR HDSCS COS.PEL. ref. SIMILAR ref. 1506.92000 5802000573 DX RH 1506.92001 5802062689 SX LH Relativo connettore 003119 Relativo connettore 003119 TRASPARENTE / LENS 1503.45100 - DX RH 1503.45101 - SX LH</p>
	<p>FANALE POSTERIORE REAR-LIGHT LED - 24V - CONNETTORE LATERALE HDSCS LED - 24V - LATERAL CONNECTOR HDSCS COS.PEL. ref. SIMILAR ref. 1506.92002 5802000767 DX RH 1506.92003 5802000568 SX LH Con cicalino / With buzzer - Relativo connettore 003119 Con luce targa / With plate light - Relativo connettore 003119 TRASPARENTE / LENS 1503.45100 - DX RH 1503.45101 - SX LH</p>

Stralis 2013 HI-WAY - AD/AT

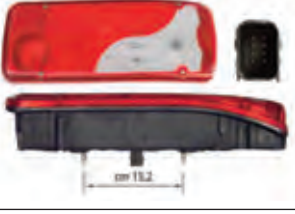
	<p>FANALE POSTERIORE REAR-LIGHT LED - 24V - CONNETTORE POSTERIORE HDSCS LED - 24V - REAR CONNECTOR HDSCS</p> <p>COS.PEL. ref. 1506.92004 SIMILAR ref. 5802000770 Relativo connettore 003119</p> <p>1506.92005 5802000570 Relativo connettore 003119</p> <p>TRASPARENTE / LENS 1503.45100 - DX RH 1503.45101 - SX LH</p>
	<p>FANALE POSTERIORE REAR-LIGHT LED - 24V - CONNETTORE POSTERIORE HDSCS LED - 24V - REAR CONNECTOR HDSCS</p> <p>COS.PEL. ref. 1506.92006 SIMILAR ref. 5802000772 Con cicalino / With buzzer - Relativo connettore 003119</p> <p>1506.92007 5802055273 Con luce targa / With plate light - Relativo connettore 003119</p> <p>TRASPARENTE / LENS 1503.45100 - DX RH 1503.45101 - SX LH</p>
	<p>FANALE POSTERIORE REAR-LIGHT 24V - CONNETTORE LATERALE HDSCS 24V - SIDE CONNECTOR HDSCS</p> <p>COS.PEL. ref. 1506.92008 SIMILAR ref. 5801637201 Relativo connettore 003119</p> <p>1506.92009 5801637199 Con luce targa / With plate light - Relativo connettore 003119</p> <p>TRASPARENTE / LENS 1506.92100 42575877 DX RH 1506.92101 42575315 SX LH</p>
	<p>FANALE POSTERIORE REAR-LIGHT 24V - CONNETTORE LATERALE HDSCS 24V - SIDE CONNECTOR HDSCS</p> <p>COS.PEL. ref. 1506.92010 SIMILAR ref. 5801637702 Con cicalino / With buzzer - Relativo connettore 003119</p> <p>TRASPARENTE / LENS 1506.92100 42575877 DX RH</p>
	<p>FANALE POSTERIORE REAR-LIGHT 24V - CONNETTORE POSTERIORE HDSCS 24V - REAR CONNECTOR HDSCS</p> <p>COS.PEL. ref. 1506.92012 SIMILAR ref. 5801757328 Relativo connettore 003119</p> <p>1506.92011 5801637182 Relativo connettore 003119</p> <p>TRASPARENTE / LENS 1506.92100 42575877 DX RH 1506.92101 42575315 SX LH</p>
	<p>FANALE POSTERIORE REAR-LIGHT 24V - CONNETTORE POSTERIORE HDSCS 24V - REAR CONNECTOR HDSCS</p> <p>COS.PEL. ref. 1506.92014 SIMILAR ref. 5801757326 Con cicalino / With buzzer - Relativo connettore 003119</p> <p>1506.92013 5802055272 Con luce targa / With plate light - Relativo connettore 003119</p> <p>TRASPARENTE / LENS 1506.92100 42575877 DX RH 1506.92101 42575315 SX LH</p>



	<p>GRIGLIA GRILLE</p> <p>COS.PEL. ref. SIMILAR ref. 106.92100 5801549064</p> <p>Relativa cerniera 1006.70604</p>
	<p>GRIGLIA DI PROTEZIONE GRILLE</p> <p>COS.PEL. ref. SIMILAR ref. 106.92101 5801549092</p>
	<p>PEDANA PARAFANGO S.M.C. - NERO - CON FORI MODANATURA + PORTAOGGETTI MUDGUARD FOOTSTEP S.M.C. - BLACK - WITH HOLES</p> <p>COS.PEL. ref. SIMILAR ref. 206.90096 504132808 / 504132811 / 5801840558 / 5801840561</p> <p>206.90097 504211219 / 5801840565</p> <p style="text-align: right;">DX RH</p> <p style="text-align: right;">SX LH</p>
	<p>PEDANA PARAFANGO S.M.C. NERO - CON FORO PORTAOGGETTI MUDGUARD FOOTSTEP S.M.C. - BLACK - WITH HOLE</p> <p>COS.PEL. ref. SIMILAR ref. 206.90098 504020073 / 504103308 / 5801840545</p> <p>206.90099 500375472 / 504103305 / 5801840550</p> <p style="text-align: right;">DX RH</p> <p style="text-align: right;">SX LH</p>
	<p>RIPAROFANGO POSTERIORE P.P. - NERO REAR MUDGUARD P.P. - BLACK</p> <p>COS.PEL. ref. SIMILAR ref. 206.90198 504138503</p> <p>206.90197 504138502</p> <p style="text-align: right;">DX RH</p> <p style="text-align: right;">SX LH</p>

ALL ITEMS MENTIONED IN OUR CATALOGUE ARE NOT ORIGINAL PARTS BUT PERFECTLY INTERCHANGEABLE WITH THEM.

GOVERNING LEGISLATIONS FOR THE SALE OF OUR PRODUCTS DIFFER IN EACH COUNTRY.

INFRINGEMENTS, IF ANY, OF LOCAL LEGISLATIONS ARE RESPONSIBILITY OF THE RETAILER IN THE COUNTRY OF FINAL DISTRIBUTION.



Stralis 2013 HI-WAY - AS

 <p>cm 16,5 cm 84,5 cm 67,5</p>	<p>CALOTTA POST. RIBAS. NERA CON 4 TIRANTI P.P. - NERO REAR MUDGUARD WITH 4 MUDGUARD TENSIONERS P.P. - BLACK</p> <p>COS.PEL. ref. 206.90196 SIMILAR ref. 2997670 / 41298976 DX-SX RH-LH</p> <p>(206.90199 versione senza i tiranti)</p>
 <p>cm 16,5 cm 84,5 cm 67,5</p>	<p>CALOTTA POSTERIORE RIBASSATA P.P. - NERO REAR MUDGUARD P.P. - BLACK</p> <p>COS.PEL. ref. 206.90199 SIMILAR ref. 41298976 DX-SX RH-LH</p> <p>Relativo tirante 1006.80696 - (206.90196 versione con i tiranti)</p>
 <p>cm 21 cm 95,5 cm 67,5</p>	<p>CALOTTA POSTERIORE P.P. - NERO REAR MUDGUARD P.P. - BLACK</p> <p>COS.PEL. ref. 206.90200 SIMILAR ref. 41298975 DX-SX RH-LH</p> <p>Relativo tirante 1006.80696 - (206.90208 versione con i tiranti)</p>
 <p>cm 70 cm 70</p>	<p>MEZZO PARAFANGO POSTERIORE P.P. - PARTE ANTERIORE - NERO - STAFFA INTERNA LUNGA MUDGUARD P.P. - FRONT SIDE - BLACK - INTERNAL BRACKET LONG</p> <p>COS.PEL. ref. 206.90201 SIMILAR ref. 41298962 DX-SX RH-LH</p> <p>Kit : 1006.880751</p>
 <p>cm 70 cm 70</p>	<p>MEZZO PARAFANGO POSTERIORE P.P. - PARTE POSTERIORE - NERO - STAFFA INTERNA CORTA MUDGUARD P.P. - REAR SIDE - BLACK - INTERNAL BRACKET SHORT</p> <p>COS.PEL. ref. 206.90202 SIMILAR ref. 41298964 DX-SX RH-LH</p> <p>Kit : 1006.80752</p>
	<p>COPERCHIO PARAFANGO POSTERIORE P.P. - PARTE POSTERIORE - NERO - CON STAFFA COVER REAR MUDGUARD P.P. - REAR SIDE - BLACK - WITH BRACKET</p> <p>COS.PEL. ref. 206.90204 SIMILAR ref. 41298974 DX RH</p> <p>206.90203 41298973 SX LH</p>
	<p>COPERCHIO PARAFANGO POSTERIORE P.P. - ANTERIORE - NERO COVER REAR MUDGUARD P.P. - FRONT - BLACK</p> <p>COS.PEL. ref. 206.90206 SIMILAR ref. 41298888 DX RH</p> <p>206.90205 41298887 SX LH</p>
 <p>cm 70 cm 70</p>	<p>MEZZO PARAFANGO POSTERIORE SENZA STAFFE P.P. - PARTE ANTERIORE - NERO - SENZA STAFFE COVER REAR MUDGUARD W/O BRACKETS P.P. - FRONT SIDE - BLACK - WITHOUT BRACKETS</p> <p>COS.PEL. ref. 206.90207 SIMILAR ref. - DX-SX RH-LH</p> <p>Senza staffe</p>

Stralis 2013 HI-WAY - AS

	<p>CALOTTA POSTERIORE CON 4 TIRANTI P.P. - NERO REAR MUDGUARD WITH 4 M. TENSIONERS P.P. - BLACK</p> <p>COS.PEL. ref. 206.90208 SIMILAR ref. 2997670 / 41213696 / 41298975 DX-SX RH-LH (206.90200 versione senza i tiranti)</p>
	<p>CALOTTA POSTERIORE P.P. - NERO REAR MUDGUARD P.P. - BLACK</p> <p>COS.PEL. ref. 206.92100 SIMILAR ref. 41289079 DX-SX RH-LH Relativo tirante 1006.80696 - (206.92107 versione con i tiranti)</p>
	<p>MEZZO PARAFANGO POSTERIORE PARTE ANT. P.P. - NERO REAR MUDGUARD FRONT SIZE P.P. - BLACK</p> <p>COS.PEL. ref. 206.92102 SIMILAR ref. 41288786 / 41289082 / 5801698294 DX RH 206.92101 41288784 / 41289081 / 5801698293 SX LH</p>
	<p>MEZZO PARAFANGO POSTERIORE PARTE POST. P.P. - NERO REAR MUDGUARD REAR SIDE P.P. - BLACK</p> <p>COS.PEL. ref. 206.92104 SIMILAR ref. 41288785 / 41289088 DX RH 206.92103 41288783 / 41289087 SX LH</p>
	<p>SUPPORTO FARO POSTERIORE P.P. - NERO LENS BRACKET P.P. - BLACK</p> <p>COS.PEL. ref. 206.92106 SIMILAR ref. 41288777 DX RH 206.92105 41288776 SX LH</p>
	<p>CALOTTA PARAFANGO POSTERIORE CON 4 TIRANTI P.P. - NERO REAR MUDGUARD WITH 4 M. TENSIONERS P.P. - BLACK</p> <p>COS.PEL. ref. 206.92107 SIMILAR ref. 2997670 / 41213696 / 41289079 DX-SX RH-LH (206.92100 versione senza i tiranti)</p>
	<p>PEDANA CON FORI MODANATURA P.P.G.F. - NERO FOOTSTEP WITH HOLES P.P.G.F. - BLACK</p> <p>COS.PEL. ref. 306.80012 SIMILAR ref. 2997739 / 504136556 / 504368383 DX RH 306.80013 2997738 / 504136555 / 504368379 SX LH</p>
	<p>PEDANA SENZA FORI P.P.G.F. - NERA FOOTSTEP W/O HOLES P.P.G.F. - BLACK</p> <p>COS.PEL. ref. 306.80022 SIMILAR ref. 504368373 DX RH 306.80023 504368376 SX LH</p>

Stralis 2013 HI-WAY - AS

	<p>PEDANA P.P.G.F. - BIANCO SMALTATO FOOTSTEP P.P.G.F. - WHITE ENAMELLED COS.PEL. ref. SIMILAR ref. 306.80026 2997119 / 500375431 DX RH</p> <p>306.80027 306.80030 : ROSSO MARANELLO 2997119 / 500375431 SX LH</p> <p>306.80031 : ROSSO MARANELLO</p>
	<p>PARAURTI ANTERIORE P.P.T./P.P.G.F. - BIANCO SMALTATO FRONT BUMPER P.P.T./P.P.G.F. - WHITE ENAMELLED COS.PEL. ref. SIMILAR ref. 406.90081 504186929 / 504284315 / 5801603578 / 5801603597 406.90079 : ROSSO MARANELLO 406.90076 : NERO OPACO</p>
	<p>PARAURTI ANTERIORE P.P.T./P.P.G.F. - NERO (NON VERNICIATO) FRONT BUMPER P.P.T./P.P.G.F. - BLACK (NO PAINT) COS.PEL. ref. SIMILAR ref. 406.90085 504186928 / 504287143</p>
	<p>PARAURTI ANTERIORE P.P.T./P.P.G.F. - PRIMER FRONT BUMPER P.P.T./P.P.G.F. - PRIMER COS.PEL. ref. SIMILAR ref. 406.90090 504186929 / 504284315 / 5801603578 / 5801603597</p>
	<p>ANGOLO SOTTOPARAURTI P.P. - NERO CORNER BUMPER P.P. - BLACK COS.PEL. ref. SIMILAR ref. 406.92070 5801562167 DX RH</p> <p>406.92071 5801562166 SX LH</p>
	<p>SOTTOPARAURTI CENTRALE P.P. - NERO CENTRAL BUMPER P.P. - BLACK COS.PEL. ref. SIMILAR ref. 406.92072 5801562137</p>
	<p>TAPPO TELECAMERA PER PARAURTI COVER BUMPER COS.PEL. ref. SIMILAR ref. 406.92077 5801974516</p>
	<p>PARAURTI ANTERIORE P.P.T. - P.P.G.F. - CON FORO RADAR - BIANCO SMALTATO FRONT BUMPER P.P.T. - P.P.G.F. - WITH RADAR HOLE - WHITE ENAMELLED COS.PEL. ref. SIMILAR ref. 406.92081 5802055590</p> <p>406.92079 : ROSSO MARANELLO 406.92080 : NERO OPACO</p>

Stralis 2013 HI-WAY - AS

	<p>PARAURTI ANTERIORE CON RADAR P.P.T. - P.P.G.F. - CON FORO RADAR - NERO (NON VERNICIATO) FRONT BUMPER P.P.T. - P.P.G.F. - WITH RADAR HOLE - (NO PAINTED)</p> <p>COS.PEL. ref. SIMILAR ref. 406.92085 5802055590 / 5802067261</p>
	<p>PARAURTI ANTERIORE CON RADAR P.P.T. - P.P.G.F. - PRIMER - CON FORO RADAR FRONT BUMPER P.P.T. - P.P.G.F. - PRIMER - WITH RADAR HOLE</p> <p>COS.PEL. ref. SIMILAR ref. 406.92090 5802055590 / 5802055590 / 5802062276 / 5802067033</p>
	<p>SPORTELLO CENTRALE PARAURTI A.B.S. - NERO CENTRAL COVER BUMPER A.B.S. - BLACK</p> <p>COS.PEL. ref. SIMILAR ref. 406.90092 504187294</p>
	<p>TAPPO PARAURTI P.P. - NERO BUMPER COVER P.P. - BLACK</p> <p>COS.PEL. ref. SIMILAR ref. 406.90093 504187339</p>
	<p>SPORTELLO SUPERIORE PARAURTI P.P. - NERO UPPER BUMPER COVER P.P. - BLACK</p> <p>COS.PEL. ref. SIMILAR ref. 406.90094 504187426 DX RH</p> <p>406.90095 504187427 SX LH</p>
	<p>SPORTELLO LATERALE PARAURTI P.P. - NERO SIDE BUMPER COVER P.P. - BLACK</p> <p>COS.PEL. ref. SIMILAR ref. 406.90096 504187506 DX RH</p> <p>406.90097 504187507 SX LH</p>
	<p>SUPPORTO FENDI INTERNO P.P.G.F. - NERO FOG LAMP BRACKET P.P.G.F. - BLACK</p> <p>COS.PEL. ref. SIMILAR ref. 406.90098 504173478 DX RH</p> <p>406.90099 504173477 SX LH</p>
	<p>PEDANA PARAURTI P.P. - NERO UPPER BUMPER FOOTSTEP P.P. - BLACK</p> <p>COS.PEL. ref. SIMILAR ref. 406.90102 500380111 / 504032325 / 504194669</p>

ALL ITEMS MENTIONED IN OUR CATALOGUE ARE NOT ORIGINAL PARTS BUT PERFECTLY INTERCHANGEABLE WITH THEM.

GOVERNING LEGISLATIONS FOR THE SALE OF OUR PRODUCTS DIFFER IN EACH COUNTRY.







INFRINGEMENTS, IF ANY, OF LOCAL LEGISLATIONS ARE RESPONSIBILITY OF THE RETAILER IN THE COUNTRY OF FINAL DISTRIBUTION.





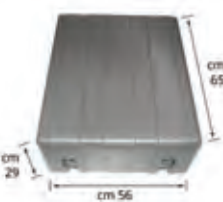



Stralis 2013 HI-WAY - AS

	<p>PEDANA PARAURTI P.P. - NERO UPPER BUMPER FOOTSTEP P.P. - BLACK</p> <p>COS.PEL. ref. SIMILAR ref. 406.90103 504135514</p>
	<p>CORNICE FENDINEBBIA CROMATA A.B.S. - CROMATA FOG LAMP BEZEL CHROMED A.B.S. - CHROMED</p> <p>COS.PEL. ref. SIMILAR ref. 406.92074 5801584081 DX RH</p> <p>406.92073 5801584082 SX LH</p>
	<p>CORNICE FENDINEBBIA CROMATA SENZA LAVAFARO A.B.S. - SENZA LAVAFARO FOG LAMP BEZEL CHROMED W/O HL WASHER A.B.S. - W/O HEADLIGHT WASHER</p> <p>COS.PEL. ref. SIMILAR ref. 406.92076 504135530 DX RH</p> <p>406.92075 504135532 SX LH</p>
	<p>SPOILER TETTO MOBILE Euro 5/6 SPOILER Euro 5/6</p> <p>COS.PEL. ref. SIMILAR ref. 606.92300 5801592113</p> <p>Solo ricambistica, kit staffe non fornito</p>
	<p>VISIERA STRALIS 2013 SUN VISOR STRALIS 2013</p> <p>COS.PEL. ref. SIMILAR ref. 706.92100 5801715565 / 5801715570 con staffe Relativo kit staffe 1006.92100</p>
	<p>DEFLETTORE LATERALE SUPERIORE S.M.C. - Euro 5/6 LATERAL DEFLECTOR S.M.C. - Euro 5/6</p> <p>COS.PEL. ref. SIMILAR ref. 806.92302 5801592119 DX RH</p> <p>806.92301 5801592114 SX LH</p> <p>Solo ricambistica, kit staffe non fornito</p>
	<p>DEFLETTORE LATERALE INFERIORE S.M.C. - Euro 5/6 LATERAL DEFLECTOR S.M.C. - Euro 5/6</p> <p>COS.PEL. ref. SIMILAR ref. 806.92304 5801672866 DX RH</p> <p>Solo ricambistica, kit staffe non fornito</p>
	<p>DEFLETTORE LATERALE INFERIORE S.M.C. - Euro 6 LATERAL DEFLECTOR S.M.C. - Euro 6</p> <p>COS.PEL. ref. SIMILAR ref. 806.92305 5801673301 SX LH</p> <p>Solo ricambistica, kit staffe non fornito</p>

Stralis 2013 HI-WAY - AS

	<p>CONVOGLIATORE ARIA A.B.S. AIR CONVEYOR A.B.S. COS.PEL. ref. SIMILAR ref. 906.92190 5801546918 DX RH</p> <p>906.92191 5801552904 SX LH</p>
	<p>CERNIERA CALANDRA ANTERIORE P.P.G.F. BRACKET P.P.G.F. COS.PEL. ref. SIMILAR ref. 1006.70604 500368694 / 504306106</p>
	<p>GRIGLIA PEDANA PLASTICA FOOTSTEP GRILLE PLASTIC COS.PEL. ref. SIMILAR ref. 1006.80540 504211437 DX RH</p> <p>1006.80541 504211438 SX LH</p> <p>Relativa pedana: 206.80540 / 206.90096 / 206.90098 Relativa pedana: 206.80541 / 206.90097 / 206.90099</p>
 <p>cm 65 cm 29 cm 56</p>	<p>COPRI BATTERIA P.P. BATTERY COVER P.P. COS.PEL. ref. SIMILAR ref. 1006.90106 98474429</p>
	<p>SUPPORTO MOLLA GAS P.P.G.F. GAS SPRING SUPPORT P.P.G.F. COS.PEL. ref. SIMILAR ref. 1006.90108 500396838</p>
	<p>BOTTONE PEDANA PARAURTI FRONT BUMPER CLIP COS.PEL. ref. SIMILAR ref. 1006.90110 504194581</p>
  	<p>FANALINO LATERALE 4 LED SIDE LAMP 4 LED COS.PEL. ref. SIMILAR ref. 002986 5801631615 DX-SX RH-LH</p>
	<p>PORTALAMPADA LAMP BULB HOLDER COS.PEL. ref. SIMILAR ref. 002987 -</p> <p>Per lampada / For lamp : 002988</p>

Stralis 2013 HI-WAY - AS

 	<p>FANALINO LATERALE W5W SIDE LAMP W5W</p> <p>COS.PEL. ref. 002988 SIMILAR ref. 41200664</p> <p style="text-align: right;">DX-SX RH-LH</p> <p style="text-align: right;">Relativo portalampada 002987</p>
 	<p>FANALINO ANTERIORE DX FRONT LAMP</p> <p>COS.PEL. ref. 1606.92802 SIMILAR ref. 5801572018 / 5801755107 DX RH</p> <p>1606.92803 Relativo portalampada 1606.92810 5801572024 / 5801755108 SX LH</p> <p style="text-align: right;">Relativo portalampada 1606.92810</p>
	<p>FANALINO VISIERA SUN VISOR'S MARKER</p> <p>COS.PEL. ref. 1606.92804 SIMILAR ref. 5801546522 DX RH</p> <p>1606.92805 5801546548 SX LH</p>
 	<p>FANALINO LATERALE 3 FORI SIDE LAMP 3 HOLES</p> <p>COS.PEL. ref. 1606.92806 SIMILAR ref. 5801572074 / 5801754885 DX RH</p> <p>1606.92807 5801572080 / 5801754886 SX LH</p>
	<p>PORTALAMPADA LAMP BULB HOLDER</p> <p>COS.PEL. ref. 1606.92810 SIMILAR ref. -</p> <p style="text-align: right;">Per / For : 1606.92802/3 - 1606.90604/5 - 1604.10604/5</p>
	<p>PORTALAMPADA LAMP BULB HOLDER</p> <p>COS.PEL. ref. 1606.92811 SIMILAR ref. -</p> <p style="text-align: right;">Per lampada / For lamp : 1606.90602/3</p>
	<p>PROIETTORE CON CENTRALINA XENON - D1S - LED - CON CENTRALINA HEADLAMP WITH CONTROL UNIT XENON - D1S - LED - WITH CONTROL UNIT</p> <p>COS.PEL. ref. 1606.92798 SIMILAR ref. 5801745442 DX RH</p> <p>1606.92799 Relativa centralina 1606.92812 5801745441 SX LH</p> <p style="text-align: right;">Relativa centralina 1606.92812</p>
 	<p>PROIETTORE CORRETTORE ASSETTO MANUALE SENZA CENTRALINA HEADLAMP MANUAL LOAD LEVEL ADJUSTEMENT WITHOUT ELECTRONIC CONTROL UNIT</p> <p>COS.PEL. ref. 1606.92808 SIMILAR ref. - DX RH</p> <p>1606.92809 - SX LH</p>

Stralis 2013 HI-WAY - AS

	<p>SERRATURA PORTA ELETTRICA ELECTRIC DOOR LOCK</p> <p>COS.PEL. ref. SIMILAR ref. 1706.60906 98411951 / 98416419</p> <p>1706.60905 98411952 / 98416424</p> <p style="text-align: right;">DX RH SX LH</p>
	<p>ARRESTO PORTA DOOR STOP</p> <p>COS.PEL. ref. SIMILAR ref. 1706.60908 5802132946 / 99476267</p> <p>1706.60907 5802132944 / 99476268</p> <p style="text-align: right;">DX RH SX LH</p>
	<p>GUIDA VETRO WINDOW FRAME</p> <p>COS.PEL. ref. SIMILAR ref. 1806.60134 98484152</p> <p>1806.60133 98404902</p> <p style="text-align: right;">DX RH SX LH</p>
	<p>ALZACRISTALLI ELETTRICO - CON MOTORINO - 2 PIN WINDOW REGULATOR ELECTRIC - WITH MOTOR - 2 PIN</p> <p>COS.PEL. ref. SIMILAR ref. 1906.60032 2997195 / 98407721 / 99487780</p> <p>1906.60033 2997196 / 98407722 / 99487781</p> <p style="text-align: right;">DX RH SX LH</p>
	<p>ALZACRISTALLI ELETTRICO - CON MOTORINO - 2 PIN WINDOW REGULATOR ELECTRIC - WITH MOTOR - 2 PIN</p> <p>COS.PEL. ref. SIMILAR ref. 1906.90030 50404988 / 504157968 / 5801324907</p> <p>1906.90031 50404989 / 504157969 / 5801324893</p> <p style="text-align: right;">DX RH SX LH</p>
	<p>VASCHETTA ESPANSIONE EXPANSION TANK</p> <p>COS.PEL. ref. SIMILAR ref. 2106.92080 41215632</p>
	<p>TIRANTE COPRI BATTERIA CORTO 140 mm MUDGUARD TENSIONER SHORT 140 mm</p> <p>COS.PEL. ref. SIMILAR ref. 1006.90107 4605163</p>
	<p>TIRANTE COPRI BATTERIA LUNGO 144 mm MUDGUARD TENSIONER LONG 144 mm</p> <p>COS.PEL. ref. SIMILAR ref. 1006.90109 4784894</p>

Stralis 2013 HI-WAY - AS

	<p>KIT PER CONNESSIONI ELETTRICHE Connettore HDSCS singolo KIT FOR ELECTRICAL JOINTS Connector HDSCS simple</p> <p>COS.PEL. ref. SIMILAR ref. 003119 -</p>
	<p>FANALE POSTERIORE REAR-LIGHT Interasse tra le viti 15,3 cm Inter-axis 15,3 cm</p> <p>COS.PEL. ref. SIMILAR ref. 006154 5801363431 DX RH</p> <p>006153 5801363428 SX LH</p> <p>TRASPARENTE / LENS 011110 93161844 DX-SX RH-LH</p>
	<p>FANALE POSTERIORE REAR-LIGHT Interasse tra le viti 15,3 cm Inter-axis 15,3 cm</p> <p>COS.PEL. ref. SIMILAR ref. 006155 5801363432 DX RH</p> <p>006157 Con Cicalino / With Buzzer SX LH</p> <p>TRASPARENTE / LENS 011110 93161844 DX-SX RH-LH</p>
	<p>FANALE POSTERIORE REAR-LIGHT LED - 24V - CONNETTORE LATERALE HDSCS LED - 24V - LATERAL CONNECTOR HDSCS</p> <p>COS.PEL. ref. SIMILAR ref. 1506.92000 5802000573 DX RH</p> <p>1506.92001 Relativo connettore 003119 SX LH</p> <p>TRASPARENTE / LENS 1503.45100 - DX RH</p> <p>1503.45101 - SX LH</p>
	<p>FANALE POSTERIORE REAR-LIGHT LED - 24V - CONNETTORE LATERALE HDSCS LED - 24V - LATERAL CONNECTOR HDSCS</p> <p>COS.PEL. ref. SIMILAR ref. 1506.92002 5802000767 DX RH</p> <p>1506.92003 Con cicalino / With buzzer - Relativo connettore 003119 SX LH</p> <p>TRASPARENTE / LENS 1503.45100 - DX RH</p> <p>1503.45101 - SX LH</p>
	<p>FANALE POSTERIORE REAR-LIGHT LED - 24V - CONNETTORE POSTERIORE HDSCS LED - 24V - REAR CONNECTOR HDSCS</p> <p>COS.PEL. ref. SIMILAR ref. 1506.92004 5802000770 DX RH</p> <p>1506.92005 Relativo connettore 003119 SX LH</p> <p>TRASPARENTE / LENS 1503.45100 - DX RH</p> <p>1503.45101 - SX LH</p>
	<p>FANALE POSTERIORE REAR-LIGHT LED - 24V - CONNETTORE POSTERIORE HDSCS LED - 24V - REAR CONNECTOR HDSCS</p> <p>COS.PEL. ref. SIMILAR ref. 1506.92006 5802000772 DX RH</p> <p>1506.92007 Con cicalino / With buzzer - Relativo connettore 003119 SX LH</p> <p>TRASPARENTE / LENS 1503.45100 - DX RH</p> <p>1503.45101 - SX LH</p>
	<p>FANALE POSTERIORE REAR-LIGHT 24V - CONNETTORE LATERALE HDSCS 24V - SIDE CONNECTOR HDSCS</p> <p>COS.PEL. ref. SIMILAR ref. 1506.92008 5801637201 DX RH</p> <p>1506.92009 Relativo connettore 003119 SX LH</p> <p>TRASPARENTE / LENS 1506.92100 42575877 DX RH</p> <p>1506.92101 42575315 SX LH</p>

Stralis 2013 HI-WAY - AS

	<p>FANALE POSTERIORE REAR-LIGHT 24V - CONNETTORE LATERALE HDSCS 24V - SIDE CONNECTOR HDSCS</p> <p>COS.PEL. ref. 1506.92010 SIMILAR ref. 5801637702 DX RH Con cicalino / With buzzer - Relativo connettore 003119</p> <p>TRASPARENTE / LENS 1506.92100 42575877 DX RH</p>
	<p>FANALE POSTERIORE REAR-LIGHT 24V - CONNETTORE POSTERIORE HDSCS 24V - REAR CONNECTOR HDSCS</p> <p>COS.PEL. ref. 1506.92012 SIMILAR ref. 5801757328 DX RH Relativo connettore 003119 1506.92011 5801637182 SX LH Relativo connettore 003119</p> <p>TRASPARENTE / LENS 1506.92100 42575877 DX RH 1506.92101 42575315 SX LH</p>
	<p>FANALE POSTERIORE REAR-LIGHT 24V - CONNETTORE POSTERIORE HDSCS 24V - REAR CONNECTOR HDSCS</p> <p>COS.PEL. ref. 1506.92014 SIMILAR ref. 5801757326 DX RH Con cicalino / With buzzer - Relativo connettore 003119 1506.92013 5802055272 SX LH Con luce targa / With plate light - Relativo connettore 003119</p> <p>TRASPARENTE / LENS 1506.92100 42575877 DX RH 1506.92101 42575315 SX LH</p>

Astra HD7



RIPAROFANGO POSTERIORE

G.R.P.

REAR MUDGUARD

G.R.P.

COS.PEL. ref.

SIMILAR ref.

206.07200

172145

DX RH

206.07201

172146

SX LH



PEDANA PARAFANGO

G.R.P. - BIANCO

MUDGUARD FOOTSTEP

G.R.P. - WHITE

COS.PEL. ref.

SIMILAR ref.

306.07300

193997

DX RH

306.07301

193996

SX LH



	<p>GRIGLIA S.M.C. GRILLE S.M.C.</p> <p>COS.PEL. ref. SIMILAR ref. 106.08100 500431530</p>
	<p>PEDANA PARAFANGO S.M.C. - BIANCO MUDGUARD FOOTSTEP S.M.C. - WHITE</p> <p>COS.PEL. ref. SIMILAR ref.</p> <p>306.08300 136213 / 500420559 DX RH</p> <p>306.08301 136212 / 500420558 SX LH</p>

Astra HD9



	<p>GRIGLIA S.M.C. GRILLE S.M.C.</p> <p>COS.PEL. ref. SIMILAR ref. 106.09100 5949782801</p>
	<p>PEDANA PARAFANGO C/ALETTA DOPPIA S.M.C. - MUDGUARD FOOTSTEP S.M.C. -</p> <p>COS.PEL. ref. SIMILAR ref. 306.09300 5949800616 DX RH</p> <p>306.09301 5949800615 SX LH</p>
	<p>PEDANA PARAFANGO C/ALETTA SINGOLA S.M.C. - MUDGUARD FOOTSTEP S.M.C. -</p> <p>COS.PEL. ref. SIMILAR ref. 306.09302 5949800619 DX RH</p> <p>306.09303 5949800617 SX LH</p>
	<p>PEDANA PARAFANGO S/ALETTA S.M.C. - MUDGUARD FOOTSTEP S.M.C. -</p> <p>COS.PEL. ref. SIMILAR ref. 306.09304 5949800621 DX RH</p> <p>306.09305 5949800620 SX LH</p>
	<p>PEDANA PARAFANGO S/ALETTA C/MANIGLIA S.M.C. - MUDGUARD FOOTSTEP S.M.C. -</p> <p>COS.PEL. ref. SIMILAR ref. 306.09306 5949801378 DX RH</p> <p>306.09307 5949801377 SX LH</p>

	CANTONALE S.M.C. CANTONAL S.M.C.		
	COS.PEL. ref. 906.09900	SIMILAR ref. 5949782808	DX RH
	906.09901	5949782807	SX LH



ARTICOLI SU ORDINAZIONE SOLO IN GRANDI QUANTITATIVI (SE NON A MAGAZZINO)
ITEMS MADE TO ORDER ONLY IN BIG QUANTITY (FOR NEW QUANTITY WE CHECK THE STOCK)

<p>AD ESAURIMENTO SCORTE UNTIL SELL-OUT</p> 	<p>FRONTALE METALLO - NERO FRONT PANEL STEEL - BLACK</p> <p>COS.PEL. ref. SIMILAR ref. 106.68201 4588444</p> <p style="text-align: right;">SX LH</p>
<p>AD ESAURIMENTO SCORTE UNTIL SELL-OUT</p> 	<p>MASCHERINA CENTRALE METALLO - NERO CENTRE GRILLE STEEL - BLACK</p> <p>COS.PEL. ref. SIMILAR ref. 106.68202 4597675</p>
<p>AD ESAURIMENTO SCORTE UNTIL SELL-OUT</p> 	<p>PARAFANGO METALLO - NERO MUDGUARD STEEL - BLACK</p> <p>COS.PEL. ref. SIMILAR ref. 206.89964 4689964</p> <p style="text-align: right;">DX RH</p>



AD ESAURIMENTO SCORTE
UP TILL SELLS-OUT



PARAFANGO LATERALE

G.R.P.

SIDE MUDGUARD

G.R.P.

COS.PEL. ref.

206.08200

SIMILAR ref.

60164734

DX RH

Bus Citelis



CANTONALE ANTERIORE
CODICE COLORE RAL 5002
FRONT CORNER BUMPER
COLOUR CODE RAL 5002

COS.PEL. ref.

416.00011

SIMILAR ref.

5006182631

SX LH



	<p>RIVESTIMENTO ANTERIORE CON DELFINO CODICE COLORE RAL 2000 FRONT CENTRAL BUMPER COLOUR CODE RAL 2000</p> <p>COS.PEL. ref. SIMILAR ref. 416.00060 5006218166</p>
	<p>RIVESTIMENTO ANTERIORE SENZA DELFINO CODICE COLORE RAL 2000 FRONT CENTRAL BUMPER COLOUR CODE RAL 2000</p> <p>COS.PEL. ref. SIMILAR ref. 416.00061 5006218166</p>
	<p>PARAURTI ANTERIORE CODICE COLORE RAL 5002 FRONT BUMPER COLOUR CODE RAL 5002</p> <p>COS.PEL. ref. SIMILAR ref. 416.00062 93168568</p>
	<p>RIVESTIMENTO ESTERNO ANTERIORE FRONT BUMPER</p> <p>COS.PEL. ref. SIMILAR ref. 416.00067 99442399</p> <p style="text-align: right;">SX LH</p>
	<p>PARAURTI POSTERIORE CODICE COLORE RAL 5002 REAR BUMPER COLOUR CODE RAL 5002</p> <p>COS.PEL. ref. SIMILAR ref. 416.00070 5006221163</p>

Bus Arway



PARAURTI ANTERIORE CENTRALE
FRONT CENTRAL BUMPER

COS.PEL. ref. SIMILAR ref.
416.00020 504105684



PARAURTI POSTERIORE CENTRALE
REAR CENTRAL BUMPER

COS.PEL. ref. SIMILAR ref.
416.00030 504097988



Parti di ricambio adattabili a:
Spare parts suitable to:



C.D.S.M.A









 <p>cm 21</p>	<p>PEDANA PARAFANGO S.M.C. - NERO MUDGUARD FOOTSTEP S.M.C. - BLACK COS.PEL. ref. SIMILAR ref. 207.02000 85612100004 207.02001 85612100003</p> <p style="text-align: right;">DX RH SX LH</p>
<p>AD ESAURIMENTO SCORTE INVT9, SGL3-4HTF</p> 	<p>RIPAROFANGO POSTERIORE S.M.C. - PRIMER REAR MUDGUARD S.M.C. - PRIMER COS.PEL. ref. SIMILAR ref. 207.02002 85612100008 207.02003 85612100007</p> <p style="text-align: right;">DX RH SX LH</p>
<p>AD ESAURIMENTO SCORTE INVT9, SGL3-4HTF</p> 	<p>PARAFANGO ANTERIORE RUOTA ANTERIORE S.M.C. - PRIMER FRONT MUDGUARD FRONT WHEEL S.M.C. - PRIMER COS.PEL. ref. SIMILAR ref. 207.02004 85612300028</p> <p style="text-align: right;">DX RH</p>
	<p>PARAURTI ANTERIORE P.P.G.F. - GRIGIO FRONT BUMPER P.P.G.F. - GREY COS.PEL. ref. SIMILAR ref. 407.02090 85416104002</p>
	<p>PARAURTI ANTERIORE CON FORI FENDI P.P.G.F. - GRIGIO FRONT BUMPER WITH HOLES P.P.G.F. - GREY COS.PEL. ref. SIMILAR ref. 407.02091 85416104003</p>



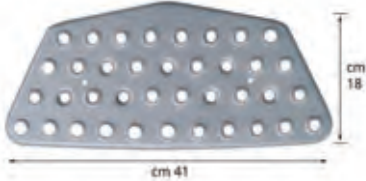

	<p>PEDANA PARAFANGO S.M.C. - GRIGIO FOOTSTEP MUDGUARD S.M.C. - GREY COS.PEL. ref. SIMILAR ref.</p> <p>307.25200 81615100274 / 81615100820 / 81615100942 DX RH Griglia / grille : 1007.05187</p> <p>307.25201 81615100275 / 81615100821 / 81615100941 SX LH Griglia / grille : 1007.05187</p>
	<p>PEDANA PARAFANGO S.M.C. - GRIGIO FOOTSTEP MUDGUARD S.M.C. - GREY COS.PEL. ref. SIMILAR ref.</p> <p>307.25202 81615100276 / 81615100812 DX RH Griglia / grille : 1007.05188</p> <p>307.25203 81615100277 / 81615100813 SX LH Griglia / grille : 1007.05188</p>
	<p>PEDANA PARAFANGO ALETTA DOPPIA S.M.C. - GRIGIO FOOTSTEP MUDGUARD S.M.C. - GREY COS.PEL. ref. SIMILAR ref.</p> <p>307.25204 81615100562 / 81615100564 / 81615100810 DX RH Griglia / grille : 1007.05188</p> <p>307.25205 81615100563 / 81615100565 / 81615100811 SX LH Griglia / grille : 1007.05188</p>
	<p>PROLUNGA PARAFANGO LAT. CAB. LUNGA S.M.C. - GRIGIO EXTENSION MUDGUARD LONG CAB S.M.C. - GREY COS.PEL. ref. SIMILAR ref.</p> <p>307.25206 81612100382 / 81612100482 / 81612100704 DX RH</p> <p>307.25207 81612100383 / 81612100483 / 81612100699 SX LH</p>
	<p>PROLUNGA PARAFANGO LAT. CAB. LUNGA ALTO S.M.C. - GRIGIO EXTENSION MUDGUARD LONG CAB HIGH TYPE S.M.C. - GREY COS.PEL. ref. SIMILAR ref.</p> <p>307.25208 81612100368 / 81612100486 / 81612100698 DX RH</p> <p>307.25209 81612100369 / 81612100487 / 81612100697 SX LH</p>

 <p>cm 4</p>	<p>PROLUNGA PARAFANGO LATERALE CABINA CORTA S.M.C. - GRIGIO EXTENSION MUDGUARD SHOT CAB S.M.C. - GREY COS.PEL. ref. SIMILAR ref. 307.25210 81612100474 / 81612100692 DX RH 307.25211 81612100475 SX LH</p>
 <p>cm 10</p>	<p>PROLUNGA PARAFANGO LATERALE CABINA CORTA S.M.C. - GRIGIO EXTENSION MUDGUARD SHORT CAB S.M.C. - GREY COS.PEL. ref. SIMILAR ref. 307.25212 81612100478 DX RH 307.25213 81612100479 SX LH</p>
	<p>PEDANA FOOTSTEP COS.PEL. ref. SIMILAR ref. 307.25214 81615100570 / 81615100862 DX RH 307.25215 Griglia / grille : 1007.05187 81615100573 / 81615100861 SX LH Griglia / grille : 1007.05187</p>
 <p>cm 38</p>	<p>PEDANA PARAURTI INFERIORE LOWER BUMPER STEP COS.PEL. ref. SIMILAR ref. 407.00318 81416102900</p>
 <p>cm 57</p>	<p>PARAURTI ANTERIORE FRONT BUMPER COS.PEL. ref. SIMILAR ref. 407.25190 81416100224 / 81416100353 / 81416100359</p>
 <p>cm 43</p>	<p>PARAURTI ANTERIORE S.M.C. - GRIGIO FRONT BUMPER S.M.C. - GREY COS.PEL. ref. SIMILAR ref. 407.25290 81416100223 / 81416100352</p>
	<p>TERMINALE PARAURTI FRONT BUMPER STRIP COS.PEL. ref. SIMILAR ref. 407.25292 81416100334 / 81416100342 DX RH 407.25291 81416100333 / 81416100343 SX LH</p>
	<p>TAPPO PARAURTI FORO LAVAFARI HEADLAMP WASH HOLE BUMPER COVER COS.PEL. ref. SIMILAR ref. 407.25293 81416850059 DX-SX RH-LH</p>

	<p>TAPPO PARAURTI A.B.S. BUMPER COVER A.B.S.</p> <p>COS.PEL. ref. SIMILAR ref. 407.00300 81416850029</p>
	<p>VETRO SPECCHIO GUARDARUOTA NON RISCALDATO - RAGGIO 300 ROOF MIRROR NOT HEATED - RADIUS 300</p> <p>COS.PEL. ref. SIMILAR ref. 507.25500 81637336061 / 81637336067 DX-SX RH-LH</p>
	<p>VETRO SPECCHIO GUARDARUOTA RISCALDATO - RAGGIO 300 ROOF MIRROR HEATED - RADIUS 300</p> <p>COS.PEL. ref. SIMILAR ref. 507.25501 81637336062 / 81637336068 DX-SX RH-LH</p>
	<p>SPECCHIO GUARDARUOTA RAGGIO 300 ROOF MIRROR RADIUS 300</p> <p>COS.PEL. ref. SIMILAR ref. 507.25502 81637306449 / 81637306573</p>
	<p>VETRO SPECCHIO FRONTALE R200 FRONT GLASS R200</p> <p>COS.PEL. ref. SIMILAR ref. 507.25503 81637330116</p>
	<p>SPECCHIO FRONTALE FRONT GLASS</p> <p>COS.PEL. ref. SIMILAR ref. 507.25504 81637306572 / 81637306656 / 81637306660</p>
 <p>cm 205 cm 28 cm 45,5 cm 46 cm 45,5</p>	<p>VISIERA TGL SUN VISOR TGL</p> <p>COS.PEL. ref. SIMILAR ref. 707.25100 81637010055 / 81637010058</p> <p>Relativo kit staffe 1007.25100</p>
	<p>CONVOGLIATORE ARIA EURO 5 Parte esterna AIR CONVEYOR EURO 5</p> <p>COS.PEL. ref. SIMILAR ref. 907.25100 81624100184 / 81624100186 DX RH</p> <p>907.25101 81624100183 / 81624100185 SX LH</p> <p>EURO 5</p>

	<p>CONVOGLIATORE ARIA EURO 5 Parte interna AIR CONVEYOR EURO 5</p> <p>COS.PEL. ref. SIMILAR ref. 907.25102 81624100182 / 81624100188 DX RH</p> <p>907.25103 81624100181 / 81624100187 SX LH</p> <p style="text-align: center;">EURO 5</p>
	<p>GRIGLIA PEDANA SALITA INFERIORE METALLO INNER GRILLE FOOTSTEP METAL</p> <p>COS.PEL. ref. SIMILAR ref. 1007.05187 81615105187 DX-SX RH-LH</p>
	<p>GRIGLIA PEDANA CENTRALE METALLO CENTRAL GRILLE FOOTSTEP METAL</p> <p>COS.PEL. ref. SIMILAR ref. 1007.05188 81615110001</p>
	<p>ALZACRISTALLI ELETTRICO - SENZA MOTORINO WINDOW REGULATOR ELECTRIC - WITHOUT MOTOR</p> <p>COS.PEL. ref. SIMILAR ref. 1907.25000 81626456052 DX RH</p> <p>1907.25001 81626456053 SX LH</p>
	<p>DEFLETTORI LATERALI CON CLIPS SIDEWINDOW DEFLECTORS WITH CLIPS</p> <p>COS.PEL. ref. SIMILAR ref. 3007.00000 -</p>
	<p>DEFLETTORI LATERALI SIDEWINDOW DEFLECTORS</p> <p>COS.PEL. ref. SIMILAR ref. 3007.00001 -</p>
	<p>CICALINO DI RETROMARCIA LC8 destra Cicalino di retromarcia - 24V - 90db BUZZER LC8 right buzzer - 24V - 90db</p> <p>COS.PEL. ref. SIMILAR ref. 003092 -</p>
	<p>KIT PER CONNESSIONI ELETTRICHE Connettore AMP 1,5 singolo KIT FOR ELECTRICAL JOINTS Connector AMP 1,5 simple</p> <p>COS.PEL. ref. SIMILAR ref. 003120 -</p>

	<p>FANALE POSTERIORE REAR-LIGHT CONNETTORE LATERALE AMP 1.5 LATERAL CONNECTOR AMP 1.5</p> <p>COS.PEL. ref. 1507.10000 SIMILAR ref. 8125225-6545 (ex 009214) - Relativo connettore 003120 1507.10001 8125225-6544 (ex 009215) - Relativo connettore 003120</p> <p>TRASPARENTE / LENS 1507.10100 8125229-6060 (ex 011012) 1507.10101 8125229-6059 (ex 011011)</p> <p>DX RH SX LH DX RH SX LH</p>
	<p>FANALE POSTERIORE REAR-LIGHT CONNETTORE LATERALE AMP 1.5 LATERAL CONNECTOR AMP 1.5</p> <p>COS.PEL. ref. 1507.10002 SIMILAR ref. 8125225-6547 Con cicalino / With buzzer (ex 009216) - Connettore 003120</p> <p>TRASPARENTE / LENS 1507.10100 8125229-6060 (ex 011012)</p> <p>DX RH DX RH</p>



TGL Euro 6



	<p>CERNIERA METALLO BRACKET METAL</p> <p>COS.PEL. ref. SIMILAR ref. 107.11102 81611456004</p> <p>107.11103 81611456005</p> <p style="text-align: right;">DX RH</p> <p style="text-align: right;">SX LH</p>
	<p>CALANDRA UP+GF30 FRONT PANEL UP+GF30</p> <p>COS.PEL. ref. SIMILAR ref. 107.26100 81611106090 / 81611106104</p>
	<p>GRIGLIA PER RADIATORE P.P. GRILLE P.P.</p> <p>COS.PEL. ref. SIMILAR ref. 107.26102 81611500147 / 81611500172</p>
	<p>CORNICE FENDINEBBIA PET+PC FOG LAMP FRAME PET+PC</p> <p>COS.PEL. ref. SIMILAR ref. 407.26092 81416100414</p> <p>407.26093 81416100415</p> <p style="text-align: right;">DX RH</p> <p style="text-align: right;">SX LH</p>
	<p>ANGOLO PARAURTI PET+PC - CON FORO LAVAFARO CORNER BUMPER PET+PC - WITH LAMP WASHING HOLE</p> <p>COS.PEL. ref. SIMILAR ref. 407.26096 81416105680</p> <p>407.26097 81416105681</p> <p style="text-align: right;">DX RH</p> <p style="text-align: right;">SX LH</p>

	<p>TAPPO FORO LAVAFARO PARAU RTI PET+PC - GRIGIO HEADLAMP WASH HOLE BUMPER COVER PET+PC - GREY COS.PEL. ref. SIMILAR ref. 407.26098 81416100472 DX RH</p> <p>407.26099 81416100471 SX LH</p>
	<p>ANGOLO PARAU RTI PET+PC - CON FORO LAVAFARO CORNER BUMPER PET+PC - WITH LAMP WASHING HOLE COS.PEL. ref. SIMILAR ref. 407.26100 81416105712 DX RH</p> <p>407.26101 81416105711 SX LH</p>
	<p>SUPPORTO FARO PA6+GF60 HEADLAMP BRACKET PA6+GF60 COS.PEL. ref. SIMILAR ref. 407.26102 81416105728 (81416105700) DX RH</p> <p>407.26103 81416105727 (81416105699) SX LH</p>
	<p>PARAU RTI PET+PC BUMPER PET+PC COS.PEL. ref. SIMILAR ref. 407.26104 81416106684</p>
	<p>PARAU RTI PA6+GF60 BUMPER PA6+GF60 COS.PEL. ref. SIMILAR ref. 407.26105 81416105741 / 81416105746</p>
	<p>PANNELLO CENTRALE PARAU RTI PET+PC CENTRAL PANEL BUMPER PET+PC COS.PEL. ref. SIMILAR ref. 407.26106 81416106806</p>
	<p>TAPPO PARAU RTI FORO LAVAFARO PET+PC - PRIMER HEADLAMP WASH HOLE BUMPER COVER PET+PC - PRIMER COS.PEL. ref. SIMILAR ref. 407.26108 81416100563 DX RH</p> <p>407.26107 81416100562 SX LH</p>
	<p>PORTATARGA P.P. - GRIGIO VEHICLE PLATE SUPPORT P.P. - GREY COS.PEL. ref. SIMILAR ref. 407.26109 81429400304</p>

TGL Euro 6

	<p>PEDANA PARAURTI PET+PC - GRIGIO BUMPER FOOTSTEP PET+PC - GREY</p> <p>COS.PEL. ref. 407.26110 SIMILAR ref. 81416100463</p>
	<p>STAFFA PET+PC BRACKET PET+PC</p> <p>COS.PEL. ref. 407.26111 SIMILAR ref. 81416100464</p>
	<p>CONVOGLIATORE ARIA PBT-ASA+GF30 - BIANCO AIR CONVEYOR PBT-ASA+GF30 - WHITE</p> <p>COS.PEL. ref. 907.26170 SIMILAR ref. 81611100101 DX RH</p> <p>907.26171 81611100100 SX LH</p>
	<p>DEFLETTORE P.P. - NERO AIR CONVEYOR P.P. - BLACK</p> <p>COS.PEL. ref. 907.26172 SIMILAR ref. 81611100124 (81611100099) DX RH</p> <p>907.26173 81611100125 (81611100098) SX LH</p>
	<p>SERRATURA PORTA DOOR LOCK</p> <p>COS.PEL. ref. 1707.00604 SIMILAR ref. 81626806142 DX RH</p> <p>1707.00605 81626806143 SX LH</p>
	<p>CICALINO DI RETROMARCIA LC8 destra Cicalino di retromarcia - 24V - 90db BUZZER LC8 right buzzer - 24V - 90db</p> <p>COS.PEL. ref. 003092 SIMILAR ref. -</p>
	<p>KIT PER CONNESSIONI ELETTRICHE Connettore AMP 1,5 singolo KIT FOR ELECTRICAL JOINTS Connector AMP 1,5 simple</p> <p>COS.PEL. ref. 003120 SIMILAR ref. -</p>
	<p>FANALE POSTERIORE REAR-LIGHT</p> <p>COS.PEL. ref. 1507.10000 SIMILAR ref. 8125225-6545 DX RH (ex 009214) - Relativo connettore 003120</p> <p>1507.10001 8125225-6544 SX LH (ex 009215) - Relativo connettore 003120</p> <p>TRASPARENTE / LENS</p> <p>1507.10100 8125229-6060 (ex 011012) DX RH</p> <p>1507.10101 8125229-6059 (ex 011011) SX LH</p>



	FANALE POSTERIORE REAR-LIGHT		CONNETTORE LATERALE AMP 1.5 LATERAL CONNECTOR AMP 1.5
	COS.PEL. ref. 1507.10002	SIMILAR ref. 8125225-6547 Con cicalino / With buzzer (ex 009216) - Connettore 003120	DX RH
	TRASPARENTE / LENS 1507.10100	8125229-6060	(ex 011012) DX RH







TGM Euro 6







	<p>CERNIERA METALLO BRACKET METAL</p> <p>COS.PEL. ref. SIMILAR ref. 107.11102 81611456004</p> <p>107.11103 81611456005</p> <p style="text-align: right;">DX RH</p> <p style="text-align: right;">SX LH</p>
	<p>CALANDRA UP+GF30 FRONT PANEL UP+GF30</p> <p>COS.PEL. ref. SIMILAR ref. 107.26100 81611106090 / 81611106104</p>
	<p>GRIGLIA PER RADIATORE P.P. GRILLE P.P.</p> <p>COS.PEL. ref. SIMILAR ref. 107.26102 81611500147 / 81611500172</p>
	<p>TAPPO FORO LAVAFARO PARAURTI PET+PC - GRIGIO HEADLAMP WASH HOLE BUMPER COVER PET+PC - GREY</p> <p>COS.PEL. ref. SIMILAR ref. 407.26098 81416100472</p> <p>407.26099 81416100471</p> <p style="text-align: right;">DX RH</p> <p style="text-align: right;">SX LH</p>
	<p>ANGOLO PARAURTI PET+PC - CON FORO LAVAFARO CORNER BUMPER PET+PC - WITH LAMP WASHING HOLE</p> <p>COS.PEL. ref. SIMILAR ref. 407.26100 81416105712</p> <p>407.26101 81416105711</p> <p style="text-align: right;">DX RH</p> <p style="text-align: right;">SX LH</p>

	<p>SUPPORTO FARO PA6+GF60 HEADLAMP BRACKET PA6+GF60 COS.PEL. ref. SIMILAR ref. 407.26102 81416105728 (81416105700) DX RH</p> <p>407.26103 81416105727 (81416105699) SX LH</p>
	<p>TAPPO PARAURTI FORO LAVAFARO PET+PC - PRIMER HEADLAMP WASH HOLE BUMPER COVER PET+PC - PRIMER COS.PEL. ref. SIMILAR ref. 407.26108 81416100563 DX RH</p> <p>407.26107 81416100562 SX LH</p>
	<p>PEDANA PARAURTI PET+PC - GRIGIO BUMPER FOOTSTEP PET+PC - GREY COS.PEL. ref. SIMILAR ref. 407.26110 81416100463</p>
	<p>STAFFA PET+PC BRACKET PET+PC COS.PEL. ref. SIMILAR ref. 407.26111 81416100464</p>
	<p>PARAURTI PET+PC BUMPER PET+PC COS.PEL. ref. SIMILAR ref. 407.27104 81416106685</p>
	<p>PARAURTI PET+PC BUMPER PET+PC COS.PEL. ref. SIMILAR ref. 407.27105 81416105742 / 81416105747</p>
	<p>PEDANA CORNICE PET+PC FOOTSTEP PET+PC COS.PEL. ref. SIMILAR ref. 407.27106 81416106807</p>
	<p>PORTATARGA PET+PC - GRIGIO VEHICLE PLATE SUPPORT PET+PC - GREY COS.PEL. ref. SIMILAR ref. 407.27107 81416106657</p>

TGM Euro 6

	<p>CONVOGLIATORE ARIA PBT-ASA+GF30 - BIANCO AIR CONVEYOR PBT-ASA+GF30 - WHITE COS.PEL. ref. SIMILAR ref. 907.26170 81611100101 DX RH</p> <p>907.26171 81611100100 SX LH</p>
	<p>DEFLETTORE P.P. - NERO AIR CONVEYOR P.P. - BLACK COS.PEL. ref. SIMILAR ref. 907.26172 81611100124 (81611100099) DX RH</p> <p>907.26173 81611100125 (81611100098) SX LH</p>
	<p>SERRATURA PORTA DOOR LOCK COS.PEL. ref. SIMILAR ref. 1707.00604 81626806142 DX RH</p> <p>1707.00605 81626806143 SX LH</p>
	<p>CICALINO DI RETROMARCIA LC8 destra Cicalino di retromarcia - 24V - 90db BUZZER LC8 right buzzer - 24V - 90db COS.PEL. ref. SIMILAR ref. 003092 -</p>
	<p>KIT PER CONNESSIONI ELETTRICHE Connettore AMP 1,5 singolo KIT FOR ELECTRICAL JOINTS Connector AMP 1,5 simple COS.PEL. ref. SIMILAR ref. 003120 -</p>
	<p>FANALE POSTERIORE CONNETTORE LATERALE AMP 1.5 REAR-LIGHT LATERAL CONNECTOR AMP 1.5 COS.PEL. ref. SIMILAR ref. 1507.10000 8125225-6545 (ex 009214) - Relativo connettore 003120 1507.10001 8125225-6544 (ex 009215) - Relativo connettore 003120 TRASPARENTE / LENS 1507.10100 8125229-6060 (ex 011012) 1507.10101 8125229-6059 (ex 011011) DX RH SX LH DX RH SX LH</p>
	<p>FANALE POSTERIORE CONNETTORE LATERALE AMP 1.5 REAR-LIGHT LATERAL CONNECTOR AMP 1.5 COS.PEL. ref. SIMILAR ref. 1507.10002 8125225-6547 Con cicalino / With buzzer (ex 009216) - Connettore 003120 TRASPARENTE / LENS 1507.10100 8125229-6060 (ex 011012) DX RH DX RH</p>



	<p>PEDANA R.I.M. - GRIGIO FOOTSTEP R.I.M. - GREY COS.PEL. ref. SIMILAR ref. 307.00130 81615100130</p> <p>307.00129 81615100129</p> <p style="text-align: right;">DX RH</p> <p style="text-align: right;">SX LH</p>
	<p>PARAURTI ANTERIORE P.P.G.F. - GRIGIO FRONT BUMPER P.P.G.F. - GREY COS.PEL. ref. SIMILAR ref. 407.00001 81416104067</p>
	<p>PARAURTI ANTERIORE CON SPOILER SENZA FORI P.P.G.F. - GRIGIO FRONT BUMPER W/O HOLES P.P.G.F. - GREY COS.PEL. ref. SIMILAR ref. 407.00002 81416104066</p>
	<p>PARAURTI ANTERIORE CON SPOILER 2 FORI FENDI P.P.G.F. - GRIGIO FRONT BUMPER WITH 2 HOLES P.P.G.F. - GREY COS.PEL. ref. SIMILAR ref. 407.00003 81416104071</p>
	<p>PARAURTI ANTERIORE CON SPOILER 4 FORI FENDI P.P.G.F. - GRIGIO FRONT BUMPER WITH 4 HOLES P.P.G.F. - GREY COS.PEL. ref. SIMILAR ref. 407.00004 81416104072</p>

M90 / F90

	<p>SOTTOPARAURTI CON 2 FORI G.R.P. - GRIGIO SPOILER WITH 2 HOLES G.R.P. - GREY</p> <p>COS.PEL. ref. SIMILAR ref. 407.04066 81416130014 / 81416130015</p>
	<p>SOTTOPARAURTO SENZA FORI G.R.P. - GRIGIO SPOILER W/O HOLES G.R.P. - GREY</p> <p>COS.PEL. ref. SIMILAR ref. 407.04067 81416130018 / 81416130019</p>
	<p>SOTTOPARAURTI CON 4 FORI G.R.P. - GRIGIO SPOILER WITH 4 HOLES G.R.P. - GREY</p> <p>COS.PEL. ref. SIMILAR ref. 407.04068 81416130020 / 81416130021</p>
<p>AD ESAURIMENTO SCORTE INTRA SGLL-AMT</p> 	<p>VETRO SPECCHIO RISCALDATO - (375x190mm) MIRROR GLASS HEATED - (375x190mm)</p> <p>COS.PEL. ref. SIMILAR ref. 507.36006 81637336006</p> <p style="text-align: right;">DX-SX RH-LH</p>
	<p>DEFLETTORI LATERALI CON CLIPS SIDEWINDOW DEFLECTORS WITH CLIPS</p> <p>COS.PEL. ref. SIMILAR ref. 3007.00000 -</p>



<p>AD ESAURIMENTO SCORTE (UNTIL SELL-OUT)</p> 	<p>GRIGLIA GRILLE</p> <p>COS.PEL. ref. SIMILAR ref. 107.00043 81611100043</p>
	<p>RIPAROFANGO POSTERIORE P.P. - NERO REAR MUDGUARD P.P. - BLACK</p> <p>COS.PEL. ref. SIMILAR ref. 207.05080 81664100352 DX RH</p> <p>207.05081 81664100353 SX LH</p>
	<p>PARAFANGO LATERALE S.M.C. - GRIGIO - (350mm) SIDE MUDGUARD S.M.C. - GREY - (350mm)</p> <p>COS.PEL. ref. SIMILAR ref. 207.05162 81615105162 DX RH</p> <p>207.05161 81615105161 SX LH</p>
	<p>PARAFANGO LATERALE S.M.C. - GRIGIO - (250mm) SIDE MUDGUARD S.M.C. - GREY - (250mm)</p> <p>COS.PEL. ref. SIMILAR ref. 207.05164 81615105164 DX RH</p> <p>207.05163 81615105163 SX LH</p>
	<p>PARAFANGO ANTERIORE LATERALE (LARGHEZZA CABINA 2440mm) - S.M.C. - GRIGIO MUDGUARD (WIDTH'S CAB 2440mm) - S.M.C. - GREY</p> <p>COS.PEL. ref. SIMILAR ref. 207.05364 81612105364 DX RH</p> <p>207.05363 81612105363 SX LH</p>

ALL ITEMS MENTIONED IN OUR CATALOGUE ARE NOT ORIGINAL PARTS BUT PERFECTLY INTERCHANGEABLE WITH THEM.

GOVERNING LEGISLATIONS FOR THE SALE OF OUR PRODUCTS DIFFER IN EACH COUNTRY.

INFRINGEMENTS, IF ANY, OF LOCAL LEGISLATIONS ARE RESPONSIBILITY OF THE RETAILER IN THE COUNTRY OF FINAL DISTRIBUTION.



	<p>PEDANA S.M.C. - GRIGIO - (250MM) FOOTSTEP S.M.C. - GREY - (250MM) COS.PEL. ref. SIMILAR ref. 307.00226 81615100226 DX RH</p> <p>307.00225 81615100225 SX LH</p>
	<p>PEDANA S.M.C. - GRIGIO - (350mm) FOOTSTEP S.M.C. - GREY - (350mm) COS.PEL. ref. SIMILAR ref. 307.00230 81615100230 DX RH</p> <p>307.00229 81615100229 SX LH</p>
<p>AD ESAURIMENTO SCORTE UNTIL SELL-OUT</p> 	<p>PARAURTI ANTERIORE S.M.C. - GRIGIO - (LARGHEZZA CABINA 2440mm) FRONT BUMPER S.M.C. - GREY - (WIDTH'S CAB 2440mm) COS.PEL. ref. SIMILAR ref. 407.04121 81416104114</p>
	<p>SOTTOPARAURTI P.P. - GRIGIO - (350mm) SPOILER P.P. - GREY - (350mm) COS.PEL. ref. SIMILAR ref. 407.30071 81416130071</p>
	<p>SOTTOPARAURTI P.P. - GRIGIO - (250mm) SPOILER P.P. - GREY - (250mm) COS.PEL. ref. SIMILAR ref. 407.30073 81416130073</p>
	<p>COPERCHIO PARAURTI FRONTALE S.M.C. - GRIGIO FRONT BUMPER COVERING S.M.C. - GREY COS.PEL. ref. SIMILAR ref. 407.00150 81416100150</p>
	<p>TERMINALE PARAURTI S.M.C. - GRIGIO TERMINAL BUMPER S.M.C. - GREY COS.PEL. ref. SIMILAR ref. 407.00152 81416100152 DX RH</p> <p>407.00151 81416100151 SX LH</p>
	<p>COPERCHIO PARAURTI SUPERIORE S.M.C. - GRIGIO UPPER BUMPER COVERING S.M.C. - GREY COS.PEL. ref. SIMILAR ref. 407.00191 81416100191</p>

	<p>CORNICE PARAURTI P.P. - GRIGIO TRIM WIDE P.P. - GREY COS.PEL. ref. SIMILAR ref. 407.04118 81416100166 DX RH</p> <p>407.04119 81416100167 SX LH</p>
	<p>CORNICE PARAURTI CENTRALE P.P. - GRIGIO TRIM CENTER P.P. - GREY COS.PEL. ref. SIMILAR ref. 407.04120 81416100164</p>
	<p>TERMINALE SOTTOPARAURTI A.B.S. (mm350) - GRIGIO TERMINAL SPOILER A.B.S. (mm350) - GREY COS.PEL. ref. SIMILAR ref. 407.30070 81416130080 DX RH</p> <p>407.30069 81416130081 SX LH</p>
	<p>TERMINALE SOTTOPARAURTI A.B.S. - GRIGIO - (250mm) TERMINAL SPOILER A.B.S. - GREY - (250mm) COS.PEL. ref. SIMILAR ref. 407.30074 81416130078 DX RH</p> <p>407.30075 81416130079 SX LH</p>
	<p>VETRO SPECCHIO GRANDANGOLO - RISCALDATO - R/300 MIRROR GLASS WIDE ANGLE - HEATED - RADIUS/300 COS.PEL. ref. SIMILAR ref. 501.89373 81637330069 DX RH</p>
	<p>VETRO SPECCHIO RISCALDATO - (370x190mm) MIRROR GLASS HEATED - (370x190mm) COS.PEL. ref. SIMILAR ref. 504.99026 81637330067 / 81637330075 DX-SX RH-LH</p>
	<p>SPECCHIO RETROVISORE ELETTRICO - RISCALDATO - (BRACCIO 22MM) REAR-VIEW MIRROR ELECTRIC - HEATED - (ARM 22mm) COS.PEL. ref. SIMILAR ref. 507.07750 81637306305 / 81637306316 DX-SX RH-LH</p>
	<p>SPECCHIO RETROVISORE GRANDANGOLO - RISCALDATO - (BRACCIO 22mm) REAR-VIEW MIRROR WIDE ANGLE - HEATED - (ARM 22mm) COS.PEL. ref. SIMILAR ref. 507.07900 81637306307 DX-SX RH-LH</p>

<p>AD ESAURIMENTO SCORTE UNTIL OIL-OUT</p> 	<p>VETRO SPECCHIO RISCALDATO - (311x171mm) MIRROR GLASS HEATED - (311x171mm)</p> <p>COS.PEL. ref. SIMILAR ref. 507.30049 81637330049</p> <p style="text-align: right;">DX RH</p>
	<p>CONVOGLIATORE ARIA R.I.M. - GRIGIO AIR CONVEYOR R.I.M. - GREY</p> <p>COS.PEL. ref. SIMILAR ref. 907.00064 81624100064</p> <p style="text-align: right;">DX RH</p> <p>907.00063 81624100063</p> <p style="text-align: right;">SX LH</p>
	<p>COPRI BATTERIE S.M.C. - NERO BATTERY COVER S.M.C. - BLACK</p> <p>COS.PEL. ref. SIMILAR ref. 1007.00058 81418600058</p>
	<p>SUPPORTO SOTTOPARAURTI METALLO - Monta solo sul 407.30071 SUPPORT BRACKET SPOILER METAL - For 407.30071</p> <p>COS.PEL. ref. SIMILAR ref. 1007.00059 81416135035</p>
	<p>MANIGLIA PORTA CON CHIAVE NERO - CON CHIAVE DOOR HANDLE BLACK - WITH KEY</p> <p>COS.PEL. ref. SIMILAR ref. 1707.00599 81971006079 / 81971006098</p> <p style="text-align: right;">DX-SX RH-LH</p>
	<p>VASCHETTA ESPANSIONE EXPANSION TANK</p> <p>COS.PEL. ref. SIMILAR ref. 2107.02080 81061026098 / 81061026099 / 81061026201 / 81061026202 / 81061026218</p>
	<p>VASCHETTA ESPANSIONE EXPANSION TANK</p> <p>COS.PEL. ref. SIMILAR ref. 2107.02081 81061026110 / 81061026112 / 81061026205 / 81061026209</p>
	<p>SERBATOIO OLIO STERZO EXPANSION TANK</p> <p>COS.PEL. ref. SIMILAR ref. 2107.02082 81473016048</p>

 <p>cm 15,5</p>	<p>FANALE POSTERIORE 7 FUNZIONI REAR-LIGHT 7 FUNCTIONS</p> <p>COS.PEL. ref. SIMILAR ref. 006120 81252286028 Relativo connettore 003120 006130 81252286027 Con luce targa / With plate light - conn. 003120</p> <p>TRASPARENTE / LENS 011111 81252296055</p> <p>DX RH SX LH DX-SX RH-LH</p>
 <p>cm 15,2</p>	<p>FANALE POSTERIORE 7 FUNZIONI REAR-LIGHT 7 FUNCTIONS</p> <p>COS.PEL. ref. SIMILAR ref. 1504.10500 81252286028 Relativo connettore 003120 1504.10501 81252286027 Con luce targa / With plate light - conn. 003120</p> <p>TRASPARENTE / LENS 011111 81252296055</p> <p>DX RH SX LH DX-SX RH-LH</p>



<p>AD ESAURIMENTO SCORTE UNTIL STOCK-OUT</p> 	<p>ANGOLO PARAURTI (per F 2000 6X4 - 8X4) METALLO - (LARGHEZZA CABINA 2500mm) CORNER BUMPER (for F 2000 6X4 - 8X4) STEEL - (WIDTH'S CAB 2500mm) COS.PEL. ref. SIMILAR ref. 407.05454 81416105454 DX RH</p> <p>407.05453 81416105453 SX LH</p>
<p>AD ESAURIMENTO SCORTE UNTIL STOCK-OUT</p> 	<p>PARAURTI CENTRALE METALLO - (LARGHEZZA CABINA 2500mm) CENTRAL BUMPER STEEL - (WIDTH'S CAB 2500mm) COS.PEL. ref. SIMILAR ref. 407.05455 81416105376</p>



	<p>GRIGLIA R.T.M. - PRIMER GRILLE R.T.M. - PRIMER</p> <p>COS.PEL. ref. SIMILAR ref. 107.00068 81611100048 / 81611100054 / 81611100063</p>
	<p>GRIGLIA A.B.S. - NERO GRILLE A.B.S. - BLACK</p> <p>COS.PEL. ref. SIMILAR ref. 107.00069 81611505068 / 81611506051</p>
	<p>GRIGLIA CENTRALE A.B.S. - NERO CENTRAL GRILLE A.B.S. - BLACK</p> <p>COS.PEL. ref. SIMILAR ref. 107.00070 81416850043 / 81416850052</p>
 <p>cm 92</p> <p>cm 4,5</p> <p>Verificare le misure - Dimensions to be checked</p>	<p>PROLUNGA PARAFANGO LATERALE CABINA LUNGA S.M.C. - GRIGIO EXTENSION MUDGUARD LONG CAB S.M.C. - GREY</p> <p>COS.PEL. ref. SIMILAR ref. 207.00192 81612100742 DX RH</p> <p>207.00193 81612100743 / 81615100554 / 81615100555 SX LH</p>
 <p>cm 93</p> <p>cm 12</p> <p>Verificare le misure - Dimensions to be checked</p>	<p>PROLUNGA PARAFANGO LAT. CAB. LUNGA ALTO S.M.C. - GRIGIO EXTENSION MUDGUARD LONG CAB HIGH TYPE S.M.C. - GREY</p> <p>COS.PEL. ref. SIMILAR ref. 207.00194 81612100616 / 81615100288 / 81615100346 DX RH</p> <p>207.00195 81612100617 / 81615100552 / 81615100553 / 81615100558 SX LH</p>







TGA LX

 <p>Verificare le misure - Dimensions to be checked</p>	<p>PROLUNGA PARAFANGO LATERALE CABINA CORTA S.M.C. - GRIGIO EXTENSION MUDGUARD SHORT CAB S.M.C. - GREY COS.PEL. ref. SIMILAR ref. 207.00196 81612100726 / 81615100364 DX RH</p> <p>207.00197 81615100363 SX LH</p>
 <p>Verificare le misure - Dimensions to be checked</p>	<p>PROLUNGA PARAFANGO LAT. CAB. CORTA ALTO S.M.C. - GRIGIO EXTENSION MUDGUARD SHORT CAB HIGH TYPE S.M.C. - GREY COS.PEL. ref. SIMILAR ref. 207.00198 81612100602 / 81615100284 DX RH</p> <p>207.00199 81612100603 / 81615100285 SX LH</p>
 <p>cm 8</p>	<p>RIPAROFANGO POSTERIORE S.M.C. - GRIGIO REAR MUDGUARD S.M.C. - GREY COS.PEL. ref. SIMILAR ref. 207.00200 81612100684 / 81664100162 / 81664100363 / 81664100367 DX RH</p> <p>207.00201 81612100683 / 81664100155 / 81664100362 / 81664100366 SX LH</p>
 <p>cm 11</p>	<p>RIPAROFANGO POSTERIORE SPALLA ALTA S.M.C. - GRIGIO REAR MUDGUARD S.M.C. - GREY COS.PEL. ref. SIMILAR ref. 207.00202 81612100674 / 81612100676 / 81664100360 / 81664100364 DX RH</p> <p>207.00203 81612100675 / 81664100181 / 81664100361 / 81664100365 SX LH</p>
 <p>cm 55 cm 30.8 cm 24 cm 24 cm 68</p>	<p>COPERTURA PARASPRUZZI MUDGUARD FLAP COS.PEL. ref. SIMILAR ref. 207.06095 81664100484</p>
 <p>cm 52 cm 91</p>	<p>CALOTTA PARAFANGO POSTERIORE - 520mm REAR MUDGUARD UPPER W/O RUBBERS COS.PEL. ref. SIMILAR ref. 207.06096 81664106612</p>
 <p>cm 24 cm 68 cm 98</p>	<p>CALOTTA PARAFANGO POSTERIORE CON 6 TIRANTI P.P.T. - GRIGIO - (680mm) REAR MUDGUARD WITH 6 MUDGUARD TENSIONERS P.P.T. - GREY - (680mm) COS.PEL. ref. SIMILAR ref. 207.06076 81664100226 / 81664106086 DX-SX RH-LH (207.06086 versione senza i tiranti)</p>
 <p>cm 17 cm 67 cm 98</p>	<p>CALOTTA PARAFANGO POSTERIORE CON 4 TIRANTI 2a serie - P.P.T. - GRIGIO - (690mm) REAR MUDGUARD WITH 4 MUDGUARD TENSIONERS 2nd series - P.P.T. - GREY - (690mm) COS.PEL. ref. SIMILAR ref. 207.06077 81664106606 / 81664400192 DX-SX RH-LH (207.06087 versione senza i tiranti)</p>

 <p>cm 26 cm 65 cm 68</p>	<p>MEZZO PARAFANGO POSTERIORE PARTE ANT. P.P. - GRIGIO - SENZA STAFFE REAR MUDGUARD FRONT PART P.P. - GREY - W/O BRACKETS COS.PEL. ref. SIMILAR ref. 207.06082 81664100294 DX RH</p> <p>207.06083 81664100293 SX LH</p>
 <p>cm 27 cm 64 cm 69</p>	<p>MEZZO PARAFANGO POSTERIORE PARTE POST. P.P. - GRIGIO - SENZA STAFFE REAR MUDGUARD REAR PART P.P. - GREY - W/O BRACKETS COS.PEL. ref. SIMILAR ref. 207.06084 81664100172 DX RH</p> <p>207.06085 81664100173 SX LH</p>
 <p>cm 24 cm 68 cm 98</p>	<p>CALOTTA PARAFANGO POSTERIORE P.P.T. - GRIGIO - (680mm) REAR MUDGUARD P.P.T. - GREY - (680mm) COS.PEL. ref. SIMILAR ref. 207.06086 81664106086 DX-SX RH-LH</p> <p>Relativo tirante 1007.00001 - (207.06076 versione con i tiranti)</p>
 <p>cm 17 cm 67 cm 98</p>	<p>CALOTTA PARAFANGO POSTERIORE 2a serie - P.P.T. - GRIGIO REAR MUDGUARD 2nd series - P.P.T. - GREY COS.PEL. ref. SIMILAR ref. 207.06087 81664106606 DX-SX RH-LH</p> <p>Relativo tirante 1001.14951 - (207.06077 versione con i tiranti)</p>
 <p>cm 68 cm 68</p>	<p>PARAFANGO POSTERIORE REAR WHEEL MUDGUARD COS.PEL. ref. SIMILAR ref. 207.06092 81664100463 DX RH</p> <p>207.06091 81664100462 SX LH</p>
	<p>MEZZO PARAFANGO POSTERIORE PARTE ANTERIORE REAR MUDGUARD FRONT PART COS.PEL. ref. SIMILAR ref. 207.06097 81664106608</p>
 <p>cm 17,7 cm 69 cm 85</p>	<p>CALOTTA PARAFANGO POSTERIORE REAR MUDGUARD COS.PEL. ref. SIMILAR ref. 207.06099 81664106607 DX-SX RH-LH</p> <p>Relativo tirante 1001.14951 - (207.06100 versione con i tiranti)</p>
 <p>cm 17,7 cm 69 cm 85</p>	<p>CALOTTA PARAFANGO POSTERIORE CON 4 TIRANTI REAR MUDGUARD WITH 4 MUDGUARD TENSIONERS COS.PEL. ref. SIMILAR ref. 207.06100 81664106607 / 81664400192 DX-SX RH-LH</p> <p>(207.06099 versione senza i tiranti)</p>

TGA LX

 <p>cm 5</p>	<p>PEDANA PARAFANGO S.M.C. - GRIGIO - MODELLO STRADALE FOOTSTEP MUDGUARD S.M.C. - GREY - ROAD TYPE</p> <p>COS.PEL. ref. SIMILAR ref.</p> <p>307.00300 81615100474 / 81615100476 / 81615100848 / 81615100856 DX RH</p> <p>307.00301 81615100475 / 81615100477 / 81615100847 / 81615100855 SX LH</p> <p>Griglia / grille : 1007.05188 inf. - 1007.05190 sup. Griglia / grille : 1007.05188 inf. - 1007.05190 sup.</p>
 <p>cm 12</p>	<p>PEDANA PARAFANGO ALETTA DOPPIA S.M.C. - GRIGIO - MODELLO STRADALE FOOTSTEP MUDGUARD S.M.C. - GREY - ROAD TYPE</p> <p>COS.PEL. ref. SIMILAR ref.</p> <p>307.00302 81615100470 / 81615100472 / 81615100760 / 81615100763 / 81615100872 DX RH</p> <p>307.00303 81615100471 / 81615100473 / 81615100759 / 81615100871 SX LH</p> <p>Griglia/grille : 1007.05188 inf. - 1007.05190 sup. Griglia/grille : 1007.05188 inf. - 1007.05190 sup.</p>
 <p>cm 29</p> <p>cm 60</p>	<p>VASCHETTA PEDANA (GUIDA A DESTRA) P.P.G.F. - GRIGIO FOOTSTEP (RHD) P.P.G.F. - GREY</p> <p>COS.PEL. ref. SIMILAR ref.</p> <p>307.15202 81615100348 / 81615100644 / 81615100738 / 81615100980 DX RH</p> <p>307.15203 81615100381 / 81615100643 / 81615100737 / 81615100979 SX LH</p> <p>Griglia/Grille: 1007.05187</p>
 <p>cm 29</p> <p>cm 60</p>	<p>VASCHETTA PEDANA P.P.G.F. - GRIGIO FOOTSTEP P.P.G.F. - GREY</p> <p>COS.PEL. ref. SIMILAR ref.</p> <p>307.15200 81615100380 / 81615100736 DX RH</p> <p>307.15201 81615100323 / 81615100351 / 81615100735 SX LH</p> <p>Griglia/Grille : 1007.05187 Griglia/Grille : 1007.05187</p>
	<p>ANGOLO PARAURTI CABINA LX P.P. - GRIGIO CORNER BUMPER CAB LX P.P. - GREY</p> <p>COS.PEL. ref. SIMILAR ref.</p> <p>407.00226 81416100226 DX RH</p> <p>407.00225 81416100225 SX LH</p>
 <p>cm 80</p>	<p>PARAURTI ANTERIORE P.P.G.F. - PRIMER FRONT BUMPER P.P.G.F. - PRIMER</p> <p>COS.PEL. ref. SIMILAR ref.</p> <p>407.00307 81416100307</p>
 <p>cm 80</p>	<p>PARAURTI ANTERIORE P.P.G.F. - GRIGIO FRONT BUMPER P.P.G.F. - GREY</p> <p>COS.PEL. ref. SIMILAR ref.</p> <p>407.00308 81416100308</p>
	<p>TAPPO CENTRALE PARAURTI BUMPER CENTRAL COVER</p> <p>COS.PEL. ref. SIMILAR ref.</p> <p>407.00314 81416850031</p>

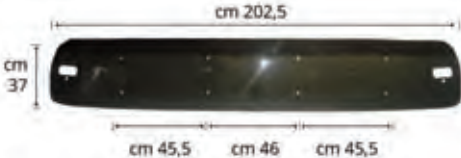
	<p>TAPPO PARAURTI FORO LAVAFARO HEADLAMP WASH HOLE BUMPER COVER RH-LH</p> <p>COS.PEL. ref. 407.00315 SIMILAR ref. 81416850040 DX-SX RH-LH</p>
	<p>PEDANA PARAURTI SUPERIORE UPPER BUMPER STEP</p> <p>COS.PEL. ref. 407.00316 SIMILAR ref. 81416102882</p> <p>Relativo paraurti: 407.00305/6/7/8</p>
	<p>PEDANA PARAURTI INFERIORE LOWER BUMPER STEP</p> <p>COS.PEL. ref. 407.00317 SIMILAR ref. 81416102881</p> <p>Relativo paraurti: 407.00305/6/7/8</p>
	<p>TAPPO PARAURTI BUMPER COVER</p> <p>COS.PEL. ref. 407.00319 SIMILAR ref. 81960020466 / 81960020491 / 81960020497 DX-SX RH-LH</p>
	<p>TERMINALE PARAURTI A.B.S. FRONT TERMINAL SPOILER</p> <p>COS.PEL. ref. 407.00304 SIMILAR ref. 81416100230 / 81416100312 DX RH</p> <p>407.00303 81416100229 / 81416100313 SX LH</p>
	<p>PROTEZIONE TAMPONAMENTO METALLO FRONT REINFORCEMENT METAL</p> <p>COS.PEL. ref. 407.15186 SIMILAR ref. 81416505013</p>
	<p>SPECCHIO FRONTALE FRONT GLASS</p> <p>COS.PEL. ref. 507.25504 SIMILAR ref. 81637306572 / 81637306656 / 81637306660</p>
	<p>VISIERA SUN VISOR</p> <p>COS.PEL. ref. 707.15300 SIMILAR ref. 81637010047</p> <p>Relativo kit staffe 1007.15300</p>

	<p>COPRI BATTERIE BATTERY COVER</p> <p>COS.PEL. ref. 1007.00011 SIMILAR ref. 81418600144</p>
	<p>GRIGLIA PEDANA SALITA INFERIORE METALLO INNER GRILLE FOOTSTEP METAL</p> <p>COS.PEL. ref. 1007.05187 SIMILAR ref. 81615105187 DX-SX RH-LH</p>
	<p>GRIGLIA PEDANA CENTRALE METALLO CENTRAL GRILLE FOOTSTEP METAL</p> <p>COS.PEL. ref. 1007.05188 SIMILAR ref. 81615110001</p>
	<p>GRIGLIA PEDANA SUPERIORE METALLO UPPER FOOTSTEP GRILLE METAL</p> <p>COS.PEL. ref. 1007.05190 SIMILAR ref. 81615100271 / 81615100490</p>
	<p>SUPPORTO PARAFANGO MUDGUARD BRACKET FRONT SECTION</p> <p>COS.PEL. ref. 1007.10100 SIMILAR ref. 81664200234 DX-SX RH-LH</p>
	<p>SUPPORTO PARAFANGO MUDGUARD BRACKET REAR SECTION</p> <p>COS.PEL. ref. 1007.10101 SIMILAR ref. 81664200237 DX-SX RH-LH</p>
	<p>KIT PER SUPPORTO PARAFANGO MUDGUARD BRACKET KIT</p> <p>COS.PEL. ref. 1007.10102 SIMILAR ref. 81664200125</p>
	<p>SOTTO PORTA DOOR EXTENSION</p> <p>COS.PEL. ref. 1407.15002 SIMILAR ref. 81626100020 DX RH 1407.15001 81626100021 SX LH</p>

	 <p>FANALINO LATERALE P21W SIDE LAMP P21W</p> <p>COS.PEL. ref. SIMILAR ref. 1607.00708 81253206115 / 81253206117 DX-SX RH-LH</p>
	 <p>FANALINO LATERALE P21W SIDE LAMP P21W</p> <p>COS.PEL. ref. SIMILAR ref. 1607.00709 81253206116 / 81253206118 DX-SX RH-LH</p>
	 <p>FANALINO LATERALE LED 4 LED SIDE LAMP LED 4 LED</p> <p>COS.PEL. ref. SIMILAR ref. 1607.00710 81252606101 DX-SX RH-LH</p>
	 <p>FANALINO LATERALE P21W SIDE LAMP P21W</p> <p>COS.PEL. ref. SIMILAR ref. 1607.00711 81253206102 DX-SX RH-LH</p>
	 <p>FANALINO LATERALE P21W SIDE LAMP P21W</p> <p>COS.PEL. ref. SIMILAR ref. 1607.00712 81253206100 DX-SX RH-LH</p>
	<p>FANALINO INGOMBRO CABINA TETTO BASSO DRIVER CAB SIDE MARKER LOW CAB</p> <p>COS.PEL. ref. SIMILAR ref. 1607.00713 81252606099 DX-SX RH-LH</p>
	<p>FANALINO INGOMBRO CABINA LED TETTO ALTO DRIVER CAB SIDE MARKER HIGH CAB</p> <p>COS.PEL. ref. SIMILAR ref. 1607.00714 81252606121 DX-SX RH-LH</p>
	<p>MANIGLIA PORTA CON CHIAVE DOOR HANDLE WITH KEY</p> <p>COS.PEL. ref. SIMILAR ref. 1707.00600 81626416080 DX RH</p> <p>1707.00601 81626416081 SX LH</p>

TGA LX

	<p>MANIGLIA PORTA INTERNA INNER DOOR HANDLE</p> <p>COS.PEL. ref. SIMILAR ref. 1707.00602 81626416068 DX RH</p> <p>1707.00603 81626416067 SX LH</p>
	<p>CERNIERA PORTA SUPERIORE UPPER DOOR HINGE</p> <p>COS.PEL. ref. SIMILAR ref. 1707.00606 81626906030 / 81626906048 / 81626906050 / 81626906052 DX RH</p> <p>1707.00607 81616906051 / 81626906031 / 81626906047 / 81626906049 SX LH</p>
	<p>CERNIERA PORTA INFERIORE LOWER DOOR HINGE</p> <p>COS.PEL. ref. SIMILAR ref. 1707.00608 81616906056 / 81626906046 / 81626906054 / 81626906062 / 81626906064 DX RH</p> <p>1707.00609 81626906045 / 81626906055 / 81626906061 / 81626906063 SX LH</p>
	<p>ALZACRISTALLI ELETTRICO - SENZA MOTORINO WINDOW REGULATOR ELECTRIC - WITHOUT MOTOR</p> <p>COS.PEL. ref. SIMILAR ref. 1907.25000 81626456052 DX RH</p> <p>1907.25001 81626456053 SX LH</p>
	<p>SERBATOIO OLIO STERZO EXPANSION TANK</p> <p>COS.PEL. ref. SIMILAR ref. 2107.02082 81473016048</p>
	<p>TIRANTE CALOTTA 3a SERIE GOMMA - NERO MUDGUARD TENSIONER 3rd SERIES RUBBER - BLACK</p> <p>COS.PEL. ref. SIMILAR ref. 1001.14951 81664400192</p>
	<p>MOLLA A GAS Lunghezza [mm] 685 Corsa [mm] 300 Forza scarto [N] 160 GAS SPRING Lenght [mm] 685 Stroke [mm] 300 Waste force [N] 160</p> <p>COS.PEL. ref. SIMILAR ref. 2407.00101 81970060002</p>
	<p>MOLLA A GAS Lunghezza [mm] 685 Corsa [mm] 241 Forza scarto [N] 185 GAS SPRING Lenght [mm] 685 Stroke [mm] 241 Waste force [N] 185</p> <p>COS.PEL. ref. SIMILAR ref. 2407.00102 81970060036</p>

	<p>MOLLA A GAS Lunghezza [mm] 785 Corsa [mm] 340 Forza scarto [N] 150 GAS SPRING Lenght [mm] 785 Stroke [mm] 340 Waste force [N] 150</p> <p>COS.PEL. ref. SIMILAR ref. 2407.00103 81970060003</p>
	<p>DEFLETTORI LATERALI CON CLIPS SIDEWINDOW DEFLECTORS WITH CLIPS</p> <p>COS.PEL. ref. SIMILAR ref. 3007.00000 -</p>
	<p>CICALINO DI RETROMARCIA LC8 destra Cicalino di retromarcia - 24V - 90db BUZZER LC8 right buzzer - 24V - 90db</p> <p>COS.PEL. ref. SIMILAR ref. 003092 -</p>
	<p>KIT PER CONNESSIONI ELETTRICHE Connettore AMP 1,5 singolo KIT FOR ELECTRICAL JOINTS Connector AMP 1,5 simple</p> <p>COS.PEL. ref. SIMILAR ref. 003120 -</p>
	<p>FANALE POSTERIORE CONNETTORE LATERALE AMP 1.5 REAR-LIGHT LATERAL CONNECTOR AMP 1.5</p> <p>COS.PEL. ref. SIMILAR ref. 1507.10000 8125225-6545 DX RH (ex 009214) - Relativo connettore 003120 1507.10001 8125225-6544 SX LH (ex 009215) - Relativo connettore 003120</p> <p>TRASPARENTE / LENS 1507.10100 8125229-6060 (ex 011012) DX RH 1507.10101 8125229-6059 (ex 011011) SX LH</p>
	<p>FANALE POSTERIORE CONNETTORE LATERALE AMP 1.5 REAR-LIGHT LATERAL CONNECTOR AMP 1.5</p> <p>COS.PEL. ref. SIMILAR ref. 1507.10002 8125225-6547 DX RH Con cicalino / With buzzer (ex 009216) - Connettore 003120</p> <p>TRASPARENTE / LENS 1507.10100 8125229-6060 (ex 011012) DX RH</p>



	<p>GRIGLIA A.B.S. - BLACK GRILLE A.B.S. - NERO</p> <p>COS.PEL. ref. SIMILAR ref. 107.00049 81611500110 / 81611505066 / 81611506050</p>
	<p>GRIGLIA CENTRALE FRONT BUMPER CAP</p> <p>COS.PEL. ref. SIMILAR ref. 107.00050 81416850044</p>
	<p>PARAFANGO LATERALE CABINA LARGA S.M.C. - GRIGIO MUDGUARD FOR LARGE CAB S.M.C. - GREY</p> <p>COS.PEL. ref. SIMILAR ref. 207.00408 81615100408 DX RH 207.00409 81615100409 SX LH</p>
	<p>PARAFANGO ANTERIORE PARTE POSTERIORE FRONT MUDGUARD - REAR</p> <p>COS.PEL. ref. SIMILAR ref. 207.06072 81612100462 DX-SX RH-LH</p>
	<p>COPRI PARAFANGO BIANCO LATERALE S.M.C. - PRIMER COVER MUDGUARD WHITE S.M.C. - PRIMER</p> <p>COS.PEL. ref. SIMILAR ref. 207.06078 81664100204 / 81664100308 / 81664100312 DX RH 207.06079 81664100205 / 81664100309 / 81664100313 SX LH</p>

	<p>COPRI PARAFANGO LATERALE S.M.C. - GRIGIO SIDE MUDGUARD COVER S.M.C. - GREY COS.PEL. ref. SIMILAR ref.</p> <p>207.06080 81664100184 / 81664100306 / 81664100310 DX RH</p> <p>207.06081 81664100185 / 81664100307 / 81664100311 SX LH</p>
	<p>COPERTURA PARASPRUZZI MUDGUARD FLAP</p> <p>COS.PEL. ref. SIMILAR ref.</p> <p>207.06095 81664100484</p>
	<p>CALOTTA PARAFANGO POSTERIORE - 520mm REAR MUDGUARD UPPER W/O RUBBERS</p> <p>COS.PEL. ref. SIMILAR ref.</p> <p>207.06096 81664106612</p>
	<p>CALOTTA PARAFANGO POSTERIORE CON 6 TIRANTI P.P.T. - GRIGIO - (680mm) REAR MUDGUARD WITH 6 MUDGUARD TENSIONERS P.P.T. - GREY - (680mm)</p> <p>COS.PEL. ref. SIMILAR ref.</p> <p>207.06076 81664100226 / 81664106086 DX-SX RH-LH (207.06086 versione senza i tiranti)</p>
	<p>CALOTTA PARAFANGO POSTERIORE CON 4 TIRANTI 2a serie - P.P.T. - GRIGIO - (690mm) REAR MUDGUARD WITH 4 MUDGUARD TENSIONERS 2nd series - P.P.T. - GREY - (690mm)</p> <p>COS.PEL. ref. SIMILAR ref.</p> <p>207.06077 81664106606 / 81664400192 DX-SX RH-LH (207.06087 versione senza i tiranti)</p>
	<p>MEZZO PARAFANGO POSTERIORE PARTE ANT. P.P. - GRIGIO - SENZA STAFFE REAR MUDGUARD FRONT PART P.P. - GREY - W/O BRACKETS</p> <p>COS.PEL. ref. SIMILAR ref.</p> <p>207.06082 81664100294 DX RH</p> <p>207.06083 81664100293 SX LH</p>
	<p>MEZZO PARAFANGO POSTERIORE PARTE POST. P.P. - GRIGIO - SENZA STAFFE REAR MUDGUARD REAR PART P.P. - GREY - W/O BRACKETS</p> <p>COS.PEL. ref. SIMILAR ref.</p> <p>207.06084 81664100172 DX RH</p> <p>207.06085 81664100173 SX LH</p>
	<p>CALOTTA PARAFANGO POSTERIORE P.P.T. - GRIGIO - (680mm) REAR MUDGUARD P.P.T. - GREY - (680mm)</p> <p>COS.PEL. ref. SIMILAR ref.</p> <p>207.06086 81664106086 DX-SX RH-LH Relativo tirante 1007.00001 - (207.06076 versione con i tiranti)</p>

	<p>CALOTTA PARAFANGO POSTERIORE 2a serie - P.P.T. - GRIGIO REAR MUDGUARD 2nd series - P.P.T. - GREY</p> <p>COS.PEL. ref. 207.06087 SIMILAR ref. 81664106606 DX-SX RH-LH</p> <p>Relativo tirante 1001.14951 - (207.06077 versione con i tiranti)</p>
	<p>PARAFANGO POSTERIORE REAR WHEEL MUDGUARD</p> <p>COS.PEL. ref. 207.06092 SIMILAR ref. 81664100463 DX RH</p> <p>207.06091 81664100462 SX LH</p>
	<p>MEZZO PARAFANGO POSTERIORE PARTE ANTERIORE REAR MUDGUARD FRONT PART</p> <p>COS.PEL. ref. 207.06097 SIMILAR ref. 81664106608</p>
	<p>TAPPO PARAFANGO MUDGUARD COVER</p> <p>COS.PEL. ref. 207.06098 SIMILAR ref. 81664400187</p>
	<p>CALOTTA PARAFANGO POSTERIORE REAR MUDGUARD</p> <p>COS.PEL. ref. 207.06099 SIMILAR ref. 81664106607 DX-SX RH-LH</p> <p>Relativo tirante 1001.14951 - (207.06100 versione con i tiranti)</p>
	<p>CALOTTA PARAFANGO POSTERIORE CON 4 TIRANTI REAR MUDGUARD WITH 4 MUDGUARD TENSIONERS</p> <p>COS.PEL. ref. 207.06100 SIMILAR ref. 81664106607 / 81664400192 DX-SX RH-LH</p> <p>(207.06099 versione senza i tiranti)</p>
	<p>SPORTELLO PEDANA P.P. - GRIGIO COVER FOOTSTEP P.P. - GREY</p> <p>COS.PEL. ref. 307.00332 SIMILAR ref. 81615100468 / 81615100536 / 81615100822 / 81615100823</p>
	<p>VASCHETTA PEDANA CON TAPPO P.P.G.F. - GRIGIO (GUIDA A DESTRA) FOOTSTEP WITH COVER P.P.G.F. - GREY (RHD)</p> <p>COS.PEL. ref. 307.00334 SIMILAR ref. 81615100800 DX RH</p> <p>Griglia/Grille: 1007.05187</p>

	<p>VASCETTA PEDANA (GUIDA A DESTRA) P.P.G.F. - GRIGIO FOOTSTEP (RHD) P.P.G.F. - GREY</p> <p>COS.PEL. ref. SIMILAR ref. 307.00335 81615100799</p> <p style="text-align: right;">SX LH</p> <p style="text-align: center;">Griglia/Grille: 1007.05187</p>
	<p>VASCETTA PEDANA CON TAPPO (GUIDA A DESTRA) P.P.G.F. - BIANCA FOOTSTEP WITH COVER (RDH) P.P.G.F. - WHITE</p> <p>COS.PEL. ref. SIMILAR ref. 307.00336 81615100804</p> <p style="text-align: right;">DX RH</p> <p style="text-align: center;">Griglia/Grille: 1007.05187</p>
	<p>VASCETTA PEDANA (GUIDA A DESTRA) P.P.G.F. - PRIMER FOOTSTEP (RHD) P.P.G.F. - PRIMER</p> <p>COS.PEL. ref. SIMILAR ref. 307.00337 81615100803</p> <p style="text-align: right;">SX LH</p> <p style="text-align: center;">Griglia/Grille : 1007.05187</p>
	<p>PEDANA CABINA LARGA S.M.C. - GRIGIO FOOTSTEP FOR LARGE CAB S.M.C. - GREY</p> <p>COS.PEL. ref. SIMILAR ref. 307.00400 81615100280 / 81615100400 / 81615100704 / 81615100824</p> <p style="text-align: right;">DX RH</p> <p>307.00411 81615100331 / 81615100401 / 81615100405 / 81615100705 / 81615100827</p> <p style="text-align: right;">SX LH</p> <p style="text-align: center;">Griglia/Grille: 1007.05188 inf - 1007.05189 sup</p>
	<p>PEDANA CABINA LARGA S.M.C. - PRIMER FOOTSTEP FOR LARGE CAB S.M.C. - PRIMER</p> <p>COS.PEL. ref. SIMILAR ref. 307.00402 81615100332 / 81615100402 / 81615100406 / 81615100916</p> <p style="text-align: right;">DX RH</p> <p>307.00401 81615100331 / 81615100401 / 81615100405 / 81615100915</p> <p style="text-align: right;">SX LH</p> <p style="text-align: center;">Griglia/Grille : 1007.05188 inf - 1007.05189 sup</p>
	<p>VASCETTA PEDANA P.P.G.F. - PRIMER FOOTSTEP P.P.G.F. - PRIMER</p> <p>COS.PEL. ref. SIMILAR ref. 307.00338 81615100752</p> <p style="text-align: right;">DX RH</p> <p style="text-align: center;">Griglia/Grille : 1007.05187</p> <p>307.00339 81615100751</p> <p style="text-align: right;">SX LH</p> <p style="text-align: center;">Griglia/Grille : 1007.05187</p>
 <p style="text-align: left;">cm 36</p> <p style="text-align: center;">cm 61</p>	<p>VASCETTA PEDANA P.P.G.F. - GRIGIO FOOTSTEP P.P.G.F. - GREY</p> <p>COS.PEL. ref. SIMILAR ref. 307.00374 81615100312 / 81615100374 / 81615100802</p> <p style="text-align: right;">DX RH</p> <p style="text-align: center;">Griglia/Grille : 1007.05187</p> <p>307.00333 81615100311 / 81615100333 / 81615100801</p> <p style="text-align: right;">SX LH</p> <p style="text-align: center;">Griglia/Grille : 1007.05187</p>
	<p>ANGOLO PARAURTI P.P. - GRIGIO CORNER BUMPER P.P. - GREY</p> <p>COS.PEL. ref. SIMILAR ref. 407.00228 81416100228</p> <p style="text-align: right;">DX RH</p> <p>407.00227 81416100227</p> <p style="text-align: right;">SX LH</p>

	<p>PARAURTI ANTERIORE P.P.G.F. - PRIMER FRONT BUMPER P.P.G.F. - PRIMER</p> <p>COS.PEL. ref. SIMILAR ref. 407.00305 81416100305</p>
	<p>PARAURTI ANTERIORE P.P.G.F. - GRIGIO FRONT BUMPER P.P.G.F. - GREY</p> <p>COS.PEL. ref. SIMILAR ref. 407.00306 81416100306</p>
	<p>TAPPO CENTRALE PARAURTI BUMPER CENTRAL COVER</p> <p>COS.PEL. ref. SIMILAR ref. 407.00314 81416850031</p>
	<p>TAPPO PARAURTI FORO LAVAFARO HEADLAMP WASH HOLE BUMPER COVER RH-LH</p> <p>COS.PEL. ref. SIMILAR ref. 407.00315 81416850040 DX-SX RH-LH</p>
	<p>PEDANA PARAURTI SUPERIORE UPPER BUMPER STEP</p> <p>COS.PEL. ref. SIMILAR ref. 407.00316 81416102882</p> <p>Relativo paraurti: 407.00305/6/7/8</p>
	<p>PEDANA PARAURTI INFERIORE LOWER BUMPER STEP</p> <p>COS.PEL. ref. SIMILAR ref. 407.00317 81416102881</p> <p>Relativo paraurti: 407.00305/6/7/8</p>
	<p>TAPPO PARAURTI BUMPER COVER</p> <p>COS.PEL. ref. SIMILAR ref. 407.00319 81960020466 / 81960020491 / 81960020497 DX-SX RH-LH</p>
	<p>TERMINALE PARAURTI A.B.S. - GRIGIO BUMPER TERMINAL A.B.S. - GREY</p> <p>COS.PEL. ref. SIMILAR ref. 407.00302 81416100232 / 81416100314 DX RH</p> <p>407.00301 81416100231 / 81416100315 SX LH</p>

	<p>PROTEZIONE TAMPONAMENTO METALLO FRONT REINFORCEMENT METAL</p> <p>COS.PEL. ref. SIMILAR ref. 407.15186 81416505013</p>
	<p>SPECCHIO RETROVISORE ELETTRICO - RISCALDATO REAR-VIEW MIRROR ELECTRIC - HEATED</p> <p>COS.PEL. ref. SIMILAR ref. 507.00032 81637306432 DX RH</p> <p>507.00031 81637306430 SX LH</p>
	<p>VETRO SPECCHIO RISCALDATO MIRROR GLASS HEATED</p> <p>COS.PEL. ref. SIMILAR ref. 507.00033 81637336033 / 81637336049 DX-SX RH-LH</p>
	<p>VETRO SPECCHIO GRANDANGOLO - RISCALDATO - RAGGIO 300 MIRROR GLASS WIDE ANGLE - HEATED - RADIUS 300</p> <p>COS.PEL. ref. SIMILAR ref. 507.00034 81637336057 DX-SX RH-LH</p>
	<p>COPERCHIO RETROVISORE A.B.S. COVER MIRROR A.B.S.</p> <p>COS.PEL. ref. SIMILAR ref. 507.00036 81637320060 DX RH</p> <p>507.00035 81637320059 SX LH</p>
	<p>COPERCHIO RETROVISORE GRANDANGOLO A.B.S. COVER MIRROR WIDE ANGLE A.B.S.</p> <p>COS.PEL. ref. SIMILAR ref. 507.00038 81637320062 DX RH</p> <p>507.00037 81637320061 SX LH</p>
<p>AD ESAURIMENTO SCORTE <small>(UNTIL SELL-OUT)</small></p> 	<p>BRACCIO SPECCHIO MIRROR ARM</p> <p>COS.PEL. ref. SIMILAR ref. 507.00040 81637316556 DX RH</p>
	<p>COPRIBRACCIO INFERIORE A.B.S. - GRIGIO LOWER ARM A.B.S. - GREY</p> <p>COS.PEL. ref. SIMILAR ref. 507.00042 81637310260 DX RH</p> <p>507.00041 81637310261 SX LH</p>



SPECCHIO RETROVISORE

ELETTRICO - RISCALDATO

REAR-VIEW MIRROR

ELECTRIC - HEATED

COS.PEL. ref.

SIMILAR ref.

507.15514

81637306513

DX RH

507.15515

81637306512

SX LH



SPECCHIO FRONTALE

FRONT GLASS

COS.PEL. ref.

SIMILAR ref.

507.25504

81637306572 / 81637306656 / 81637306660

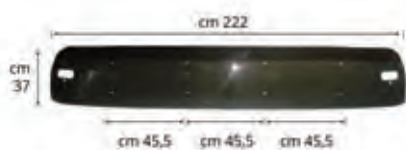

VISIERA TETTO BASSO

TETTO BASSO

SUN VISOR LOW CAB

LOW CAB

COS.PEL. ref.

SIMILAR ref.

707.10200

81637010048

Relativo kit staffe 1007.15300

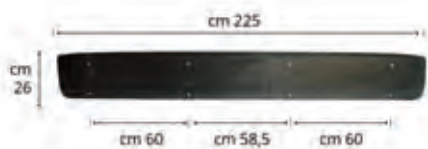

VISIERA TETTO MEDIO

TETTO MEDIO

SUN VISOR MIDDLE CAB

MIDDLE CAB

COS.PEL. ref.

SIMILAR ref.

707.10201

81637010057

Relativo kit staffe 1007.10201

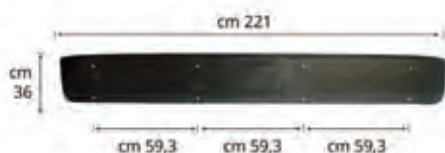

VISIERA TETTO ALTO

TETTO ALTO

SUN VISOR HIGHT CAB

HIGHT CAB

COS.PEL. ref.

SIMILAR ref.

707.10202

81637010044

Relativo kit staffe 1007.10202



CONVOGLIATORE ARIA

R.I.M. - GRIGIO

AIR CONVEYOR

R.I.M. - GREY

COS.PEL. ref.

SIMILAR ref.

907.00048

81624100048

DX RH

907.00049

81624100049

SX LH



CONVOGLIATORE ARIA INTERNO

S.M.C. - BIANCO

INNER AIR CONVEYOR

S.M.C. - WHITE

COS.PEL. ref.

SIMILAR ref.

907.00050

81624100046

DX RH

907.00051

81624100047

SX LH



COPRI BATTERIE

A.B.S. - NERO

BATTERY COVER

A.B.S. - BLACK

COS.PEL. ref.

SIMILAR ref.

1007.00010

81418606090

	<p>COPRI BATTERIE BATTERY COVER</p> <p>COS.PEL. ref. SIMILAR ref. 1007.00011 81418600144</p>
	<p>GRIGLIA PEDANA SALITA INFERIORE METALLO INNER GRILLE FOOTSTEP METAL</p> <p>COS.PEL. ref. SIMILAR ref. 1007.05187 81615105187</p> <p style="text-align: right;">DX-SX RH-LH</p>
	<p>GRIGLIA PEDANA CENTRALE METALLO CENTRAL GRILLE FOOTSTEP METAL</p> <p>COS.PEL. ref. SIMILAR ref. 1007.05188 81615110001</p>
	<p>GRIGLIA PEDANA SUPERIORE METALLO UPPER GRILLE FOR FOOTSTEP METAL</p> <p>COS.PEL. ref. SIMILAR ref. 1007.05189 81615100273</p>
	<p>SUPPORTO PARAFANGO MUDGUARD BRACKET FRONT SECTION</p> <p>COS.PEL. ref. SIMILAR ref. 1007.10100 81664200234</p> <p style="text-align: right;">DX-SX RH-LH</p>
	<p>SUPPORTO PARAFANGO MUDGUARD BRACKET REAR SECTION</p> <p>COS.PEL. ref. SIMILAR ref. 1007.10101 81664200237</p> <p style="text-align: right;">DX-SX RH-LH</p>
	<p>KIT PER SUPPORTO PARAFANGO MUDGUARD BRACKET KIT</p> <p>COS.PEL. ref. SIMILAR ref. 1007.10102 81664200125</p>
	<p>SOTTOPORTA A.B.S. - BIANCO EXTENSION DOOR A.B.S. - WHITE</p> <p>COS.PEL. ref. SIMILAR ref. 1407.00024 81626100024 / 81626100040</p> <p style="text-align: right;">DX RH</p> <p>1407.00023 81626100023 SX LH</p>

 	<p>FANALINO LATERALE P21W SIDE LAMP P21W</p> <p>COS.PEL. ref. SIMILAR ref. 1607.00708 81253206115 / 81253206117 DX-SX RH-LH</p>
 	<p>FANALINO LATERALE P21W SIDE LAMP P21W</p> <p>COS.PEL. ref. SIMILAR ref. 1607.00709 81253206116 / 81253206118 DX-SX RH-LH</p>
 	<p>FANALINO LATERALE LED 4 LED SIDE LAMP LED 4 LED</p> <p>COS.PEL. ref. SIMILAR ref. 1607.00710 81252606101 DX-SX RH-LH</p>
 	<p>FANALINO LATERALE P21W SIDE LAMP P21W</p> <p>COS.PEL. ref. SIMILAR ref. 1607.00711 81253206102 DX-SX RH-LH</p>
 	<p>FANALINO LATERALE P21W SIDE LAMP P21W</p> <p>COS.PEL. ref. SIMILAR ref. 1607.00712 81253206100 DX-SX RH-LH</p>
	<p>FANALINO INGOMBRO CABINA TETTO BASSO DRIVER CAB SIDE MARKER LOW CAB</p> <p>COS.PEL. ref. SIMILAR ref. 1607.00713 81252606099 DX-SX RH-LH</p>
	<p>FANALINO INGOMBRO CABINA LED TETTO ALTO DRIVER CAB SIDE MARKER HIGH CAB</p> <p>COS.PEL. ref. SIMILAR ref. 1607.00714 81252606121 DX-SX RH-LH</p>
	<p>FANALINO INGOMBRO CABINA TETTO BASSO DRIVER CAB SIDE MARKER LED RH-LH LOW CAB</p> <p>COS.PEL. ref. SIMILAR ref. 1607.00717 - DX-SX RH-LH</p>

 	<p>PROIETTORE H7 W5W - CORRETTORE ASSETTO MANUALE HEADLAMP H7 W5W - MANUAL LOAD LEVEL ADJUSTEMENT COS.PEL. ref. SIMILAR ref. 1607.00700 81251016448 DX RH</p> <p>1607.00701 81251016449 SX LH</p>
 	<p>PROIETTORI H7 W5W - PREDISPOSTO PER CORRETTORE ASSETTO HEADLAMP H7 W5W - SUITABLE FOR LOAD LEVEL ADJUSTEMENT COS.PEL. ref. SIMILAR ref. 1607.00702 81251016450 DX RH</p> <p>1607.00703 81251016451 SX LH</p>
 	<p>FENDINEBBIA CON FRECCIA GIALLA H4 P21W FOG LAMP H4 P21W COS.PEL. ref. SIMILAR ref. 1607.00704 81253206092 / 81253206112 DX RH</p> <p>1607.00705 81253206091 / 81253206111 SX LH</p>
 	<p>FENDINEBBIA CON FRECCIA BIANCA H4 P21W FOG LAMP H4 P21W COS.PEL. ref. SIMILAR ref. 1607.00706 81253206114 DX RH</p> <p>1607.00707 81253206113 SX LH</p>
 	<p>FARO SENZA FENDI CON FRECCIA GIALLA P21W - SENZA FENDINEBBIA LAMP P21W - W/O FOG LAMP COS.PEL. ref. SIMILAR ref. 1607.00716 81253206090 DX RH</p> <p>1607.00715 81253206089 SX LH</p>
	<p>MANIGLIA PORTA CON CHIAVE DOOR HANDLE WITH KEY COS.PEL. ref. SIMILAR ref. 1707.00600 81626416080 DX RH</p> <p>1707.00601 81626416081 SX LH</p>
	<p>MANIGLIA PORTA INTERNA INNER DOOR HANDLE COS.PEL. ref. SIMILAR ref. 1707.00602 81626416068 DX RH</p> <p>1707.00603 81626416067 SX LH</p>
	<p>CERNIERA PORTA SUPERIORE UPPER DOOR HINGE COS.PEL. ref. SIMILAR ref. 1707.00606 81626906030 / 81626906048 / 81626906050 / 81626906052 DX RH</p> <p>1707.00607 81616906051 / 81626906031 / 81626906047 / 81626906049 SX LH</p>

	<p>CERNIERA PORTA INFERIORE LOWER DOOR HINGE</p> <p>COS.PEL. ref. SIMILAR ref. 1707.00608 81616906056 / 81626906046 / 81626906054 / 81626906062 / 81626906064 DX RH</p> <p>1707.00609 81626906045 / 81626906055 / 81626906061 / 81626906063 SX LH</p>
	<p>ALZACRISTALLI SENZA MOTORINO WINDOW REGULATOR WITHOUT MOTOR</p> <p>COS.PEL. ref. SIMILAR ref. 1907.20000 81626406056 DX RH</p> <p>1907.20001 81626406055 SX LH</p>
	<p>ALZACRISTALLI ELETTRICO - SENZA MOTORINO WINDOW REGULATOR ELECTRIC - WITHOUT MOTOR</p> <p>COS.PEL. ref. SIMILAR ref. 1907.25000 81626456052 DX RH</p> <p>1907.25001 81626456053 SX LH</p>
	<p>SERBATOIO OLIO STERZO EXPANSION TANK</p> <p>COS.PEL. ref. SIMILAR ref. 2107.02082 81473016048</p>
	<p>TIRANTE CALOTTA 3a SERIE GOMMA - NERO MUDGUARD TENSIONER 3rd SERIES RUBBER - BLACK</p> <p>COS.PEL. ref. SIMILAR ref. 1001.14951 81664400192</p>
	<p>TIRANTE PARAFANGO GOMMA - NERO MUDGUARD TENSIONER RUBBER - BLACK</p> <p>COS.PEL. ref. SIMILAR ref. 1007.00001 81664100226</p>
	<p>MOLLA A GAS Lunghezza [mm] 684 Corsa [mm] 296 Forza scarto [N] 200 GAS SPRING Lenght [mm] 684 Stroke [mm] 296 Waste force [N] 200</p> <p>COS.PEL. ref. SIMILAR ref. 2407.00100 81611400016</p>
	<p>DEFLETTORI LATERALI CON CLIPS SIDOWINDOW DEFLECTORS WITH CLIPS</p> <p>COS.PEL. ref. SIMILAR ref. 3007.00000 -</p>

	<p>GRIGLIA PROTEZIONE FARO Per Cos.Ma Tga / Cos.Re Premium-Kerax / Cos.Da Cf HEADLAMP PROTECTION CAGE For Cos.Ma Tga / Cos.Re Premium-Kerax / Cos.Da Cf</p> <p>COS.PEL. ref. SIMILAR ref. 2000.00016 -</p>
	<p>CICALINO DI RETROMARCIA LC8 destra Cicalino di retromarcia - 24V - 90db BUZZER LC8 right buzzer - 24V - 90db</p> <p>COS.PEL. ref. SIMILAR ref. 003092 -</p>
	<p>KIT PER CONNESSIONI ELETTRICHE Connettore AMP 1,5 singolo KIT FOR ELECTRICAL JOINTS Connector AMP 1,5 simple</p> <p>COS.PEL. ref. SIMILAR ref. 003120 -</p>
	<p>KIT PER CONNESSIONI ELETTRICHE Connettore SUPERSEAL 2 vie femmina KIT FOR ELECTRICAL JOINTS Connector SUPERSEAL ways female</p> <p>COS.PEL. ref. SIMILAR ref. 003123 -</p> <p>Connettore per la serie 1500.xxxxx</p>
	<p>FANALE POSTERIORE LED REAR-LIGHT LED</p> <p>COS.PEL. ref. SIMILAR ref. 006132 - 006133 - TRASPARENTE / LENS Relativo connettore 003120 011112 - Con luce targa / With plate light - conn. 003120</p> <p style="text-align: right;">DX RH SX LH DX-SX RH-LH</p>
	<p>FANALE POSTERIORE LED - 24V - CONNETTORE POSTERIORE AMP 1.5 REAR-LIGHT LED - 24V - REAR CONNECTOR AMP 1.5</p> <p>COS.PEL. ref. SIMILAR ref. 1500.00000 - 1500.00001 - TRASPARENTE / LENS Relativo connettore multipolare 003120</p> <p style="text-align: right;">DX RH SX LH</p>
	<p>FANALE POSTERIORE CONNETTORE LATERALE AMP 1.5 REAR-LIGHT LATERAL CONNECTOR AMP 1.5</p> <p>COS.PEL. ref. SIMILAR ref. 1507.10000 8125225-6545 (ex 009214) - Relativo connettore 003120 1507.10001 8125225-6544 (ex 009215) - Relativo connettore 003120</p> <p>TRASPARENTE / LENS</p> <p>1507.10100 8125229-6060 (ex 011012) DX RH 1507.10101 8125229-6059 (ex 011011) SX LH</p>
	<p>FANALE POSTERIORE CONNETTORE LATERALE AMP 1.5 REAR-LIGHT LATERAL CONNECTOR AMP 1.5</p> <p>COS.PEL. ref. SIMILAR ref. 1507.10002 8125225-6547 Con cicalino / With buzzer (ex 009216) - Connettore 003120</p> <p>TRASPARENTE / LENS</p> <p>1507.10100 8125229-6060 (ex 011012) DX RH</p>



<p>Verificare le misure - Dimensions to be checked</p>	<p>ALETTA PARAFANGO EXTENSION MUDGUARD</p> <p>COS.PEL. ref. 207.00185 SIMILAR ref. 81615100393 / 81615100395</p> <p style="text-align: right;">SX LH</p>
<p>AD ESAURIMENTO SCORTE <small>(INTA. SGLL-4HUF)</small></p> <p>Verificare le misure - Dimensions to be checked</p>	<p>ALETTA PARAFANGO EXTENSION MUDGUARD</p> <p>COS.PEL. ref. 207.00186 SIMILAR ref. 81615100366 / 81615100368</p> <p>207.00187 81615100360 / 81615100389 / 81615100391</p> <p style="text-align: right;">DX RH SX LH</p>
<p>AD ESAURIMENTO SCORTE <small>(INTA. SGLL-4HUF)</small></p> <p>Verificare le misure - Dimensions to be checked</p>	<p>ALETTA PARAFANGO EXTENSION MUDGUARD</p> <p>COS.PEL. ref. 207.00189 SIMILAR ref. 81615100552 / 81615100553</p> <p style="text-align: right;">SX LH</p>
<p>Verificare le misure - Dimensions to be checked</p>	<p>ALETTA PARAFANGO EXTENSION MUDGUARD</p> <p>COS.PEL. ref. 207.00190 SIMILAR ref. 81615100344</p> <p>207.00191 81615100345 / 81615100427 / 81615100429</p> <p style="text-align: right;">DX RH SX LH</p>
	<p>RIPAROFANGO POSTERIORE S.M.C. - GRIGIO REAR MUDGUARD S.M.C. - GREY</p> <p>COS.PEL. ref. 207.00200 SIMILAR ref. 81612100684 / 81664100162 / 81664100363 / 81664100367</p> <p>207.00201 81612100683 / 81664100155 / 81664100362 / 81664100366</p> <p style="text-align: right;">DX RH SX LH</p>

	<p>RIPAROFANGO POSTERIORE SPALLA ALTA S.M.C. - GRIGIO REAR MUDGUARD S.M.C. - GREY COS.PEL. ref. SIMILAR ref.</p> <p>207.00202 81612100674 / 81612100676 / 81664100360 / 81664100364 DX RH</p> <p>207.00203 81612100675 / 81664100181 / 81664100361 / 81664100365 SX LH</p>
	<p>COPERTURA PARASPRUZZI MUDGUARD FLAP</p> <p>COS.PEL. ref. SIMILAR ref.</p> <p>207.06095 81664100484</p>
	<p>CALOTTA PARAFANGO POSTERIORE - 520mm REAR MUDGUARD UPPER W/O RUBBERS</p> <p>COS.PEL. ref. SIMILAR ref.</p> <p>207.06096 81664106612</p>
	<p>PEDANA PARAFANGO S.M.C. - PRIMER FOOTSTEP MUDGUARD S.M.C. - PRIMER COS.PEL. ref. SIMILAR ref.</p> <p>307.00306 81615100474 / 81615100476 DX RH</p> <p>307.00307 81615100475 / 81615100477 SX LH</p> <p>Griglia/Grille : 1007.05188 inf - 1007.05189 sup Griglia/grille : 1007.05188 inf - 1007.05190 sup</p>
	<p>MEZZO PARAFANGO POSTERIORE PARTE ANTERIORE REAR MUDGUARD FRONT PART</p> <p>COS.PEL. ref. SIMILAR ref.</p> <p>207.06097 81664106608</p>
	<p>PEDANA PARAFANGO CON ALETTA S.M.C - GRIGIO - MODELLO CAVA CANTIERE - 6X4 FOOTSTEP MUDGUARD S.M.C. - GREY - TYPE OF ROAD - 6X4 COS.PEL. ref. SIMILAR ref.</p> <p>307.00304 81615100770 / 81615100882 / 81615100936 DX RH</p> <p>307.00305 81615100587 / 81615100771 / 81615100883 SX LH</p> <p>Griglia/grille : 1007.05188 inf - 1007.05190 sup Griglia/grille : 1007.05188 inf - 1007.05190 sup</p>
	<p>PARAURTI CENTRALE METALLO - NERO CENTRAL BUMPER METAL - BLACK</p> <p>COS.PEL. ref. SIMILAR ref.</p> <p>407.00309 81416105451 / 81416105664 / 81416105722</p>
	<p>ANGOLO PARAURTI METALLO - NERO FRONT SIDE BUMPER METAL - BLACK COS.PEL. ref. SIMILAR ref.</p> <p>407.00310 81416105508 / 81416105598 / 81416105600 DX RH</p> <p>407.00311 81416105507 / 81416105597 / 81416105599 SX LH</p>

	<p>TERMINALE PARAURTI A.B.S. - GRIGIO FRONT TERMINAL SPOILER A.B.S. - GREY COS.PEL. ref. SIMILAR ref. 407.00312 81416100376 DX RH</p> <p>407.00313 81416100375 SX LH</p>
	<p>PROTEZIONE TAMPONAMENTO METALLO FRONT REINFORCEMENT METAL COS.PEL. ref. SIMILAR ref. 407.15186 81416505013</p>
	<p>GRIGLIA PEDANA CENTRALE METALLO CENTRAL GRILLE FOOTSTEP METAL COS.PEL. ref. SIMILAR ref. 1007.05188 81615110001</p>
	<p>GRIGLIA PEDANA SUPERIORE METALLO UPPER GRILLE FOR FOOTSTEP METAL COS.PEL. ref. SIMILAR ref. 1007.05189 81615100273</p>
	<p>GRIGLIA PEDANA SUPERIORE METALLO UPPER FOOTSTEP GRILLE METAL COS.PEL. ref. SIMILAR ref. 1007.05190 81615100271 / 81615100490</p>
	<p>SUPPORTO PARAFANGO MUDGUARD BRACKET FRONT SECTION COS.PEL. ref. SIMILAR ref. 1007.10100 81664200234 DX-SX RH-LH</p>
	<p>SUPPORTO PARAFANGO MUDGUARD BRACKET REAR SECTION COS.PEL. ref. SIMILAR ref. 1007.10101 81664200237 DX-SX RH-LH</p>
	<p>KIT PER SUPPORTO PARAFANGO MUDGUARD BRACKET KIT COS.PEL. ref. SIMILAR ref. 1007.10102 81664200125</p>

		<p>FANALINO LATERALE P21W SIDE LAMP P21W</p> <p>COS.PEL. ref. SIMILAR ref. 1607.00708 81253206115 / 81253206117 DX-SX RH-LH</p>
		<p>FANALINO LATERALE P21W SIDE LAMP P21W</p> <p>COS.PEL. ref. SIMILAR ref. 1607.00709 81253206116 / 81253206118 DX-SX RH-LH</p>
		<p>FANALINO LATERALE LED 4 LED SIDE LAMP LED 4 LED</p> <p>COS.PEL. ref. SIMILAR ref. 1607.00710 81252606101 DX-SX RH-LH</p>
		<p>FANALINO LATERALE P21W SIDE LAMP P21W</p> <p>COS.PEL. ref. SIMILAR ref. 1607.00711 81253206102 DX-SX RH-LH</p>
		<p>FANALINO LATERALE P21W SIDE LAMP P21W</p> <p>COS.PEL. ref. SIMILAR ref. 1607.00712 81253206100 DX-SX RH-LH</p>
		<p>FANALINO INGOMBRO CABINA TETTO BASSO DRIVER CAB SIDE MARKER LOW CAB</p> <p>COS.PEL. ref. SIMILAR ref. 1607.00713 81252606099 DX-SX RH-LH</p>
		<p>FANALINO INGOMBRO CABINA LED TETTO ALTO DRIVER CAB SIDE MARKER HIGH CAB</p> <p>COS.PEL. ref. SIMILAR ref. 1607.00714 81252606121 DX-SX RH-LH</p>
		<p>CERNIERA PORTA SUPERIORE UPPER DOOR HINGE</p> <p>COS.PEL. ref. SIMILAR ref. 1707.00606 81626906030 / 81626906048 / 81626906050 / 81626906052 DX RH</p> <p>1707.00607 81616906051 / 81626906031 / 81626906047 / 81626906049 SX LH</p>

TGA/TGS 6X4

	<p>CERNIERA PORTA INFERIORE LOWER DOOR HINGE</p> <p>COS.PEL. ref. SIMILAR ref. 1707.00608 81616906056 / 81626906046 / 81626906054 / 81626906062 / 81626906064 DX RH</p> <p>1707.00609 81626906045 / 81626906055 / 81626906061 / 81626906063 SX LH</p>
	<p>ALZACRISTALLI ELETTRICO - SENZA MOTORINO WINDOW REGULATOR ELECTRIC - WITHOUT MOTOR</p> <p>COS.PEL. ref. SIMILAR ref. 1907.25000 81626456052 DX RH</p> <p>1907.25001 81626456053 SX LH</p>
	<p>DEFLETTORI LATERALI CON CLIPS SIDEWINDOW DEFLECTORS WITH CLIPS</p> <p>COS.PEL. ref. SIMILAR ref. 3007.00000 -</p>



	<p>GRIGLIA FRONTALE S.M.C. FRONT GRILLE S.M.C.</p> <p>COS.PEL. ref. SIMILAR ref. 107.15001 81611100066 / 81611106039 / 81611106042 / 81611106077 / 81611106092 / 81611106101</p>
 <p>Verificare le misure - Dimensions to be checked</p>	<p>PROLUNGA PARAFANGO LATERALE CABINA LUNGA S.M.C. - GRIGIO EXTENSION MUDGUARD LONG CAB S.M.C. - GREY</p> <p>COS.PEL. ref. SIMILAR ref. 207.00192 81612100742 DX RH</p> <p>207.00193 81612100743 / 81615100554 / 81615100555 SX LH</p>
 <p>Verificare le misure - Dimensions to be checked</p>	<p>PROLUNGA PARAFANGO LAT. CAB. LUNGA ALTO S.M.C. - GRIGIO EXTENSION MUDGUARD LONG CAB HIGH TYPE S.M.C. - GREY</p> <p>COS.PEL. ref. SIMILAR ref. 207.00194 81612100616 / 81615100288 / 81615100346 DX RH</p> <p>207.00195 81612100617 / 81615100552 / 81615100553 / 81615100558 SX LH</p>
	<p>CALOTTA PARAFANGO POSTERIORE - 520mm REAR MUDGUARD UPPER W/O RUBBERS</p> <p>COS.PEL. ref. SIMILAR ref. 207.06096 81664106612</p>
	<p>CALOTTA PARAFANGO POSTERIORE CON 6 TIRANTI P.P.T. - GRIGIO - (680mm) REAR MUDGUARD WITH 6 MUDGUARD TENSIONERS P.P.T. - GREY - (680mm)</p> <p>COS.PEL. ref. SIMILAR ref. 207.06076 81664100226 / 81664106086 DX-SX RH-LH</p> <p>(207.06086 versione senza i tiranti)</p>

 <p>cm 67 cm 90 cm 17</p>	<p>CALOTTA PARAFANGO POSTERIORE CON 4 TIRANTI 2a serie - P.P.T. - GRIGIO - (690mm) REAR MUDGUARD WITH 4 MUDGUARD TENSIONERS 2nd series - P.P.T. - GREY - (690mm)</p> <p>COS.PEL. ref. SIMILAR ref. 207.06077 81664106606 / 81664400192 DX-SX RH-LH</p> <p>(207.06087 versione senza i tiranti)</p>
 <p>cm 26 cm 65 cm 66</p>	<p>MEZZO PARAFANGO POSTERIORE PARTE ANT. P.P. - GRIGIO - SENZA STAFFE REAR MUDGUARD FRONT PART P.P. - GREY - W/O BRACKETS</p> <p>COS.PEL. ref. SIMILAR ref. 207.06082 81664100294 DX RH</p> <p>207.06083 81664100293 SX LH</p>
 <p>cm 27 cm 64 cm 69</p>	<p>MEZZO PARAFANGO POSTERIORE PARTE POST. P.P. - GRIGIO - SENZA STAFFE REAR MUDGUARD REAR PART P.P. - GREY - W/O BRACKETS</p> <p>COS.PEL. ref. SIMILAR ref. 207.06084 81664100172 DX RH</p> <p>207.06085 81664100173 SX LH</p>
 <p>cm 24 cm 68 cm 98</p>	<p>CALOTTA PARAFANGO POSTERIORE P.P.T. - GRIGIO - (680mm) REAR MUDGUARD P.P.T. - GREY - (680mm)</p> <p>COS.PEL. ref. SIMILAR ref. 207.06086 81664106086 DX-SX RH-LH</p> <p>Relativo tirante 1007.00001 - (207.06076 versione con i tiranti)</p>
 <p>cm 17 cm 67 cm 90</p>	<p>CALOTTA PARAFANGO POSTERIORE 2a serie - P.P.T. - GRIGIO REAR MUDGUARD 2nd series - P.P.T. - GREY</p> <p>COS.PEL. ref. SIMILAR ref. 207.06087 81664106606 DX-SX RH-LH</p> <p>Relativo tirante 1001.14951 - (207.06077 versione con i tiranti)</p>
	<p>PARAFANGO POSTERIORE PARTE POSTERIORE P.P. REAR WHEEL MUDGUARD - REAR P.P.</p> <p>COS.PEL. ref. SIMILAR ref. 207.06088 81664106625 DX-SX RH-LH</p>
 <p>cm 26,5 cm 69 cm 69</p>	<p>PARAFANGO POSTERIORE PARTE ANTERIORE P.P. REAR WHEEL MUDGUARD - FRONT P.P.</p> <p>COS.PEL. ref. SIMILAR ref. 207.06090 81664106574 DX RH</p> <p>207.06089 81664106573 SX LH</p>
 <p>cm 68 cm 68</p>	<p>PARAFANGO POSTERIORE REAR WHEEL MUDGUARD</p> <p>COS.PEL. ref. SIMILAR ref. 207.06092 81664100463 DX RH</p> <p>207.06091 81664100462 SX LH</p>

	<p>MEZZO PARAFANGO PARTE ANT. MUDGUARD FRONT PART</p> <p>COS.PEL. ref. SIMILAR ref. 207.06093 81664106599 DX-SX RH-LH</p>
	<p>MEZZO PARAFANGO POSTERIORE PARTE ANTERIORE REAR MUDGUARD FRONT PART</p> <p>COS.PEL. ref. SIMILAR ref. 207.06097 81664106608</p>
	<p>CALOTTA PARAFANGO POSTERIORE REAR MUDGUARD</p> <p>COS.PEL. ref. SIMILAR ref. 207.06099 81664106607 DX-SX RH-LH Relativo tirante 1001.14951 - (207.06100 versione con i tiranti)</p>
	<p>CALOTTA PARAFANGO POSTERIORE CON 4 TIRANTI REAR MUDGUARD WITH 4 MUDGUARD TENSIONERS</p> <p>COS.PEL. ref. SIMILAR ref. 207.06100 81664106607 / 81664400192 DX-SX RH-LH (207.06099 versione senza i tiranti)</p>
	<p>PEDANA PARAFANGO ALETTA DOPPIA S.M.C. - GRIGIO - MODELLO STRADALE FOOTSTEP MUDGUARD S.M.C. - GREY - ROAD TYPE</p> <p>COS.PEL. ref. SIMILAR ref. 307.00302 81615100470 / 81615100472 / 81615100760 / 81615100763 / 81615100872 DX RH Griglia/grille : 1007.05188 inf. - 1007.05190 sup. 307.00303 81615100471 / 81615100473 / 81615100759 / 81615100871 SX LH Griglia/grille : 1007.05188 inf. - 1007.05190 sup.</p>
	<p>SPORTELLINO PEDANA P.P. - GRIGIO COVER FOOTSTEP P.P. - GREY</p> <p>COS.PEL. ref. SIMILAR ref. 307.00332 81615100468 / 81615100536 / 81615100822 / 81615100823</p>
	<p>VASCHETTA PEDANA (GUIDA A DESTRA) P.P.G.F. - GRIGIO FOOTSTEP (RHD) P.P.G.F. - GREY</p> <p>COS.PEL. ref. SIMILAR ref. 307.15202 81615100348 / 81615100644 / 81615100738 / 81615100980 DX RH Griglia/Grille: 1007.05187 307.15203 81615100381 / 81615100643 / 81615100737 / 81615100979 SX LH Griglia/Grille: 1007.05187</p>
	<p>VASCHETTA PEDANA P.P.G.F. - GRIGIO FOOTSTEP P.P.G.F. - GREY</p> <p>COS.PEL. ref. SIMILAR ref. 307.15200 81615100380 / 81615100736 DX RH Griglia/Grille : 1007.05187 307.15201 81615100323 / 81615100351 / 81615100735 SX LH Griglia/Grille : 1007.05187</p>

	<p>TAPPO PARAURTI BUMPER COVER</p> <p>COS.PEL. ref. SIMILAR ref. 407.10204 81416850072 / 81416850074 / 81416850114 DX RH</p> <p>407.10203 81416850065 / 81416850072 / 81416850074 SX LH</p>
	<p>PARAURTI ANTERIORE - PREDISPOSTO ACC P.P.G.F. - GRIGIO FRONT BUMPER - FITTED TO ACC P.P.G.F. - GREY</p> <p>COS.PEL. ref. SIMILAR ref. 407.15184 81416100397</p>
	<p>PARAURTI ANTERIORE - PREDISPOSTO ACC P.P.G.F. - PRIMER FRONT BUMPER - FITTED TO ACC P.P.G.F. - PRIMER</p> <p>COS.PEL. ref. SIMILAR ref. 407.15185 81416100399</p>
 <p>cm 85</p>	<p>PARAURTI ANTERIORE P.P.G.F. - PRIMER FRONT BUMPER P.P.G.F. - PRIMER</p> <p>COS.PEL. ref. SIMILAR ref. 407.15189 81416100362 / 81416100409 / 81416100569</p>
 <p>cm 85</p>	<p>PARAURTI ANTERIORE P.P.G.F. - GRIGIO FRONT BUMPER P.P.G.F. - GREY</p> <p>COS.PEL. ref. SIMILAR ref. 407.15190 81416100361 / 81416100408 / 81416100568</p>
	<p>ANGOLO PARAURTI P.P. - GRIGIO CORNER BUMPER P.P. - GREY</p> <p>COS.PEL. ref. SIMILAR ref. 407.15192 81416140024 / 81416140028 DX RH</p> <p>407.15191 81416140023 / 81416140027 SX LH</p>
	<p>CORNICE FARO FENDINEBBIA A.B.S. - NERO FRAME INSIDE A.B.S. - BLACK</p> <p>COS.PEL. ref. SIMILAR ref. 407.15194 81416850094 DX RH</p> <p>407.15193 81416850095 SX LH</p>
	<p>CORNICE FARO FENDINEBBIA A.B.S. - NERO FOG LAMP FRAME A.B.S. - BLACK</p> <p>COS.PEL. ref. SIMILAR ref. 407.15196 81416850098 DX RH</p> <p>407.15195 81416850099 SX LH</p>

	<p>TAPPO PARAURTI BUMPER COVER</p> <p>COS.PEL. ref. SIMILAR ref. 407.15198 81416850130 / 81416850132 DX RH</p> <p>407.15197 81416850129 / 81416850131 SX LH</p>
	<p>SUPPORTO PARAURTI FRONT BUMPER BRACKET</p> <p>COS.PEL. ref. SIMILAR ref. 407.15200 81416146000 DX RH</p> <p>407.15199 81416146001 SX LH</p>
	<p>TAPPO PARAURTI A.B.S. BUMPER COVER A.B.S.</p> <p>COS.PEL. ref. SIMILAR ref. 407.00300 81416850029</p>
	<p>TERMINALE PARAURTI A.B.S. - GRIGIO FRONT TERMINAL SPOILER A.B.S. - GREY</p> <p>COS.PEL. ref. SIMILAR ref. 407.15188 81416100368 DX RH</p> <p>407.15187 81416100367 SX LH</p>
	<p>SPECCHIO RETROVISORE ELETTRICO RISCALDATO - G.A. - MANUALE - BRACCIO LUNGO REAR-VIEW MIRROR ELECTRIC HEATED - W.A. - MANUAL - LONG ARM</p> <p>COS.PEL. ref. SIMILAR ref. 507.15500 81637306534 DX RH</p> <p>507.15501 81637306533 SX LH</p>
	<p>SPECCHIO RETROVISORE ELETTRICO RISCALDATO - G.A. - BRACCIO MEDIO REAR-VIEW MIRROR ELECTRIC HEATED - W.A. - MEDIUM ARM</p> <p>COS.PEL. ref. SIMILAR ref. 507.15502 81637306550 DX RH</p> <p>507.15503 81637306549 SX LH</p>
	<p>VETRO SPECCHIO RISCALDATO MIRROR GLASS HEATED</p> <p>COS.PEL. ref. SIMILAR ref. 507.15504 81637336071 DX-SX RH-LH</p>
	<p>VETRO SPECCHIO RISCALDATO - RAGGIO 300 MIRROR GLASS HEATED - RADIUS 300</p> <p>COS.PEL. ref. SIMILAR ref. 507.15506 81637336072 DX RH</p> <p>507.15505 81637336073 SX LH</p>

	<p>COPERCHIO RETROVISORE COVER MIRROR</p> <p>COS.PEL. ref. 507.15507 SIMILAR ref. 81637310356</p> <p style="text-align: right;">DX-SX RH-LH</p>
	<p>PLASTICA COPRIBRACCIO SUPERIORE UPPER ARM</p> <p>COS.PEL. ref. 507.15508 SIMILAR ref. 81637320074 DX RH</p> <p>507.15509 81637320073 SX LH</p>
	<p>PLASTICA COPRIBRACCIO INFERIORE LOWER ARM</p> <p>COS.PEL. ref. 507.15510 SIMILAR ref. 81637320076 DX RH</p> <p>507.15511 81637320075 SX LH</p>
	<p>SPECCHIO RETROVISORE GUARDA CABINA REAR-VIEW MIRROR</p> <p>COS.PEL. ref. 507.15512 SIMILAR ref. 81637306735 DX RH</p> <p>507.15513 81637306736 SX LH</p>
	<p>CONVOGLIATORE ARIA A.B.S. - BIANCO AIR CONVEYOR A.B.S. - WHITE</p> <p>COS.PEL. ref. 907.10180 SIMILAR ref. 81611100068 DX RH</p> <p>907.10181 81611100067 SX LH</p>
	<p>CONVOGLIATORE ARIA INTERNO A.B.S. - NERO INNER AIR CONVEYOR A.B.S. - BLACK</p> <p>COS.PEL. ref. 907.10182 SIMILAR ref. 81611106032 / 81611106048 DX RH</p> <p>907.10183 81611106033 / 81611106049 SX LH</p>
	<p>COPRI BATTERIE BATTERY COVER</p> <p>COS.PEL. ref. 1007.00011 SIMILAR ref. 81418600144</p>
 <p style="text-align: center;">cm 48</p> <p style="text-align: right;">cm 21,5</p>	<p>GRIGLIA PEDANA SUPERIORE METALLO UPPER FOOTSTEP GRILLE METAL</p> <p>COS.PEL. ref. 1007.05190 SIMILAR ref. 81615100271 / 81615100490</p>

	<p>FANALINO INGOMBRO CABINA TETTO BASSO DRIVER CAB SIDE MARKER LOW CAB</p> <p>COS.PEL. ref. SIMILAR ref. 1607.00713 81252606099</p> <p style="text-align: right;">DX-SX RH-LH</p>
	<p>PROIETTORE MANUALE CON LED PARKING MANUALE - H7*2+PY21W+LED - SENZA DAYTIME - 4+2 Pin HEADLAMP MANUAL WITH LED PARKING MANUAL - H7*2+PY21W+LED - W/O DAYTIME - 4+2 Pin</p> <p>COS.PEL. ref. SIMILAR ref. 1607.10746 81251016658 / 81251016682</p> <p style="text-align: right;">DX RH</p> <p>1607.10747 81251016657 / 81251016681</p> <p style="text-align: right;">SX LH</p>
	<p>PROIETTORE ELETTRICO CON MOTORINO LED P. - DAYTIME - H7*2+PY21W+H21W+LED - 6+3 Pin HEADLAMP WITH MOTOR W. LED P. - W. DAYTIME - H7*2+PY21W+H21W+LED - 6+3 Pin</p> <p>COS.PEL. ref. SIMILAR ref. 1607.10748 81251016504 / 81251016664 / 81251016688</p> <p style="text-align: right;">DX RH</p> <p>1607.10749 81251016503 / 81251016663 / 81251016687</p> <p style="text-align: right;">SX LH</p>
<p>AD ESAURIMENTO SCORTE (UNTIL SELL-OUT)</p> 	<p>PROIETTORE MANUALE SENZA MOTORINO H7*2+PY21W - MANUALE SENZA MOTOR. - LED P. - 6+2 Pin HEADLAMP WITHOUT MOTOR H7*2+PY21W - MANUAL W/O MOTOR - LED P. - 6+2 Pin</p> <p>COS.PEL. ref. SIMILAR ref. 1607.10750 -</p> <p style="text-align: right;">DX RH</p>
	<p>FENDINEBBIA H3 H4 FOG LAMP H3 H4</p> <p>COS.PEL. ref. SIMILAR ref. 1607.10752 81251016522</p> <p style="text-align: right;">DX RH</p> <p>1607.10753 81251016521</p> <p style="text-align: right;">SX LH</p>
	<p>PROIETTORE ELETTRICO CON MOTORINO H7*2+PY21W - ELETTRICO CON MOTOR. - LED P. - 6+2 Pin HEADLAMP WITH MOTOR H7*2+PY21W - ELECTRIC WITH MOTOR - LED P. - 6+2 Pin</p> <p>COS.PEL. ref. SIMILAR ref. 1607.10754 81251016498 / 81251016660 / 81251016684</p> <p style="text-align: right;">DX RH</p> <p>1607.10755 81251016499 / 81251016659 / 81251016683</p> <p style="text-align: right;">SX LH</p>
	<p>MANIGLIA PORTA CON CHIAVE DOOR HANDLE WITH KEY</p> <p>COS.PEL. ref. SIMILAR ref. 1707.00600 81626416080</p> <p style="text-align: right;">DX RH</p> <p>1707.00601 81626416081</p> <p style="text-align: right;">SX LH</p>
	<p>MANIGLIA PORTA INTERNA INNER DOOR HANDLE</p> <p>COS.PEL. ref. SIMILAR ref. 1707.00602 81626416068</p> <p style="text-align: right;">DX RH</p> <p>1707.00603 81626416067</p> <p style="text-align: right;">SX LH</p>

	<p>CERNIERA PORTA SUPERIORE UPPER DOOR HINGE</p> <p>COS.PEL. ref. SIMILAR ref. 1707.00606 81626906030 / 81626906048 / 81626906050 / 81626906052 DX RH</p> <p>1707.00607 81616906051 / 81626906031 / 81626906047 / 81626906049 SX LH</p>
	<p>CERNIERA PORTA INFERIORE LOWER DOOR HINGE</p> <p>COS.PEL. ref. SIMILAR ref. 1707.00608 81616906056 / 81626906046 / 81626906054 / 81626906062 / 81626906064 DX RH</p> <p>1707.00609 81626906045 / 81626906055 / 81626906061 / 81626906063 SX LH</p>
	<p>SERBATOIO OLIO STERZO EXPANSION TANK</p> <p>COS.PEL. ref. SIMILAR ref. 2107.02082 81473016048</p>
	<p>MOLLA A GAS Lunghezza [mm] 685 Corsa [mm] 300 Forza scarto [N] 160 GAS SPRING Lenght [mm] 685 Stroke [mm] 300 Waste force [N] 160</p> <p>COS.PEL. ref. SIMILAR ref. 2407.00101 81970060002</p>
	<p>MOLLA A GAS Lunghezza [mm] 685 Corsa [mm] 241 Forza scarto [N] 185 GAS SPRING Lenght [mm] 685 Stroke [mm] 241 Waste force [N] 185</p> <p>COS.PEL. ref. SIMILAR ref. 2407.00102 81970060036</p>
	<p>MOLLA A GAS Lunghezza [mm] 785 Corsa [mm] 340 Forza scarto [N] 150 GAS SPRING Lenght [mm] 785 Stroke [mm] 340 Waste force [N] 150</p> <p>COS.PEL. ref. SIMILAR ref. 2407.00103 81970060003</p>
	<p>MOLLA A GAS Lunghezza [mm] 785,5 Corsa [mm] 344 Forza scarto [N] 320 GAS SPRING Lenght [mm] 785,5 Stroke [mm] 344 Waste force [N] 320</p> <p>COS.PEL. ref. SIMILAR ref. 2407.12100 81970060029</p>
	<p>MOLLA A GAS Lunghezza [mm] 685 Corsa [mm] 241 Forza scarto [N] 300 GAS SPRING Lenght [mm] 685 Stroke [mm] 241 Waste force [N] 300</p> <p>COS.PEL. ref. SIMILAR ref. 2407.12101 81970060030</p>

	<p>DEFLETTORI LATERALI CON CLIPS SIDEWINDOW DEFLECTORS WITH CLIPS</p> <p>COS.PEL. ref. SIMILAR ref. 3007.00000 -</p>
	<p>KIT PER CONNESSIONI ELETTRICHE Connettore SUPERSEAL 2 vie femmina KIT FOR ELECTRICAL JOINTS Connector SUPERSEAL ways female</p> <p>COS.PEL. ref. SIMILAR ref. 003123 -</p> <p>Connettore per la serie 1500.xxxxx</p>
 <p>15,2 cm</p>	<p>FANALE POSTERIORE LED - 24V - CONNETTORE POSTERIORE AMP 1.5 REAR-LIGHT LED - 24V - REAR CONNECTOR AMP 1.5</p> <p>COS.PEL. ref. SIMILAR ref. 1500.00000 - 1500.00001 - TRASPARENTE / LENS -</p> <p>Relativo connettore multipolare 003120 DX RH Relativo connettore multipolare 003120 SX LH</p>

TGS Euro 6









C.D.S.M.A

	<p>CERNIERA METALLO BRACKET METAL</p> <p>COS.PEL. ref. SIMILAR ref. 107.11102 81611456004</p> <p>107.11103 81611456005</p> <p style="text-align: right;">DX RH SX LH</p>
	<p>GRIGLIA FRONTALE UP+GF30 - BIANCO FRONT GRILLE UP+GF30 - WHITE</p> <p>COS.PEL. ref. SIMILAR ref. 107.12100 81611100109 / 81611106057 / 81611106082 / 81611106096</p>
	<p>GRIGLIA P.P. GRILLE P.P.</p> <p>COS.PEL. ref. SIMILAR ref. 107.12101 81611500138</p>
	<p>PROLUNGA FANALE REAR MUDGUARD REAR COVER</p> <p>COS.PEL. ref. SIMILAR ref. 207.06094 81664400189</p>
	<p>CALOTTA PARAFANGO POSTERIORE - 520mm REAR MUDGUARD UPPER W/O RUBBERS</p> <p>COS.PEL. ref. SIMILAR ref. 207.06096 81664106612</p>

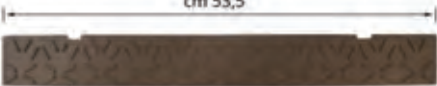
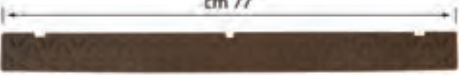
	<p>CALOTTA PARAFANGO POSTERIORE CON 6 TIRANTI P.P.T. - GRIGIO - (680mm) REAR MUDGUARD WITH 6 MUDGUARD TENSIONERS P.P.T. - GREY - (680mm)</p> <p>COS.PEL. ref. SIMILAR ref. 207.06076 81664100226 / 81664106086 DX-SX RH-LH</p> <p>(207.06086 versione senza i tiranti)</p>
	<p>CALOTTA PARAFANGO POSTERIORE CON 4 TIRANTI 2a serie - P.P.T. - GRIGIO - (690mm) REAR MUDGUARD WITH 4 MUDGUARD TENSIONERS 2nd series - P.P.T. - GREY - (690mm)</p> <p>COS.PEL. ref. SIMILAR ref. 207.06077 81664106606 / 81664400192 DX-SX RH-LH</p> <p>(207.06087 versione senza i tiranti)</p>
	<p>MEZZO PARAFANGO POSTERIORE PARTE ANT. P.P. - GRIGIO - SENZA STAFFE REAR MUDGUARD FRONT PART P.P. - GREY - W/O BRACKETS</p> <p>COS.PEL. ref. SIMILAR ref. 207.06082 81664100294 DX RH</p> <p>207.06083 81664100293 SX LH</p>
	<p>MEZZO PARAFANGO POSTERIORE PARTE POST. P.P. - GRIGIO - SENZA STAFFE REAR MUDGUARD REAR PART P.P. - GREY - W/O BRACKETS</p> <p>COS.PEL. ref. SIMILAR ref. 207.06084 81664100172 DX RH</p> <p>207.06085 81664100173 SX LH</p>
	<p>CALOTTA PARAFANGO POSTERIORE P.P.T. - GRIGIO - (680mm) REAR MUDGUARD P.P.T. - GREY - (680mm)</p> <p>COS.PEL. ref. SIMILAR ref. 207.06086 81664106086 DX-SX RH-LH</p> <p>Relativo tirante 1007.00001 - (207.06076 versione con i tiranti)</p>
	<p>CALOTTA PARAFANGO POSTERIORE 2a serie - P.P.T. - GRIGIO REAR MUDGUARD 2nd series - P.P.T. - GREY</p> <p>COS.PEL. ref. SIMILAR ref. 207.06087 81664106606 DX-SX RH-LH</p> <p>Relativo tirante 1001.14951 - (207.06077 versione con i tiranti)</p>
	<p>PARAFANGO POSTERIORE REAR WHEEL MUDGUARD</p> <p>COS.PEL. ref. SIMILAR ref. 207.06092 81664100463 DX RH</p> <p>207.06091 81664100462 SX LH</p>
	<p>MEZZO PARAFANGO PARTE ANT. MUDGUARD FRONT PART</p> <p>COS.PEL. ref. SIMILAR ref. 207.06093 81664106599 DX-SX RH-LH</p>

TGS Euro 6

	<p>MEZZO PARAFANGO POSTERIORE PARTE ANTERIORE REAR MUDGUARD FRONT PART</p> <p>COS.PEL. ref. 207.06097 SIMILAR ref. 81664106608</p>
 <p>cm 69 cm 85 cm 17,7</p>	<p>CALOTTA PARAFANGO POSTERIORE REAR MUDGUARD</p> <p>COS.PEL. ref. 207.06099 SIMILAR ref. 81664106607 DX-SX RH-LH</p> <p>Relativo tirante 1001.14951 - (207.06100 versione con i tiranti)</p>
 <p>cm 69 cm 85 cm 17,7</p>	<p>CALOTTA PARAFANGO POSTERIORE CON 4 TIRANTI REAR MUDGUARD WITH 4 MUDGUARD TENSIONERS</p> <p>COS.PEL. ref. 207.06100 SIMILAR ref. 81664106607 / 81664400192 DX-SX RH-LH</p> <p>(207.06099 versione senza i tiranti)</p>
 <p>cm 5</p>	<p>PEDANA PARAFANGO S.M.C. - GRIGIO - MODELLO STRADALE FOOTSTEP MUDGUARD S.M.C. - GREY - ROAD TYPE</p> <p>COS.PEL. ref. 307.00300 SIMILAR ref. 81615100474 / 81615100476 / 81615100848 / 81615100856 DX RH</p> <p>307.00301 81615100475 / 81615100477 / 81615100847 / 81615100855 SX LH</p> <p>Griglia / grille : 1007.05188 inf. - 1007.05190 sup.</p>
 <p>cm 12</p>	<p>PEDANA PARAFANGO ALETTA DOPPIA S.M.C. - GRIGIO - MODELLO STRADALE FOOTSTEP MUDGUARD S.M.C. - GREY - ROAD TYPE</p> <p>COS.PEL. ref. 307.00302 SIMILAR ref. 81615100470 / 81615100472 / 81615100760 / 81615100763 / 81615100872 DX RH</p> <p>307.00303 81615100471 / 81615100473 / 81615100759 / 81615100871 SX LH</p> <p>Griglia/grille : 1007.05188 inf. - 1007.05190 sup.</p>
	<p>SPORTELLLO PEDANA P.P. - GRIGIO COVER FOOTSTEP P.P. - GREY</p> <p>COS.PEL. ref. 307.00332 SIMILAR ref. 81615100468 / 81615100536 / 81615100822 / 81615100823</p>
 <p>cm 29 cm 60</p>	<p>VASCHETTA PEDANA (GUIDA A DESTRA) P.P.G.F. - GRIGIO FOOTSTEP (RHD) P.P.G.F. - GREY</p> <p>COS.PEL. ref. 307.15202 SIMILAR ref. 81615100348 / 81615100644 / 81615100738 / 81615100980 DX RH</p> <p>307.15203 81615100381 / 81615100643 / 81615100737 / 81615100979 SX LH</p> <p>Griglia/Grille: 1007.05187</p>
 <p>cm 29 cm 60</p>	<p>VASCHETTA PEDANA P.P.G.F. - GRIGIO FOOTSTEP P.P.G.F. - GREY</p> <p>COS.PEL. ref. 307.15200 SIMILAR ref. 81615100380 / 81615100736 DX RH</p> <p>307.15201 81615100323 / 81615100351 / 81615100735 SX LH</p> <p>Griglia/Grille : 1007.05187</p>

 <p>cm 53,5</p>	<p>PEDANA PARAURTI INFERIORE LOWER BUMPER STEP</p> <p>COS.PEL. ref. SIMILAR ref. 407.10193 81416142183</p>
 <p>cm 77</p>	<p>PEDANA PARAURTI SUPERIORE UPPER BUMPER STEP</p> <p>COS.PEL. ref. SIMILAR ref. 407.10194 81416142184</p>
	<p>PROTEZIONE TAMPONAMENTO METALLO FRONT REINFORCEMENT STEEL</p> <p>COS.PEL. ref. SIMILAR ref. 407.10195 81416505010</p>
	<p>CERNIERA TAPPO TERGIFARO PBT+PET+GF20 HINGE PBT+PET+GF20</p> <p>COS.PEL. ref. SIMILAR ref. 407.11098 81416100575 DX RH</p> <p>407.11097 81416100744 SX LH</p>
	<p>COPERCHIO FORO TERGILAVAFARO PP/PE-TD20 - BIANCO HEADLAMP WASH HOLE COVER PP/PE-TD20 - WHITE</p> <p>COS.PEL. ref. SIMILAR ref. 407.11100 81416100532 DX RH</p> <p>407.11099 81416100533 SX LH</p>
 <p>cm 49</p> <p>cm 67</p>	<p>ANGOLO PARAURTI CON COPERCHIO TERGILAVAFARO PP/PE-TD20 - BIANCO CORNER BUMPER WITH HEADLAMP WASH COVER PP/PE-TD20 - WHITE</p> <p>COS.PEL. ref. SIMILAR ref. 407.12080 81416106764 DX RH</p> <p>407.12081 81416106763 SX LH</p>
 <p>cm 46</p> <p>cm 70</p>	<p>ANGOLO PARAURTI PP+LGF20 CORNER BUMPER PP+LGF20</p> <p>COS.PEL. ref. SIMILAR ref. 407.12082 81416106766 DX RH</p> <p>407.12083 81416106765 SX LH</p>
	<p>SPOILER SOTTOPARAURTI PP/PE-TD20 LOWER SPOILER CENTRAL BUMPER PP/PE-TD20</p> <p>COS.PEL. ref. SIMILAR ref. 407.12084 81416140077 / 81416146008</p>

TGS Euro 6

	<p>PEDANA PARAURTI CENTRALE PBT+PET-GF20 CENTRAL BUMPER FOOTSTEP PBT+PET-GF20</p> <p>COS.PEL. ref. SIMILAR ref. 407.12085 81416146006 / 81416146010</p>
	<p>COPERCHIO PARAURTI PET+PC - NERO BUMPER COVER PET+PC - BLACK</p> <p>COS.PEL. ref. SIMILAR ref. 407.12086 81416100560 DX RH</p> <p>407.12087 81416100561 SX LH</p>
	<p>CONVOGLIATORE ARIA PBT+PET-GF20 AIR CONVEYOR PBT+PET-GF20</p> <p>COS.PEL. ref. SIMILAR ref. 407.12088 81416140078 DX RH</p> <p>407.12089 81416140079 SX LH</p>
	<p>PARAURTI PBT+PET-GF20/PET+PC - NERO BUMPER PBT+PET-GF20/PET+PC - BLACK</p> <p>COS.PEL. ref. SIMILAR ref. 407.12090 81416106769</p> <p>Relativi tappi 407.12086/7</p>
	<p>SPECCHIO RETROVISORE ELETTRICO RISCALDATO - G.A. - MANUALE - BRACCIO LUNGO REAR-VIEW MIRROR ELECTRIC HEATED - W.A. - MANUAL - LONG ARM</p> <p>COS.PEL. ref. SIMILAR ref. 507.15500 81637306534 DX RH</p> <p>507.15501 81637306533 SX LH</p>
	<p>SPECCHIO RETROVISORE ELETTRICO RISCALDATO - G.A. - BRACCIO MEDIO REAR-VIEW MIRROR ELECTRIC HEATED - W.A. - MEDIUM ARM</p> <p>COS.PEL. ref. SIMILAR ref. 507.15502 81637306550 DX RH</p> <p>507.15503 81637306549 SX LH</p>
	<p>VETRO SPECCHIO RISCALDATO MIRROR GLASS HEATED</p> <p>COS.PEL. ref. SIMILAR ref. 507.15504 81637336071 DX-SX RH-LH</p>
	<p>VETRO SPECCHIO RISCALDATO - RAGGIO 300 MIRROR GLASS HEATED - RADIUS 300</p> <p>COS.PEL. ref. SIMILAR ref. 507.15506 81637336072 DX RH</p> <p>507.15505 81637336073 SX LH</p>

	<p>COPERCHIO RETROVISORE COVER MIRROR</p> <p>COS.PEL. ref. SIMILAR ref. 507.15507 81637310356</p> <p style="text-align: right;">DX-SX RH-LH</p>
	<p>PLASTICA COPRIBRACCIO SUPERIORE UPPER ARM</p> <p>COS.PEL. ref. SIMILAR ref. 507.15508 81637320074</p> <p style="text-align: right;">DX RH</p> <p>507.15509 81637320073</p> <p style="text-align: right;">SX LH</p>
	<p>PLASTICA COPRIBRACCIO INFERIORE LOWER ARM</p> <p>COS.PEL. ref. SIMILAR ref. 507.15510 81637320076</p> <p style="text-align: right;">DX RH</p> <p>507.15511 81637320075</p> <p style="text-align: right;">SX LH</p>
	<p>DEFLETTORE PBT-ASA+GF30 - BIANCO AIR CONVEYOR PBT-ASA+GF30 - WHITE</p> <p>COS.PEL. ref. SIMILAR ref. 907.11180 81611100088</p> <p style="text-align: right;">DX RH</p> <p>907.11181 81611100089</p> <p style="text-align: right;">SX LH</p>
	<p>DEFLETTORE P.P. - NERO AIR CONVEYOR P.P. - BLACK</p> <p>COS.PEL. ref. SIMILAR ref. 907.11182 81611100122 (81611100090)</p> <p style="text-align: right;">DX RH</p> <p>907.11183 81611100123 (81611100091)</p> <p style="text-align: right;">SX LH</p>
	<p>GRIGLIA PEDANA SUPERIORE METALLO UPPER FOOTSTEP GRILLE METAL</p> <p>COS.PEL. ref. SIMILAR ref. 1007.05190 81615100271 / 81615100490</p>
	<p>SUPPORTO FARO HEADLAMP HOUSING</p> <p>COS.PEL. ref. SIMILAR ref. 1107.11000 81416106760</p> <p style="text-align: right;">DX RH</p> <p>1107.11001 81416106759</p> <p style="text-align: right;">SX LH</p>
	<p>MANIGLIA PORTA CON CHIAVE DOOR HANDLE WITH KEY</p> <p>COS.PEL. ref. SIMILAR ref. 1707.00600 81626416080</p> <p style="text-align: right;">DX RH</p> <p>1707.00601 81626416081</p> <p style="text-align: right;">SX LH</p>

TGS Euro 6

	<p>MANIGLIA PORTA INTERNA INNER DOOR HANDLE</p> <p>COS.PEL. ref. SIMILAR ref. 1707.00602 81626416068 DX RH</p> <p>1707.00603 81626416067 SX LH</p>
	<p>SERRATURA PORTA DOOR LOCK</p> <p>COS.PEL. ref. SIMILAR ref. 1707.00604 81626806142 DX RH</p> <p>1707.00605 81626806143 SX LH</p>
	<p>CERNIERA PORTA SUPERIORE UPPER DOOR HINGE</p> <p>COS.PEL. ref. SIMILAR ref. 1707.00606 81626906030 / 81626906048 / DX RH 81626906050 / 81626906052</p> <p>1707.00607 81616906051 / 81626906031 / SX LH 81626906047 / 81626906049</p>
	<p>CERNIERA PORTA INFERIORE LOWER DOOR HINGE</p> <p>COS.PEL. ref. SIMILAR ref. 1707.00608 81616906056 / 81626906046 / 81626906054 / 81626906062 DX RH / 81626906064</p> <p>1707.00609 81626906045 / 81626906055 / SX LH 81626906061 / 81626906063</p>



 <p>cm 52 cm 91 cm 9</p>	<p>CALOTTA PARAFANGO POSTERIORE - 520mm REAR MUDGUARD UPPER W/O RUBBERS</p> <p>COS.PEL. ref. SIMILAR ref. 207.06096 81664106612</p>
 <p>cm 24 cm 68 cm 98</p>	<p>CALOTTA PARAFANGO POSTERIORE CON 6 TIRANTI P.P.T. - GRIGIO - (680mm) REAR MUDGUARD WITH 6 MUDGUARD TENSIONERS P.P.T. - GREY - (680mm)</p> <p>COS.PEL. ref. SIMILAR ref. 207.06076 81664100226 / 81664106086 DX-SX RH-LH</p> <p>(207.06086 versione senza i tiranti)</p>
 <p>cm 17 cm 67 cm 98</p>	<p>CALOTTA PARAFANGO POSTERIORE CON 4 TIRANTI 2a serie - P.P.T. - GRIGIO - (690mm) REAR MUDGUARD WITH 4 MUDGUARD TENSIONERS 2nd series - P.P.T. - GREY - (690mm)</p> <p>COS.PEL. ref. SIMILAR ref. 207.06077 81664106606 / 81664400192 DX-SX RH-LH</p> <p>(207.06087 versione senza i tiranti)</p>
 <p>cm 26 cm 65 cm 65</p>	<p>MEZZO PARAFANGO POSTERIORE PARTE ANT. P.P. - GRIGIO - SENZA STAFFE REAR MUDGUARD FRONT PART P.P. - GREY - W/O BRACKETS</p> <p>COS.PEL. ref. SIMILAR ref. 207.06082 81664100294 DX RH</p> <p>207.06083 81664100293 SX LH</p>
 <p>cm 27 cm 64 cm 65</p>	<p>MEZZO PARAFANGO POSTERIORE PARTE POST. P.P. - GRIGIO - SENZA STAFFE REAR MUDGUARD REAR PART P.P. - GREY - W/O BRACKETS</p> <p>COS.PEL. ref. SIMILAR ref. 207.06084 81664100172 DX RH</p> <p>207.06085 81664100173 SX LH</p>

ALL ITEMS MENTIONED IN OUR CATALOGUE ARE NOT ORIGINAL PARTS BUT PERFECTLY INTERCHANGEABLE WITH THEM.

GOVERNING LEGISLATIONS FOR THE SALE OF OUR PRODUCTS DIFFER IN EACH COUNTRY.

INFRINGEMENTS, IF ANY, OF LOCAL LEGISLATIONS ARE RESPONSIBILITY OF THE RETAILER IN THE COUNTRY OF FINAL DISTRIBUTION.



	<p>CALOTTA PARAFANGO POSTERIORE P.P.T. - GRIGIO - (680mm) REAR MUDGUARD P.P.T. - GREY - (680mm)</p> <p>COS.PEL. ref. 207.06086 SIMILAR ref. 81664106086 DX-SX RH-LH</p> <p>Relativo tirante 1007.00001 - (207.06076 versione con i tiranti)</p>
	<p>CALOTTA PARAFANGO POSTERIORE 2a serie - P.P.T. - GRIGIO REAR MUDGUARD 2nd series - P.P.T. - GREY</p> <p>COS.PEL. ref. 207.06087 SIMILAR ref. 81664106606 DX-SX RH-LH</p> <p>Relativo tirante 1001.14951 - (207.06077 versione con i tiranti)</p>
	<p>PARAFANGO POSTERIORE PARTE POSTERIORE P.P. REAR WHEEL MUDGUARD - REAR P.P.</p> <p>COS.PEL. ref. 207.06088 SIMILAR ref. 81664106625 DX-SX RH-LH</p>
	<p>PARAFANGO POSTERIORE PARTE ANTERIORE P.P. REAR WHEEL MUDGUARD - FRONT P.P.</p> <p>COS.PEL. ref. 207.06090 SIMILAR ref. 81664106574 DX RH</p> <p>207.06089 81664106573 SX LH</p>
	<p>PARAFANGO POSTERIORE REAR WHEEL MUDGUARD</p> <p>COS.PEL. ref. 207.06092 SIMILAR ref. 81664100463 DX RH</p> <p>207.06091 81664100462 SX LH</p>
	<p>MEZZO PARAFANGO PARTE ANT. MUDGUARD FRONT PART</p> <p>COS.PEL. ref. 207.06093 SIMILAR ref. 81664106599 DX-SX RH-LH</p>
	<p>MEZZO PARAFANGO POSTERIORE PARTE ANTERIORE REAR MUDGUARD FRONT PART</p> <p>COS.PEL. ref. 207.06097 SIMILAR ref. 81664106608</p>
	<p>CALOTTA PARAFANGO POSTERIORE REAR MUDGUARD</p> <p>COS.PEL. ref. 207.06099 SIMILAR ref. 81664106607 DX-SX RH-LH</p> <p>Relativo tirante 1001.14951 - (207.06100 versione con i tiranti)</p>

	<p>CALOTTA PARAFANGO POSTERIORE CON 4 TIRANTI REAR MUDGUARD WITH 4 MUDGUARD TENSIONERS</p> <p>COS.PEL. ref. 207.06100 SIMILAR ref. 81664106607 / 81664400192 DX-SX RH-LH</p> <p>(207.06099 versione senza i tiranti)</p>
	<p>SPORTELLINO PEDANA P.P. - GRIGIO COVER FOOTSTEP P.P. - GREY</p> <p>COS.PEL. ref. 307.00332 SIMILAR ref. 81615100468 / 81615100536 / 81615100822 / 81615100823</p>
	<p>VASCHETTA PEDANA CON TAPPO P.P.G.F. - GRIGIO (GUIDA A DESTRA) FOOTSTEP WITH COVER P.P.G.F. - GREY (RHD)</p> <p>COS.PEL. ref. 307.00334 SIMILAR ref. 81615100800 DX RH</p> <p>Griglia/Grille: 1007.05187</p>
	<p>VASCHETTA PEDANA (GUIDA A DESTRA) P.P.G.F. - GRIGIO FOOTSTEP (RHD) P.P.G.F. - GREY</p> <p>COS.PEL. ref. 307.00335 SIMILAR ref. 81615100799 SX LH</p> <p>Griglia/Grille: 1007.05187</p>
	<p>VASCHETTA PEDANA CON TAPPO (GUIDA A DESTRA) P.P.G.F. - BIANCA FOOTSTEP WITH COVER (RDH) P.P.G.F. - WHITE</p> <p>COS.PEL. ref. 307.00336 SIMILAR ref. 81615100804 DX RH</p> <p>Griglia/Grille: 1007.05187</p>
	<p>VASCHETTA PEDANA (GUIDA A DESTRA) P.P.G.F. - PRIMER FOOTSTEP (RHD) P.P.G.F. - PRIMER</p> <p>COS.PEL. ref. 307.00337 SIMILAR ref. 81615100803 SX LH</p> <p>Griglia/Grille : 1007.05187</p>
	<p>PEDANA CABINA LARGA S.M.C. - GRIGIO FOOTSTEP FOR LARGE CAB S.M.C. - GREY</p> <p>COS.PEL. ref. 307.00400 SIMILAR ref. 81615100280 / 81615100400 / 81615100704 / 81615100824 DX RH</p> <p>307.00411 81615100331 / 81615100401 / 81615100405 / 81615100705 / 81615100827 SX LH</p> <p>Griglia/Grille: 1007.05188 inf - 1007.05189 sup</p>
	<p>PEDANA CABINA LARGA S.M.C. - PRIMER FOOTSTEP FOR LARGE CAB S.M.C. - PRIMER</p> <p>COS.PEL. ref. 307.00402 SIMILAR ref. 81615100332 / 81615100402 / 81615100406 / 81615100916 DX RH</p> <p>307.00401 81615100331 / 81615100401 / 81615100405 / 81615100915 SX LH</p> <p>Griglia/Grille : 1007.05188 inf - 1007.05189 sup</p>



	<p>VASCETTA PEDANA P.P.G.F. - PRIMER FOOTSTEP P.P.G.F. - PRIMER COS.PEL. ref. SIMILAR ref. 307.00338 81615100752 DX RH</p> <p>307.00339 Griglia/Grille : 1007.05187 81615100751 SX LH</p> <p>Griglia/Grille : 1007.05187</p>
	<p>VASCETTA PEDANA P.P.G.F. - GRIGIO FOOTSTEP P.P.G.F. - GREY COS.PEL. ref. SIMILAR ref. 307.00374 81615100312 / 81615100374 / DX RH 81615100802</p> <p>307.00333 Griglia/Grille : 1007.05187 81615100311 / 81615100333 / SX LH 81615100801</p> <p>Griglia/Grille : 1007.05187</p>
	<p>PARAURTI ANTERIORE PREDISPOSTO ACC P.P.G.F. - PRIMER FRONT BUMPER FITTED TO ACC P.P.G.F. - PRIMER COS.PEL. ref. SIMILAR ref. 407.10185 81416100402</p>
	<p>PARAURTI ANTERIORE P.P.G.F. - PRIMER FRONT BUMPER P.P.G.F. - PRIMER COS.PEL. ref. SIMILAR ref. 407.10189 81416100364</p>
	<p>PARAURTI ANTERIORE P.P.G.F. - GRIGIO FRONT BUMPER P.P.G.F. - GREY COS.PEL. ref. SIMILAR ref. 407.10190 81416100363</p>
	<p>ANGOLO PARAURTI P.P. - GRIGIO CORNER BUMPER P.P. - GREY COS.PEL. ref. SIMILAR ref. 407.10192 81416140026 DX RH</p> <p>407.10191 81416140025 SX LH</p>
	<p>PEDANA PARAURTI INFERIORE LOWER BUMPER STEP COS.PEL. ref. SIMILAR ref. 407.10193 81416142183</p>
	<p>PEDANA PARAURTI SUPERIORE UPPER BUMPER STEP COS.PEL. ref. SIMILAR ref. 407.10194 81416142184</p>

	<p>TAPPO PARAURTI FRONT BUMPER GRILLE</p> <p>COS.PEL. ref. SIMILAR ref. 407.10196 81416850134 / 81416850136 DX RH</p> <p>407.10197 81416850133 / 81416850135 SX LH</p>
	<p>CORNICE SU PARAURTI BUMPER RIM</p> <p>COS.PEL. ref. SIMILAR ref. 407.10198 81416144000</p>
	<p>SUPPORTO PARAURTI FRONT BUMPER BRACKET</p> <p>COS.PEL. ref. SIMILAR ref. 407.10200 81416146004 DX RH</p> <p>407.10199 81416146003 SX LH</p>
	<p>TAPPO PARAURTI TERGIFARO Tappo per 407.10190 FRONT BUMPER CAP Cover for 407.10190</p> <p>COS.PEL. ref. SIMILAR ref. 407.10202 81416850072 / 81416850074 DX RH</p> <p>407.10201 81416850071 / 81416850073 SX LH</p>
	<p>TAPPO PARAURTI BUMPER COVER</p> <p>COS.PEL. ref. SIMILAR ref. 407.10204 81416850072 / 81416850074 / DX RH 81416850114</p> <p>407.10203 81416850065 / 81416850072 / SX LH 81416850074</p>
	<p>TERMINALE PARAURTI A.B.S. - GRIGIO FRONT TERMINAL SPOILER A.B.S. - GREY</p> <p>COS.PEL. ref. SIMILAR ref. 407.10188 81416100370 DX RH</p> <p>407.10187 81416100369 SX LH</p>
	<p>SPECCHIO RETROVISORE ELETTRICO RISCALDATO - G.A. - RISCALDATO MANUALE REAR-VIEW MIRROR ELECTRIC HEATED - W.A. - HEATED MANUAL</p> <p>COS.PEL. ref. SIMILAR ref. 507.10500 81637306531 DX RH</p> <p>507.10501 81637306529 SX LH</p>
	<p>SPECCHIO RETROVISORE ELETTRICO RISCALDATO - G.A. - RISCALDATO ELETTRICO REAR-VIEW MIRROR ELECTRIC HEATED - W.A. - HEATED ELECTRIC</p> <p>COS.PEL. ref. SIMILAR ref. 507.10502 81637306561 DX RH</p> <p>507.10503 81637306560 DX RH</p>

	<p>VISIERA TETTO BASSO TETTO BASSO SUN VISOR LOW CAB LOW CAB</p> <p>COS.PEL. ref. 707.10200 SIMILAR ref. 81637010048</p> <p>Relativo kit staffe 1007.15300</p>
	<p>VISIERA TETTO MEDIO TETTO MEDIO SUN VISOR MIDDLE CAB MIDDLE CAB</p> <p>COS.PEL. ref. 707.10201 SIMILAR ref. 81637010057</p> <p>Relativo kit staffe 1007.10201</p>
	<p>VISIERA TETTO ALTO TETTO ALTO SUN VISOR HIGHT CAB HIGHT CAB</p> <p>COS.PEL. ref. 707.10202 SIMILAR ref. 81637010044</p> <p>Relativo kit staffe 1007.10202</p>
	<p>CONVOGLIATORE ARIA A.B.S. - BIANCO AIR CONVEYOR A.B.S. - WHITE</p> <p>COS.PEL. ref. 907.10180 SIMILAR ref. 81611100068 DX RH</p> <p>907.10181 81611100067 SX LH</p>
	<p>CONVOGLIATORE ARIA INTERNO A.B.S. - NERO INNER AIR CONVEYOR A.B.S. - BLACK</p> <p>COS.PEL. ref. 907.10182 SIMILAR ref. 81611106032 / 81611106048 DX RH</p> <p>907.10183 81611106033 / 81611106049 SX LH</p>
	<p>COPRI BATTERIE BATTERY COVER</p> <p>COS.PEL. ref. 1007.00011 SIMILAR ref. 81418600144</p>
	<p>GRIGLIA PEDANA SALITA INFERIORE METALLO INNER GRILLE FOOTSTEP METAL</p> <p>COS.PEL. ref. 1007.05187 SIMILAR ref. 81615105187 DX-SX RH-LH</p>
	<p>GRIGLIA PEDANA CENTRALE METALLO CENTRAL GRILLE FOOTSTEP METAL</p> <p>COS.PEL. ref. 1007.05188 SIMILAR ref. 81615110001</p>

 <p>cm 49,5</p> <p>cm 18</p>	<p>GRIGLIA PEDANA SUPERIORE METALLO UPPER GRILLE FOR FOOTSTEP METAL</p> <p>COS.PEL. ref. SIMILAR ref. 1007.05189 81615100273</p>
	<p>SOTTOPORTA A.B.S. - BIANCO EXTENSION DOOR A.B.S. - WHITE</p> <p>COS.PEL. ref. SIMILAR ref. 1407.00024 81626100024 / 81626100040 DX RH</p> <p>1407.00023 81626100023 SX LH</p>
	<p>FANALINO INGOMBRO CABINA LED TETTO ALTO DRIVER CAB SIDE MARKER HIGH CAB</p> <p>COS.PEL. ref. SIMILAR ref. 1607.00714 81252606121 DX-SX RH-LH</p>
 	<p>PROIETTORE MANUALE CON LED PARKING MANUALE - H7*2+PY21W+LED - SENZA DAYTIME - 4+2 Pin HEADLAMP MANUAL WITH LED PARKING MANUAL - H7*2+PY21W+LED - W/O DAYTIME - 4+2 Pin</p> <p>COS.PEL. ref. SIMILAR ref. 1607.10746 81251016658 / 81251016682 DX RH</p> <p>1607.10747 81251016657 / 81251016681 SX LH</p>
 	<p>PROIETTORE ELETTRICO CON MOTORINO LED P. - DAYTIME - H7*2+PY21W+H21W+LED - 6+3 Pin HEADLAMP WITH MOTOR W. LED P. - W. DAYTIME - H7*2+PY21W+H21W+LED - 6+3 Pin</p> <p>COS.PEL. ref. SIMILAR ref. 1607.10748 81251016504 / 81251016664 / 81251016688 DX RH</p> <p>1607.10749 81251016503 / 81251016663 / 81251016687 SX LH</p>
<p>AD ESAURIMENTO SCORTE UNTIL SPILL-OUT</p>  	<p>PROIETTORE MANUALE SENZA MOTORINO H7*2+PY21W - MANUALE SENZA MOTOR. - LED P. - 6+2 Pin HEADLAMP WITHOUT MOTOR H7*2+PY21W - MANUAL W/O MOTOR - LED P. - 6+2 Pin</p> <p>COS.PEL. ref. SIMILAR ref. 1607.10750 - DX RH</p>
 	<p>FENDINEBBIA H3 H4 FOG LAMP H3 H4</p> <p>COS.PEL. ref. SIMILAR ref. 1607.10752 81251016522 DX RH</p> <p>1607.10753 81251016521 SX LH</p>
 	<p>PROIETTORE ELETTRICO CON MOTORINO H7*2+PY21W - ELETTRICO CON MOTOR. - LED P. - 6+2 Pin HEADLAMP WITH MOTOR H7*2+PY21W - ELECTRIC WITH MOTOR - LED P. - 6+2 Pin</p> <p>COS.PEL. ref. SIMILAR ref. 1607.10754 81251016498 / 81251016660 / 81251016684 DX RH</p> <p>1607.10755 81251016499 / 81251016659 / 81251016683 SX LH</p>

	<p>CERNIERA PORTA SUPERIORE UPPER DOOR HINGE</p> <p>COS.PEL. ref. 1707.00606 SIMILAR ref. 81626906030 / 81626906048 / 81626906050 / 81626906052</p> <p style="text-align: right;">DX RH</p>
	<p>SERBATOIO OLIO STERZO EXPANSION TANK</p> <p>COS.PEL. ref. 2107.02082 SIMILAR ref. 81473016048</p>
	<p>TIRANTE CALOTTA 3a SERIE GOMMA - NERO MUDGUARD TENSIONER 3rd SERIES RUBBER - BLACK</p> <p>COS.PEL. ref. 1001.14951 SIMILAR ref. 81664400192</p>
	<p>MOLLA A GAS Lunghezza [mm] 735 Corsa [mm] 291 Forza scarto [N] 350 GAS SPRING Lenght [mm] 735 Stroke [mm] 291 Waste force [N] 350</p> <p>COS.PEL. ref. 2407.11100 SIMILAR ref. 81970060027</p>
	<p>MOLLA A GAS Lunghezza [mm] 685 Corsa [mm] 241 Forza scarto [N] 330 GAS SPRING Lenght [mm] 685 Stroke [mm] 241 Waste force [N] 330</p> <p>COS.PEL. ref. 2407.11101 SIMILAR ref. 81970060028</p>
	<p>DEFLETTORI LATERALI CON CLIPS SIDEWINDOW DEFLECTORS WITH CLIPS</p> <p>COS.PEL. ref. 3007.00000 SIMILAR ref. -</p>
	<p>CICALINO DI RETROMARCIA LC8 destra Cicalino di retromarcia - 24V - 90db BUZZER LC8 right buzzer - 24V - 90db</p> <p>COS.PEL. ref. 003092 SIMILAR ref. -</p>
	<p>KIT PER CONNESSIONI ELETTRICHE Connettore AMP 1,5 singolo KIT FOR ELECTRICAL JOINTS Connector AMP 1,5 simple</p> <p>COS.PEL. ref. 003120 SIMILAR ref. -</p>

	<p>FANALE POSTERIORE REAR-LIGHT CONNETTORE LATERALE AMP 1.5 LATERAL CONNECTOR AMP 1.5</p> <p>COS.PEL. ref. 1507.10000 SIMILAR ref. 8125225-6545 (ex 009214) - Relativo connettore 003120</p> <p>1507.10001 8125225-6544 (ex 009215) - Relativo connettore 003120</p> <p>TRASPARENTE / LENS</p> <p>1507.10100 8125229-6060 (ex 011012) DX RH</p> <p>1507.10101 8125229-6059 (ex 011011) SX LH</p>
	<p>FANALE POSTERIORE REAR-LIGHT CONNETTORE LATERALE AMP 1.5 LATERAL CONNECTOR AMP 1.5</p> <p>COS.PEL. ref. 1507.10002 SIMILAR ref. 8125225-6547 DX RH Con cicalino / With buzzer (ex 009216) - Connettore 003120</p> <p>TRASPARENTE / LENS</p> <p>1507.10100 8125229-6060 (ex 011012) DX RH</p>

TGX Euro 6



	<p>GRIGLIA UP+GF30 - BIANCO GRILLE UP+GF30 - WHITE</p> <p>COS.PEL. ref. SIMILAR ref. 107.11100 81611106058 / 81611106081 / 81611106095</p>
	<p>CERNIERA METALLO BRACKET METAL</p> <p>COS.PEL. ref. SIMILAR ref. 107.11102 81611456004 DX RH</p> <p>107.11103 81611456005 SX LH</p>
	<p>GRIGLIA P.P. GRILLE P.P.</p> <p>COS.PEL. ref. SIMILAR ref. 107.12101 81611500138</p>
	<p>PARAFANGO ANTERIORE PARTE POSTERIORE FRONT MUDGUARD - REAR</p> <p>COS.PEL. ref. SIMILAR ref. 207.06072 81612100462 DX-SX RH-LH</p>
	<p>PROLUNGA FANALE REAR MUDGUARD REAR COVER</p> <p>COS.PEL. ref. SIMILAR ref. 207.06094 81664400189</p>

 <p>cm 59 cm 91 cm 9</p>	<p>CALOTTA PARAFANGO POSTERIORE - 520mm REAR MUDGUARD UPPER W/O RUBBERS</p> <p>COS.PEL. ref. SIMILAR ref. 207.06096 81664106612</p>
 <p>cm 24 cm 68 cm 98</p>	<p>CALOTTA PARAFANGO POSTERIORE CON 6 TIRANTI P.P.T. - GRIGIO - (680mm) REAR MUDGUARD WITH 6 MUDGUARD TENSIONERS P.P.T. - GREY - (680mm)</p> <p>COS.PEL. ref. SIMILAR ref. 207.06076 81664100226 / 81664106086 DX-SX RH-LH</p> <p>(207.06086 versione senza i tiranti)</p>
 <p>cm 17 cm 67 cm 90</p>	<p>CALOTTA PARAFANGO POSTERIORE CON 4 TIRANTI 2a serie - P.P.T. - GRIGIO - (690mm) REAR MUDGUARD WITH 4 MUDGUARD TENSIONERS 2nd series - P.P.T. - GREY - (690mm)</p> <p>COS.PEL. ref. SIMILAR ref. 207.06077 81664106606 / 81664400192 DX-SX RH-LH</p> <p>(207.06087 versione senza i tiranti)</p>
 <p>cm 26 cm 65 cm 68</p>	<p>MEZZO PARAFANGO POSTERIORE PARTE ANT. P.P. - GRIGIO - SENZA STAFFE REAR MUDGUARD FRONT PART P.P. - GREY - W/O BRACKETS</p> <p>COS.PEL. ref. SIMILAR ref. 207.06082 81664100294 DX RH</p> <p>207.06083 81664100293 SX LH</p>
 <p>cm 27 cm 64 cm 69</p>	<p>MEZZO PARAFANGO POSTERIORE PARTE POST. P.P. - GRIGIO - SENZA STAFFE REAR MUDGUARD REAR PART P.P. - GREY - W/O BRACKETS</p> <p>COS.PEL. ref. SIMILAR ref. 207.06084 81664100172 DX RH</p> <p>207.06085 81664100173 SX LH</p>
 <p>cm 24 cm 68 cm 98</p>	<p>CALOTTA PARAFANGO POSTERIORE P.P.T. - GRIGIO - (680mm) REAR MUDGUARD P.P.T. - GREY - (680mm)</p> <p>COS.PEL. ref. SIMILAR ref. 207.06086 81664106086 DX-SX RH-LH</p> <p>Relativo tirante 1007.00001 - (207.06076 versione con i tiranti)</p>
 <p>cm 17 cm 67 cm 90</p>	<p>CALOTTA PARAFANGO POSTERIORE 2a serie - P.P.T. - GRIGIO REAR MUDGUARD 2nd series - P.P.T. - GREY</p> <p>COS.PEL. ref. SIMILAR ref. 207.06087 81664106606 DX-SX RH-LH</p> <p>Relativo tirante 1001.14951 - (207.06077 versione con i tiranti)</p>
	<p>PARAFANGO POSTERIORE PARTE POSTERIORE P.P. REAR WHEEL MUDGUARD - REAR P.P.</p> <p>COS.PEL. ref. SIMILAR ref. 207.06088 81664106625 DX-SX RH-LH</p>

TGX Euro 6

 <p>cm 69 cm 69 cm 26,5</p>	<p>PARAFANGO POSTERIORE PARTE ANTERIORE P.P. REAR WHEEL MUDGUARD - FRONT P.P.</p> <p>COS.PEL. ref. SIMILAR ref. 207.06090 81664106574 DX RH</p> <p>207.06089 81664106573 SX LH</p>
 <p>cm 68 cm 68</p>	<p>PARAFANGO POSTERIORE REAR WHEEL MUDGUARD</p> <p>COS.PEL. ref. SIMILAR ref. 207.06092 81664100463 DX RH</p> <p>207.06091 81664100462 SX LH</p>
 <p>cm 69 cm 69 cm 26,5</p>	<p>MEZZO PARAFANGO PARTE ANT. MUDGUARD FRONT PART</p> <p>COS.PEL. ref. SIMILAR ref. 207.06093 81664106599 DX-SX RH-LH</p>
	<p>MEZZO PARAFANGO POSTERIORE PARTE ANTERIORE REAR MUDGUARD FRONT PART</p> <p>COS.PEL. ref. SIMILAR ref. 207.06097 81664106608</p>
 <p>cm 69 cm 85 cm 17,7</p>	<p>CALOTTA PARAFANGO POSTERIORE REAR MUDGUARD</p> <p>COS.PEL. ref. SIMILAR ref. 207.06099 81664106607 DX-SX RH-LH</p> <p>Relativo tirante 1001.14951 - (207.06100 versione con i tiranti)</p>
 <p>cm 69 cm 85 cm 17,7</p>	<p>CALOTTA PARAFANGO POSTERIORE CON 4 TIRANTI REAR MUDGUARD WITH 4 MUDGUARD TENSIONERS</p> <p>COS.PEL. ref. SIMILAR ref. 207.06100 81664106607 / 81664400192 DX-SX RH-LH</p> <p>(207.06099 versione senza i tiranti)</p>
	<p>SPORTELLINO PEDANA P.P. - GRIGIO COVER FOOTSTEP P.P. - GREY</p> <p>COS.PEL. ref. SIMILAR ref. 307.00332 81615100468 / 81615100536 / 81615100822 / 81615100823</p>
	<p>VASCHETTA PEDANA CON TAPPO P.P.G.F. - GRIGIO (GUIDA A DESTRA) FOOTSTEP WITH COVER P.P.G.F. - GREY (RHD)</p> <p>COS.PEL. ref. SIMILAR ref. 307.00334 81615100800 DX RH</p> <p>Griglia/Grille: 1007.05187</p>

	<p>VASCETTA PEDANA (GUIDA A DESTRA) P.P.G.F. - GRIGIO FOOTSTEP (RHD) P.P.G.F. - GREY</p> <p>COS.PEL. ref. SIMILAR ref. 307.00335 81615100799</p> <p>Griglia/Grille: 1007.05187</p> <p style="text-align: right;">SX LH</p>
	<p>VASCETTA PEDANA CON TAPPO (GUIDA A DESTRA) P.P.G.F. - BIANCA FOOTSTEP WITH COVER (RDH) P.P.G.F. - WHITE</p> <p>COS.PEL. ref. SIMILAR ref. 307.00336 81615100804</p> <p>Griglia/Grille: 1007.05187</p> <p style="text-align: right;">DX RH</p>
	<p>VASCETTA PEDANA (GUIDA A DESTRA) P.P.G.F. - PRIMER FOOTSTEP (RHD) P.P.G.F. - PRIMER</p> <p>COS.PEL. ref. SIMILAR ref. 307.00337 81615100803</p> <p>Griglia/Grille : 1007.05187</p> <p style="text-align: right;">SX LH</p>
	<p>PEDANA CABINA LARGA S.M.C. - GRIGIO FOOTSTEP FOR LARGE CAB S.M.C. - GREY</p> <p>COS.PEL. ref. SIMILAR ref. 307.00400 81615100280 / 81615100400 / 307.00411 81615100704 / 81615100824</p> <p>Griglia/Grille: 1007.05188 inf - 1007.05189 sup 81615100331 / 81615100401 / 81615100405 / 81615100705 / 81615100827 Griglia/Grille: 1007.05188 inf - 1007.05189 sup</p> <p style="text-align: right;">DX RH SX LH</p>
	<p>PEDANA CABINA LARGA S.M.C. - PRIMER FOOTSTEP FOR LARGE CAB S.M.C. - PRIMER</p> <p>COS.PEL. ref. SIMILAR ref. 307.00402 81615100332 / 81615100402 / 307.00401 81615100704 / 81615100916</p> <p>Griglia/Grille : 1007.05188 inf - 1007.05189 sup 81615100331 / 81615100401 / 81615100405 / 81615100915 Griglia/Grille : 1007.05188 inf - 1007.05189 sup</p> <p style="text-align: right;">DX RH SX LH</p>
	<p>VASCETTA PEDANA P.P.G.F. - PRIMER FOOTSTEP P.P.G.F. - PRIMER</p> <p>COS.PEL. ref. SIMILAR ref. 307.00338 81615100752</p> <p>Griglia/Grille : 1007.05187 307.00339 81615100751 Griglia/Grille : 1007.05187</p> <p style="text-align: right;">DX RH SX LH</p>
	<p>VASCETTA PEDANA P.P.G.F. - GRIGIO FOOTSTEP P.P.G.F. - GREY</p> <p>COS.PEL. ref. SIMILAR ref. 307.00374 81615100312 / 81615100374 / 307.00333 81615100802</p> <p>Griglia/Grille : 1007.05187 81615100311 / 81615100333 / 81615100801 Griglia/Grille : 1007.05187</p> <p style="text-align: right;">DX RH SX LH</p>
	<p>PEDANA PARAURTI INFERIORE LOWER BUMPER STEP</p> <p>COS.PEL. ref. SIMILAR ref. 407.10193 81416142183</p>

TGX Euro 6

	<p>PEDANA PARAURTI SUPERIORE UPPER BUMPER STEP</p> <p>COS.PEL. ref. 407.10194 SIMILAR ref. 81416142184</p>
	<p>PROTEZIONE TAMPONAMENTO METALLO FRONT REINFORCEMENT STEEL</p> <p>COS.PEL. ref. 407.10195 SIMILAR ref. 81416505010</p>
	<p>ANGOLO PARAURTI PARTE SUPERIORE PRIMER - P.P. - CON FORO FENDI CORNER BUMPER PRIMER - P.P.</p> <p>COS.PEL. ref. 407.11088 SIMILAR ref. 81416106752 DX RH</p> <p>407.11089 81416106753 SX LH</p>
	<p>ANGOLO PARAURTI PARTE SUPERIORE PRIMER - P.P. CORNER BUMPER PRIMER - P.P.</p> <p>COS.PEL. ref. 407.11090 SIMILAR ref. 81416106750 DX RH</p> <p>407.11091 81416106751 SX LH</p>
	<p>ANGOLO PARAURTI PARTE INFERIORE PRIMER - P.P. CORNER BUMPER PRIMER - P.P.</p> <p>COS.PEL. ref. 407.11092 SIMILAR ref. 81416106754 DX RH</p> <p>407.11093 81416106755 SX LH</p>
	<p>SPOILER SOTTOPARAURTI P.P. - PRIMER LOWER BUMPER SPOILER P.P. - PRIMER</p> <p>COS.PEL. ref. 407.11094 SIMILAR ref. 81416140076</p>
	<p>PARAURTI CENTRALE PBT+PET-GF20/PET+PC - NERO CENTRAL BUMPER PBT+PET-GF20/PET+PC - BLACK</p> <p>COS.PEL. ref. 407.11095 SIMILAR ref. 81416106863</p>
	<p>PARAURTI CENTRALE PARTE INT. PBT+PET-GF20 - NERO BUMPER PBT+PET-GF20 - BLACK</p> <p>COS.PEL. ref. 407.11096 SIMILAR ref. 81416146009</p>

	<p>CERNIERA TAPPO TERGIFARO PBT+PET+GF20 HINGE PBT+PET+GF20 COS.PEL. ref. SIMILAR ref.</p> <p>407.11098 81416100575 DX RH</p> <p>407.11097 81416100744 SX LH</p>
	<p>COPERCHIO FORO TERGILAVAFARO PP/PE-TD20 - BIANCO HEADLAMP WASH HOLE COVER PP/PE-TD20 - WHITE COS.PEL. ref. SIMILAR ref.</p> <p>407.11100 81416100532 DX RH</p> <p>407.11099 81416100533 SX LH</p>
	<p>COPERCHIO PARAURTI PET+PC - NERO BUMPER COVER PET+PC - BLACK COS.PEL. ref. SIMILAR ref.</p> <p>407.11102 81416100558 DX RH</p> <p>407.11101 81416100559 SX LH</p>
	<p>CONVOGLIATORE ARIA PBT+PET-GF20 AIR CONVEYOR PBT+PET-GF20 COS.PEL. ref. SIMILAR ref.</p> <p>407.11104 81416140074 DX RH</p> <p>407.11103 81416140075 SX LH</p>
	<p>SPECCHIO RETROVISORE ELETTRICO RISCALDATO - G.A. - RISCALDATO MANUALE REAR-VIEW MIRROR ELECTRIC HEATED - W.A. - HEATED MANUAL COS.PEL. ref. SIMILAR ref.</p> <p>507.10500 81637306531 DX RH</p> <p>507.10501 81637306529 SX LH</p>
	<p>SPECCHIO RETROVISORE ELETTRICO RISCALDATO - G.A. - RISCALDATO ELETTRICO REAR-VIEW MIRROR ELECTRIC HEATED - W.A. - HEATED ELECTRIC COS.PEL. ref. SIMILAR ref.</p> <p>507.10502 81637306561 DX RH</p> <p>507.10503 81637306560 DX RH</p>
	<p>DEFLETTORE PBT-ASA+GF30 - BIANCO AIR CONVEYOR PBT-ASA+GF30 - WHITE COS.PEL. ref. SIMILAR ref.</p> <p>907.11180 81611100088 DX RH</p> <p>907.11181 81611100089 SX LH</p>
	<p>DEFLETTORE P.P. - NERO AIR CONVEYOR P.P. - BLACK COS.PEL. ref. SIMILAR ref.</p> <p>907.11182 81611100122 (81611100090) DX RH</p> <p>907.11183 81611100123 (81611100091) SX LH</p>

TGX Euro 6

	<p>GRIGLIA PEDANA SALITA INFERIORE METALLO INNER GRILLE FOOTSTEP METAL</p> <p>COS.PEL. ref. SIMILAR ref. 1007.05187 81615105187</p> <p style="text-align: right;">DX-SX RH-LH</p>
	<p>GRIGLIA PEDANA CENTRALE METALLO CENTRAL GRILLE FOOTSTEP METAL</p> <p>COS.PEL. ref. SIMILAR ref. 1007.05188 81615110001</p>
	<p>GRIGLIA PEDANA SUPERIORE METALLO UPPER GRILLE FOR FOOTSTEP METAL</p> <p>COS.PEL. ref. SIMILAR ref. 1007.05189 81615100273</p>
	<p>SUPPORTO FARO HEADLAMP HOUSING</p> <p>COS.PEL. ref. SIMILAR ref. 1107.11000 81416106760</p> <p style="text-align: right;">DX RH</p> <p>1107.11001 81416106759</p> <p style="text-align: right;">SX LH</p>
	<p>MANIGLIA PORTA CON CHIAVE DOOR HANDLE WITH KEY</p> <p>COS.PEL. ref. SIMILAR ref. 1707.00600 81626416080</p> <p style="text-align: right;">DX RH</p> <p>1707.00601 81626416081</p> <p style="text-align: right;">SX LH</p>
	<p>MANIGLIA PORTA INTERNA INNER DOOR HANDLE</p> <p>COS.PEL. ref. SIMILAR ref. 1707.00602 81626416068</p> <p style="text-align: right;">DX RH</p> <p>1707.00603 81626416067</p> <p style="text-align: right;">SX LH</p>
	<p>SERRATURA PORTA DOOR LOCK</p> <p>COS.PEL. ref. SIMILAR ref. 1707.00604 81626806142</p> <p style="text-align: right;">DX RH</p> <p>1707.00605 81626806143</p> <p style="text-align: right;">SX LH</p>
	<p>CERNIERA PORTA SUPERIORE UPPER DOOR HINGE</p> <p>COS.PEL. ref. SIMILAR ref. 1707.00606 81626906030 / 81626906048 / 81626906050 / 81626906052</p> <p style="text-align: right;">DX RH</p> <p>1707.00607 81616906051 / 81626906031 / 81626906047 / 81626906049</p> <p style="text-align: right;">SX LH</p>

	<p>CERNIERA PORTA INFERIORE LOWER DOOR HINGE</p> <p>COS.PEL. ref. SIMILAR ref. 1707.00608 81616906056 / 81626906046 / 81626906054 / 81626906062 / 81626906064 DX RH</p> <p>1707.00609 81626906045 / 81626906055 / 81626906061 / 81626906063 SX LH</p>
	<p>CICALINO DI RETROMARCIA LC8 destra Cicalino di retromarcia - 24V - 90db BUZZER LC8 right buzzer - 24V - 90db</p> <p>COS.PEL. ref. SIMILAR ref. 003092 -</p>
	<p>KIT PER CONNESSIONI ELETTRICHE Connettore AMP 1,5 singolo KIT FOR ELECTRICAL JOINTS Connector AMP 1,5 simple</p> <p>COS.PEL. ref. SIMILAR ref. 003120 -</p>
	<p>FANALE POSTERIORE CONNETTORE LATERALE AMP 1.5 REAR-LIGHT LATERAL CONNECTOR AMP 1.5</p> <p>COS.PEL. ref. SIMILAR ref. 1507.10000 8125225-6545 DX RH (ex 009214) - Relativo connettore 003120 1507.10001 8125225-6544 SX LH (ex 009215) - Relativo connettore 003120</p> <p>TRASPARENTE / LENS 1507.10100 8125229-6060 (ex 011012) DX RH 1507.10101 8125229-6059 (ex 011011) SX LH</p>
	<p>FANALE POSTERIORE CONNETTORE LATERALE AMP 1.5 REAR-LIGHT LATERAL CONNECTOR AMP 1.5</p> <p>COS.PEL. ref. SIMILAR ref. 1507.10002 8125225-6547 DX RH Con cicalino / With buzzer (ex 009216) - Connettore 003120</p> <p>TRASPARENTE / LENS 1507.10100 8125229-6060 (ex 011012) DX RH</p>











Parti di ricambio adattabili a:
Spare parts suitable to:

Proiettori Headlamps



PARTI DI RICAMBIO ADATTABILI A : COS.RE
SPARE PARTS SUITABLE TO :

	<p>Master 1999</p> <p>PROIETTORE H4/W5W - PREDISPOSTO PER CORRETTORE ASSETTO HEADLAMP H4/W5W - SUITABLE FOR LOAD LEVEL ADJUSTEMENT COS.PEL. ref. SIMILAR ref. 1601.00000 7701044520</p> <p>1601.00001 7701044518</p> <p style="text-align: right;">DX RH SX LH</p>
	<p>Master 2003</p> <p>PROIETTORE H7/H1/W5W - CORRETTORE ASSETTO MANUALE HEADLAMP H7/H1/W5W - MANUAL LOAD LEVEL ADJUSTEMENT COS.PEL. ref. SIMILAR ref. 1601.03800 8200163518</p> <p>1601.03801 8200163516</p> <p style="text-align: right;">DX RH SX LH</p>
	<p>Master 3 Phase 1 2010</p> <p>PROIETTORE H7/H7/H1/PY21W/W5W - CORRETTORE ASSETTO MANUALE HEADLAMP H7/H7/H1/PY21W/W5W - MANUAL LOAD LEVEL ADJUSTEMENT COS.PEL. ref. SIMILAR ref. 1601.04080 7485120611</p> <p>1601.04081 7485120616</p> <p style="text-align: right;">DX RH SX LH</p>
	<p>Master 3 Phase 1 2010</p> <p>FENDINEBBIA H11 FOG LAMP H11 COS.PEL. ref. SIMILAR ref. 1601.04082 8200002470 / 8200301027</p> <p>1601.04083 8200002469 / 8200301026</p> <p style="text-align: right;">DX RH SX LH</p>
	<p>Maxity 06 / Cabstar</p> <p>PROIETTORE H4/PY21W/W5W - ELETTRICO SENZA MOTORINO HEADLAMP H4/PY21W/W5W - ELECTRIC WITHOUT MOTOR COS.PEL. ref. SIMILAR ref. 1601.05060 5001872437</p> <p>1601.05061 5001872439</p> <p style="text-align: right;">DX RH SX LH</p>
	<p>Maxity 06 / Cabstar</p> <p>PROIETTORE H4/P21W/W5W - ELETTRICO SENZA MOTORINO HEADLAMP H4/P21W/W5W - ELECTRIC W/O MOTOR COS.PEL. ref. SIMILAR ref. 1601.05062 26010-MB400</p> <p>1601.05063 26060-MB400</p> <p style="text-align: right;">DX RH SX LH</p>
	<p>Maxity 06 / Cabstar</p> <p>FENDINEBBIA H11 FOG LAMP H11 COS.PEL. ref. SIMILAR ref. FO141602 1209177 / 8200074008</p> <p style="text-align: right;">DX-SX RH-LH</p>
	<p>Midlum</p> <p>PROIETTORE CON CORNICE H1/W5W - CORRETTORE ASSETTO MANUALE HEADLAMP WITH FRAME H1/W5W - MANUAL LOAD LEVEL ADJUSTEMENT COS.PEL. ref. SIMILAR ref. 1601.53600 5010468981</p> <p>1601.53601 5010468980</p> <p style="text-align: right;">DX RH SX LH</p>



 	<p>Premium</p> <p>PROIETTORE CON CORNICE H1/W5W - CORRETTORE ASSETTO MANUALE HEADLAMP WITH FRAME H1/W5W - MANUAL LOAD LEVEL ADJUSTEMENT COS.PEL. ref. SIMILAR ref. 1601.50016 5010468981 DX RH</p> <p>1601.50017 5010468980 SX LH</p>
 	<p>Premium</p> <p>PROIETTORE H1/W5W - CORRETTORE ASSETTO MANUALE HEADLAMP H1/W5W - MANUAL LOAD LEVEL ADJUSTEMENT COS.PEL. ref. SIMILAR ref. 1601.50020 5001840475 DX RH</p> <p>1601.50019 5001840476 SX LH</p>
 	<p>Premium</p> <p>PROIETTORE FENDINEBBIA H1 FOG LAMP H1 COS.PEL. ref. SIMILAR ref. 1601.50024 5010231850 DX RH</p> <p>1601.50023 5010231849 SX LH</p>
 	<p>Premium</p> <p>PROIETTORE H1/W5W - CON CORNICE - ELETTRICO SENZA MOTORINO HEADLAMP H1/W5W - WITH FRAME - ELECTRIC W/O MOTOR COS.PEL. ref. SIMILAR ref. 1601.50026 5010231670 DX RH</p> <p>1601.50027 5010231669 SX LH</p>
 	<p>Nuovo Premium</p> <p>PROIETTORE SENZA MOTORINO H1 H7 PY21W W5W FENDINEBBIA H3 - PREDISPOSTO PER CORRETTORE ASSETTO HEADLAMP WITHOUT MOTOR H1 H7 PY21W W5W FOG LAMP H3 - SUITABLE FOR LOAD LEVEL ADJUSTEMENT COS.PEL. ref. SIMILAR ref. 1601.30800 5010578476 / 7421636310 / DX RH 7482588693</p> <p>1601.30801 5010578452 / 7421636296 / SX LH 7482588679</p>
 	<p>Nuovo Premium</p> <p>PROIETTORE H1 H3 H7 PY21W W5W - CORRETTORE ASSETTO MANUALE - PARABOLA NERA HEADLAMP H1 H3 H7 PY21W W5W - MANUAL LOAD LEVEL ADJUSTEMENT - BLACK COS.PEL. ref. SIMILAR ref. 1601.30802 5010578478 / 7421636312 DX RH</p> <p>1601.30803 5010578454 / 7482588681 SX LH</p>
 	<p>Nuovo Premium</p> <p>PROIETTORE H1 H3 H7 PY21W W5W - CORRETTORE ASSETTO MANUALE - PARABOLA CHIARA HEADLAMP H1 H3 H7 PY21W W5W - MANUAL LOAD LEVEL ADJUSTEMENT - LIGHT COLOURED COS.PEL. ref. SIMILAR ref. 1601.30804 5010578475 / 7421636309 / DX RH 7482588692</p> <p>1601.30805 5010578451 / 7421636295 / SX LH 7482588678</p>
 	<p>AE - Magnum</p> <p>PROIETTORE H1 H7 PY21 W5W - PREDISPOSTO PER CORRETTORE ASSETTO HEADLAMP H1 H7 PY21 W5W - SUITABLE FOR LOAD LEVEL ADJUSTEMENT COS.PEL. ref. SIMILAR ref. 1601.23600 5010544978 / 5010623619 DX RH</p> <p>1601.23601 5010623620 SX LH</p>

Proiettori Headlamps



PARTI DI RICAMBIO ADATTABILI A : COS.RE
SPARE PARTS SUITABLE TO :

 	<p>AE - Magnum</p> <p>FENDINEBBIA H1 FOGLAMP H1 COS.PEL. ref. 1601.23603 SIMILAR ref. 5010312972 / 7420881197 DX-SX RH-LH</p>
 	<p>T</p> <p>PROIETTORE H1 H7 P21W W5W - CORRETTORE ASSETTO MANUALE HEADLAMP H1 H7 P21W W5W - MANUAL LOAD LEVEL ADJUSTEMENT COS.PEL. ref. 1601.29800 SIMILAR ref. 7482622151 / 7482622240 DX RH</p> <p>1601.29801 7482622235 / 7482622242 SX LH</p>
	<p>T</p> <p>PROIETTORE H7 H1 LED HEADLAMP H7 H1 LED COS.PEL. ref. 1601.29802 SIMILAR ref. 7482622272 DX RH</p> <p>1601.29803 7482622276 SX LH</p>
	<p>T</p> <p>FENDINEBBIA FOG LAMP COS.PEL. ref. 1601.29804 SIMILAR ref. 7482252916 DX RH</p> <p>1601.29805 7482252914 SX LH</p>



	<p>F-L 2006</p> <p>PROIETTORE H4 PY21W W5W - PREDISPOSTO PER CORRETTORE ASSETTO HEADLAMP H4 PY21W W5W - SUITABLE FOR LOAD LEVEL ADJUSTEMENT COS.PEL. ref. 1602.12700 SIMILAR ref. 20818771</p> <p>1602.12701 20818763</p> <p style="text-align: right;">DX RH SX LH</p>
	<p>F-E 2006</p> <p>FENDINEBBIA H11 FOG LAMP H11 COS.PEL. ref. 1602.12702 SIMILAR ref. 20779458</p> <p style="text-align: right;">DX-SX RH-LH</p>
	<p>F-L Euro 6</p> <p>PROIETTORE H7,PY21W - LED HEADLAMP H7,PY21W - LED COS.PEL. ref. 1602.31600 SIMILAR ref. 82532284</p> <p>1602.31601 82526640</p> <p style="text-align: right;">DX RH SX LH</p>
	<p>F-M 4/F-H 4</p> <p>PROIETTORE SENZA CENTRALINA H7 H1 PY21 LED - CORRETTORE ASSETTO MANUALE HEADLAMP W/O CONTROL UNIT H7 H1 PY21 LED - MANUAL LOAD LEVEL ADJUSTEMENT COS.PEL. ref. 1602.14800 SIMILAR ref. 21221129 / 22239217</p> <p>1602.14801 21221130 / 22239219</p> <p style="text-align: right;">DX RH SX LH</p>
	<p>F-M 4/F-H 4</p> <p>PROIETTORE SENZA CENTRALINA LED - CON MOTORINO - H7,H1,PY21W HEADLAMP W/O CONTROL UNIT LED - WITH MOTOR - H7,H1,PY21W COS.PEL. ref. 1602.14808 SIMILAR ref. 21221133 / 22239220</p> <p>1602.14807 21221134 / 22239221</p> <p style="text-align: right;">DX RH SX LH</p>
	<p>F 10-12-16</p> <p>PROIETTORE H4 - CORRETTORE ASSETTO MANUALE HEADLAMP H4 - MANUAL LOAD LEVEL ADJUSTEMENT COS.PEL. ref. 1602.93922 SIMILAR ref. 3175032</p> <p style="text-align: right;">DX-SX RH-LH</p>
	<p>F-H</p> <p>FANALINO CON PROFONDITA' H3 R5W LAMP H3 R5W COS.PEL. ref. 1602.60274 SIMILAR ref. 20360274</p> <p>1602.60273 20360273</p> <p style="text-align: right;">DX RH SX LH</p>
	<p>F-H</p> <p>FENDINEBBIA H3 FOG LAMP H3 COS.PEL. ref. 1602.81665 SIMILAR ref. 1062190 / 22105756</p> <p style="text-align: right;">DX-SX RH-LH</p>

Proiettori Headlamps



PARTI DI RICAMBIO ADATTABILI A : **COS.VO**
SPARE PARTS SUITABLE TO :

	<p>F-H</p> <p>PROIETTORE H4 - CORRETTORE ASSETTO MANUALE HEADLAMP H4 - MANUAL LOAD LEVEL ADJUSTEMENT COS.PEL. ref. SIMILAR ref. 1602.81669 3981594</p> <p style="text-align: right;">DX-SX RH-LH</p>
	<p>F-H vers.2</p> <p>PROIETTORE H7 - 12 PIN - ATTACCO RETTANGOLARE - PREDISPOSTO PER CORRETTORE ASSETTO HEADLAMP H7 - 12 PIN - RECTANGULAR MOUNT - SUITABLE FOR LOAD LEVEL ADJUSTEMENT COS.PEL. ref. SIMILAR ref. 1602.61664 20763003 / 20861574 / 21001649</p> <p style="text-align: right;">DX RH</p> <p>Connettore/Connector : 1602.61671 1602.61663 20763004 / 20861573 / 21001645</p> <p style="text-align: right;">SX LH</p>
	<p>F-H vers.2</p> <p>VETRO PROIETTORE HEADLAMP GLASS</p> <p>COS.PEL. ref. SIMILAR ref. 1602.61666 20379429 / 20710525</p> <p style="text-align: right;">DX RH</p> <p>1602.61665 20379428 / 20710524</p> <p style="text-align: right;">SX LH</p>
	<p>F-H vers.2</p> <p>PROIETTORE H7 H7 H7 - 9 PIN - ATTACCO ROTONDO - CORRETTORE ASSETTO MANUALE HEADLAMP H7 H7 H7 - 9 PIN - ROUND MOUNT - MANUAL LOAD LEVEL ADJUSTEMENT COS.PEL. ref. SIMILAR ref. 1602.61668 20360899 / 20762993 / 20861576 / 20713721 / 20861584 / 21001668</p> <p style="text-align: right;">DX RH</p> <p>1602.61667 20360898 / 20762992 / 20861583 / 20862575 / 20713720 / 21001663</p> <p style="text-align: right;">SX LH</p>
	<p>F-H 2008</p> <p>PROIETTORE H7 PY21W LED - CORRETTORE ASSETTO MANUALE HEADLAMP H7 PY21W LED - MANUAL LOAD LEVEL ADJUSTEMENT COS.PEL. ref. SIMILAR ref. 1602.13798 21123489 / 82304585</p> <p style="text-align: right;">DX RH</p> <p>1602.13799 21123523 / 82304599</p> <p style="text-align: right;">SX LH</p>
	<p>F-H 2008</p> <p>PROIETTORE H7 H3 - PREDISPOSTO PER CORRETTORE ASSETTO HEADLAMP H7 H3 - SUITABLE FOR LOAD LEVEL ADJUSTEMENT COS.PEL. ref. SIMILAR ref. 1602.13800 21035637 / 21323106</p> <p style="text-align: right;">DX RH</p> <p>1602.13801 21035638 / 21323108</p> <p style="text-align: right;">SX LH</p>
	<p>F-H 2008</p> <p>PROIETTORE LUCE PROFONDITA' H3 - PREDISPOSTO PER CORRETTORE ASSETTO HEADLAMP H3 - SUITABLE FOR LOAD LEVEL ADJUSTEMENT COS.PEL. ref. SIMILAR ref. 1602.13802 21035690 / 21297909</p> <p style="text-align: right;">DX RH</p> <p>1602.13803 21035692 / 21297911</p> <p style="text-align: right;">SX LH</p>
	<p>F-H 2008</p> <p>PROIETTORE XENON SENZA CENTRALINA D2S H7 PY21W LED - PREDISPOSTO PER CORRETTORE ASSETTO HEADLAMP XENON W/O CONTROL UNIT D2S H7 PY21W LED - SUITABLE FOR LOAD LEVEL ADJUSTEMENT COS.PEL. ref. SIMILAR ref. 1602.13808 21035644 / 21323113</p> <p style="text-align: right;">DX RH</p> <p>1602.13807 21035645 / 21323114</p> <p style="text-align: right;">SX LH</p>





	<p>F-H 2008</p> <p>FENDINEBBIA H3 H3 FOG LAMP H3 H3 COS.PEL. ref. 1602.13810 SIMILAR ref. 21297917</p> <p>1602.13809 21297918</p> <p style="text-align: right;">DX RH SX LH</p>
	<p>F-H 4</p> <p>PROIETTORE SENZA CENTRALINA H7 H1 PY21 LED - CORRETTORE ASSETTO MANUALE HEADLAMP W/O CONTROL UNIT H7 H1 PY21 LED - MANUAL LOAD LEVEL ADJUSTEMENT COS.PEL. ref. 1602.14802 SIMILAR ref. 21608661 / 22239225</p> <p>1602.14803 21608663 / 22239226</p> <p style="text-align: right;">DX RH SX LH</p>
	<p>F-H 4</p> <p>PROIETTORE XENON SENZA CENTRALINA D1S H1 PY21 LED - CORRETTORE ASSETTO MANUALE HEADLAMP XENON W/O CONTROL UNIT D1S H1 PY21 LED - MANUAL LOAD LEVEL ADJUSTEMENT COS.PEL. ref. 1602.14804 SIMILAR ref. 21221145 / 22239248</p> <p>1602.14805 21221142 / 22239254</p> <p style="text-align: right;">DX RH SX LH</p>
	<p>F-H 4</p> <p>PROIETTORE SENZA CENTRALINA LED - CON MOTORINO - H7,H1,PY21W HEADLAMP W/O CONTROL UNIT LED - WITH MOTOR - H7,H1,PY21W COS.PEL. ref. 1602.14814 SIMILAR ref. 21608666 / 22239232</p> <p>1602.14813 21608667 / 22239234</p> <p style="text-align: right;">DX RH SX LH</p>
	<p>F-H 4</p> <p>FENDINEBBIA BASE CROMATA H1 - H7 - BASE CROMATA FOG LAMP H1 - H7 - CHROME BASE COS.PEL. ref. 1602.14816 SIMILAR ref. 21221153 / 22332594</p> <p>1602.14815 21221154 / 22332595</p> <p style="text-align: right;">DX RH SX LH</p>
	<p>F-H 4</p> <p>FENDINEBBIA H7 - BASE NERA FOG LAMP H7 - BLACK BASE COS.PEL. ref. 1602.14818 SIMILAR ref. 21221155 / 22332596</p> <p>1602.14817 21221156 / 22332597</p> <p style="text-align: right;">DX RH SX LH</p>
	<p>F-H 4</p> <p>FENDINEBBIA H1 - H7 - BASE NERA FOG LAMP H1 - H7 - BLACK BASE COS.PEL. ref. 1602.14820 SIMILAR ref. 21221158 / 22332600</p> <p>1602.14819 21221157 / 22332598</p> <p style="text-align: right;">DX RH SX LH</p>
	<p>F-H 4</p> <p>FENDINEBBIA H7 - H7 - BASE NERA FOG LAMP H7 - H7 - BLACK BASE COS.PEL. ref. 1602.14822 SIMILAR ref. 21221159 / 22332603</p> <p>1602.14821 21221160 / 22332604</p> <p style="text-align: right;">DX RH SX LH</p>

Proiettori Headlamps



PARTI DI RICAMBIO ADATTABILI A : COS.VO
SPARE PARTS SUITABLE TO :

 	F-H 4		
	FENDINEBBIA H7 - BASE CROMATA FOG LAMP H7 - CHROMED BASE COS.PEL. ref. 1602.14824	SIMILAR ref. 21221151 / 22332592	DX RH
	1602.14823	21221152 / 22332593	SX LH



	<p>CR 142 - CR 143 Top Line</p> <p>PROIETTORE H4 - CORRETTORE ASSETTO MANUALE HEADLAMP H4 - MANUAL LOAD LEVEL ADJUSTEMENT COS.PEL. ref. 1603.13074 SIMILAR ref. 1308474</p> <p>1603.13073 1308473</p> <p style="text-align: right;">DX RH SX LH</p>
	<p>CR 114-124-144-164</p> <p>FENDINEBBIA H1 H1 FOG LAMP H1 H1 COS.PEL. ref. 1603.22992 SIMILAR ref. 1358832 / 1400208 / 1422992 / 1529071</p> <p>1603.22991 1358831 / 1400207 / 1422991 / 1529070</p> <p style="text-align: right;">DX RH SX LH</p>
	<p>CR 114-124-144-164</p> <p>PROIETTORE H4 - PREDISPOSTO PER CORRETTORE ASSETTO HEADLAMP H4 - SUITABLE FOR LOAD LEVEL ADJUSTEMENT COS.PEL. ref. 1603.67002 SIMILAR ref. 1431256 / 1446588 / 1467003 / 1732510</p> <p>1603.67001 1431257 / 1446587 / 1467000 / 1732509</p> <p style="text-align: right;">DX RH SX LH</p>
	<p>CR - R</p> <p>PROIETTORE LUCE PROFONDITA' PARTE INTERNA - H1 HEADLAMP INTERNAL SIDE - H1 COS.PEL. ref. 1603.45520 SIMILAR ref. 1446354 / 1852570 / 2248114</p> <p>1603.45521 1446353 / 1852569 / 2248103</p> <p style="text-align: right;">DX RH SX LH</p>
	<p>CR - R</p> <p>PROIETTORE FENDINEBBIA PARTE ESTERNA - H1 FOG LAMP EXTERNAL SIDE - H1 COS.PEL. ref. 1603.45522 SIMILAR ref. 1446356 / 1852573 / 2080689</p> <p>1603.45523 1446355 / 1852572 / 2080688</p> <p style="text-align: right;">DX RH SX LH</p>
	<p>CR - R</p> <p>PROIETTORE XENON SENZA CENTRALINA H7 D2R T4W(24V) - SENZA CENTRALINA HEADLAMP XENON W/O CONTROL UNIT H7 D2R T4W(24V) - WITHOUT CENTRAL UNIT COS.PEL. ref. 1603.45528 SIMILAR ref. 1760554 / 1892324 / 1900351 / 2442631</p> <p>1603.45527 1760551 / 1892322 / 1900349 / 2442629</p> <p style="text-align: right;">DX RH SX LH</p>
	<p>CR - R</p> <p>VETRO PROIETTORE HEADLAMP GLASS COS.PEL. ref. 1603.45530 SIMILAR ref. 1549815</p> <p>1603.45529 1549814</p> <p style="text-align: right;">DX RH SX LH</p>
	<p>CR - R 2010</p> <p>PROIETTORE SENZA CENTRALINA H7/H1/H21/LED - MANUALE HEADLAMP W/O CONTROL UNIT H7/H1/H21/LED - MANUAL COS.PEL. ref. 1603.46500 SIMILAR ref. 2241827</p> <p>1603.46501 2241826</p> <p style="text-align: right;">DX RH SX LH</p>

Proiettori Headlamps



PARTI DI RICAMBIO ADATTABILI A : COS.SCA
SPARE PARTS SUITABLE TO :

 	<p>CR - R 2010</p> <p>PROIETTORE H7/H1/H21/LED - ELETTRICO CON MOTORINO - LED HEADLAMP H7/H1/H21/LED - ELECTRIC WITH MOTOR - LED COS.PEL. ref. SIMILAR ref. 1603.46502 2241829 / 2416137</p> <p>1603.46503 2241828 / 2416136</p> <p style="text-align: right;">DX RH</p> <p style="text-align: right;">SX LH</p>
	<p>Sca 2017</p> <p>PROIETTORE H7*2 + H21W + LED HEADLAMP H7*2 + H21W + LED COS.PEL. ref. SIMILAR ref. 1603.48600 2379894 / 2655843</p> <p>1603.48601 2379890 / 2655842</p> <p style="text-align: right;">DX RH</p> <p style="text-align: right;">SX LH</p>
	<p>Sca 2017</p> <p>PROIETTORE H7*2 + H21W + LED HEADLAMP H7*2 + H21W + LED COS.PEL. ref. SIMILAR ref. 1603.48602 2379893 / 2655841</p> <p>1603.48603 2373889 / 2655840</p> <p style="text-align: right;">DX RH</p> <p style="text-align: right;">SX LH</p>



 	<p>LF Euro 6 PX5/LF Euro 6 PX7</p> <p>PROIETTORE H7 H1 PY21W LED HEADLAMP H7 H1 PY21W LED COS.PEL. ref. 1604.56604 SIMILAR ref. 1706997 / 1714559 DX RH</p> <p>1604.56605 1706996 / 1714558 SX LH</p>
 	<p>LF Euro 6 PX5/LF Euro 6 PX7/CF Euro 6</p> <p>FENDINEBBIA H11 FOG LAMP H11 COS.PEL. ref. 1604.56600 SIMILAR ref. 1892912 / 2032706 DX RH</p> <p>1604.56601 1892911 / 2032705 SX LH</p>
 	<p>LF Euro 6 PX5/LF Euro 6 PX7/CF Euro 6</p> <p>FENDINEBBIA CON SVOLTA ATTACCO LATERALE H11 FOG LAMP WITH SIDE CONNECTION H11 COS.PEL. ref. 1604.56602 SIMILAR ref. 1892914 / 2032708 DX RH</p> <p>1604.56603 1892913 / 2032707 SX LH</p>
 	<p>CF</p> <p>FENDINEBBIA H3 H3 FOG LAMP H3 H3 COS.PEL. ref. 1604.72500 SIMILAR ref. 1660963 / 1725273 DX RH</p> <p>1604.72501 1660962 / 1725272 SX LH</p>
 	<p>CF/XF 95 1aSerie XF 95 2aSerie/XF 105</p> <p>PROIETTORE H7 H1 P21W W5W - CORRETTORE ASSETTO MANUALE HEADLAMP H7 H1 P21W W5W - MANUAL LOAD LEVEL ADJUSTEMENT COS.PEL. ref. 1604.10580 SIMILAR ref. 1641743 / 1699301 / 1743685 DX RH</p> <p>1604.10581 1641742 / 1699300 / 1743684 SX LH</p>
 	<p>CF/XF 95 1aSerie XF 95 2aSerie/XF 105</p> <p>PROIETTORE XENON SENZA CENTRALINA D2S H1 PY21W W5W - PREDISPOSTO PER CORRETTORE ASSETTO HEADLAMP XENON W/O CONTROL UNIT D2S H1 PY21W W5W - SUITABLE FOR LOAD LEVEL ADJUSTEMENT COS.PEL. ref. 1604.10590 SIMILAR ref. 1636911 / 1699933 / 1743691 DX RH</p> <p>1604.10589 1699932 / 1743690 SX LH</p>
 	<p>CF Euro 6/XF 106</p> <p>PROIETTORE SENZA CENTRALINA H7 H1 PY21W - LED - MANUALE / ELETTRICO HEADLAMP W/O CONTROL UNIT H7 H1 PY21W - LED - MANUAL / ELECTRIC COS.PEL. ref. 1604.10600 SIMILAR ref. 1835875 DX RH</p> <p>1604.10601 1835874 SX LH</p>
 	<p>CF Euro 6/XF 106</p> <p>PROIETTORE SENZA CENTRALINA FULL LED - H1 PY21W 2 LED - MANUALE / ELETTRICO HEADLAMP W/O CONTROL UNIT FULL LED - H1 PY21W 2 LED - MANUAL / ELECTRIC COS.PEL. ref. 1604.10606 SIMILAR ref. 1857527 DX RH</p> <p>1604.10607 1857526 SX LH</p>

Proiettori Headlamps



PARTI DI RICAMBIO ADATTABILI A : COS.DA
SPARE PARTS SUITABLE TO :















	<div style="background-color: #00AEEF; color: white; padding: 2px;">XF 95 1aSerie XF 95 2aSerie</div> <p>PROIETTORE FENDINEBBIA H1 H3 FOG LAMP H1 H3 COS.PEL. ref. SIMILAR ref. 1604.10582 1328861 DX RH</p> <p>1604.10583 1328860 SX LH</p>
	<div style="background-color: #00AEEF; color: white; padding: 2px;">XF 105</div> <p>PROIETTORE FENDINEBBIA H3 FOG LAMP H3 COS.PEL. ref. SIMILAR ref. 1604.10584 1660961 / 1725271 DX RH</p> <p>1604.10585 1660960 / 1725270 SX LH</p>
	<div style="background-color: #00AEEF; color: white; padding: 2px;">XF 106</div> <p>FENDINEBBIA H11 FOG LAMP H11 COS.PEL. ref. SIMILAR ref. 1604.10602 1835887 / 2032704 DX RH</p> <p>1604.10603 1835886 / 2032703 SX LH</p>





	<p>Sprinter 2000</p> <p>PROIETTORE HEADLAMP</p> <p>COS.PEL. ref. 1605.91600 SIMILAR ref. A9018201161 DX RH</p> <p>1605.91601 A9018201061 SX LH</p>
	<p>Sprinter 2006</p> <p>FENDINEBBIA H11 FOG LAMP H11</p> <p>COS.PEL. ref. 1605.92600 SIMILAR ref. A2118200656 DX RH</p> <p>1605.92601 A2118200556 SX LH</p>
	<p>Sprinter 2006</p> <p>PROIETTORE SENZA FENDINEBBIA SENZA MOTORINO H7+H7 - PREDISPOSTO PER CORRETTORE ASSETTO HEADLAMP W/O FOGLAMP W/O MOTOR H7+H7 - SUITABLE FOR LOAD LEVEL ADJUSTMENT</p> <p>COS.PEL. ref. 1605.92602 SIMILAR ref. - DX RH</p> <p>1605.92603 - SX LH</p>
	<p>Sprinter 2006</p> <p>PROIETTORE SENZA FENDINEBBIA H7+H7 - CON MOTORINO ELETTRICO HEADLAMP W/O FOGLAMP H7+H7 - WITH MOTOR</p> <p>COS.PEL. ref. 1605.92604 SIMILAR ref. A9068200261 DX RH</p> <p>1605.92605 A9068200161 SX LH</p>
	<p>Sprinter 2006</p> <p>PROIETTORE CON FENDINEBBIA SENZA MOTORINO H7+H7+H7 - PREDISPOSTO PER CORRETTORE ASSETTO HEADLAMP WITH FOGLAMP W/O MOTOR H7+H7+H7 - SUITABLE FOR LOAD LEVEL ADJUSTMENT</p> <p>COS.PEL. ref. 1605.92606 SIMILAR ref. - DX RH</p> <p>1605.92607 - SX LH</p>
	<p>Sprinter 2006</p> <p>PROIETTORE CON FENDINEBBIA H7+H7+H7 - CON MOTORINO ELETTRICO HEADLAMP WITH FOGLAMP H7+H7+H7 - WITH MOTOR</p> <p>COS.PEL. ref. 1605.92608 SIMILAR ref. A9068200661 DX RH</p> <p>1605.92609 A9068200561 SX LH</p>
	<p>Sprinter 2014</p> <p>PROIETTORE H7*2/PY21W/W21W/W5W HEADLAMP H7*2/PY21W/W21W/W5W</p> <p>COS.PEL. ref. 1605.93600 SIMILAR ref. 9068202461 DX RH</p> <p>1605.93601 9068202361 SX LH</p>
	<p>Sprinter 2014</p> <p>FENDINEBBIA FOG LAMP</p> <p>COS.PEL. ref. 1605.93602 SIMILAR ref. 9068204161 DX RH</p> <p>1605.93603 9068204061 SX LH</p>

	<p>Sprinter 2014</p> <p>FENDI POSTERIORE P21W REAR FOG LAMP P21W COS.PEL. ref. 1605.93604 SIMILAR ref. A9068200356 DX RH</p> <p>1605.93605 A9068200256 SX LH</p>
	<p>Atego</p> <p>PROIETTORE CON FENDI H4 H1 W5W - PREDIS. PER COR.ASSETTO - CON MOTORINO HEADLAMP WITH FOG LAMP H4 H1 W5W - SUIT. FOR LOAD LEVEL ADJ. - WITH MOTOR COS.PEL. ref. 1605.97304 SIMILAR ref. 9738200661 DX RH</p> <p>1605.97305 9738200561 SX LH</p>
	<p>Atego</p> <p>PROIETTORE H4 W5W - PREDIS.PER CORR.ASS. - SENZA MOTORINO HEADLAMP H4 W5W - SUIT. FOR LOAD LEVEL ADJ. - W/O MOTOR COS.PEL. ref. 1605.97306 SIMILAR ref. 9738200261 DX RH</p> <p>1605.97307 9738200161 SX LH</p>
	<p>Atego</p> <p>PROIETTORE H7 H1 H1 W5W - PRED. PER CORR. ASSETTO - CON MOTORINO HEADLAMP H7 H1 H1 W5W - SUIT. FOR LOAD LEVEL ADJ. - WITH MOTOR COS.PEL. ref. 1605.97308 SIMILAR ref. 9738202961 DX RH</p> <p>1605.97309 9738202861 SX LH</p>
	<p>Atego</p> <p>PROIETTORE -> 12 - H7 H1 H1 W5W - PRED. PER CORR. ASSETTO - CON FENDINEBBIA HEADLAMP -> 12 - H7 H1 H1 W5W - SUIT. FOR LOAD LEVEL ADJ. - WITH FOG LAMP COS.PEL. ref. 1605.97314 SIMILAR ref. A9738202761 DX RH</p> <p>1605.97315 A9738202661 SX LH</p>
	<p>Atego</p> <p>PROIETTORE -> 12 - H7 H1 H1 W5W - PRED. PER CORR. ASSETTO - SENZA FENDINEBBIA HEADLAMP -> 12 - H7 H1 H1 W5W - SUIT. FOR LOAD LEVEL ADJ. - W/O FOG LAMP COS.PEL. ref. 1605.97316 SIMILAR ref. A9738202561 DX RH</p> <p>1605.97317 A9738202461 SX LH</p>
	<p>Axor</p> <p>PROIETTORE ELETTRICO HEADLAMP ELECTRIC COS.PEL. ref. 1605.94058 SIMILAR ref. A9408200461 DX RH</p> <p>1605.94059 A9408200361 SX LH</p>
	<p>Axor</p> <p>PROIETTORE H7 H1 - CORRETTORE ASSETTO MANUALE HEADLAMP H7 H1 - MANUAL LOAD LEVEL ADJUSTEMENT COS.PEL. ref. 1605.94060 SIMILAR ref. 9408200261 DX RH</p> <p>1605.94061 9408200161 SX LH</p>

 	<p>Axor</p> <p>PROIETTORE FENDINEBBIA H3 FOG LAMP H3 COS.PEL. ref. 1605.94066 SIMILAR ref. 9408200156 DX RH</p> <p>1605.94065 9408200056 SX LH</p>
 	<p>ActrosMP1/MegaSpaceMP1</p> <p>PROIETTORE H1 H4 - CORRETTORE ASSETTO MANUALE HEADLAMP H1 H4 - MANUAL LOAD LEVEL ADJUSTEMENT COS.PEL. ref. 1605.94160 SIMILAR ref. 9418202661 / 9418205261 DX RH</p> <p>1605.94161 9418202561 / 9418205161 SX LH</p>
 	<p>ActrosMP1/MegaSpaceMP1</p> <p>PROIETTORE P21W - H4 - W5W - CORRETTORE ASSETTO MANUALE HEADLAMP P21W - H4 - W5W - MANUAL LOAD LEVEL ADJUSTEMENT COS.PEL. ref. 1605.94164 SIMILAR ref. 0301081114 / 9418205461 DX RH</p> <p>1605.94165 0301081119 / 9418205361 SX LH</p>
<p>AD ESAURIMENTO SCORTE UNTIL SELL-OUT</p>  	<p>ActrosMP1/MegaSpaceMP1</p> <p>PROIETTORE H3 HEADLAMP H3 COS.PEL. ref. 1605.94168 SIMILAR ref. A0028208556 DX RH</p> <p>1605.94167 A0028208456 SX LH</p>
 	<p>ActrosMP1/MegaSpaceMP1</p> <p>FENDINEBBIA H3 FOG LAMP H3 COS.PEL. ref. 1605.94170 SIMILAR ref. A0028208756 DX RH</p> <p>1605.94169 A0028208656 SX LH</p>
	<p>ActrosMP2/MegaSpaceMP2</p> <p>PROIETTORE XENON SENZA CENTRALINA HEADLAMP XENON WITHOUT CONTROL UNIT COS.PEL. ref. 1605.94354 SIMILAR ref. 9438202361 DX RH</p> <p>1605.94355 9438202261 SX LH</p>
 	<p>ActrosMP2/MegaSpaceMP2</p> <p>PROIETTORE H1 H7 - PREDISPOSTO PER CORRETTORE ASSETTO HEADLAMP H1 H7 - SUITABLE FOR LOAD LEVEL ADJUSTEMENT COS.PEL. ref. 1605.94358 SIMILAR ref. 9438200461 DX RH</p> <p>1605.94359 9438200361 SX LH</p>
 	<p>ActrosMP2/MegaSpaceMP2</p> <p>PROIETTORE H1 H7 - CORRETTORE ASSETTO MANUALE HEADLAMP H1 H7 - MANUAL LOAD LEVEL ADJUSTEMENT COS.PEL. ref. 1605.94360 SIMILAR ref. 9438200261 DX RH</p> <p>1605.94361 9438200161 SX LH</p>

 	<p>ActrosMP2/MegaSpaceMP2</p> <p>FENDINEBBIA H3 FOG LAMP H3 COS.PEL. ref. 1605.94362 SIMILAR ref. 9438200156 DX RH</p> <p>1605.94363 9438200056 SX LH</p>
	<p>ActrosMP2/MegaSpaceMP2</p> <p>CORNICE FARO HEADLAMP BEZEL COS.PEL. ref. 1605.94370 SIMILAR ref. 9438260359 DX RH</p> <p>1605.94371 9438260259 SX LH</p>
 	<p>ActrosMP3/MegaSpaceMP3</p> <p>PROIETTORE H1 H7 - CORRETTORE ASSETTO MANUALE HEADLAMP H1 H7 - MANUAL LOAD LEVEL ADJUSTEMENT COS.PEL. ref. 1605.94364 SIMILAR ref. A9438201561 DX RH</p> <p>1605.94365 A9438201461 SX LH</p>
 	<p>ActrosMP3/MegaSpaceMP3</p> <p>PROIETTORE H1 H7 - PREDISPOSTO PER CORRETTORE ASSETTO HEADLAMP H1 H7 - SUITABLE FOR LOAD LEVEL ADJUSTEMENT COS.PEL. ref. 1605.94366 SIMILAR ref. A9438201761 DX RH</p> <p>1605.94367 A9438201661 SX LH</p>
 	<p>ActrosMP3/MegaSpaceMP3</p> <p>VETRO PROIETTORE HEADLAMP GLASS COS.PEL. ref. 1605.94368 SIMILAR ref. 0008264610 DX RH</p> <p>1605.94369 0008264710 SX LH</p>
 	<p>BigSpace/GigaSpace/MP4/StreamSpace</p> <p>PROIETTORE H7-H1-PY21W-W5W HEADLAMP H7-H1-PY21W-W5W COS.PEL. ref. 1605.96100 SIMILAR ref. 9608200339 DX RH</p> <p>1605.96101 9608200239 SX LH</p>
 	<p>BigSpace/GigaSpace/MP4/StreamSpace</p> <p>PROIETTORE XENON HID SENZA CENTRALINA D1S-H1-PY21W-W5W XENON HEADLAMP HID W/O CONTROL UNIT D1S-H1-PY21W-W5W COS.PEL. ref. 1605.96102 SIMILAR ref. 9608200739 DX RH</p> <p>1605.96103 9608200639 SX LH</p>
 	<p>BigSpace/GigaSpace/MP4/StreamSpace</p> <p>PROIETTORE H7-H1-PY21W-W5W-H21W - DAYTIME RUNNING LAMP LAMP H7-H1-PY21W-W5W-H21W - DAYTIME RUNNING LAMP COS.PEL. ref. 1605.96104 SIMILAR ref. 9608200539 DX RH</p> <p>1605.96105 9608200439 SX LH</p>

	<p>BigSpace/GigaSpace/MP4/StreamSpace</p> <p>STRISCIA LED LED STRIP</p> <p>COS.PEL. ref. 1605.96106 SIMILAR ref. A9608201056 DX RH</p> <p>1605.96107 A9608200956 SX LH</p>
 	<p>BigSpace/GigaSpace/MP4/StreamSpace</p> <p>PROIETTORE FENDINEBBIA H11 FOG LAMP H11</p> <p>COS.PEL. ref. 1605.96108 SIMILAR ref. A9608200556 DX RH</p> <p>1605.96109 A9608200456 SX LH</p>
 	<p>BigSpace/GigaSpace/MP4/StreamSpace</p> <p>PROIETTORE SENZA CENTRALINA D1S H1 PY21W H21W W5W HEADLAMP W/O CONTROL UNIT D1S H1 PY21W H21W W5W</p> <p>COS.PEL. ref. 1605.96112 SIMILAR ref. A9608200939 DX RH</p> <p>1605.96113 A9608200839 SX LH</p>

Proiettori Headlamps



PARTI DI RICAMBIO ADATTABILI A : COS.IVE
SPARE PARTS SUITABLE TO :

 	<p>Daily 96</p> <p>PROIETTORE H4 - PREDISPOSTO PER CORRETTORE ASSETTO HEADLAMP H4 - SUITABLE FOR LOAD LEVEL ADJUSTEMENT COS.PEL. ref. SIMILAR ref. 1606.93900 98433939</p> <p style="text-align: right;">DX RH</p> <p>1606.93901 98433940</p> <p style="text-align: right;">SX LH</p>
 	<p>Daily 96</p> <p>PROIETTORE H4 - CORRETTORE ASSETTO MANUALE HEADLAMP H4 - MANUAL LOAD LEVEL ADJUSTEMENT COS.PEL. ref. SIMILAR ref. 1606.93902 98433941</p> <p style="text-align: right;">DX RH</p> <p>1606.93903 98433942</p> <p style="text-align: right;">SX LH</p>
 	<p>Daily S2000</p> <p>PROIETTORE H1 H7 - PREDISPOSTO PER CORRETTORE ASSETTO HEADLAMP H1 H7 - SUITABLE FOR LOAD LEVEL ADJUSTEMENT COS.PEL. ref. SIMILAR ref. 1606.35012 500307754</p> <p style="text-align: right;">DX RH</p> <p>1606.35013 500307755</p> <p style="text-align: right;">SX LH</p>
 	<p>Daily 2006</p> <p>PROIETTORE H1 H1 H7 - PREDISPOSTO PER CORRETTORE ASSETTO HEADLAMP H1 H1 H7 - SUITABLE FOR LOAD LEVEL ADJUSTEMENT COS.PEL. ref. SIMILAR ref. 1606.39200 69500010</p> <p style="text-align: right;">DX RH</p> <p>1606.39201 69500013</p> <p style="text-align: right;">SX LH</p>
 	<p>Daily 2010</p> <p>FENDINEBBIA FOG LAMP</p> <p>COS.PEL. ref. SIMILAR ref. 1606.41032 5801377880</p> <p style="text-align: right;">DX RH</p> <p>1606.41033 5801377881</p> <p style="text-align: right;">SX LH</p>
 	<p>Daily 2010</p> <p>PROIETTORE H7 H1 W21 5W PY21W HEADLAMP H7 H1 W21 5W PY21W COS.PEL. ref. SIMILAR ref. 1606.41034 5801375415</p> <p style="text-align: right;">DX RH</p> <p>1606.41035 5801375416</p> <p style="text-align: right;">SX LH</p>
 	<p>Daily 2014</p> <p>PROIETTORE H7 H1 W21W W5W HEADLAMP H7 H1 W21W W5W COS.PEL. ref. SIMILAR ref. 1606.40600 5801473749</p> <p style="text-align: right;">DX RH</p> <p>1606.40601 5801473750</p> <p style="text-align: right;">SX LH</p>
 	<p>Daily 2014</p> <p>FENDINEBBIA H11 FOG LAMP H11 COS.PEL. ref. SIMILAR ref. 1606.40604 5801587021</p> <p style="text-align: right;">DX-SX RH-LH</p> <p style="text-align: center;">Portalamпада con relativa lampada 012.H1109</p>



	<p>Eurocargo 60/Eurocargo 120</p> <p>PROIETTORE H4 - PREDISPOSTO PER CORRETTORE ASSETTO HEADLAMP H4 - SUITABLE FOR LOAD LEVEL ADJUSTEMENT COS.PEL. ref. 1606.75122 SIMILAR ref. 500340361</p> <p>DX RH</p> <p>1606.75121 500340408 SX LH</p>
	<p>Eurocargo 60/Eurocargo 120</p> <p>PROIETTORE H4 - CORRETTORE ASSETTO MANUALE HEADLAMP H4 - MANUAL LOAD LEVEL ADJUSTEMENT COS.PEL. ref. 1606.75200 SIMILAR ref. 500340503</p> <p>DX RH</p> <p>1606.75201 500340543 SX LH</p>
	<p>Eurocargo 60/Eurocargo 120/Eurotech</p> <p>FENDINEBBIA H3 FOG LAMP H3 COS.PEL. ref. 1606.60110 SIMILAR ref. 98437475</p> <p>DX RH</p> <p>1606.60111 98437476 SX LH</p>
	<p>Eurocargo 75e13/120e21/Eurocargo 130e24/180e28</p> <p>FENDINEBBIA H1 FOG LAMP H1 COS.PEL. ref. 1606.75602 SIMILAR ref. 504052352</p> <p>DX RH</p> <p>1606.75601 504052353 SX LH</p>
	<p>Eurocargo 75e13/120e21/Eurocargo 130e24/180e28/Tector 160e18/180e30/Stralis AD/AT/Stralis AS</p> <p>PROIETTORE H7 H7 - CORRETTORE ASSETTO MANUALE / ELETTRICO SENZA MOTORINO HEADLAMP H7 H7 - MANUAL LOAD LEVEL ADJUSTEMENT / ELECTRIC W/O MOTOR COS.PEL. ref. 1606.80038 SIMILAR ref. 504020189</p> <p>DX RH</p> <p>1606.80039 504020193 SX LH</p>
	<p>Eurocargo 2009 75e13/120e18/Eurocargo 2009 120e21/180e28/Eurocargo 75-2015/Eurocargo 130-2015/Nuovo Stralis</p> <p>PROIETTORE FENDINEBBIA ESTERNO H1 - 08 -> OUTSIDE FOG LAMP H1 - 08 -> COS.PEL. ref. 1606.90606 SIMILAR ref. 504181095</p> <p>DX-SX RH-LH</p>
	<p>Eurocargo 2009 75e13/120e18/Eurocargo 2009 120e21/180e28/Nuovo Stralis 2007 AD - AT/Nuovo Stralis 2007 AS</p> <p>PROIETTORE H7 H7 - 08-> - CORRETTORE ASSETTO MANUALE HEADLAMP H7 H7 - 08-> - MANUAL LOAD LEVEL ADJUSTEMENT COS.PEL. ref. 1606.90600 SIMILAR ref. 504238093</p> <p>DX RH</p> <p>1606.90601 504238117 SX LH</p>
	<p>Eurocargo 75-2015/Eurocargo 130-2015/Stralis 2013 HI-WAY - AD/AT</p> <p>PROIETTORE CORRETTORE ASSETTO MANUALE - CON CENTRALINA FRONT LAMP MANUAL LOAD LEVEL ADJUSTEMENT - WITH CONTROL UNIT COS.PEL. ref. 1606.92800 SIMILAR ref. 5801745452</p> <p>DX RH</p> <p>1606.92801 Relativa centralina 1606.92812 5801745449 SX LH</p> <p>Relativa centralina 1606.92812</p>

ALL ITEMS MENTIONED IN OUR CATALOGUE ARE NOT ORIGINAL PARTS BUT PERFECTLY INTERCHANGEABLE WITH THEM.

GOVERNING LEGISLATIONS FOR THE SALE OF OUR PRODUCTS DIFFER IN EACH COUNTRY.

INFRINGEMENTS, IF ANY, OF LOCAL LEGISLATIONS ARE RESPONSIBILITY OF THE RETAILER IN THE COUNTRY OF FINAL DISTRIBUTION.



Proiettori Headlamps



PARTI DI RICAMBIO ADATTABILI A : **COS.IVE**
 SPARE PARTS SUITABLE TO :

 	<p>Eurocargo 75-2015/Eurocargo 130-2015/Stralis 2013 HI-WAY - AD/AT/Stralis 2013 HI-WAY - AS</p> <p>PROIETTORE CORRETTORE ASSETTO MANUALE SENZA CENTRALINA HEADLAMP MANUAL LOAD LEVEL ADJUSTEMENT WITHOUT ELECTRONIC CONTROL UNIT COS.PEL. ref. SIMILAR ref. 1606.92808 -</p> <p>1606.92809 -</p> <p style="text-align: right;">DX RH SX LH</p>
 	<p>115.17 / 135.17 / 145.17</p> <p>PROIETTORE HEADLAMP</p> <p>COS.PEL. ref. SIMILAR ref. 1606.11510 4814863</p> <p style="text-align: right;">DX-SX RH-LH</p>
 	<p>Eurotech/Eurostar</p> <p>PROIETTORE H4 H3 - PREDISPOSTO PER CORRETTORE ASSETTO HEADLAMP H4 H3 - SUITABLE FOR LOAD LEVEL ADJUSTEMENT COS.PEL. ref. SIMILAR ref. 1606.05102 500305102</p> <p>1606.05103 500305103</p> <p style="text-align: right;">DX RH SX LH</p>
 	<p>Eurotech/Eurostar</p> <p>PROIETTORE H3 H4 - CORRETTORE ASSETTO MANUALE HEADLAMP H3 H4 - MANUAL LOAD LEVEL ADJUSTEMENT COS.PEL. ref. SIMILAR ref. 1606.48440 4861793</p> <p>1606.48441 4861794</p> <p style="text-align: right;">DX RH SX LH</p>
 	<p>Stralis AD/AT/Stralis AS</p> <p>FENDINEBBIA ESTERNO H1 -> 07 OUTSIDE FOG LAMP H1 -> 07 COS.PEL. ref. SIMILAR ref. 1606.80042 504032145</p> <p style="text-align: right;">DX-SX RH-LH</p>
 	<p>Stralis AD/AT/Stralis AS</p> <p>FENDINEBBIA INTERNO H1 -> 07 INSIDE FOG LAMP H1 -> 07 COS.PEL. ref. SIMILAR ref. 1606.80043 504032148</p> <p style="text-align: right;">DX-SX RH-LH</p>
 	<p>Nuovo Stralis 2007 AD - AT/Nuovo Stralis 2007 AS</p> <p>PROIETTORE PROFONDITA' INTERNO H1 - 08 -> INNER LAMP H1 - 08 -> COS.PEL. ref. SIMILAR ref. 1606.90607 504181096</p> <p style="text-align: right;">DX-SX RH-LH</p>
	<p>Stralis 2013 HI-WAY - AD/AT/Stralis 2013 HI-WAY - AS</p> <p>PROIETTORE CON CENTRALINA XENON - D1S - LED - CON CENTRALINA HEADLAMP WITH CONTROL UNIT XENON - D1S - LED - WITH CONTROL UNIT COS.PEL. ref. SIMILAR ref. 1606.92798 5801745442</p> <p>1606.92799 Relativa centralina 1606.92812 5801745441</p> <p style="text-align: right;">DX RH SX LH</p> <p style="text-align: center;">Relativa centralina 1606.92812</p>







 	<p>TGA XL/XXL</p> <p>PROIETTORE H7 W5W - CORRETTORE ASSETTO MANUALE HEADLAMP H7 W5W - MANUAL LOAD LEVEL ADJUSTEMENT COS.PEL. ref. 1607.00700 SIMILAR ref. 81251016448</p> <p>DX RH</p> <p>1607.00701 81251016449 SX LH</p>
 	<p>TGA XL/XXL</p> <p>PROIETTORI H7 W5W - PREDISPOSTO PER CORRETTORE ASSETTO HEADLAMP H7 W5W - SUITABLE FOR LOAD LEVEL ADJUSTEMENT COS.PEL. ref. 1607.00702 SIMILAR ref. 81251016450</p> <p>DX RH</p> <p>1607.00703 81251016451 SX LH</p>
 	<p>TGA XL/XXL</p> <p>FENDINEBBIA CON FRECCIA GIALLA H4 P21W FOG LAMP H4 P21W COS.PEL. ref. 1607.00704 SIMILAR ref. 81253206092 / 81253206112</p> <p>DX RH</p> <p>1607.00705 81253206091 / 81253206111 SX LH</p>
 	<p>TGA XL/XXL</p> <p>FENDINEBBIA CON FRECCIA BIANCA H4 P21W FOG LAMP H4 P21W COS.PEL. ref. 1607.00706 SIMILAR ref. 81253206114</p> <p>DX RH</p> <p>1607.00707 81253206113 SX LH</p>
 	<p>TGA XL/XXL</p> <p>FARO SENZA FENDI CON FRECCIA GIALLA P21W - SENZA FENDINEBBIA LAMP P21W - W/O FOG LAMP COS.PEL. ref. 1607.00716 SIMILAR ref. 81253206090</p> <p>DX RH</p> <p>1607.00715 81253206089 SX LH</p>
 	<p>TGS/TGX</p> <p>PROIETTORE MANUALE CON LED PARKING MANUALE - H7*2+PY21W+LED - SENZA DAYTIME - 4+2 Pin HEADLAMP MANUAL WITH LED PARKING MANUAL - H7*2+PY21W+LED - W/O DAYTIME - 4+2 Pin COS.PEL. ref. 1607.10746 SIMILAR ref. 81251016658 / 81251016682</p> <p>DX RH</p> <p>1607.10747 81251016657 / 81251016681 SX LH</p>
 	<p>TGS/TGX</p> <p>PROIETTORE ELETTRICO CON MOTORINO LED P. - DAYTIME - H7*2+PY21W+H21W+LED - 6+3 Pin HEADLAMP WITH MOTOR W. LED P. - W. DAYTIME - H7*2+PY21W+H21W+LED - 6+3 Pin COS.PEL. ref. 1607.10748 SIMILAR ref. 81251016504 / 81251016664 / 81251016688</p> <p>DX RH</p> <p>1607.10749 81251016503 / 81251016663 / 81251016687 SX LH</p>
<p>AD ESAURIMENTO SCORTE UNTIL SELL-OUT</p>  	<p>TGS/TGX</p> <p>PROIETTORE MANUALE SENZA MOTORINO H7*2+PY21W - MANUALE SENZA MOTOR. - LED P. - 6+2 Pin HEADLAMP WITHOUT MOTOR H7*2+PY21W - MANUAL W/O MOTOR - LED P. - 6+2 Pin COS.PEL. ref. 1607.10750 SIMILAR ref. -</p> <p>DX RH</p>

Proiettori Headlamps



PARTI DI RICAMBIO ADATTABILI A : COS.MA
SPARE PARTS SUITABLE TO :

 	<p>TGS/TGX</p> <p>FENDINEBBIA H3 H4 FOG LAMP H3 H4 COS.PEL. ref. SIMILAR ref.</p> <p>1607.10752 81251016522 DX RH</p> <p>1607.10753 81251016521 SX LH</p>
 	<p>TGS/TGX</p> <p>PROIETTORE ELETTRICO CON MOTORINO H7*2+PY21W - ELETTRICO CON MOTOR. - LED P. - 6+2 Pin HEADLAMP WITH MOTOR H7*2+PY21W - ELECTRIC WITH MOTOR - LED P. - 6+2 Pin COS.PEL. ref. SIMILAR ref.</p> <p>1607.10754 81251016498 / 81251016660 / DX RH 81251016684</p> <p>1607.10755 81251016499 / 81251016659 / SX LH 81251016683</p>





Parti di ricambio adattabili a:
Spare parts suitable to:

Fari posteriori Rear lightings



PARTI DI RICAMBIO ADATTABILI A :
SPARE PARTS SUITABLE TO : **COS.RE**

 	<p>Master 2003</p> <p>FARO POSTERIORE REAR-LIGHT PY21W PY21W</p> <p>COS.PEL. ref. 003810 SIMILAR ref. 8200228395 DX RH</p> <p>003811 8200228394 SX LH</p> <p>TRASPARENTE / LENS</p>
 <p>cm 15,2</p>	<p>Master 2003/Maxity 06 / Cabstar/Mascot 1998/Midlum</p> <p>FANALE POSTERIORE REAR-LIGHT 5 FUNZIONI - CONNETTORE POSTERIORE AMP 1.5 5 FUNCTIONS - REAR CONNECTOR AMP 1.5</p> <p>COS.PEL. ref. 1501.03000 SIMILAR ref. 4421266 / 5001870556 DX RH (ex 007880/007900) - Connettore 003120</p> <p>1501.03001 4421265 / 7485118470 SX LH Con luce targa / W. plate light (ex 007880/007900) - Conn. 003120</p> <p>TRASPARENTE / LENS 1501.03100 5001847153 (ex 011591) DX-SX RH-LH</p>
 	<p>Master 3 Phase 1 2010</p> <p>FANALE POSTERIORE REAR-LIGHT SENZA PORTALAMPADA WITHOUT LAMPHOLDER</p> <p>COS.PEL. ref. 007910 SIMILAR ref. 265500023R / 7485120625 DX RH</p> <p>007911 26550023L / 7485120626 SX LH</p> <p>TRASPARENTE / LENS</p>
 <p>cm 15,5</p>	<p>Premium</p> <p>FANALE POSTERIORE REAR-LIGHT 7 FUNZIONI 7 FUNCTIONS</p> <p>COS.PEL. ref. 006120 SIMILAR ref. 5001847587 DX RH Relativo connettore 003120</p> <p>006130 5001847584 SX LH Con luce targa / With plate light - conn. 003120</p> <p>TRASPARENTE / LENS 011111 5000296594 DX-SX RH-LH</p>
 <p>cm 15,5</p>	<p>Premium</p> <p>FANALE POSTERIORE REAR LIGHTING LED LED LED</p> <p>COS.PEL. ref. 006122 SIMILAR ref. - DX RH Relativo connettore 003120</p> <p>006121 - SX LH Con luce targa / With plate light - conn. 003120</p> <p>TRASPARENTE / LENS 011112 - DX-SX RH-LH</p>
 <p>cm 15,5</p>	<p>Premium</p> <p>FANALE POSTERIORE REAR-LIGHT 7 FUNZIONI - SENZA LUCE TARGA 7 FUNCTIONS - WITHOUT PLATE LIGHT</p> <p>COS.PEL. ref. 006131 SIMILAR ref. 5001847584 / 5001847586 SX LH Relativo connettore 003120</p> <p>TRASPARENTE / LENS 011111 5000296594 DX-SX RH-LH</p>
 <p>cm 15,2</p>	<p>Premium</p> <p>FANALE POSTERIORE REAR-LIGHT 7 FUNZIONI 7 FUNCTIONS</p> <p>COS.PEL. ref. 1504.10500 SIMILAR ref. 5001847587 DX RH Relativo connettore 003120</p> <p>1504.10501 5001847584 SX LH Con luce targa / With plate light - conn. 003120</p> <p>TRASPARENTE / LENS 011111 5000296594 DX-SX RH-LH</p>
 <p>15,2 cm</p>	<p>Nuovo Premium</p> <p>FANALE POSTERIORE REAR-LIGHT LED - 24V - CONNETTORE POSTERIORE AMP 1.5 LED - 24V - REAR CONNECTOR AMP 1.5</p> <p>COS.PEL. ref. 1500.00000 SIMILAR ref. - DX RH Relativo connettore multipolare 003120</p> <p>1500.00001 - SX LH Relativo connettore multipolare 003120</p> <p>TRASPARENTE / LENS</p>

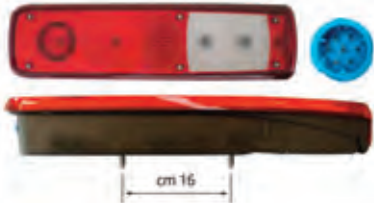
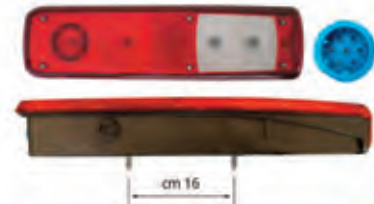

 <p>cm 16</p>	<p>Nuovo Premium/T</p> <p>FANALE COMPLETO REAR LIGHTING 7 FUNZIONI - CONNETTORE LATERALE AMP 1.5 7 FUNCTIONS - LATERAL CONNECTOR AMP 1.5</p> <p>COS.PEL. ref. 1501.30000 SIMILAR ref. 7420802350 DX RH Relativo connettore 003120 COS.PEL. ref. 1501.30001 7420802348 SX LH Con luce targa / With plate light (ex 006015) - Conn. 003120 TRASPARENTE / LENS 1501.30100 7420802418 (ex 010082) DX-SX RH-LH</p>
 <p>cm 16</p>	<p>Nuovo Premium/T</p> <p>FANALE POSTERIORE REAR-LIGHT 7 FUNZIONI - CONNETTORE LATERALE AMP 1.5 7 FUNCTIONS - LATERAL CONNECTOR AMP 1.5</p> <p>COS.PEL. ref. 1501.30002 SIMILAR ref. 7420802353 DX RH Con cicalino / With buzzer (ex 006016) - Connettore 003120 TRASPARENTE / LENS 1501.30100 7420802418 (ex 010082) DX-SX RH-LH</p>
 <p>cm 16</p>	<p>T</p> <p>FANALE POSTERIORE REAR-LIGHT LED - 24V - CONNETTORE LATERALE AMP 1.5 LED - 24V - LATERAL CONNECTOR AMP 1.5</p> <p>COS.PEL. ref. 1502.14000 SIMILAR ref. - DX RH Relativo connettore 003120 1502.14001 7425982261 SX LH Con luce targa / With plate light - Relativo connettore 003120 TRASPARENTE / LENS 1502.14100 7422800391 DX-SX RH-LH</p>
 <p>cm 16</p>	<p>T</p> <p>FANALE POSTERIORE REAR-LIGHT LED - 24V - CONNETTORE LATERALE AMP 1.5 LED - 24V - LATERAL CONNECTOR AMP 1.5</p> <p>COS.PEL. ref. 1502.14002 SIMILAR ref. 7425982262 DX RH Con cicalino / With buzzer - Relativo connettore 003120 TRASPARENTE / LENS 1502.14100 7422800391 DX-SX RH-LH</p>

Fari posteriori Rear lightings



PARTI DI RICAMBIO ADATTABILI A :
SPARE PARTS SUITABLE TO : **COS.VO**

 <p>cm 15,2</p>	<p>F-E 2006</p> <p>FANALE POSTERIORE REAR-LIGHT 5 FUNZIONI - CONNETTORE POSTERIORE AMP 1.5 5 FUNCTIONS - REAR CONNECTOR AMP 1.5</p> <p>COS.PEL. ref. 1501.03000 SIMILAR ref. 20769784 DX RH (ex 007880/007900) - Connettore 003120</p> <p>1501.03001 20769783 SX LH Con luce targa / W. plate light (ex 007880/007900) - Conn. 003120</p> <p>TRASPARENTE / LENS 1501.03100 20537280 (ex 011591) DX-SX RH-LH</p>
 <p>cm 16</p>	<p>F-L Euro 6 / F-M 4 / F-H 4</p> <p>FANALE POSTERIORE REAR-LIGHT LED - 24V - CONNETTORE LATERALE AMP 1.5 LED - 24V - LATERAL CONNECTOR AMP 1.5</p> <p>COS.PEL. ref. 1502.14004 SIMILAR ref. 21735299 / 84441937 DX RH Relativo connettore 003120</p> <p>1502.14003 21735301 / 84441936 SX LH Relativo connettore 003120</p> <p>TRASPARENTE / LENS 1502.14101 84122332 DX-SX RH-LH</p>
 <p>cm 16</p>	<p>F-L Euro 6 / F-M 4 / F-H 4</p> <p>FANALE POSTERIORE REAR-LIGHT LED - 24V - CONNETTORE LATERALE AMP 1.5 LED - 24V - LATERAL CONNECTOR AMP 1.5</p> <p>COS.PEL. ref. 1502.14006 SIMILAR ref. 82483073 / 84441760 DX RH Con cicalino / With buzzer - Relativo connettore 003120</p> <p>1502.14005 82483074 / 84441759 SX LH Con luce targa / With plate light - Relativo connettore 003120</p> <p>TRASPARENTE / LENS 1502.14101 84122332 DX-SX RH-LH</p>
 <p>cm 16</p>	<p>F-M vers.2 / F-H vers.2</p> <p>FANALE POSTERIORE REAR-LIGHT CON CICALINO WITH BUZZER</p> <p>COS.PEL. ref. 006008 SIMILAR ref. 21097450 DX RH Con cicalino / With buzzer - conn. 003120</p> <p>TRASPARENTE / LENS 010080 20425732 / 20910229 DX-SX RH-LH</p>
 <p>cm 15</p>	<p>F-M vers.2 / F-H vers.2</p> <p>FANALE POSTERIORE REAR-LIGHT 7 FUNZIONI 7 FUNCTIONS</p> <p>COS.PEL. ref. 006012 SIMILAR ref. 20507624 / 20892384 / 21097448 DX RH Relativo connettore 003120</p> <p>006011 20507623 / 20892386 / 21097449 SX LH Con luce targa / With plate light - conn. 003120</p> <p>TRASPARENTE / LENS 010080 20425732 / 20910229 DX-SX RH-LH</p>
 <p>cm 16</p>	<p>F-M 4 / F-H 2008 / F-H 4</p> <p>FANALE POSTERIORE REAR-LIGHT LED - 24V - CONNETTORE LATERALE AMP 1.5 LED - 24V - LATERAL CONNECTOR AMP 1.5</p> <p>COS.PEL. ref. 1502.14000 SIMILAR ref. 82849923 / 84195521 / 84441768 DX RH Relativo connettore 003120</p> <p>1502.14001 82849894 / 84195505 / 84441766 SX LH Con luce targa / With plate light - Relativo connettore 003120</p> <p>TRASPARENTE / LENS 1502.14100 82849905 DX-SX RH-LH</p>
 <p>cm 16</p>	<p>F-M 4 / F-H 2008 / F-H 4</p> <p>FANALE POSTERIORE REAR-LIGHT LED - 24V - CONNETTORE LATERALE AMP 1.5 LED - 24V - LATERAL CONNECTOR AMP 1.5</p> <p>COS.PEL. ref. 1502.14002 SIMILAR ref. 82849925 / 84195519 / 84441767 DX RH Con cicalino / With buzzer - Relativo connettore 003120</p> <p>TRASPARENTE / LENS 1502.14100 82849905 DX-SX RH-LH</p>
 <p>cm 16</p>	<p>F 10-12-16</p> <p>FANALE POSTERIORE REAR-LIGHT</p> <p>COS.PEL. ref. 005880 SIMILAR ref. 8191748 DX RH</p> <p>005890 8191747 SX LH Con luce targa / With plate light</p> <p>TRASPARENTE / LENS 011111 8142919 DX-SX RH-LH</p>



 <p>cm 16</p>	<p>F-H</p> <p>FANALE POSTERIORE REAR-LIGHT 7 FUNZIONI 7 FUNCTIONS</p> <p>COS.PEL. ref. 006000 SIMILAR ref. 3981456 DX RH Relativo connettore 003120</p> <p>006010 3981455 SX LH Con luce targa / With plate light - conn. 003120</p> <p>TRASPARENTE / LENS 011211 3981782 DX-SX RH-LH</p>
<p>AD ESAURIMENTO SCORTE UNTIL SELL-OUT</p>  <p>cm 16</p>	<p>F-H vers.2</p> <p>FANALE POSTERIORE REAR-LIGHT LED</p> <p>COS.PEL. ref. 006007 SIMILAR ref. - SX LH Con luce targa / With plate light - conn. 003120</p> <p>TRASPARENTE / LENS 011117 - DX-SX RH-LH</p>
 <p>cm 16</p>	<p>F-H vers.2</p> <p>FANALE POSTERIORE REAR-LIGHT 7 FUNZIONI 7 FUNCTIONS</p> <p>COS.PEL. ref. 006014 SIMILAR ref. 20565104 / 21063895 DX RH Con cicalino / With buzzer - conn. 003120</p> <p>006013 20565103 / 21063887 SX LH Con luce targa / With plate light - conn. 003120</p> <p>TRASPARENTE / LENS 010081 20565107 DX-SX RH-LH</p>
 <p>15,2 cm</p>	<p>F-H vers.2</p> <p>FANALE POSTERIORE REAR-LIGHT LED - 24V - CONNETTORE POSTERIORE AMP 1.5 LED - 24V - REAR CONNECTOR AMP 1.5</p> <p>COS.PEL. ref. 1500.00000 SIMILAR ref. - DX RH Relativo connettore multipolare 003120</p> <p>1500.00001 - SX LH Relativo connettore multipolare 003120</p> <p>TRASPARENTE / LENS</p>

Fari posteriori Rear lightings



PARTI DI RICAMBIO ADATTABILI A :
SPARE PARTS SUITABLE TO : COS.SCA

	<p>R - CP/CR 114-124-144-164/CR - R/CR - R 2010/Sca 2017</p> <p>FANALE POSTERIORE REAR-LIGHT CONNETTORE LATERALE AMP 1.5 LATERAL CONNECTOR AMP 1.5</p> <p>COS.PEL. ref. SIMILAR ref. 1503.45006 1756751 / 2021575 / 2129987 DX RH (ex 005722) - Relativo connettore 003120 1503.45007 1756754 / 2021579 / 2129985 SX LH Con luce targa / With plate light (ex 005721) - Connettore 003120</p> <p>TRASPARENTE / LENS 1503.45102 1784670 / 2129991 ex 011212/009212 DX RH 1503.45103 1784669 / 2129992 ex 011213/009213 SX LH</p>
	<p>R - CP/CR 114-124-144-164/CR - R/CR - R 2010/Sca 2017</p> <p>FANALE POSTERIORE REAR-LIGHT CONNETTORE LATERALE AMP 1.5 LATERAL CONNECTOR AMP 1.5</p> <p>COS.PEL. ref. SIMILAR ref. 1503.45008 1791369 / 2021576 / 2129988 DX RH Con cicalino / With buzzer (ex 005724) - Connettore 003120 1503.45009 2021578 / 2129986 SX LH Senza luce targa / W-O Plate light - Connettore 003120</p> <p>TRASPARENTE / LENS 1503.45102 1784670 / 2129991 ex 011212/009212 DX RH 1503.45103 1784669 / 2129992 ex 011213/009213 SX LH</p>
	<p>CR 142 - CR 143 Top Line</p> <p>FANALE POSTERIORE REAR-LIGHT</p> <p>COS.PEL. ref. SIMILAR ref. 005920 1350340 DX RH</p> <p>005930 1350339 SX LH Con luce targa / With plate light</p> <p>TRASPARENTE / LENS 011111 1350343 DX-SX RH-LH</p>
	<p>CR 114-124-144-164</p> <p>FANALE POSTERIORE REAR-LIGHT 7 FUNZIONI 7 FUNCTIONS</p> <p>COS.PEL. ref. SIMILAR ref. 005720 1504609 DX RH</p> <p>005730 1504608 SX LH Con luce targa / With plate light</p> <p>TRASPARENTE / LENS 011211 1380819 DX-SX RH-LH</p>
	<p>CR 114-124-144-164</p> <p>FANALE POSTERIORE REAR-LIGHT</p> <p>COS.PEL. ref. SIMILAR ref. 005726 1508184 DX RH</p> <p>005725 1508182 SX LH Con luce targa / With plate light</p> <p>TRASPARENTE / LENS 011214 1412392 DX-SX RH-LH</p>
	<p>CR 114-124-144-164/CR - R/CR - R 2010/Nuovo Streamline</p> <p>FANALE POSTERIORE REAR-LIGHT LED - 24V - CONNETTORE POSTERIORE AMP 1.5 LED - 24V - REAR CONNECTOR AMP 1.5</p> <p>COS.PEL. ref. SIMILAR ref. 1500.00000 - DX RH - Relativo connettore multipolare 003120 1500.00001 - SX LH - Relativo connettore multipolare 003120</p> <p>TRASPARENTE / LENS</p>
	<p>CR 114-124-144-164/CR - R/CR - R 2010/Nuovo Streamline/Sca 2017</p> <p>FANALE POSTERIORE REAR-LIGHT LED - 24V - CONNETTORE POSTERIORE AMP 1.5 LED - 24V - REAR CONNECTOR AMP 1.5</p> <p>COS.PEL. ref. SIMILAR ref. 1503.45000 - DX RH - Relativo connettore 003120 1503.45001 - SX LH - Relativo connettore 003120</p> <p>TRASPARENTE / LENS 1503.45100 - DX RH 1503.45101 - SX LH</p>
	<p>CR 114-124-144-164/CR - R/CR - R 2010/Nuovo Streamline/Sca 2017</p> <p>FANALE POSTERIORE REAR-LIGHT LED - 24V - CONNETTORE LATERALE AMP 1.5 LED - 24V - LATERAL CONNECTOR AMP 1.5</p> <p>COS.PEL. ref. SIMILAR ref. 1503.45002 - DX RH - Relativo connettore 003120 1503.45003 - SX LH - Relativo connettore 003120</p> <p>TRASPARENTE / LENS 1503.45100 - DX RH 1503.45101 - SX LH</p>



 <p>cm 15,1</p>	<p>CR 114-124-144-164/CR - R/CR - R 2010/Nuovo Streamline/Sca 2017</p> <p>FANALE POSTERIORE REAR-LIGHT LED - 24V - CONNETTORE LATERALE AMP 1.5 LED - 24V - LATERAL CONNECTOR AMP 1.5</p> <p>COS.PEL. ref. SIMILAR ref. 1503.45005 - Con luce targa / With plate light - Relativo connettore 003120 SX LH</p> <p>TRASPARENTE / LENS 1503.45101 - SX LH</p>
<p>AD ESAURIMENTO SCORTE UNTIL SELL-OUT</p>  <p>cm 15,3</p>	<p>CR - R</p> <p>FANALE POSTERIORE REAR-LIGHT LED LED</p> <p>COS.PEL. ref. SIMILAR ref. 005727 - Con luce targa / With plate light SX LH</p> <p>TRASPARENTE / LENS 011114 - DX-SX RH-LH</p>
<p>AD ESAURIMENTO SCORTE UNTIL SELL-OUT</p>  <p>cm 15,3</p>	<p>CR - R</p> <p>FANALE POSTERIORE REAR-LIGHT LED LED</p> <p>COS.PEL. ref. SIMILAR ref. 005732 - Relativo connettore 003120 DX RH</p> <p>005731 - Con luce targa / With plate light - Relativo connettore 003120 SX LH</p> <p>TRASPARENTE / LENS 011115 - DX-SX RH-LH</p>
<p>AD ESAURIMENTO SCORTE UNTIL SELL-OUT</p>  <p>cm 15,3</p>	<p>CR - R</p> <p>FANALE POSTERIORE REAR-LIGHT LED LED</p> <p>COS.PEL. ref. SIMILAR ref. 005734 - Relativo connettore 003120 DX RH</p> <p>005733 - Con luce targa / With plate light SX LH</p> <p>TRASPARENTE / LENS 011115 - DX-SX RH-LH</p>
 <p>cm 15,2</p>	<p>CR - R</p> <p>FANALE POSTERIORE REAR-LIGHT LED LED</p> <p>COS.PEL. ref. SIMILAR ref. 005932 - 005931 - Con luce targa / With plate light DX RH SX LH</p> <p>TRASPARENTE / LENS 011112 - DX-SX RH-LH</p>
 <p>cm 15,3</p>	<p>CR - R</p> <p>FANALE POSTERIORE REAR-LIGHT 7 FUNZIONI - SENZA PIN CENTRALE 7 FUNCTIONS - W/O CENTRAL PIN</p> <p>COS.PEL. ref. SIMILAR ref. 009480 1498103 DX RH</p> <p>009490 1498102 SX LH Con luce targa / With plate light</p> <p>TRASPARENTE / LENS 011211 1380819 DX-SX RH-LH</p>
 <p>cm 15,2</p>	<p>CR - R</p> <p>FANALE POSTERIORE REAR-LIGHT 7 FUNZIONI - CON PIN CENTRALE 7 FUNCTIONS - WITH CENTRAL PIN</p> <p>COS.PEL. ref. SIMILAR ref. 1503.45010 1792374 DX RH</p> <p>1503.45011 1792375 SX LH Con luce targa / With plate light</p> <p>TRASPARENTE / LENS 011211 1380819 DX-SX RH-LH</p>

Fari posteriori Rear lightings



PARTI DI RICAMBIO ADATTABILI A :
SPARE PARTS SUITABLE TO : COS.DA

 <p>cm 15,2</p>	<p>LF 45/55/CF</p> <p>FANALE POSTERIORE REAR-LIGHT 5 FUNZIONI - CONNETTORE POSTERIORE AMP 1.5 5 FUNCTIONS - REAR CONNECTOR AMP 1.5</p> <p>COS.PEL. ref. 1501.03000 SIMILAR ref. 1401731 DX RH (ex 007880/007900) - Connettore 003120</p> <p>1501.03001 1401713 SX LH Con luce targa / W. plate light (ex 007880/007900) - Conn. 003120</p> <p>TRASPARENTE / LENS 1501.03100 1451482 (ex 011591) DX-SX RH-LH</p>
 <p>15,2 cm</p>	<p>CF/CF Euro 6/XF 95 1aSerie XF 95 2aSerie</p> <p>FANALE POSTERIORE REAR-LIGHT LED - 24V - CONNETTORE POSTERIORE AMP 1.5 LED - 24V - REAR CONNECTOR AMP 1.5</p> <p>COS.PEL. ref. 1500.00000 SIMILAR ref. - DX RH Relativo connettore multipolare 003120</p> <p>1500.00001 - SX LH Relativo connettore multipolare 003120</p> <p>TRASPARENTE / LENS</p>
 <p>cm 16</p>	<p>CF Euro 6/XF 106</p> <p>FANALE POSTERIORE REAR-LIGHT CONNETTORE LATERALE HDSCS LATERAL CONNECTOR HDSCS</p> <p>COS.PEL. ref. 1504.10600 SIMILAR ref. 1875576 DX RH (ex 001060) - Relativo connettore 003119</p> <p>1504.10601 1875577 SX LH (ex 001061) Con luce targa / With plate light - Connettore 003119</p> <p>TRASPARENTE / LENS 1504.10680 1914691 (ex 016000) DX RH 1504.10681 1914690 (ex 016001) SX LH</p>
 <p>cm 16</p>	<p>CF Euro 6/XF 106</p> <p>FANALE POSTERIORE REAR-LIGHT CONNETTORE LATERALE HDSCS LATERAL CONNECTOR HDSCS</p> <p>COS.PEL. ref. 1504.10602 SIMILAR ref. 1875578 DX RH (ex 001062) - Con cicalino / With buzzer - Connettore 003119</p> <p>TRASPARENTE / LENS 1504.10680 1914691 (ex 016000) DX RH</p>
 <p>cm 16</p>	<p>CF Euro 6/XF 106</p> <p>FANALE POSTERIORE REAR-LIGHT CONNETTORE POSTERIORE HDSCS REAR CONNECTOR HDSCS</p> <p>COS.PEL. ref. 1504.10604 SIMILAR ref. 1875579 DX RH Relativo connettore 003119</p> <p>1504.10603 1875580 SX LH Con luce targa / With plate light - Relativo connettore 003119</p> <p>TRASPARENTE / LENS 1504.10680 1914691 (ex 016000) DX RH 1504.10681 1914690 (ex 016001) SX LH</p>
 <p>cm 16</p>	<p>CF Euro 6/XF 106</p> <p>FANALE POSTERIORE REAR-LIGHT CONNETTORE POSTERIORE HDSCS REAR CONNECTOR HDSCS</p> <p>COS.PEL. ref. 1504.10606 SIMILAR ref. 1875581 DX RH Con cicalino / With buzzer - Relativo connettore 003119</p> <p>TRASPARENTE / LENS 1504.10680 1914691 (ex 016000) DX RH</p>
 <p>cm 15,3</p>	<p>95</p> <p>FANALE POSTERIORE REAR-LIGHT 7 FUNZIONI 7 FUNCTIONS</p> <p>COS.PEL. ref. 005900 SIMILAR ref. 1284212 DX RH</p> <p>005910 1284211 SX LH Con luce targa / With plate light</p> <p>TRASPARENTE / LENS 011111 1272653 DX-SX RH-LH</p>
 <p>cm 15,5</p>	<p>XF 95 1aSerie XF 95 2aSerie</p> <p>FANALE POSTERIORE REAR-LIGHT 7 FUNZIONI 7 FUNCTIONS</p> <p>COS.PEL. ref. 006120 SIMILAR ref. 1625986 DX RH Relativo connettore 003120</p> <p>006130 1625985 SX LH Con luce targa / With plate light - conn. 003120</p> <p>TRASPARENTE / LENS 011111 1272653 DX-SX RH-LH</p>



	<p>XF 95 1aSerie XF 95 2aSerie</p> <p>FANALE POSTERIORE REAR-LIGHT 7 FUNZIONI 7 FUNCTIONS</p> <p>COS.PEL. ref. 1504.10500 SIMILAR ref. 1625986 Relativo connettore 003120</p> <p>1504.10501 1625985 Con luce targa / With plate light - conn. 003120</p> <p>TRASPARENTE / LENS 011111 1272653</p> <p>DX RH SX LH DX-SX RH-LH</p>
	<p>XF 95 1aSerie XF 95 2aSerie/XF 105/XF 106</p> <p>FANALE POSTERIORE REAR-LIGHT LED - 24V - CONNETTORE LATERALE HDSCS LED - 24V - LATERAL CONNECTOR HDSCS</p> <p>COS.PEL. ref. 1504.10608 SIMILAR ref. - Relativo connettore 003119</p> <p>1504.10607 - Con luce targa / With plate light - Relativo connettore 003119</p> <p>TRASPARENTE / LENS 1503.45100 - 1503.45101 -</p> <p>DX RH SX LH DX RH SX LH</p>
	<p>XF 95 1aSerie XF 95 2aSerie/XF 105/XF 106</p> <p>FANALE POSTERIORE REAR-LIGHT LED - 24V - CONNETTORE POSTERIORE HDSCS LED - 24V - REAR CONNECTOR HDSCS</p> <p>COS.PEL. ref. 1504.10610 SIMILAR ref. - Relativo connettore 003119</p> <p>1504.10609 - Con luce targa / With plate light - Relativo connettore 003119</p> <p>TRASPARENTE / LENS 1503.45100 - 1503.45101 -</p> <p>DX RH SX LH DX RH SX LH</p>
	<p>XF 105</p> <p>FANALE POSTERIORE REAR-LIGHT LED LED</p> <p>COS.PEL. ref. 006132 SIMILAR ref. - Relativo connettore 003120</p> <p>006133 - Con luce targa / With plate light - conn. 003120</p> <p>TRASPARENTE / LENS 011112 -</p> <p>DX RH SX LH DX-SX RH-LH</p>

Fari posteriori Rear lightings



PARTI DI RICAMBIO ADATTABILI A :
SPARE PARTS SUITABLE TO : **COS.ME**

	<p>Sprinter 2000</p> <p>FANALE POSTERIORE REAR-LIGHT 7 FUNZIONI / 7 FUNCTIONS</p> <p>COS.PEL. ref. 005740 SIMILAR ref. A0025445403 DX RH</p> <p>005750 A0025445503 SX LH Con luce targa / With plate light</p> <p>TRASPARENTE / LENS 011241 A0025444790 DX-SX RH-LH</p>
	<p>Sprinter 2000</p> <p>FANALE POSTERIORE REAR-LIGHT SENZA PORTALAMPADA / WITHOUT LAMPHOLDER</p> <p>COS.PEL. ref. 009120 SIMILAR ref. A0008261656 DX RH Portalampada / Lampholder : 009122</p> <p>009121 A0008261556 SX LH Portalampada / Lampholder : 009122</p> <p>TRASPARENTE / LENS</p>
	<p>Sprinter 2000</p> <p>PORTALAMPADA LAMP BULB HOLDER</p> <p>COS.PEL. ref. 009122 SIMILAR ref. - Per lampada / For lamp : 009120 / 009121</p> <p>TRASPARENTE / LENS</p>
	<p>Sprinter 2006/Sprinter 2014</p> <p>FANALE POSTERIORE REAR-LIGHT SENZA PORTALAMPADA / WITHOUT LAMPHOLDER</p> <p>COS.PEL. ref. 009210 SIMILAR ref. A9068200264 DX RH</p> <p>009211 A9068200164 SX LH</p> <p>TRASPARENTE / LENS</p>
	<p>Sprinter 2006/Sprinter 2014</p> <p>FANALE POSTERIORE REAR-LIGHT LED - CONNETTORE POSTERIORE AMP 1.5 / LED - REAR CONNECTOR AMP 1.5</p> <p>COS.PEL. ref. 1505.92000 SIMILAR ref. A9068201764 DX RH (ex 009208) - Relativo connettore 003120</p> <p>1505.92001 A9068200464 SX LH (ex 009209) - Relativo connettore 003120</p> <p>TRASPARENTE / LENS 1503.45102 A008262156 ex 011212/009212 DX RH 1503.45103 A008262056 ex 011213/009213 SX LH</p>
	<p>Atego</p> <p>FANALE POSTERIORE REAR-LIGHT 7 FUNZIONI / 7 FUNCTIONS</p> <p>COS.PEL. ref. 005780 SIMILAR ref. A0035445703 DX RH</p> <p>005790 A0035445303 SX LH Con luce targa / With plate light</p> <p>TRASPARENTE / LENS 011241 A0025444790 DX-SX RH-LH</p>
	<p>Cabina 641</p> <p>FANALE POSTERIORE REAR-LIGHT 7 FUNZIONI / 7 FUNCTIONS</p> <p>COS.PEL. ref. 005630 SIMILAR ref. 0015402670 / A0015401470 DX RH Relativo connettore 003120</p> <p>005640 0015402770 / A0015402870 SX LH Con luce targa / With plate light - conn. 003120</p> <p>TRASPARENTE / LENS 011171 A0025440790 DX RH 011181 A0025441290 SX LH</p>
	<p>ActrosMP1/MegaSpaceMP1</p> <p>FANALE POSTERIORE REAR-LIGHT 7 FUNZIONI / 7 FUNCTIONS</p> <p>COS.PEL. ref. 005550 SIMILAR ref. A0015406370 DX RH Relativo connettore 003120</p> <p>005560 A0015406270 SX LH Con luce targa / With plate light - conn. 003120</p> <p>TRASPARENTE / LENS 011171 A0025440790 DX RH 011181 A0025441290 SX LH</p>



<p>AD ESUBRIMENTO SCORTA UNTIL SELL-OUT</p>  <p>cm 20</p>	<p>ActrosMP1/MegaSpaceMP1</p> <p>FANALE POSTERIORE REAR-LIGHT LED LED</p> <p>COS.PEL. ref. SIMILAR ref.</p> <p>005562 - Relativo connettore 003120 DX RH</p> <p>005561 - Con luce targa / With plate light - conn. 003120 SX LH</p> <p>TRASPARENTE / LENS 011113 - DX-SX RH-LH</p>
 <p>cm 20</p>	<p>ActrosMP1/MegaSpaceMP1</p> <p>FANALE POSTERIORE REAR-LIGHT RIMORCHIO TRAILER</p> <p>COS.PEL. ref. SIMILAR ref.</p> <p>005590 - DX RH</p> <p>005600 - Con luce targa / With plate light SX LH</p> <p>TRASPARENTE / LENS 011191 - DX RH</p> <p>011201 - SX LH</p>
 <p>15,2 cm</p>	<p>ActrosMP1/MegaSpaceMP1/ActrosMP2/MegaSpaceMP2/ActrosMP3/MegaSpaceMP3/BigSpace/GigaSpace/MP4/S.Spa.</p> <p>FANALE POSTERIORE REAR-LIGHT LED - 24V - CONNETTORE POSTERIORE AMP 1.5 LED - 24V - REAR CONNECTOR AMP 1.5</p> <p>COS.PEL. ref. SIMILAR ref.</p> <p>1500.00000 - DX RH</p> <p>1500.00001 - Relativo connettore multipolare 003120 SX LH</p> <p>TRASPARENTE / LENS - Relativo connettore multipolare 003120</p>
 <p>cm 13,8</p>	<p>BigSpace/GigaSpace/MP4/StreamSpace</p> <p>FANALE POSTERIORE REAR-LIGHT</p> <p>COS.PEL. ref. SIMILAR ref.</p> <p>009610 A0035441803 DX RH</p> <p>009611 A0035441703 SX LH</p> <p>TRASPARENTE / LENS 096300 Con luce targa / With plate light A0025447390 DX-SX RH-LH</p>
 <p>cm 13,8</p>	<p>BigSpace/GigaSpace/MP4/StreamSpace</p> <p>FANALE POSTERIORE REAR-LIGHT CON CICALINO WITH BUZZER</p> <p>COS.PEL. ref. SIMILAR ref.</p> <p>009612 - DX RH</p> <p>TRASPARENTE / LENS 096300 A0025447390 DX-SX RH-LH</p>

Fari posteriori Rear lightings



PARTI DI RICAMBIO ADATTABILI A :
SPARE PARTS SUITABLE TO : COS.IVE

	<p>Daily 96</p> <p>FANALE POSTERIORE REAR-LIGHT 5 FUNZIONI / 5 FUNCTIONS</p> <p>COS.PEL. ref. 003970 SIMILAR ref. 1904639 / 1907700 DX RH</p> <p>003980 1904640 / 1907701 SX LH</p> <p>TRASPARENTE / LENS</p> <p>012621 42471138 / 7984015 DX RH</p> <p>012721 42471137 / 7984016 SX LH</p>
	<p>Daily S2000</p> <p>FANALE POSTERIORE REAR-LIGHT 5 FUNZIONI / 5 FUNCTIONS</p> <p>COS.PEL. ref. 008590 SIMILAR ref. 500356782 DX RH</p> <p>008600 500356783 SX LH</p> <p>TRASPARENTE / LENS</p> <p>012621 42471138 / 7984015 DX RH</p> <p>012721 42471137 / 7984016 SX LH</p>
	<p>Daily S2000</p> <p>FANALE POSTERIORE REAR-LIGHT SENZA PORTALAMPADA / WITHOUT LAMPHOLDER</p> <p>COS.PEL. ref. 1606.35930 SIMILAR ref. 500319558 DX RH</p> <p>1606.35931 500319559 SX LH</p> <p>TRASPARENTE / LENS</p>
	<p>Daily 2006</p> <p>FANALE POSTERIORE REAR-LIGHT</p> <p>COS.PEL. ref. 003950 SIMILAR ref. 5801351224 / 581631433 / 69500026 DX RH</p> <p>003951 5801351218 / 581631438 / 69500032 SX LH</p> <p>TRASPARENTE / LENS</p> <p>013901 42555131 / 42555132 DX-SX RH-LH</p>
	<p>Daily 2006</p> <p>FARO POSTERIORE REAR-LIGHT LED - 3 STOP / LED - 3 STOP</p> <p>COS.PEL. ref. 1506.39002 SIMILAR ref. 69500805</p> <p>TRASPARENTE / LENS</p>
	<p>Daily 2006</p> <p>FARO POSTERIORE REAR-LIGHT LED - 3 STOP CON LUCE DI CORTESIA / LED - 3 STOP</p> <p>COS.PEL. ref. 1506.39003 SIMILAR ref. 69500806</p> <p>TRASPARENTE / LENS</p>
	<p>Daily 2006/Daily 2010/Daily 2014</p> <p>FANALE POSTERIORE REAR-LIGHT LED - 12V - Connettore posteriore AMP 1.5 / LED - 12V - Rear connector AMP 1.5</p> <p>COS.PEL. ref. 1500.00004 SIMILAR ref. - DX RH</p> <p>1500.00005 - SX LH</p> <p>TRASPARENTE / LENS</p>
	<p>Daily 2010</p> <p>FANALE POSTERIORE REAR-LIGHT</p> <p>COS.PEL. ref. 1606.41030 SIMILAR ref. 69500590 DX RH</p> <p>1606.41031 69500591 SX LH</p> <p>TRASPARENTE / LENS</p>



	<p>Daily 2014</p> <p>FANALE POSTERIORE REAR-LIGHT 3o Stop Base S2014 - LED 3o STOP - LED</p> <p>COS.PEL. ref. 1506.40601 SIMILAR ref. 5801557592</p> <p>TRASPARENTE / LENS</p>
	<p>Daily 2014</p> <p>FANALE POSTERIORE REAR-LIGHT 3o Stop Medio S2014 - LED - CON LUCE DI CORTESIA 3o STOP - LED</p> <p>COS.PEL. ref. 1506.40602 SIMILAR ref. 5801557593</p> <p>TRASPARENTE / LENS</p>
 	<p>Daily 2014</p> <p>FANALE POSTERIORE REAR-LIGHT</p> <p>COS.PEL. ref. 1606.40606 SIMILAR ref. 5801523221 DX RH</p> <p>1606.40605 5801523220 SX LH</p> <p>TRASPARENTE / LENS</p>
	<p>Eurocargo 60/Eurocargo 120/Eurocargo 150/Eurocargo 75e13/120e21</p> <p>FANALE POSTERIORE REAR-LIGHT 5 FUNZIONI 5 FUNCTIONS</p> <p>COS.PEL. ref. 008550 SIMILAR ref. 500382617 / 98421202 DX RH</p> <p>008560 500382616 / 98421203 SX LH</p> <p>TRASPARENTE / LENS 012621 42471138 / 7984015 DX RH 012721 42471137 / 7984016 SX LH</p>
	<p>Eurocargo 2009 75e13/120e18/Eurocargo 2009 120e21/180e28/Eurocargo 75-2015/Eurocargo 130-2015/Stralis AD/AT/AS</p> <p>FANALE POSTERIORE REAR-LIGHT LED - 24V - CONNETTORE POSTERIORE AMP 1.5 LED - 24V - REAR CONNECTOR AMP 1.5</p> <p>COS.PEL. ref. 1500.00000 SIMILAR ref. - DX RH</p> <p>1500.00001 - Relativo connettore multipolare 003120 SX LH</p> <p>TRASPARENTE / LENS - Relativo connettore multipolare 003120</p>
	<p>Eurotech/Eurostar</p> <p>FANALE POSTERIORE REAR-LIGHT 7 FUNZIONI - SENZA LUCE TARGA 7 FUNCTIONS - W/O PLATE LIGHT</p> <p>COS.PEL. ref. 006140 SIMILAR ref. - DX RH</p> <p>006150 - Relativo connettore 003105 SX LH</p> <p>TRASPARENTE / LENS 011111 - DX-SX RH-LH</p>
	<p>Eurotech/Eurostar</p> <p>FANALE POSTERIORE REAR-LIGHT 7 FUNZIONI - SENZA L. TARGA - CON BORDO BIANCO 7 FUNCTIONS - W/O PLATE LIGHT - WITH WHITE EDGE</p> <p>COS.PEL. ref. 006142 SIMILAR ref. 99463242 DX RH</p> <p>006141 Relativo connettore 003105 SX LH</p> <p>TRASPARENTE / LENS 011110 93161844 DX-SX RH-LH</p>
	<p>Eurotech/Eurostar</p> <p>FANALE POSTERIORE REAR-LIGHT 7 FUNZIONI - CON LUCE TARGA - CON BORDO BIANCO 7 FUNCTIONS - WITH PLATE LIGHT - WITH WHITE EDGE</p> <p>COS.PEL. ref. 006143 SIMILAR ref. 99463244 SX LH</p> <p>Con luce targa / With plate light - conn. 003105</p> <p>TRASPARENTE / LENS 011110 93161844 DX-SX RH-LH</p>

Fari posteriori Rear lightings



PARTI DI RICAMBIO ADATTABILI A :
SPARE PARTS SUITABLE TO : COS.IVE

	<p>Eurotech/Eurostar</p> <p>FANALE POSTERIORE REAR-LIGHT LED LED</p> <p>COS.PEL. ref. SIMILAR ref. 006152 - Relativo connettore 003105 DX RH</p> <p>006151 - SX LH</p> <p>TRASPARENTE / LENS Con luce targa / With plate light - conn. 003105 011112 - DX-SX RH-LH</p>
	<p>Eurotech/Eurostar</p> <p>FANALE POSTERIORE REAR-LIGHT 7 FUNZIONI - CON LUCE TARGA 7 FUNCTIONS - WITH PLATE LIGHT</p> <p>COS.PEL. ref. SIMILAR ref. 006880 - Relativo connettore 003105 SX LH</p> <p>TRASPARENTE / LENS 011111 - DX-SX RH-LH</p>
	<p>Nuovo Stralis 2007 AD - AT/Nuovo Stralis 2007 AS/Stralis 2013 HI-WAY - AD/AT/Stralis 2013 HI-WAY - AS</p> <p>FANALE POSTERIORE REAR-LIGHT LED - 24V - CONNETTORE LATERALE HDSCS LED - 24V - LATERAL CONNECTOR HDSCS</p> <p>COS.PEL. ref. SIMILAR ref. 1506.92000 5802000573 Relativo connettore 003119 DX RH</p> <p>1506.92001 5802062689 Relativo connettore 003119 SX LH</p> <p>TRASPARENTE / LENS 1503.45100 - DX RH 1503.45101 - SX LH</p>
	<p>Nuovo Stralis 2007 AD - AT/Nuovo Stralis 2007 AS/Stralis 2013 HI-WAY - AD/AT/Stralis 2013 HI-WAY - AS</p> <p>FANALE POSTERIORE REAR-LIGHT LED - 24V - CONNETTORE LATERALE HDSCS LED - 24V - LATERAL CONNECTOR HDSCS</p> <p>COS.PEL. ref. SIMILAR ref. 1506.92002 5802000767 Con cicalino / With buzzer - Relativo connettore 003119 DX RH</p> <p>1506.92003 5802000568 Con luce targa / With plate light - Relativo connettore 003119 SX LH</p> <p>TRASPARENTE / LENS 1503.45100 - DX RH 1503.45101 - SX LH</p>
	<p>Nuovo Stralis 2007 AD - AT/Nuovo Stralis 2007 AS/Stralis 2013 HI-WAY - AD/AT/Stralis 2013 HI-WAY - AS</p> <p>FANALE POSTERIORE REAR-LIGHT LED - 24V - CONNETTORE POSTERIORE HDSCS LED - 24V - REAR CONNECTOR HDSCS</p> <p>COS.PEL. ref. SIMILAR ref. 1506.92004 5802000770 Relativo connettore 003119 DX RH</p> <p>1506.92005 5802000570 Relativo connettore 003119 SX LH</p> <p>TRASPARENTE / LENS 1503.45100 - DX RH 1503.45101 - SX LH</p>
	<p>Nuovo Stralis 2007 AD - AT/Nuovo Stralis 2007 AS/Stralis 2013 HI-WAY - AD/AT/Stralis 2013 HI-WAY - AS</p> <p>FANALE POSTERIORE REAR-LIGHT LED - 24V - CONNETTORE POSTERIORE HDSCS LED - 24V - REAR CONNECTOR HDSCS</p> <p>COS.PEL. ref. SIMILAR ref. 1506.92006 5802000772 Con cicalino / With buzzer - Relativo connettore 003119 DX RH</p> <p>1506.92007 5802055273 Con luce targa / With plate light - Relativo connettore 003119 SX LH</p> <p>TRASPARENTE / LENS 1503.45100 - DX RH 1503.45101 - SX LH</p>
	<p>Stralis 2013 HI-WAY - AD/AT/Stralis 2013 HI-WAY - AS</p> <p>FANALE POSTERIORE REAR-LIGHT Interasse tra le viti 15,3 cm Inter-axis 15,3 cm</p> <p>COS.PEL. ref. SIMILAR ref. 006154 5801363431 DX RH</p> <p>006153 5801363428 SX LH</p> <p>TRASPARENTE / LENS 011110 93161844 DX-SX RH-LH</p>
	<p>Stralis 2013 HI-WAY - AD/AT/Stralis 2013 HI-WAY - AS</p> <p>FANALE POSTERIORE REAR-LIGHT Interasse tra le viti 15,3 cm Inter-axis 15,3 cm</p> <p>COS.PEL. ref. SIMILAR ref. 006155 5801363432 DX RH</p> <p>006157 - SX LH</p> <p>TRASPARENTE / LENS Con Cicalino / With Buzzer Con luce targa / With plate light 011110 93161844 DX-SX RH-LH</p>



	<p>Stralis 2013 HI-WAY - AD/AT/Stralis 2013 HI-WAY - AS</p> <p>FANALE POSTERIORE REAR-LIGHT 24V - CONNETTORE LATERALE HDSCS 24V - SIDE CONNECTOR HDSCS</p> <p>COS.PEL. ref. 1506.92008 SIMILAR ref. 5801637201 DX RH Relativo connettore 003119</p> <p>1506.92009 5801637199 SX LH Con luce targa / With plate light - Relativo connettore 003119</p> <p>TRASPARENTE / LENS 1506.92100 42575877 DX RH 1506.92101 42575315 SX LH</p>
	<p>Stralis 2013 HI-WAY - AD/AT/Stralis 2013 HI-WAY - AS</p> <p>FANALE POSTERIORE REAR-LIGHT 24V - CONNETTORE LATERALE HDSCS 24V - SIDE CONNECTOR HDSCS</p> <p>COS.PEL. ref. 1506.92010 SIMILAR ref. 5801637202 DX RH Con cicalino / With buzzer - Relativo connettore 003119</p> <p>TRASPARENTE / LENS 1506.92100 42575877 DX RH</p>
	<p>Stralis 2013 HI-WAY - AD/AT/Stralis 2013 HI-WAY - AS</p> <p>FANALE POSTERIORE REAR-LIGHT 24V - CONNETTORE POSTERIORE HDSCS 24V - REAR CONNECTOR HDSCS</p> <p>COS.PEL. ref. 1506.92012 SIMILAR ref. 5801757328 DX RH Relativo connettore 003119</p> <p>1506.92011 5801637182 SX LH Relativo connettore 003119</p> <p>TRASPARENTE / LENS 1506.92100 42575877 DX RH 1506.92101 42575315 SX LH</p>
	<p>Stralis 2013 HI-WAY - AD/AT/Stralis 2013 HI-WAY - AS</p> <p>FANALE POSTERIORE REAR-LIGHT 24V - CONNETTORE POSTERIORE HDSCS 24V - REAR CONNECTOR HDSCS</p> <p>COS.PEL. ref. 1506.92014 SIMILAR ref. 5801757326 DX RH Con cicalino / With buzzer - Relativo connettore 003119</p> <p>1506.92013 5802055272 SX LH Con luce targa / With plate light - Relativo connettore 003119</p> <p>TRASPARENTE / LENS 1506.92100 42575877 DX RH 1506.92101 42575315 SX LH</p>

Fari posteriori Rear lightings



PARTI DI RICAMBIO ADATTABILI A :
SPARE PARTS SUITABLE TO : COS.MA

	<p>TGL/10-12/TGL Euro 6/TGM Euro 6/TGA LX/TGA XL/XXL/TGX/TGX Euro 6</p> <p>FANALE POSTERIORE REAR-LIGHT CONNETTORE LATERALE AMP 1.5 LATERAL CONNECTOR AMP 1.5</p> <p>COS.PEL. ref. 1507.10000 SIMILAR ref. 8125225-6545 DX RH (ex 009214) - Relativo connettore 003120 1507.10001 8125225-6544 SX LH (ex 009215) - Relativo connettore 003120</p> <p>TRASPARENTE / LENS 1507.10100 8125229-6060 (ex 011012) DX RH 1507.10101 8125229-6059 (ex 011011) SX LH</p>
	<p>TGL/10-12/TGL Euro 6/TGM Euro 6/TGA LX/TGA XL/XXL/TGX/TGX Euro 6</p> <p>FANALE POSTERIORE REAR-LIGHT CONNETTORE LATERALE AMP 1.5 LATERAL CONNECTOR AMP 1.5</p> <p>COS.PEL. ref. 1507.10002 SIMILAR ref. 8125225-6547 DX RH Con cicalino / With buzzer (ex 009216) - Connettore 003120</p> <p>TRASPARENTE / LENS 1507.10100 8125229-6060 (ex 011012) DX RH</p>
	<p>F 2000</p> <p>FANALE POSTERIORE REAR-LIGHT 7 FUNZIONI 7 FUNCTIONS</p> <p>COS.PEL. ref. 006120 SIMILAR ref. 81252286028 DX RH Relativo connettore 003120 006130 81252286027 SX LH Con luce targa / With plate light - conn. 003120</p> <p>TRASPARENTE / LENS 011111 81252296055 DX-SX RH-LH</p>
	<p>F 2000</p> <p>FANALE POSTERIORE REAR-LIGHT 7 FUNZIONI 7 FUNCTIONS</p> <p>COS.PEL. ref. 1504.10500 SIMILAR ref. 81252286028 DX RH Relativo connettore 003120 1504.10501 81252286027 SX LH Con luce targa / With plate light - conn. 003120</p> <p>TRASPARENTE / LENS 011111 81252296055 DX-SX RH-LH</p>
	<p>TGA XL/XXL</p> <p>FANALE POSTERIORE REAR-LIGHT LED LED</p> <p>COS.PEL. ref. 006132 SIMILAR ref. - DX RH Relativo connettore 003120 006133 - SX LH Con luce targa / With plate light - conn. 003120</p> <p>TRASPARENTE / LENS 011112 - DX-SX RH-LH</p>
	<p>TGA XL/XXL/TGS</p> <p>FANALE POSTERIORE REAR-LIGHT LED - 24V - CONNETTORE POSTERIORE AMP 1.5 LED - 24V - REAR CONNECTOR AMP 1.5</p> <p>COS.PEL. ref. 1500.00000 SIMILAR ref. - DX RH Relativo connettore multipolare 003120 1500.00001 - SX LH Relativo connettore multipolare 003120</p> <p>TRASPARENTE / LENS</p>



Fari posteriori Rear lightings

Altri veicoli / Other vehicles

<p>AD ESAURIMENTO SCORTE UNTIL SELL-OUT</p> 	<p>COS.FOR Transit 86-90</p> <p>FANALE POSTERIORE REAR-LIGHT</p> <p>COS.PEL. ref. 009906 SIMILAR ref. 4505431 DX RH</p> <p>009907 4505432 SX LH</p> <p>TRASPARENTE / LENS</p>
--	---

Fari posteriori Rear lightings

Universali / Universal



<p>AD ESAURIMENTO SCORTE UNTIL SELL-OUT</p> 	<p>Universali / Universal</p> <p>FARO POSTERIORE REAR-LIGHT LED - TRS.3F.LED 24V (CE) C/A LED - TRS.3F.LED 24V (CE) C/A</p> <p>COS.PEL. ref. SIMILAR ref. 002997 -</p> <p>TRASPARENTE / LENS</p>
<p>AD ESAURIMENTO SCORTE UNTIL SELL-OUT</p> 	<p>Universali / Universal</p> <p>FARO POSTERIORE REAR-LIGHT LED LED</p> <p>COS.PEL. ref. SIMILAR ref. 003046 -</p> <p>TRASPARENTE / LENS</p>
<p>AD ESAURIMENTO SCORTE UNTIL SELL-OUT</p>  <p>cm 15,2</p>	<p>Universali / Universal</p> <p>FANALE POSTERIORE REAR-LIGHT 7 FUNZIONI - SENZA CONNETTORE 7 FUNCTIONS - WITHOUT CONNECTOR</p> <p>COS.PEL. ref. SIMILAR ref. 005660 -</p> <p>005670 -</p> <p>TRASPARENTE / LENS CON LUCE TARGA / WITH PLATE LIGHT 011111 -</p> <p>DX RH SX LH DX-SX RH-LH</p>
<p>AD ESAURIMENTO SCORTE UNTIL SELL-OUT</p>  <p>cm 15,2</p>	<p>Universali / Universal</p> <p>FANALE POSTERIORE REAR-LIGHT SENZA CONNETTORE - CON LUCE TARGA WITHOUT CONNECTOR - WITH PLATE LIGHT</p> <p>COS.PEL. ref. SIMILAR ref. 007900 -</p> <p>TRASPARENTE / LENS 1501.03100 -</p> <p>(ex 011591) DX-SX RH-LH</p>
<p>AD ESAURIMENTO SCORTE UNTIL SELL-OUT</p>  <p>cm 19</p>	<p>Universali / Universal</p> <p>FANALE POSTERIORE REAR-LIGHT 5 FUNZIONI - SENZA CONNETTORE 5 FUNCTIONS - WITHOUT CONNECTOR</p> <p>COS.PEL. ref. SIMILAR ref. 009170 -</p> <p>009180 -</p> <p>TRASPARENTE / LENS 012621 - 012721 -</p> <p>DX RH SX LH DX RH SX LH</p>
<p>AD ESAURIMENTO SCORTE UNTIL SELL-OUT</p>  <p>cm 16</p>	<p>Universali / Universal</p> <p>FANALE POSTERIORE REAR-LIGHT FULL-LED RELATIVO CONNETTORE 003118 ELECTRICAL JOINT 003118</p> <p>COS.PEL. ref. SIMILAR ref. 009700 -</p> <p>009701 -</p> <p>TRASPARENTE / LENS Con luce targa / With plate light - conn.003120 011701 -</p> <p>DX RH SX LH DX-SX RH-LH</p>
<p>AD ESAURIMENTO SCORTE UNTIL SELL-OUT</p>  <p>cm 16</p>	<p>Universali / Universal</p> <p>FANALE POSTERIORE REAR-LIGHT FULL-LED - RELATIVO CONNETTORE 003118 FULL-LED - ELECTRICAL JOINT 003118</p> <p>COS.PEL. ref. SIMILAR ref. 009702 -</p> <p>Con cicalino / With Buzzer - conn. 003120</p> <p>TRASPARENTE / LENS 011701 -</p> <p>DX RH DX-SX RH-LH</p>
<p>AD ESAURIMENTO SCORTE UNTIL SELL-OUT</p>  <p>15,2 cm</p>	<p>Universali / Universal</p> <p>FANALE POSTERIORE REAR-LIGHT LED - 24V - CONNETTORE POSTERIORE AMP 1.5 LED - 24V - REAR CONNECTOR AMP 1.5</p> <p>COS.PEL. ref. SIMILAR ref. 1500.00000 -</p> <p>1500.00001 -</p> <p>TRASPARENTE / LENS Relativo connettore multipolare 003120</p> <p>DX RH SX LH</p>



	<p>Universali / Universal</p> <p>FANALE POSTERIORE REAR-LIGHT LED - 12V - Connettore posteriore AMP 1.5 LED - 12V - Rear connector AMP 1.5</p> <p>COS.PEL. ref. SIMILAR ref. 1500.00004 - - Relativo connettore multipolare 003120 DX RH 1500.00005 - - Relativo connettore multipolare 003120 SX LH</p> <p>TRASPARENTE / LENS</p>
	<p>Universali / Universal</p> <p>FANALE POSTERIORE REAR-LIGHT 12/24V - CONNETTORE POSTERIORE LED - 12/24V - REAR CONNECTOR</p> <p>COS.PEL. ref. SIMILAR ref. 1500.00008 -</p> <p>TRASPARENTE / LENS</p>
	<p>Universali / Universal</p> <p>FANALE POSTERIORE REAR-LIGHT LED - 12/24V - CONNETTORE POSTERIORE LED - 12/24V - REAR CONNECTOR</p> <p>COS.PEL. ref. SIMILAR ref. 1500.00009 -</p> <p>TRASPARENTE / LENS</p>
	<p>Universali / Universal</p> <p>FANALE POSTERIORE REAR-LIGHT LED - CONNETTORE POSTERIORE - 12/24V LED - REAR CONNECTOR - 12/24V</p> <p>COS.PEL. ref. SIMILAR ref. 1500.00010 -</p> <p>TRASPARENTE / LENS</p>

Fari posteriori Rear lightings

Rimorchi / Trailers



	<p>Rimorchi / Trailers</p> <p>FANALE POSTERIORE REAR-LIGHT RIMORCHIO - SENZA CONNETTORE TRAILER - WITHOUT CONNECTOR</p> <p>COS.PEL. ref. SIMILAR ref.</p> <p>005260 - DX RH</p> <p>005270 - SX LH</p> <p>TRASPARENTE / LENS Con luce targa / With plate light</p> <p>011091 - DX RH</p> <p>011101 - SX LH</p>
	<p>Rimorchi / Trailers</p> <p>FANALE POSTERIORE REAR-LIGHT RIMORCHIO TRAILER</p> <p>COS.PEL. ref. SIMILAR ref.</p> <p>005590 - DX RH</p> <p>005600 - SX LH</p> <p>TRASPARENTE / LENS Con luce targa / With plate light</p> <p>011191 - DX RH</p> <p>011201 - SX LH</p>
	<p>Rimorchi / Trailers</p> <p>FANALE POSTERIORE REAR-LIGHT RIMORCHIO - SENZA CONNETTORE TRAILER - WITHOUT CONNECTOR</p> <p>COS.PEL. ref. SIMILAR ref.</p> <p>005710 - DX RH</p> <p>005440 - SX LH</p> <p>TRASPARENTE / LENS Con luce targa / With plate light</p> <p>011271 - DX RH</p> <p>011281 - SX LH</p>
<p>AD ESAURIMENTO SCORTE UNTIL SELL-OUT</p>	<p>Rimorchi / Trailers</p> <p>FANALE POSTERIORE REAR-LIGHT LED - RIMORCHIO - CON CATADIOTTRO LED - TRAILER - WITH REFLECTOR</p> <p>COS.PEL. ref. SIMILAR ref.</p> <p>005735 - SX LH</p> <p>Con luce targa / With plate light - conn. 003120</p> <p>TRASPARENTE / LENS</p> <p>011115 - DX-SX RH-LH</p>
	<p>Rimorchi / Trailers</p> <p>FANALE POSTERIORE REAR-LIGHT RIMORCHIO TRAILER</p> <p>COS.PEL. ref. SIMILAR ref.</p> <p>007010 - DX RH</p> <p>- Relativo connettore 003116</p> <p>007011 - SX LH</p> <p>TRASPARENTE / LENS Relativo connettore 003116</p> <p>011700 - DX-SX RH-LH</p>
<p>AD ESAURIMENTO SCORTE UNTIL SELL-OUT</p>	<p>Rimorchi / Trailers</p> <p>FANALE POSTERIORE REAR-LIGHT RIMORCHIO TRAILER</p> <p>COS.PEL. ref. SIMILAR ref.</p> <p>008010 - DX RH</p> <p>008011 - SX LH</p> <p>TRASPARENTE / LENS Con luce targa / With plate light</p> <p>011118 - DX RH</p> <p>011119 - SX LH</p>
<p>AD ESAURIMENTO SCORTE UNTIL SELL-OUT</p>	<p>Rimorchi / Trailers</p> <p>FANALE POSTERIORE REAR-LIGHT RIMORCHIO TRAILER</p> <p>COS.PEL. ref. SIMILAR ref.</p> <p>008012 - DX RH</p> <p>008013 - SX LH</p> <p>TRASPARENTE / LENS Con luce targa / With plate light</p> <p>011118 - DX RH</p> <p>011119 - SX LH</p>
	<p>Rimorchi / Trailers</p> <p>FANALE POSTERIORE REAR-LIGHT RIMORCHIO - SENZA CONNETTORE TRAILER - WITHOUT CONNECTOR</p> <p>COS.PEL. ref. SIMILAR ref.</p> <p>008290 - DX RH</p> <p>- Con luce targa / With plate light</p> <p>008300 - SX LH</p> <p>TRASPARENTE / LENS Con luce targa / With plate light</p> <p>011641 - DX-SX RH-LH</p>



 <p>cm 15,2</p>	<p>Rimorchi / Trailers</p> <p>FANALE POSTERIORE REAR-LIGHT RIMORCHIO - CON CONNETTORE TRAILER - WITH CONNECTOR</p> <p>COS.PEL. ref. SIMILAR ref.</p> <p>008310 - Con luce targa / With plate light - conn. 003116 DX RH</p> <p>008320 - Con luce targa / With plate light - conn. 003116 SX LH</p> <p>TRASPARENTE / LENS</p> <p>011641 - DX-SX RH-LH</p>
 <p>cm 15,2</p>	<p>Rimorchi / Trailers</p> <p>FANALE POSTERIORE REAR-LIGHT RIMORCHIO - LED - 24V - Connettore posteriore AMP 1.5 TRAILER - LED - 24V - Rear connector AMP 1.5</p> <p>COS.PEL. ref. SIMILAR ref.</p> <p>1500.00002 - Relativo connettore multipolare 003120 DX RH</p> <p>1500.00003 - Relativo connettore multipolare 003120 SX LH</p> <p>TRASPARENTE / LENS</p>
 <p>cm 15,2</p>	<p>Rimorchi / Trailers</p> <p>FANALE POSTERIORE REAR-LIGHT RIMORCHIO - CONNETTORE POSTERIORE AMP 1.5 TRAILER - REAR CONNECTOR AMP 1.5</p> <p>COS.PEL. ref. SIMILAR ref.</p> <p>1500.00006 - Relativo connettore 003120 DX RH</p> <p>1500.00007 - Relativo connettore multipolare 003120 SX LH</p> <p>TRASPARENTE / LENS</p> <p>1500.00100 - DX RH</p> <p>1500.00101 - SX LH</p>

Fari posteriori Rear lightings

Luci targa / Number plate lights



	<p>Luci targa / Number plate lights</p> <p>FANALINO LUCE TARGA UNIVERSALE NUMBER PLATE LIGTH UNIVERSAL COS.PEL. ref. SIMILAR ref. 000860 -</p>
	<p>Luci targa / Number plate lights</p> <p>FANALINO LUCE TARGA UNIVERSALE NUMBER PLATE LIGTH UNIVERSAL COS.PEL. ref. SIMILAR ref. 000862 -</p> <p>000861 -</p> <p style="text-align: right;">DX RH</p> <p style="text-align: right;">SX LH</p>
	<p>Luci targa / Number plate lights</p> <p>FANALINO LUCE TARGA UNIVERSALE NUMBER PLATE LIGTH UNIVERSAL COS.PEL. ref. SIMILAR ref. 000864 -</p> <p>000863 -</p> <p style="text-align: right;">DX RH</p> <p style="text-align: right;">SX LH</p>
	<p>Luci targa / Number plate lights</p> <p>FANALINO LUCE TARGA LED - UNIVERSALE - 24 Volt NUMBER PLATE LIGTH LED - UNIVERSAL - 24 Volt COS.PEL. ref. SIMILAR ref. 000865 -</p> <p style="text-align: right;">24 Volt</p>
	<p>Luci targa / Number plate lights</p> <p>FANALINO LUCE TARGA LED - UNIVERSALE - 24 Volt NUMBER PLATE LIGTH LED - UNIVERSAL - 24 Volt COS.PEL. ref. SIMILAR ref. 000866 -</p> <p style="text-align: right;">24 Volt</p>
	<p>Luci targa / Number plate lights</p> <p>FANALINO LUCE TARGA LED - UNIVERSALE - 24 Volt NUMBER PLATE LIGTH LED - UNIVERSAL - 24 Volt COS.PEL. ref. SIMILAR ref. 000867 -</p> <p style="text-align: right;">24 Volt</p>
	<p>Luci targa / Number plate lights</p> <p>FANALINO LUCE TARGA LED - UNIVERSALE - 24 Volt NUMBER PLATE LIGTH LED - UNIVERSAL - 24 Volt COS.PEL. ref. SIMILAR ref. 000868 -</p> <p style="text-align: right;">24 Volt</p>



	<p>Connessioni elettriche / Electrical joints</p> <p>BUZZER PIEZOELETTRICO Multitensione intermittente. 6/28Vcc - 90 dB PIEZOELECTRIC BUZZER Intermittent multi-voltage. 6/28Vdc - 90 dB COS.PEL. ref. SIMILAR ref. 003090 -</p>
	<p>Connessioni elettriche / Electrical joints</p> <p>AVVISATORE ACUSTICO DI RETROMARCIA Con cavi volanti di lunghezza standard di 300 mm BACK-UP ALARM With free wiring with standard 300 mm. length COS.PEL. ref. SIMILAR ref. 003091 -</p>
	<p>Connessioni elettriche / Electrical joints</p> <p>CICALINO DI RETROMARCIA LC8 destra Cicalino di retromarcia - 24V - 90db BUZZER LC8 right buzzer - 24V - 90db COS.PEL. ref. SIMILAR ref. 003092 - 003092 1973239</p>
	<p>Connessioni elettriche / Electrical joints</p> <p>KIT PER CONNESSIONI ELETTRICHE 1 Connet. stagno Tyco "Superseal" 2 vie Porta Femm., 2 Term., 2 Gommini KIT FOR ELECTRICAL JOINTS 1 Watertight Connector Tyco "Superseal" 2 ways Female Holder, 2 Term., 2 Rubber tops COS.PEL. ref. SIMILAR ref. 003100 -</p>
	<p>Connessioni elettriche / Electrical joints</p> <p>KIT PER CONNESSIONI ELETTRICHE 1 Connet. stagno Tyco "Superseal" 3 vie Porta Femm., 3 Term., 3 Gommini KIT FOR ELECTRICAL JOINTS 1 Watertight Connector Tyco "Superseal" 3 ways Female Holder, 3 Term., 3 Rubber tops COS.PEL. ref. SIMILAR ref. 003101 -</p>
	<p>Connessioni elettriche / Electrical joints</p> <p>KIT PER CONNESSIONI ELETTRICHE 1 Connet. stagno Tyco "Superseal" 2 vie Porta Masc., 2 Term., 2 Gommini KIT FOR ELECTRICAL JOINTS 1 Watertight Connector Tyco "Superseal" 2 ways Male Holder, 2 Term., 2 Rubber tops, COS.PEL. ref. SIMILAR ref. 003102 -</p>
	<p>Connessioni elettriche / Electrical joints</p> <p>KIT PER CONNESSIONI ELETTRICHE 1 Connet. stagno Tyco "Superseal" 3 vie Porta Masc., 3 Term., 3 Gommini KIT FOR ELECTRICAL JOINTS 1 Watertight Connector Tyco "Superseal" 3 ways Male Holder, 3 Term., 3 Rubber tops COS.PEL. ref. SIMILAR ref. 003103 -</p>
	<p>Connessioni elettriche / Electrical joints</p> <p>KIT PER CONNESSIONI ELETTRICHE 1 Connettore stagno MIC 3 vie Porta Femmina, 3 Terminali, 3 Gommini pressacavo KIT FOR ELECTRICAL JOINTS 1 Watertight Connector MIC 3 ways Female Holder, 3 Terminals, 3 Rubber tops COS.PEL. ref. SIMILAR ref. 003104 -</p>

	<p>Connessioni elettriche / Electrical joints</p> <p>KIT PER CONNESSIONI ELETTRICHE KIT FOR ELECTRICAL JOINTS 1 Connettore stagno MIC, 10 vie Porta Femmina, 10 Terminali, 10 Gommini pressacavo 1 Watertight Connector MIC, 10 ways Female Holder, 10 Terminals, 10 Rubber tops COS.PEL. ref. SIMILAR ref. 003105 -</p>
	<p>Connessioni elettriche / Electrical joints</p> <p>KIT PER CONNESSIONI ELETTRICHE KIT FOR ELECTRICAL JOINTS 1 Connettore stagno MIC, 3 vie Porta Maschio, 3 Terminali, 3 Gommini pressacavo 1 Watertight Connector MIC, 3 ways Male Holder, 3 Terminals, 3 Rubber tops COS.PEL. ref. SIMILAR ref. 003106 -</p>
	<p>Connessioni elettriche / Electrical joints</p> <p>KIT PER CONNESSIONI ELETTRICHE KIT FOR ELECTRICAL JOINTS 1 Connettore stagno MIC, 10 vie Porta Maschio, 10 Terminali, 10 Gommini pressacavo 1 Watertight Connector MIC, 10 ways Male Holder, 10 Terminals, 10 Rubber tops COS.PEL. ref. SIMILAR ref. 003107 -</p>
	<p>Connessioni elettriche / Electrical joints</p> <p>KIT PER CONNESSIONI ELETTRICHE KIT FOR ELECTRICAL JOINTS 1 Connettore circolare stagno 2 vie Porta Femmina, 2 Terminali, 2 Gommini pressacavo 1 Round Watertight Connector 2 ways Female Holder, 2 Terminals, 2 Rubber tops COS.PEL. ref. SIMILAR ref. 003108 -</p>
	<p>Connessioni elettriche / Electrical joints</p> <p>KIT PER CONNESSIONI ELETTRICHE KIT FOR ELECTRICAL JOINTS 1 Connettore cilindrico non stagno 7 vie, 7 Terminali lamellari "X8" per interf. Matrice-Rimorchio 1 Cylindric not-watertight Connector 7 ways, 7 lamellar terminals "X8" for interf. Truck/Trailer COS.PEL. ref. SIMILAR ref. 003109 -</p>
	<p>Connessioni elettriche / Electrical joints</p> <p>KIT PER CONNESSIONI ELETTRICHE KIT FOR ELECTRICAL JOINTS 1 Connettore stagno Deutsch 2 vie Porta Femmina, 2 Terminali, 1 Piastrine di fissaggio 1 Watertight connector Deutsch 2 ways Female Holder, 2 Terminals, 1 Fastening plates COS.PEL. ref. SIMILAR ref. 003110 -</p>
	<p>Connessioni elettriche / Electrical joints</p> <p>KIT PER CONNESSIONI ELETTRICHE KIT FOR ELECTRICAL JOINTS 1 Connettore stagno Deutsch 3 vie Porta Femmina, 3 Terminali, 1 Piastrina di fissaggio 1 Watertight connector Deutsch 3 ways Female Holder, 3 Terminals, 1 Fastening plate COS.PEL. ref. SIMILAR ref. 003111 -</p>
	<p>Connessioni elettriche / Electrical joints</p> <p>KIT PER CONNESSIONI ELETTRICHE KIT FOR ELECTRICAL JOINTS 1 Connettore stagno Deutsch 6 vie Porta Femmina, 6 Terminali, 1 Piastrina di fissaggio 1 Watertight connector Deutsch 6 ways Female Holder, 6 Term., 1 Fastening plate COS.PEL. ref. SIMILAR ref. 003112 -</p>

	<p>Connessioni elettriche / Electrical joints</p> <p>KIT PER CONNESSIONI ELETTRICHE 1 Connettore stagno Deutsch 2 vie Porta Maschio, 2 Terminali, 1 Piastrina di fissaggio KIT FOR ELECTRICAL JOINTS 1 Watertight connector Deutsch 2 ways Male Holder, 2 Terminals, 1 Fastening plate COS.PEL. ref. SIMILAR ref. 003113 -</p>
	<p>Connessioni elettriche / Electrical joints</p> <p>KIT PER CONNESSIONI ELETTRICHE 1 Connettore stagno Deutsch 3 vie Porta Maschio, 3 Terminali, 1 Piastrina di fissaggio KIT FOR ELECTRICAL JOINTS 1 Watertight connector Deutsch 3 ways Male Holder, 3 Terminals, 1 Fastening plate COS.PEL. ref. SIMILAR ref. 003114 -</p>
	<p>Connessioni elettriche / Electrical joints</p> <p>KIT PER CONNESSIONI ELETTRICHE 1 Connettore stagno Deutsch 6 vie Porta Maschio, 6 Terminali, 1 Piastrina di fissaggio KIT FOR ELECTRICAL JOINTS 1 Watertight connector Deutsch 6 ways Male Holder, 6 Term., 1 Fastening plate COS.PEL. ref. SIMILAR ref. 003115 -</p>
	<p>Connessioni elettriche / Electrical joints</p> <p>KIT PER CONNESSIONI ELETTRICHE 1 conn. stagno +1 ghiera filettata +1 isolante gomma +1 fascetta reg. +7 termin. +1 chius.gomma KIT FOR ELECTRICAL JOINTS 1 sealed conn. +1 threaded plast. ring +1 insulat.rubber +1 adjust. clip +7 cont. +1 rubb.cap COS.PEL. ref. SIMILAR ref. 003116 -</p>
	<p>Connessioni elettriche / Electrical joints</p> <p>KIT PER CONNESSIONI ELETTRICHE 1 conn.circ.stagno 2 vie ghiera (per fan.targa cos.ive) +2 corpi di protezione: 90 e dir. +2 term. KIT FOR ELECTRICAL JOINTS 1 sealed circ conn. 2 way fem.w.nut (for cos.ive nu.pl.lights) +2 prot.housing: 90 an rig. +2 prot. COS.PEL. ref. SIMILAR ref. 003117 -</p>
	<p>Connessioni elettriche / Electrical joints</p> <p>KIT PER CONNESSIONI ELETTRICHE Kit: 1 conn.stagno 7 vie c.ghiera (per fan.post. cos.ive) +2 corpi di prot.: 90 e diritto +7 term. KIT FOR ELECTRICAL JOINTS Kit: 1 sealed conn. 7 ways with nut (for cos.ive rear lights) +2 prot.housi.: 90 and right +7 term. COS.PEL. ref. SIMILAR ref. 003118 -</p>
	<p>Connessioni elettriche / Electrical joints</p> <p>KIT PER CONNESSIONI ELETTRICHE Connettore HDSCS singolo KIT FOR ELECTRICAL JOINTS Connector HDSCS simple COS.PEL. ref. SIMILAR ref. 003119 -</p>
	<p>Connessioni elettriche / Electrical joints</p> <p>KIT PER CONNESSIONI ELETTRICHE Connettore AMP 1,5 singolo KIT FOR ELECTRICAL JOINTS Connector AMP 1,5 simple COS.PEL. ref. SIMILAR ref. 003120 -</p>

Fari posteriori Rear lightings

Connessioni elettriche / Electrical joints



	<p>Connessioni elettriche / Electrical joints</p> <p>KIT PER CONNESSIONI ELETTRICHE Connettore 3 vie JPT KIT FOR ELECTRICAL JOINTS Connector 3 ways JPT COS.PEL. ref. 003121 SIMILAR ref. - Connettore per 1601.50015</p>
	<p>Connessioni elettriche / Electrical joints</p> <p>KIT PER CONNESSIONI ELETTRICHE Connettore 2 vie JPT KIT FOR ELECTRICAL JOINTS Connector 2 ways JPT COS.PEL. ref. 003122 SIMILAR ref. - Connettore per 003001 - 003003 - 003004</p>
	<p>Connessioni elettriche / Electrical joints</p> <p>KIT PER CONNESSIONI ELETTRICHE Connettore SUPERSEAL 2 vie femmina KIT FOR ELECTRICAL JOINTS Connector SUPERSEAL 2 ways female COS.PEL. ref. 003123 SIMILAR ref. - Connettore per la serie 1500.xxxxx</p>











Parti di ricambio adattabili a:
Spare parts suitable to:

Segnalatori Beacons



PARTI DI RICAMBIO ADATTABILI A :
SPARE PARTS SUITABLE TO : **COS.RE**

 	<p>Master 1999</p> <p>FANALINO LATERALE P21W CORNER LAMP P21W COS.PEL. ref. 1601.00002 SIMILAR ref. 7701044523 DX RH</p> <p>1601.00003 7701044522 SX LH</p>
 	<p>Master 1999</p> <p>FANALINO LATERALE P21W CORNER LAMP P21W COS.PEL. ref. 1601.00004 SIMILAR ref. 7700353947 DX RH</p> <p>1601.00005 7700353946 SX LH</p>
 	<p>Master 2003</p> <p>FANALINO LATERALE PY21W CORNER LAMP PY21W COS.PEL. ref. 1601.03802 SIMILAR ref. 8200163918 DX RH</p> <p>1601.03803 8200163914 SX LH</p>
 	<p>Master 2003</p> <p>FANALINO LATERALE PY21W CORNER LAMP PY21W COS.PEL. ref. 1601.03804 SIMILAR ref. 8200263364 DX RH</p> <p>1601.03805 8200263356 SX LH</p>
	<p>Midlum/Premium</p> <p>PORTALAMPADA Relativo connettore 003121 LAMP BULB HOLDER Related connector 003121 COS.PEL. ref. 1601.50015 SIMILAR ref. 5001834568</p> <p>Per lampada / For lamp : 1601.50018 / 1604.55001</p>
 	<p>Midlum/Premium</p> <p>FANALINO LATERALE R5W SIDE LAMP R5W COS.PEL. ref. 1601.50018 SIMILAR ref. 5001834565 / 7421103284 DX-SX RH-LH</p> <p>Portalampada/Lamp holder : 1601.50015</p>
  	<p>Premium</p> <p>FANALE LATERALE LAMPADINA ATTACCO AMP - JPT - Relativo connettore 003122 SIDE LAMP BULB CONNECTION AMP - JPT - Related connector 003122 COS.PEL. ref. 003001 SIMILAR ref. 5010306792 / 7484538758 DX-SX RH-LH</p> <p>ARANCIO / ORANGE - Relativo portalampada 1601.50013</p>
  	<p>Premium</p> <p>FANALE LATERALE LAMPADINA ATTACCO AMP-JPT - W5W - Relativo connettore 003122 SIDE LAMP BULB CONNECTION AMP-JPT - W5W - Relativo connettore 003122 COS.PEL. ref. 003003 SIMILAR ref. 5001862030 DX-SX RH-LH</p> <p>BIANCO / WHITE - Relativo portalampada 1601.50013</p>



	<p>Premium</p> <p>FANALE LATERALE LED 4 LED - 12 / 24 Volt - Relativo connettore 003122 SIDE LAMP LED 4 LED - 12 / 24 Volt - Relativo connettore 003122 COS.PEL. ref. SIMILAR ref. 003004 -</p> <p style="text-align: right;">DX-SX RH-LH</p> <p style="text-align: center;">BIANCO / WHITE (12/24 V) - Relativo portalamпада 1601.50013</p>
	<p>Premium</p> <p>PORTALAMPADA Relativo connettore 003122 (JPT) LAMP BULB HOLDER Related connector 003122 (JPT) COS.PEL. ref. SIMILAR ref. 1601.50013 5001847589</p> <p style="text-align: center;">Per lampada / For lamp : 003001 / 003003 / 003004</p>
	<p>Premium</p> <p>PORTALAMPADA Relativo connettore 003122 LAMP BULB HOLDER Related connector 003122 COS.PEL. ref. SIMILAR ref. 1601.50014 5001834564</p> <p style="text-align: center;">Per lampada / For lamp : 1601.50021/2</p>
 	<p>Premium</p> <p>INDICATORE DIREZIONE P21W DIRECTION INDICATOR P21W COS.PEL. ref. SIMILAR ref. 1601.50022 5001834559</p> <p style="text-align: right;">DX RH</p> <p>1601.50021 5001834560 Portalampada/Lamp holder : 1601.50014</p> <p style="text-align: right;">SX LH</p> <p style="text-align: center;">Portalampada/Lamp holder : 1601.50014</p>
 	<p>Nuovo Premium</p> <p>FANALINO LATERALE CORNER LAMP COS.PEL. ref. SIMILAR ref. 1601.50025 5001834561</p> <p style="text-align: right;">DX-SX RH-LH</p>
 	<p>AE - Magnum</p> <p>FANALINO LATERALE P21W CORNER LAMP P21W COS.PEL. ref. SIMILAR ref. 1601.23604 5010271807</p> <p style="text-align: right;">DX-SX RH-LH</p>

Segnalatori Beacons



PARTI DI RICAMBIO ADATTABILI A : COS.VO
SPARE PARTS SUITABLE TO :

	<p>F-E 2006</p> <p>PORTALAMPADA Relativo connettore 003121 LAMP BULB HOLDER Related connector 003121 COS.PEL. ref. 1601.50015 SIMILAR ref. 20745227 Per lampada / For lamp : 1601.50018 / 1604.55001</p>
 	<p>F-E 2006</p> <p>FANALINO LATERALE R5W SIDE LAMP R5W COS.PEL. ref. 1601.50018 SIMILAR ref. 21103284 Portalampada/Lamp holder : 1601.50015</p> <p style="text-align: right;">DX-SX RH-LH</p>
	<p>F-M vers.2/F-H 2008</p> <p>FANALINO INGOMBRO CABINA LED 2 LED - 24V - LUCE BIANCA DRIVER'S CAB SIDE MARKER LED 2 LED - 24V COS.PEL. ref. 1602.13811 SIMILAR ref. 82116545</p> <p style="text-align: right;">DX-SX RH-LH</p>
	<p>F-M 4/F-H 4</p> <p>FANALINO LATERALE LED SIDE LAMP LED COS.PEL. ref. 1602.14810 SIMILAR ref. 82151205 1602.14809 82151157</p> <p style="text-align: right;">DX RH SX LH</p>
 	<p>F 10-12-16</p> <p>FANALINO CORNER LAMP COS.PEL. ref. 1602.93924 SIMILAR ref. 1593924 1602.93923 1593923</p> <p style="text-align: right;">DX RH SX LH</p>
 	<p>F-H</p> <p>FANALINO LATERALE R5W - 3 PIN SIDE LAMP R5W - 3 PIN COS.PEL. ref. 1602.81666 SIMILAR ref. 3981666 / 8191142</p> <p style="text-align: right;">DX-SX RH-LH</p>
 	<p>F-H</p> <p>FANALINO P21W/W5W - BICOLORE - 3 PIN CORNER LAMP P21W/W5W - DOUBLE COLOUR - 3 PIN COS.PEL. ref. 1602.81668 SIMILAR ref. 3981668</p> <p style="text-align: right;">DX-SX RH-LH</p>
 	<p>F-H vers.2</p> <p>FANALE LATERALE LED 4 LED - 12 / 24 Volt SIDE LAMP LED 4 LED - 12 / 24 Volt COS.PEL. ref. 003000 SIMILAR ref. 20398660 / 20789440 ARANCIO / ORANGE (12/24 V)</p> <p style="text-align: right;">DX-SX RH-LH</p>



	<p>F-H vers.2</p> <p>FANALE LATERALE LAMPADINA ATTACCO AMP - JPT - Relativo connettore 003122 SIDE LAMP BULB CONNECTION AMP - JPT - Related connector 003122 COS.PEL. ref. 003001 SIMILAR ref. 20734485</p> <p style="text-align: right;">DX-SX RH-LH</p> <p style="text-align: center;">ARANCIO / ORANGE - Relativo portalampada 1601.50013</p>
	<p>F-H vers.2</p> <p>FANALE LATERALE LED 4 LED - ATTACCO AMP-JPT - 12 / 24 Volt SIDE LAMP LED 4 LED - CONNECTION AMP-JPT - 12 / 24 Volt COS.PEL. ref. 003002 SIMILAR ref. -</p> <p style="text-align: right;">DX-SX RH-LH</p> <p style="text-align: center;">ARANCIO / ORANGE (12/24 V)</p>
	<p>F-H vers.2</p> <p>BASE FANALINO CENTRALE R5W CENTRAL BASIC R5W COS.PEL. ref. 1602.61658 SIMILAR ref. 20425484</p>
	<p>F-H vers.2</p> <p>BASE FANALINO LATERALE R5W LATERAL BASIC R5W COS.PEL. ref. 1602.61659 SIMILAR ref. 20398824</p> <p style="text-align: right;">DX-SX RH-LH</p>
	<p>F-H vers.2</p> <p>LENTE BIANCA WHITE LENS COS.PEL. ref. 1602.61660 SIMILAR ref. 1623726</p> <p style="text-align: right;">DX-SX RH-LH</p>
	<p>F-H vers.2</p> <p>LENTE ARANCIONE AMBER LENS COS.PEL. ref. 1602.61661 SIMILAR ref. 1623727</p> <p style="text-align: right;">DX-SX RH-LH</p>
	<p>F-H vers.2</p> <p>ADATTATORE ELETTRICO PER FARI MANUALI 9 PIN HEAD LAMP ADAPTER 9 PIN COS.PEL. ref. 1602.61662 SIMILAR ref. -</p>
	<p>F-H vers.2</p> <p>FANALINO H21W CORNER LAMP H21W COS.PEL. ref. 1602.61670 SIMILAR ref. 20409875 / 20826213</p> <p style="text-align: right;">DX RH</p> <p>1602.61669 20409874 / 20826211 SX LH</p>

Segnalatori Beacons



PARTI DI RICAMBIO ADATTABILI A : COS.VO
SPARE PARTS SUITABLE TO :

	<p>F-H vers.2</p> <p>ADATTATORE ELETTRICO PER FARO ELETTRICO 12 PIN HEAD LAMP ADAPTER 12 PIN COS.PEL. ref. 1602.61671 SIMILAR ref. -</p>
	<p>F-H 2008</p> <p>LUCCIOLA LED CORNER LAMP LED COS.PEL. ref. 1602.13804 SIMILAR ref. 82114500 DX RH</p> <p>1602.13805 82114506 SX LH</p>
<p>AD ESAURIMENTO SCORTE UNTIL SELL-OUT</p> 	<p>F-H 2008</p> <p>CABLAGGIO ELETTRICO BULB HOLDER COS.PEL. ref. 1602.13806 SIMILAR ref. 82078418</p>
	<p>F-H 2008</p> <p>FANALINO INGOMBRO CABINA LED 2 LED - 24V - ARANCIONE DRIVER'S CAB SIDE MARKER LED 2 LED - 24V - AMBER COS.PEL. ref. 1602.13812 SIMILAR ref. 21087346 DX-SX RH-LH</p>
	<p>F-H 2008</p> <p>FANALINO INGOMBRO CABINA LED 2 LED - 24V - VERDE DRIVER'S CAB SIDE MARKER LED 2 LED - 24V - GREEN COS.PEL. ref. 1602.13813 SIMILAR ref. 21087347 DX-SX RH-LH</p>
	<p>F-H 4</p> <p>FANALINO LATERALE LED LED CORNER LAMP LED LED COS.PEL. ref. 1602.14812 SIMILAR ref. 21346522 DX RH</p> <p>1602.14811 21346521 SX LH</p>







	<p>CR 114-124-144-164</p> <p>FANALE LATERALE LED 4 LED - 12 / 24 Volt SIDE LAMP LED 4 LED - 12 / 24 Volt COS.PEL. ref. 003006</p> <p>SIMILAR ref. 1391144 / 1443884 / 1471599</p> <p>ARANCIO / ORANGE (12/24 V)</p> <p>DX-SX RH-LH</p>
	<p>CR 114-124-144-164</p> <p>CABLAGGIO ELETTRICO BULB HOLDER</p> <p>COS.PEL. ref. 1603.85412</p> <p>SIMILAR ref. 1732515</p>
 	<p>CR 114-124-144-164</p> <p>FANALINO P21W R5W BICOLORE CORNER LAMP P21W R5W DOUBLE COLOUR COS.PEL. ref. 1603.87150</p> <p>SIMILAR ref. 1349784 / 1387155</p> <p>DX RH</p> <p>1603.85411 1349783 / 1385410</p> <p>SX LH</p>
<p>AD ESAURIMENTO SCORTE UNTIL SELL-OUT</p> 	<p>CR 114-124-144-164/CR - R</p> <p>CATADIOTTRO MARKER WITH REFLEX-REFLECTOR</p> <p>COS.PEL. ref. 1603.44707</p> <p>SIMILAR ref. 1362707 / 2052117</p> <p>DX-SX RH-LH</p>
	<p>CR - R</p> <p>FANALE LATERALE 3 LED DX-SX 3 LED - 12 / 24 Volt SIDE MARKER 3 LED 3 LED - 12 / 24 Volt COS.PEL. ref. 002999</p> <p>SIMILAR ref. 1737413 / 2000390 / 2080828</p> <p>ARANCIO / ORANGE (12/24 V)</p> <p>DX-SX RH-LH</p>
 	<p>CR - R</p> <p>FRECCIA P21W LED SIDE LAMP P21W LED COS.PEL. ref. 1603.45524</p> <p>SIMILAR ref. 1747981 / 2442689</p> <p>DX-SX RH-LH</p>
 	<p>CR - R</p> <p>FANALINO LATERALE P21W CORNER LAMP P21W COS.PEL. ref. 1603.45525</p> <p>SIMILAR ref. 1770301 / 2052103</p> <p>DX-SX RH-LH</p>
	<p>CR - R</p> <p>FANALINO VISIERA LED 4 LED VISOR LAMP LED 4 LED COS.PEL. ref. 1603.45526</p> <p>SIMILAR ref. 1798980 / 1910437</p>



Segnalatori Beacons



PARTI DI RICAMBIO ADATTABILI A : COS.SCA
SPARE PARTS SUITABLE TO :

 	<p>CR - R</p> <p>FRECCIA LED LED - P21W 24V - BASE CROMATA LED SIDE LAMP LED - P21W 24V - CHROME BASE COS.PEL. ref. SIMILAR ref. 1603.45531 1949900</p> <p style="text-align: right;">DX-SX RH-LH</p>
	<p>CR - R</p> <p>LUCE DI POSIZIONE LED LED DAYTIME LIGHT LED LED COS.PEL. ref. SIMILAR ref. 1603.45532 1931614 / 2031055 / 2127432</p> <p style="text-align: right;">DX RH</p> <p>1603.45533 1931613 / 2031054 / 2127431 SX LH</p>
	<p>CR - R</p> <p>FRECCIA LED LED - BASE NERA LED SIDE LAMP LED - BLACK BASE COS.PEL. ref. SIMILAR ref. 1603.45534 2241544 / 2442637</p> <p style="text-align: right;">DX-SX RH-LH</p>
 	<p>CR - R/CR - R 2010/Nuovo Streamline</p> <p>FANALINO LATERALE 24V CORNER LAMP 24V COS.PEL. ref. SIMILAR ref. 1603.45535 1928063 / 2083830</p> <p style="text-align: right;">DX-SX RH-LH</p>
	<p>Sca 2017</p> <p>FANALINO LED 4 LED CORNER LAMP LED 4 LED COS.PEL. ref. SIMILAR ref. 1603.48606 2334728</p> <p style="text-align: right;">DX RH</p> <p>1603.48607 2334727 SX LH</p>



	<p>LF 45/55</p> <p>PORTALAMPADA Relativo connettore 003121 LAMP BULB HOLDER Related connector 003121 COS.PEL. ref. 1601.50015 SIMILAR ref. 1626102</p> <p>Per lampada / For lamp : 1601.50018 / 1604.55001</p>
 	<p>LF 45/55</p> <p>FANALINO LATERALE R5W CORNER LAMP R5W COS.PEL. ref. 1604.55001 SIMILAR ref. 1626101</p> <p>DX-SX RH-LH</p> <p>Relativo portalampada/Lamp holder : 1601.50015</p>
	<p>LF 45/55/CF</p> <p>PORTALAMPADA Relativo connettore 003122 (JPT) LAMP BULB HOLDER Related connector 003122 (JPT) COS.PEL. ref. 1601.50013 SIMILAR ref. 1608352</p> <p>Per lampada / For lamp : 003001 / 003003 / 003004</p>
  	<p>LF 45/55/CF/XF 95 1aSerie XF 95 2aSerie/XF 105</p> <p>FANALE LATERALE LAMPADINA ATTACCO AMP - JPT - Relativo connettore 003122 SIDE LAMP BULB CONNECTION AMP - JPT - Related connector 003122 COS.PEL. ref. 003001 SIMILAR ref. 1303892 / 1329718</p> <p>DX-SX RH-LH</p> <p>ARANCIO / ORANGE - Relativo portalampada 1601.50013</p>
 	<p>CF</p> <p>FANALE LATERALE LAMPADINA ATTACCO AMP-JPT - W5W - Relativo connettore 003122 SIDE LAMP BULB CONNECTION AMP-JPT - W5W - Relativo connettore 003122 COS.PEL. ref. 003003 SIMILAR ref. 1653605</p> <p>DX-SX RH-LH</p> <p>BIANCO / WHITE - Relativo portalampada 1601.50013</p>
	<p>CF/XF 95 1aSerie XF 95 2aSerie/XF 105</p> <p>FANALINO LATERALE P21W CORNER LAMP P21W COS.PEL. ref. 1604.10588 SIMILAR ref. 1395361 / 1735355 / 1814096</p> <p>DX-SX RH-LH</p>
 	<p>CF Euro 6/XF 106</p> <p>LUCE DI DIREZIONE P21YW SIDE LAMP P21YW COS.PEL. ref. 1604.10604 SIMILAR ref. 1846492</p> <p>DX RH</p> <p>1604.10605 Portalampada / Bulb holder : 1606.92810 1846491 SX LH</p> <p>Portalampada / Bulb holder : 1606.92810</p>









Segnalatori Beacons



PARTI DI RICAMBIO ADATTABILI A :
SPARE PARTS SUITABLE TO : **COS.ME**

 	<p>Sprinter 2006</p> <p>INDICATORE DIREZIONE DIRECTION INDICATOR</p> <p>COS.PEL. ref. 1605.92610 SIMILAR ref. 0018229020 + 0008201277 DX RH</p> <p>1605.92611 0018229320 + 0008201277 SX LH</p>
 	<p>Atego</p> <p>FANALINO LATERALE P21W CORNER LAMP P21W</p> <p>COS.PEL. ref. 1605.97300 SIMILAR ref. 9738200421 DX RH</p> <p>1605.97301 9738200321 SX LH</p>
 	<p>Atego</p> <p>FANALINO ANTERIORE PY21W CORNER LAMP PY21W</p> <p>COS.PEL. ref. 1605.97302 SIMILAR ref. 9738200621 DX RH</p> <p>1605.97303 9738200521 SX LH</p>
 	<p>Atego</p> <p>LUCE DIREZIONE PY21W CORNER LAMP PY21W</p> <p>COS.PEL. ref. 1605.97310 SIMILAR ref. A9738200221 DX RH</p> <p>1605.97311 A9738200121 SX LH</p>
 	<p>Atego</p> <p>LUCE DIREZIONE 13 -> PY21W/P21W DIRECTION LIGHT 13 -> PY21W/P21W</p> <p>COS.PEL. ref. 1605.97312 SIMILAR ref. 9678200221 DX RH</p> <p>1605.97313 9678200121 SX LH</p>
 	<p>Atego</p> <p>FANALINO LATERALE P21W SIDE LAMP P21W</p> <p>COS.PEL. ref. 1605.97318 SIMILAR ref. 9678201221 DX RH</p> <p>1605.97319 9678201121 SX LH</p>
 	<p>Axor</p> <p>FANALINO PY21W CORNER LAMP PY21W</p> <p>COS.PEL. ref. 1605.94062 SIMILAR ref. 9408200421 DX RH</p> <p>1605.94063 9408200321 SX LH</p>
 	<p>Axor</p> <p>FANALINO P21 5W CORNER LAMP P21 5W</p> <p>COS.PEL. ref. 1605.94064 SIMILAR ref. 0008200777 / 9408200221 DX-SX RH-LH</p> <p>Relativo portalampada 1605.94067</p>



















	<p>Axor</p> <p>PORTALAMPADA</p> <p>BULB HOLDER</p> <p>COS.PEL. ref. 1605.94067 SIMILAR ref. -</p> <p>Per lampada / For lamp : 1605.94064</p>
	<p>ActrosMP1/MegaSpaceMP1</p> <p>FANALE LATERALE LED 6 LED - 12 / 24 Volt</p> <p>SIDE LAMP LED 6 LED - 12 / 24 Volt</p> <p>COS.PEL. ref. 003007 SIMILAR ref. A0005445411 DX-SX RH-LH</p> <p>ARANCIO / ORANGE (12/24 V)</p>
 	<p>ActrosMP1/MegaSpaceMP1</p> <p>FANALINO LATERALE P21 5W - FORNITO SENZA PORTALAMPADA</p> <p>CORNER LAMP P21 5W - WITHOUT SOCKET</p> <p>COS.PEL. ref. 1605.94162 SIMILAR ref. A9418200921 DX RH</p> <p>1605.94163 A9418200521 SX LH</p>
 	<p>ActrosMP1/MegaSpaceMP1</p> <p>FANALINO LATERALE P21W</p> <p>CORNER LAMP P21W</p> <p>COS.PEL. ref. 1605.94166 SIMILAR ref. 9418201321 DX-SX RH-LH</p>
	<p>ActrosMP2/MegaSpaceMP2/ActrosMP3/MegaSpaceMP3</p> <p>FANALINO LUCE DIURNA LED</p> <p>CORNER LAMP LED</p> <p>COS.PEL. ref. 1605.94372 SIMILAR ref. A9438200856 DX RH</p> <p>1605.94373 A9438200756 SX LH</p>
 	<p>BigSpace/GigaSpace/MP4/StreamSpace</p> <p>FANALINO LATERALE P21 5W</p> <p>CORNER LAMP P21 5W</p> <p>COS.PEL. ref. 1605.96110 SIMILAR ref. 9608201121 DX RH</p> <p>1605.96111 9608201021 SX LH</p>

Segnalatori Beacons



PARTI DI RICAMBIO ADATTABILI A :
SPARE PARTS SUITABLE TO : **COS.IVE**

		Daily 96 FANALINO CORNER LAMP COS.PEL. ref. 1606.33912 SIMILAR ref. 98433912 1606.33913 98433913	DX RH SX LH
		Daily S2000 INDICATORE DIREZIONE DIRECTION INDICATOR COS.PEL. ref. 1606.35914 SIMILAR ref. 500320425 / 500320427 1606.35915 500320426 / 500320428	DX RH SX LH
		Daily S2000 FANALINO CORNER LAMP COS.PEL. ref. 1606.35916 SIMILAR ref. 504104467 1606.35917 504104465	DX RH SX LH
		Daily S2000 FANALE LATERALE SIDE LAMP COS.PEL. ref. 1606.35920 SIMILAR ref. 500328136 1606.35921 500328137	DX RH SX LH
		Daily S2000 FANALE LATERALE SIDE LAMP COS.PEL. ref. 1606.35922 SIMILAR ref. 500355252 1606.35923 500355253	DX RH SX LH
		Daily S2000 FANALE LATERALE SIDE LAMP COS.PEL. ref. 1606.35924 SIMILAR ref. 504104575 1606.35925 504104577	DX RH SX LH
		Daily S2000 FANALE LATERALE SIDE LAMP COS.PEL. ref. 1606.35926 SIMILAR ref. 504104580 1606.35927 504104582	DX RH SX LH
		Daily S2000 FANALE INGOMBRO CABINA SIDE MARKER COS.PEL. ref. 1606.35928 SIMILAR ref. 500316961 1606.35929 500316960	DX RH SX LH

















 	<p>Daily 2006</p> <p>FANALINO SU SPECCHIETTO</p> <p>SIDE LAMP</p> <p>COS.PEL. ref. 1606.39202 SIMILAR ref. 3801915 DX RH</p> <p>1606.39203 3801914 SX LH</p>
 	<p>Daily 2014</p> <p>LUCE DIREZIONE</p> <p>SIGNAL LIGHT</p> <p>COS.PEL. ref. 1606.40602 SIMILAR ref. 5801585151 / 5801874639 DX RH</p> <p>1606.40603 5801585146 / 5801874640 SX LH</p> <p><small>Relativo portalampada 1606.40611</small></p>
 	<p>Daily 2014</p> <p>LUCE DIREZIONE</p> <p>SIGNAL LIGHT</p> <p>COS.PEL. ref. 1606.40608 SIMILAR ref. 5801823334 DX RH</p> <p>1606.40607 5801823572 SX LH</p>
 	<p>Daily 2014</p> <p>LUCE INGOMBRO</p> <p>DRIVER CAB. MARKER</p> <p>COS.PEL. ref. 1606.40610 SIMILAR ref. 5801610735 DX RH</p> <p>1606.40609 5801610737 SX LH</p>
	<p>Daily 2014</p> <p>PORTALAMPADA</p> <p>LAMP BULB HOLDER</p> <p>COS.PEL. ref. 1606.40611 SIMILAR ref. -</p> <p><small>Per lampada / For lamp : 1606.40602 / 3</small></p>
 	<p>Eurocargo 60/Eurocargo 120</p> <p>LUCE DIREZIONALE</p> <p>CORNER LAMP</p> <p>COS.PEL. ref. 1606.75916 SIMILAR ref. 500340695 DX RH</p> <p>1606.75917 500340696 SX LH</p>
 	<p>Eurocargo 60/Eurocargo 120</p> <p>FANALINO LATERALE</p> <p>SIDE LAMP</p> <p>COS.PEL. ref. 1606.75918 SIMILAR ref. 4862220 DX-SX RH-LH</p>
 	<p>Eurocargo 60/Eurocargo 120/Eurocargo 150</p> <p>FANALINO LATERALE</p> <p>SIDE LAMP</p> <p>COS.PEL. ref. 1606.75919 SIMILAR ref. 99452662 DX-SX RH-LH</p>













Segnalatori Beacons







PARTI DI RICAMBIO ADATTABILI A :
SPARE PARTS SUITABLE TO : **COS.IVE**



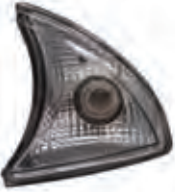

 	<p>Eurocargo 60/Eurocargo 120/Eurotech/Eurostar</p> <p>FANALINO VISIERA NERO - 91 -> SUN VISOR'S MARKER BLACK - 91 -> COS.PEL. ref. 1606.75920 SIMILAR ref. 500314717</p> <p>1606.75921 500314716</p> <p style="text-align: right;">DX RH SX LH</p>
 	<p>Eurocargo 60/Eurocargo 120/Eurotech/Eurostar</p> <p>FANALINO VISIERA ARGENTO - 91 -> SUN VISOR'S MARKER SILVER - 91 -> COS.PEL. ref. 1606.75922 SIMILAR ref. 98461649</p> <p>1606.75923 98461648</p> <p style="text-align: right;">DX RH SX LH</p>
 	<p>Eurocargo 75e13/120e21/Eurocargo 130e24/180e28</p> <p>FANALINO CORNER LAMP</p> <p>COS.PEL. ref. 1606.75600 SIMILAR ref. 504047573</p> <p style="text-align: right;">DX-SX RH-LH</p>
 	<p>Eurocargo 75e13/120e21/Eurocargo 130e24/180e28/Tector 160e18/180e30/Eurocargo 2009 75e13/120e18/Eurocargo 2009 120e21/180e28/Stralis AD/AT/Stralis AS/Nuovo Stralis 2007 AD - AT/Nuovo Stralis 2007 AS</p> <p>FANALINO VISIERA 03 -> SUN VISOR' MARKER 03 -> COS.PEL. ref. 1606.80046 SIMILAR ref. 504047265</p> <p>1606.80047 504047264</p> <p style="text-align: right;">DX RH SX LH</p>
 	<p>Tector 160e18/180e30/Stralis AD/AT/Stralis AS</p> <p>FANALINO INGOMBRO CABINA DRIVER'S CAB SIDE MARKER</p> <p>COS.PEL. ref. 1606.75604 SIMILAR ref. 504055623</p> <p>1606.75603 504045133</p> <p style="text-align: right;">DX RH SX LH</p>
 	<p>Eurocargo 2009 75e13/120e18/Eurocargo 2009 120e21/180e28/Nuovo Stralis 2007 AD - AT/Nuovo Stralis 2007 AS</p> <p>FANALINO ANTERIORE FRONT CORNER LAMP</p> <p>COS.PEL. ref. 1606.90604 SIMILAR ref. 42555041 / 5801755123</p> <p>1606.90605 42555042 / 5801755132</p> <p style="text-align: right;">DX RH SX LH</p> <p style="font-size: small;">Relativo portalampada 1606.92810 Relativo portalampada 1606.92810</p>
	<p>Eurocargo 2009 75e13/120e18/Eurocargo 2009 120e21/180e28/Nuovo Stralis 2007 AD - AT/Nuovo Stralis 2007 AS</p> <p>PORTALAMPADA LAMP BULB HOLDER</p> <p>COS.PEL. ref. 1606.92810 SIMILAR ref. -</p> <p style="font-size: small;">Per / For : 1606.92802/3 - 1606.90604/5 - 1604.10604/5</p>
 	<p>Eurocargo 75-2015/Eurocargo 130-2015</p> <p>FANALINO CORNER LAMP</p> <p>COS.PEL. ref. 1606.71700 SIMILAR ref. 5801738337</p> <p style="text-align: right;">DX-SX RH-LH</p>



 <p>EUROCARGO 2003</p>	<p>Eurocargo 75-2015/Eurocargo 130-2015</p> <p>FANALINO LATERALE CORNER LAMP</p> <p>COS.PEL. ref. 1606.75924 SIMILAR ref. 504133023 / 5801573143 DX RH</p> <p>1606.75925 504107550 / 5801573145 SX LH</p>
	<p>Eurocargo 75-2015/Eurocargo 130-2015/Stralis Trakker HI-WAY/Stralis 2013 HI-WAY - AD/AT/Stralis 2013 HI-WAY - AS</p> <p>FANALINO LATERALE 4 LED SIDE LAMP 4 LED</p> <p>COS.PEL. ref. 002986 SIMILAR ref. 5801631615 DX-SX RH-LH</p>
	<p>Turbostar 190</p> <p>FANALINO LATERALE CORNER LAMP</p> <p>COS.PEL. ref. 1606.19480 SIMILAR ref. 42342171 DX-SX RH-LH</p>
 	<p>Eurotech</p> <p>FANALINO CORNER LAMP</p> <p>COS.PEL. ref. 1606.36360 SIMILAR ref. 98460036 DX RH</p> <p>1606.36361 98460038 SX LH</p>
 	<p>Eurotech/Eurostar</p> <p>FANALINO PEDANA LATERALE SIDE LAMP FOOTSTEP</p> <p>COS.PEL. ref. 1606.36362 SIMILAR ref. 98419235 DX RH</p> <p>1606.36363 98419234 SX LH</p>
 	<p>Eurotech/Eurostar</p> <p>FANALINO PEDANA LATERALE SIDE LAMP FOOTSTEP</p> <p>COS.PEL. ref. 1606.36364 SIMILAR ref. 500368110 DX RH</p> <p>1606.36365 500368111 SX LH</p>
 	<p>Eurostar</p> <p>FANALINO CORNER LAMP</p> <p>COS.PEL. ref. 1606.48480 SIMILAR ref. 98449181 DX RH</p> <p>1606.48481 98449182 SX LH</p>
	<p>Eurotrakker/Stralis Trakker/Stralis AD/AT/Stralis AS/Nuovo Stralis 2007 AD - AT/Nuovo Stralis 2007 AS/Stralis Trakker</p> <p>PORTALAMPADA LAMP BULB HOLDER</p> <p>COS.PEL. ref. 002987 SIMILAR ref. -</p> <p>Per lampada / For lamp : 002988</p>

 	<p>Eurotrakker/Stralis Trakker/Stralis AD/AT/Stralis AS/Nuovo Stralis 2007 AD - AT/Nuovo Stralis 2007 AS/Stralis Trakker</p> <p>FANALINO LATERALE W5W SIDE LAMP W5W COS.PEL. ref. 002988 SIMILAR ref. 41200664 Relativo portalampada 002987</p> <p style="text-align: right;">DX-SX RH-LH</p>
 	<p>Stralis AD/AT/Stralis AS</p> <p>FANALE LATERALE LAMPADINA ATTACCO AMP - JPT - Relativo connettore 003122 SIDE LAMP BULB CONNECTION AMP - JPT - Related connector 003122 COS.PEL. ref. 003001 SIMILAR ref. 500308514 ARANCIO / ORANGE - Relativo portalampada 1601.50013</p> <p style="text-align: right;">DX-SX RH-LH</p>
	<p>Stralis AD/AT/Stralis AS</p> <p>PORTALAMPADA Relativo connettore 003122 (JPT) LAMP BULB HOLDER Related connector 003122 (JPT) COS.PEL. ref. 1601.50013 SIMILAR ref. - Per lampada / For lamp : 003001 / 003003 / 003004</p>
 	<p>Stralis AD/AT/Stralis AS</p> <p>FANALINO LATERALE 2 FORI - GRIGIO CORNER LAMP 2 HOLES - GREY COS.PEL. ref. 1606.80044 SIMILAR ref. 504098243 grigio / 504250999 nero DX RH 1606.80045 504098245 grigio / 504250991 nero SX LH</p>
 	<p>Stralis AD/AT/Stralis AS/Nuovo Stralis 2007 AD - AT/Nuovo Stralis 2007 AS</p> <p>FANALINO LATERALE 3 FORI - GRIGIO SIDE LAMP 3 HOLES - GREY COS.PEL. ref. 1606.90602 SIMILAR ref. 41221039 GRIGIO / 504250984 NERO DX RH 1606.90603 41221029 GRIGIO / 504250958 NERO SX LH Relativo portalampada 1606.92811 - 003123</p>
	<p>Stralis AD/AT/Stralis AS/Nuovo Stralis 2007 AD - AT/Nuovo Stralis 2007 AS/Stralis 2013 HI-WAY - AS</p> <p>PORTALAMPADA LAMP BULB HOLDER COS.PEL. ref. 1606.92811 SIMILAR ref. - Per lampada / For lamp : 1606.90602/3</p>
 	<p>Stralis AD/AT/Stralis AS/Stralis Trakker HI-WAY</p> <p>FANALINO CORNER LAMP COS.PEL. ref. 1606.80040 SIMILAR ref. 41221040 / 42555022 DX RH 1606.80041 41221041 / 42555023 SX LH</p>
 	<p>Stralis Trakker HI-WAY</p> <p>FANALINO LATERALE 2 FORI - GRIGIO CORNER LAMP 2 HOLES - GREY COS.PEL. ref. 1606.92814 SIMILAR ref. 5801629858 / 5801754888 DX RH 1606.92813 Relativo portalampada : 5801629859 / 5801754889 SX LH Relativo portalampada :</p>

 	<p>Stralis 2013 HI-WAY - AD/AT/Stralis 2013 HI-WAY - AS</p> <p>FANALINO ANTERIORE DX FRONT LAMP</p> <p>COS.PEL. ref. 1606.92802 SIMILAR ref. 5801572018 / 5801755107 DX RH</p> <p>1606.92803 Relativo portalampada 1606.92810 5801572024 / 5801755108 SX LH</p> <p>Relativo portalampada 1606.92810</p>
	<p>Stralis 2013 HI-WAY - AD/AT/Stralis 2013 HI-WAY - AS</p> <p>FANALINO VISIERA SUN VISOR'S MARKER</p> <p>COS.PEL. ref. 1606.92804 SIMILAR ref. 5801546522 DX RH</p> <p>1606.92805 5801546548 SX LH</p>
 	<p>Stralis 2013 HI-WAY - AD/AT/Stralis 2013 HI-WAY - AS</p> <p>FANALINO LATERALE 3 FORI SIDE LAMP 3 HOLES</p> <p>COS.PEL. ref. 1606.92806 SIMILAR ref. 5801572074 / 5801754885 DX RH</p> <p>1606.92807 5801572080 / 5801754886 SX LH</p>

 	<p>TGA LX/TGA XL/XXL/TGA/TGS 6X4</p> <p>FANALINO LATERALE P21W SIDE LAMP P21W COS.PEL. ref. 1607.00708 SIMILAR ref. 81253206115 / 81253206117 DX-SX RH-LH</p>
 	<p>TGA LX/TGA XL/XXL/TGA/TGS 6X4</p> <p>FANALINO LATERALE P21W SIDE LAMP P21W COS.PEL. ref. 1607.00709 SIMILAR ref. 81253206116 / 81253206118 DX-SX RH-LH</p>
	<p>TGA LX/TGA XL/XXL/TGA/TGS 6X4</p> <p>FANALINO LATERALE LED 4 LED SIDE LAMP LED 4 LED COS.PEL. ref. 1607.00710 SIMILAR ref. 81252606101 DX-SX RH-LH</p>
 	<p>TGA LX/TGA XL/XXL/TGA/TGS 6X4</p> <p>FANALINO LATERALE P21W SIDE LAMP P21W COS.PEL. ref. 1607.00711 SIMILAR ref. 81253206102 DX-SX RH-LH</p>
 	<p>TGA LX/TGA XL/XXL/TGA/TGS 6X4</p> <p>FANALINO LATERALE P21W SIDE LAMP P21W COS.PEL. ref. 1607.00712 SIMILAR ref. 81253206100 DX-SX RH-LH</p>
	<p>TGA LX/TGA XL/XXL/TGA/TGS 6X4/TGS</p> <p>FANALINO INGOMBRO CABINA TETTO BASSO DRIVER CAB SIDE MARKER LOW CAB COS.PEL. ref. 1607.00713 SIMILAR ref. 81252606099 DX-SX RH-LH</p>
	<p>TGA LX/TGA XL/XXL/TGA/TGS 6X4/TGX</p> <p>FANALINO INGOMBRO CABINA LED TETTO ALTO DRIVER CAB SIDE MARKER HIGH CAB COS.PEL. ref. 1607.00714 SIMILAR ref. 81252606121 DX-SX RH-LH</p>
	<p>TGA XL/XXL</p> <p>FANALINO INGOMBRO CABINA TETTO BASSO DRIVER CAB SIDE MARKER LED RH-LH LOW CAB COS.PEL. ref. 1607.00717 SIMILAR ref. - DX-SX RH-LH</p>

	<p>Universali / Universal</p> <p>FANALE INGOMBRO BRACCIO CURVO GOMMA ROSSO/INCOLORE DRIVER CAB. MARKER RUBBER ARM RED/CLEAR LENS COS.PEL. ref. 002000</p> <p style="text-align: right;">DX-SX RH-LH</p>
	<p>Universali / Universal</p> <p>FANALE INGOMBRO BRACCIO DRITTO GOMMA ROSSO/INCOLORE DRIVER CAB. MARKER RUBBER ARM RED/CLEAR LENS COS.PEL. ref. 002001</p> <p style="text-align: right;">DX-SX RH-LH</p>
	<p>Universali / Universal</p> <p>FANALE INGOMBRO LATERALE LED LED - 12 / 24 Volt SIDE MARKER LED LED - 12 / 24 Volt COS.PEL. ref. 002003 12 / 24 Volt</p> <p style="text-align: right;">DX-SX RH-LH</p>
	<p>Universali / Universal</p> <p>FANALE INGOMBRO LATERALE LED LED - 12 / 24 Volt SIDE MARKER LED LED - 12 / 24 Volt COS.PEL. ref. 002004 12 / 24 Volt</p> <p style="text-align: right;">DX-SX RH-LH</p>
	<p>Universali / Universal</p> <p>FANALE INGOMBRO LATERALE LED LED - 12 / 24 Volt SIDE MARKER LED LED - 12 / 24 Volt COS.PEL. ref. 002005 12 / 24 Volt</p> <p style="text-align: right;">DX-SX RH-LH</p>
	<p>Universali / Universal</p> <p>FANALE INGOMBRO LATERALE LED LED - 12 / 24 Volt LED SIDE MARKER LED - 12 / 24 Volt COS.PEL. ref. 002006 12 / 24 Volt</p> <p style="text-align: right;">DX-SX RH-LH</p>
	<p>Universali / Universal</p> <p>FANALE INGOMBRO LATERALE LED LED - 12 / 24 Volt LED SIDE MARKER LED - 12 / 24 Volt COS.PEL. ref. 002007 12 / 24 Volt</p> <p style="text-align: right;">DX-SX RH-LH</p>
	<p>Universali / Universal</p> <p>FANALE INGOMBRO BRACCIO CURVO LED LED - ROSSO/INCOLORE - 12 / 24 Volt DRIVER CAB. MARKER ARM LED LED - RED/CLEAR LENS - 12 / 24 Volt COS.PEL. ref. 002008 12 / 24 Volt DX RH</p> <p>002013 12 / 24 Volt SX LH</p>

Segnalatori Beacons

Universali / Universal



	<p>Universali / Universal</p> <p>FANALE INGOMBRO LED ROSSO/INCOLORE - 8 LED - STAFFA A 45 GRADI - 12 / 24 Volt DRIVER CAB. MARKER LED RED/CLEAR LENS - 8 LED - BRACKET 45 DEGREES - 12 / 24 Volt COS.PEL. ref. 002012 12 / 24 Volt DX-SX RH-LH</p>
	<p>Universali / Universal</p> <p>FANALE INGOMBRO LED ROSSO/INCOLORE - 8 LED - 12 / 24 Volt DRIVER CAB. MARKER LED RED/CLEAR LENS - 8 LED - 12 / 24 Volt COS.PEL. ref. 002014 12 / 24 Volt DX-SX RH-LH</p>
	<p>Universali / Universal</p> <p>FANALE INGOMBRO 1 LED 1 LED - 12 / 24 Volt DRIVER CAB. MARKER LED 1 LED - 12 / 24 Volt COS.PEL. ref. 002015 12 / 24 Volt DX-SX RH-LH</p>
	<p>Universali / Universal</p> <p>FANALE INGOMBRO LED ROSSO/INCOLORE - 8 LED - STAFFA A 90 GRADI DRIVER CAB. MARKER LED RED/CLEAR LENS - 8 LED - BRACKET 90 DEGREES COS.PEL. ref. 002016 12 / 24 Volt DX RH</p> <p>002019 12 / 24 Volt SX LH</p>
	<p>Universali / Universal</p> <p>FANALE INGOMBRO 8 LED 8 LED - 12 / 24 Volt DRIVER CAB. MARKER LED 8 LED - 12 / 24 Volt COS.PEL. ref. 002017 12 / 24 Volt DX-SX RH-LH</p>
	<p>Universali / Universal</p> <p>FANALE INGOMBRO LED ROSSO/INCOLORE - 8 LED - 12 / 24 Volt DRIVER CAB. MARKER LED RED/CLEAR LENS - 8 LED - 12 / 24 Volt COS.PEL. ref. 002018 12 / 24 Volt DX-SX RH-LH</p>
	<p>Universali / Universal</p> <p>FANALE INGOMBRO LED ROSSO/INCOLORE - 8 LED - BRACKET 90 DEGREES - 12 / 24 Volt DRIVER CAB. MARKER LED RED/CLEAR LENS - 8 LED - STAFFA A 90 GRADI - 12 / 24 Volt COS.PEL. ref. 002020 12 / 24 Volt DX-SX RH-LH</p>
	<p>Universali / Universal</p> <p>FANALE INGOMBRO 12 / 24 Volt RUBBER LIGHT 12 / 24 Volt COS.PEL. ref. 002021 12 / 24 Volt DX-SX RH-LH</p>



	<p>Universali / Universal</p> <p>FANALE INGOMBRO 12 / 24 Volt RUBBER LIGHT 12 / 24 Volt COS.PEL. ref. 002022 12 / 24 Volt DX-SX RH-LH</p>
	<p>Universali / Universal</p> <p>FANALE INGOMBRO 12 / 24 Volt RUBBER LIGHT 12 / 24 Volt COS.PEL. ref. 002023 12 / 24 Volt DX-SX RH-LH</p>
	<p>Universali / Universal</p> <p>FANALE INGOMBRO 2 LED 24 Volt RUBBER LIGHT 2 LED 24 Volt COS.PEL. ref. 002024 2 LED 24 Volt DX RH</p> <p>002025 2 LED 24 Volt SX LH</p>
	<p>Universali / Universal</p> <p>FANALE INGOMBRO 24V 3W RUBBER LIGHT 24V 3W COS.PEL. ref. 002026 24 Volt - Lampadina G11 24V3W DX RH</p> <p>002027 24 Volt - Lampadina G11 24V3W SX LH</p>
	<p>Universali / Universal</p> <p>FANALE INGOMBRO BRACCIO DIRITTO LED LED - ROSSO/INCOLORE - 12 / 24 Volt DRIVER CAB. MARKER RUBBER ARM LED LED - RED/CLEAR LENS - 12 / 24 Volt COS.PEL. ref. 002028 12 / 24 Volt DX RH</p> <p>002009 12 / 24 Volt SX LH</p>
	<p>Universali / Universal</p> <p>FANALE INGOMBRO BRACCIO CURVO GOMMA LED LED - ROSSO/INCOLORE - 12 / 24 Volt DRIVER CAB. MARKER RUBBER ARM LED LED - RED/CLEAR LENS - 12 / 24 Volt COS.PEL. ref. 002100 12 / 24 Volt DX RH</p> <p>002099 12 / 24 Volt SX LH</p>
	<p>Universali / Universal</p> <p>FANALE INGOMBRO BRACCIO DIRITTO GOMMA LED LED - 12 / 24 Volt DRIVER CAB. MARKER RUBBER ARM LED LED - 12 / 24 Volt COS.PEL. ref. 002102 12 / 24 Volt DX RH</p> <p>002101 12 / 24 Volt SX LH</p>



  	<p>Led / Led</p> <p>FANALINO LATERALE 4 LED SIDE LAMP 4 LED COS.PEL. ref. 002986</p> <p style="text-align: right;">DX-SX RH-LH</p>
	<p>Led / Led</p> <p>FANALE LATERALE 1 LED LED SIDE LAMP 1 LED LED COS.PEL. ref. 002989</p> <p style="text-align: right;">DX-SX RH-LH</p> <p>002990 BIANCO / WHITE DX-SX RH-LH</p> <p style="text-align: right;">ARANCIO / ORANGE DX-SX RH-LH</p>
<p>AD ESAURIMENTO SCORTE UNTIL SELL-OUT</p> 	<p>Led / Led</p> <p>FANALINO PSI AMP 2 LED 2 LED ATTACCO AMP 12/24V MARKER PSI AMP 2 LED 2 LED PLUG AMP 12/24V COS.PEL. ref. 002991 ARANCIO / ORANGE (12/24 V) DX-SX RH-LH 002993 BIANCO / WHITE (12/24 V) DX-SX RH-LH 002995 ROSSO / RED (12/24 V) DX-SX RH-LH</p>
<p>AD ESAURIMENTO SCORTE UNTIL SELL-OUT</p> 	<p>Led / Led</p> <p>FANALINO PSI CON CAVO 2 LED 2 LED CON CAVO 0,5mt 12/24V MARKER PSI FLAT CABLE 2 LED 2 LED FLAT CABLE 0,5mt 12/24V COS.PEL. ref. 002992 ARANCIO / ORANGE (12/24 V) DX-SX RH-LH 002994 BIANCO / WHITE (12/24 V) DX-SX RH-LH 002996 ROSSO / RED (12/24 V) DX-SX RH-LH</p>
	<p>Led / Led</p> <p>FANALE LATERALE 3 LED DX-SX 3 LED - 12 / 24 Volt SIDE MARKER 3 LED 3 LED - 12 / 24 Volt COS.PEL. ref. 002999 ARANCIO / ORANGE (12/24 V) DX-SX RH-LH</p>
	<p>Led / Led</p> <p>FANALE LATERALE LED 4 LED - 12 / 24 Volt SIDE LAMP LED 4 LED - 12 / 24 Volt COS.PEL. ref. 003000 ARANCIO / ORANGE (12/24 V) DX-SX RH-LH</p>
	<p>Led / Led</p> <p>FANALE LATERALE LED 4 LED - ATTACCO AMP-JPT - 12 / 24 Volt SIDE LAMP LED 4 LED - CONNECTION AMP-JPT - 12 / 24 Volt COS.PEL. ref. 003002 ARANCIO / ORANGE (12/24 V) DX-SX RH-LH</p>
	<p>Led / Led</p> <p>FANALE LATERALE LED 4 LED - 12 / 24 Volt - Relativo connettore 003122 SIDE LAMP LED 4 LED - 12 / 24 Volt - Relativo connettore 003122 COS.PEL. ref. 003004 BIANCO / WHITE (12/24 V) - Relativo portalampada 1601.50013 DX-SX RH-LH</p>

	<p>Led / Led</p> <p>FANALE LATERALE LED 4 LED - 12 / 24 Volt SIDE LAMP LED 4 LED - 12 / 24 Volt COS.PEL. ref. 003006 ARANCIO / ORANGE (12/24 V) DX-SX RH-LH</p>
	<p>Led / Led</p> <p>FANALE LATERALE LED 6 LED - 12 / 24 Volt SIDE LAMP LED 6 LED - 12 / 24 Volt COS.PEL. ref. 003007 ARANCIO / ORANGE (12/24 V) DX-SX RH-LH</p>
	<p>Led / Led</p> <p>FANALINO LATERALE LED 3 LED - CON CAVO 15 CM SIDE MARKER LED 3 LED - WITH 15 CM CABLE COS.PEL. ref. 003008 ARANCIO / ORANGE (12/24 V) DX-SX RH-LH 003009 BIANCO / WHITE (12/24 V) DX-SX RH-LH 003010 ROSSO / RED (12/24 V) DX-SX RH-LH</p>
	<p>Led / Led</p> <p>FANALINO LATERALE LED 2 LED SIDE MARKER LED 2 LED COS.PEL. ref. 003013 ARANCIO / ORANGE (12/24 V) DX-SX RH-LH</p>
	<p>Led / Led</p> <p>FANALINO LATERALE LED 4 LED SIDE MARKER LED 4 LED COS.PEL. ref. 003014 ARANCIO / ORANGE (12/24 V) DX-SX RH-LH</p>
	<p>Led / Led</p> <p>FANALINO LATERALE LED 4 LED SIDE MARKER LED 4 LED COS.PEL. ref. 003015 ARANCIO / ORANGE (12/24 V) DX-SX RH-LH</p>
	<p>Led / Led</p> <p>FANALINO LATERALE LED 2 LED SIDE MARKER LED 2 LED COS.PEL. ref. 003016 BIANCO / WHITE (12/24 V) DX-SX RH-LH 003017 ARANCIO / ORANGE (12/24 V) DX-SX RH-LH 003018 ROSSO / RED (12/24 V) DX-SX RH-LH</p>
<p>AD ESAURIMENTO SCORTE UNTIL SELL-OUT</p> 	<p>Led / Led</p> <p>STRISCIA LED 11 LED STRING LED 11 LED COS.PEL. ref. 003022 ROSSA / RED (12/24 V)</p>

<p>AD ESAURIMENTO SCORTE UNTIL SELL OUT</p>	<p>Led / Led</p> <p>FANALINO LATERALE LED 4 LED - CON CAVO 15 CM SIDE MARKER LED 4 LED - WITH 15 CM CABLE COS.PEL. ref.</p> <table border="0"> <tr> <td>003023</td> <td>ARANCIO / ORANGE (12/24 V)</td> <td>DX-SX RH-LH</td> </tr> <tr> <td>003024</td> <td>BIANCO / WHITE (12/24 V)</td> <td>DX-SX RH-LH</td> </tr> <tr> <td>003025</td> <td>ROSSO / RED (12/24 V)</td> <td>DX-SX RH-LH</td> </tr> </table>	003023	ARANCIO / ORANGE (12/24 V)	DX-SX RH-LH	003024	BIANCO / WHITE (12/24 V)	DX-SX RH-LH	003025	ROSSO / RED (12/24 V)	DX-SX RH-LH						
003023	ARANCIO / ORANGE (12/24 V)	DX-SX RH-LH														
003024	BIANCO / WHITE (12/24 V)	DX-SX RH-LH														
003025	ROSSO / RED (12/24 V)	DX-SX RH-LH														
	<p>Led / Led</p> <p>FANALE LATERALE LED 2 LED SIDE LAMP LED 2 LED COS.PEL. ref.</p> <table border="0"> <tr> <td>003005</td> <td>ARANCIO / ORANGE (12/24 V)</td> <td>DX-SX RH-LH</td> </tr> <tr> <td>003026</td> <td>ROSSO / RED (12/24 V)</td> <td>DX-SX RH-LH</td> </tr> <tr> <td>003027</td> <td>BIANCO / WHITE (12/24 V)</td> <td>DX-SX RH-LH</td> </tr> </table>	003005	ARANCIO / ORANGE (12/24 V)	DX-SX RH-LH	003026	ROSSO / RED (12/24 V)	DX-SX RH-LH	003027	BIANCO / WHITE (12/24 V)	DX-SX RH-LH						
003005	ARANCIO / ORANGE (12/24 V)	DX-SX RH-LH														
003026	ROSSO / RED (12/24 V)	DX-SX RH-LH														
003027	BIANCO / WHITE (12/24 V)	DX-SX RH-LH														
	<p>Led / Led</p> <p>STRISCIA LED ROSSA 10 LED STRING LED RED 10 LED COS.PEL. ref.</p> <table border="0"> <tr> <td>003028</td> <td>ROSSA / RED (24V)</td> <td></td> </tr> <tr> <td>003029</td> <td>BIANCA / WHITE (24 V)</td> <td></td> </tr> </table>	003028	ROSSA / RED (24V)		003029	BIANCA / WHITE (24 V)										
003028	ROSSA / RED (24V)															
003029	BIANCA / WHITE (24 V)															
	<p>Led / Led</p> <p>SUPPORTO DI PLASTICA PLASTIC BRACKET COS.PEL. ref.</p> <p>003030</p>															
	<p>Led / Led</p> <p>FANALE LATERALE 6 LED 6 LED - CON CAVO SIDE MARKER LAMP 6 LED 6 LED - WITH CABLE COS.PEL. ref.</p> <table border="0"> <tr> <td>003033</td> <td>ARANCIO / ORANGE (12/24 V)</td> <td>DX-SX RH-LH</td> </tr> <tr> <td>003034</td> <td>ROSSO / RED (12/24 V)</td> <td>DX-SX RH-LH</td> </tr> <tr> <td>003035</td> <td>BIANCO / WHITE (24 V)</td> <td>DX-SX RH-LH</td> </tr> <tr> <td>003038</td> <td>VERDE / GREEN (24 V)</td> <td>DX-SX RH-LH</td> </tr> <tr> <td>003039</td> <td>BLU / BLUE (24 V)</td> <td>DX-SX RH-LH</td> </tr> </table>	003033	ARANCIO / ORANGE (12/24 V)	DX-SX RH-LH	003034	ROSSO / RED (12/24 V)	DX-SX RH-LH	003035	BIANCO / WHITE (24 V)	DX-SX RH-LH	003038	VERDE / GREEN (24 V)	DX-SX RH-LH	003039	BLU / BLUE (24 V)	DX-SX RH-LH
003033	ARANCIO / ORANGE (12/24 V)	DX-SX RH-LH														
003034	ROSSO / RED (12/24 V)	DX-SX RH-LH														
003035	BIANCO / WHITE (24 V)	DX-SX RH-LH														
003038	VERDE / GREEN (24 V)	DX-SX RH-LH														
003039	BLU / BLUE (24 V)	DX-SX RH-LH														
	<p>Led / Led</p> <p>FANALE LATERALE 2 LED 2 LED SIDE LAMP 2 LED 2 LED COS.PEL. ref.</p> <table border="0"> <tr> <td>003036</td> <td>BIANCO / WHITE (12/24 V)</td> <td>DX-SX RH-LH</td> </tr> <tr> <td>003037</td> <td>ARANCIO / ORANGE (12/24 V)</td> <td>DX-SX RH-LH</td> </tr> </table>	003036	BIANCO / WHITE (12/24 V)	DX-SX RH-LH	003037	ARANCIO / ORANGE (12/24 V)	DX-SX RH-LH									
003036	BIANCO / WHITE (12/24 V)	DX-SX RH-LH														
003037	ARANCIO / ORANGE (12/24 V)	DX-SX RH-LH														

<p>AD ESAURIMENTO SCORTE UNTIL SELL-OUT</p> 	<p>Lampadine / Bulbs</p> <p>FANALE LATERALE LAMPADINA SIDE LAMP BULB BULB COS.PEL. ref. 002998</p> <p>ARANCIO / ORANGE</p> <p>DX-SX RH-LH</p>
 	<p>Lampadine / Bulbs</p> <p>FANALE LATERALE LAMPADINA ATTACCO AMP - JPT - Relativo connettore 003122 SIDE LAMP BULB CONNECTION AMP - JPT - Related connector 003122 COS.PEL. ref. 003001</p> <p>ARANCIO / ORANGE - Relativo port- talampada 1601.50013</p> <p>DX-SX RH-LH</p>
	<p>Lampadine / Bulbs</p> <p>FANALE LATERALE LAMPADINA ATTACCO AMP-JPT - W5W - Relativo connettore 003122 SIDE LAMP BULB CONNECTION AMP-JPT - W5W - Relativo connettore 003122 COS.PEL. ref. 003003</p> <p>BIANCO / WHITE - Relativo port- lampada 1601.50013</p> <p>DX-SX RH-LH</p>

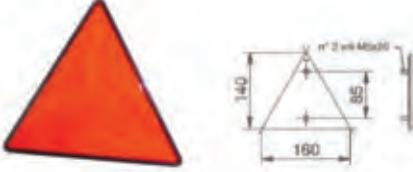
	<p>Catadiottri / Reflectors</p> <p>CATADIOTTRO DIAMETRO 60 mm CON VITE M5X20 REFLECTOR DIAMETER 60 mm WITH SCREW M5X20 COS.PEL. ref.</p> <p>004000 BIANCO / WHITE 004001 ARANCIO / ORANGE 004002 ROSSO / RED</p>
	<p>Catadiottri / Reflectors</p> <p>CATADIOTTRO DIAMETRO 60 mm CON FORO 5,3 mm REFLECTOR DIAMETER 60 mm WITH HOLE 5,3 mm COS.PEL. ref.</p> <p>004003 BIANCO / WHITE 004004 ARANCIO / ORANGE 004005 ROSSO / RED</p>
	<p>Catadiottri / Reflectors</p> <p>CATADIOTTRO DIAMETRO 60 mm CON BASE ADESIVA REFLECTOR DIAMETER 60 mm WITH ADHESIVE BASE COS.PEL. ref.</p> <p>004006 BIANCO / WHITE 004007 ARANCIO / ORANGE 004008 ROSSO / RED</p>
	<p>Catadiottri / Reflectors</p> <p>CATADIOTTRO DIAMETRO 80 mm CON VITE M5X20 REFLECTOR DIAMETER 80 mm WITH SCREW M5X20 COS.PEL. ref.</p> <p>004009 BIANCO / WHITE 004010 ARANCIO / ORANGE 004011 ROSSO / RED</p>
<p>AD ESAURIMENTO SCORTE UNTIL SELL-OUT</p>	<p>Catadiottri / Reflectors</p> <p>CATADIOTTRO DIAMETRO 80 mm CON FORO 5,3 mm REFLECTOR DIAMETER 80 mm WITH HOLE 5,3 mm COS.PEL. ref.</p> <p>004012 BIANCO / WHITE 004013 ARANCIO / ORANGE 004014 ROSSO / RED</p>
<p>AD ESAURIMENTO SCORTE UNTIL SELL-OUT</p>	<p>Catadiottri / Reflectors</p> <p>CATADIOTTRO DIAMETRO 80 mm CON BASE ADESIVA REFLECTOR DIAMETER 80 mm WITH ADHESIVE BASE COS.PEL. ref.</p> <p>004015 BIANCO / WHITE 004016 ARANCIO / ORANGE 004017 ROSSO / RED</p>
<p>AD ESAURIMENTO SCORTE UNTIL SELL-OUT</p>	<p>Catadiottri / Reflectors</p> <p>CATADIOTTRO RETT. 60x42mm CON BASE ADESIVA REFLECTOR RECT. 60x42mm WITH ADHESIVE BASE COS.PEL. ref.</p> <p>004018 BIANCO / WHITE 004019 ARANCIO / ORANGE 004020 ROSSO / RED</p>
<p>AD ESAURIMENTO SCORTE UNTIL SELL-OUT</p>	<p>Catadiottri / Reflectors</p> <p>CATADIOTTRO RETT. 100x46mm CON BASE ADESIVA REFLECTOR RECT. 100x46mm WITH ADHESIVE BASE COS.PEL. ref.</p> <p>004021 BIANCO / WHITE 004022 ARANCIO / ORANGE 004023 ROSSO / RED</p>

<p>AD ESAURIMENTO SCORTE UNTIL SELL-OUT</p> 	<p>Catadiottri / Reflectors</p> <p>CATADIOTTRO RETT.100x46mm CON BASE FORATA REFLECTOR RECT.100x46mm WITH PERFORATED BASE COS.PEL. ref. 004024 BIANCO / WHITE 004025 ARANCIO / ORANGE 004026 ROSSO / RED</p>
	<p>Catadiottri / Reflectors</p> <p>CATADIOTTRO TRIANGOLARE CON VITE REFLECTOR TRIANGULAR WITH SCREW COS.PEL. ref. 004027 -</p>
	<p>Catadiottri / Reflectors</p> <p>CATADIOTTRO TRANGOLARE CON 2 FORI INTERASSE 70 mm REFLECTOR TRIANGULAR WITH 2 HOLES WHEELBASE 70 mm COS.PEL. ref. 004028 -</p>
<p>AD ESAURIMENTO SCORTE UNTIL SELL-OUT</p> 	<p>Catadiottri / Reflectors</p> <p>CATADIOTTRO TRIANGOLARE CON 2 FORI INTERASSE 85 mm REFLECTOR TRIANGULAR WITH 2 HOLES WHEELBASE 85 mm COS.PEL. ref. 004029 -</p>

Segnalatori Beacons

Fari Rotanti / Rotating lamps



**AD ESAURIMENTO
SCORTE**
UNTIL
SELL-OUT



Fari Rotanti / Rotating lamps

FARO LAVORO
Adattabile a lampadine HID02
WORK LAMP
Only suitable for HID02 Bulb
COS.PEL. ref.
003020

**AD ESAURIMENTO
SCORTE**
UNTIL
SELL-OUT



Fari Rotanti / Rotating lamps

SEGNALATORE ROTANTE LED
24 LEDS * 0.5W
ROTATING BEACON LED
24 LEDS * 0.5W
COS.PEL. ref.
003032



Fari Rotanti / Rotating lamps

FARO ROTANTE
H1 12/24V
ROTATING BEACON
H1 12/24V
COS.PEL. ref.
003040 Lente/Glass : **003045**



Fari Rotanti / Rotating lamps

FARO ROTANTE H1 12/24V
H1 12/24V
ROTATING BEACON
H1 12/24V
COS.PEL. ref.
003041 Lente/Glass : **003045**



Fari Rotanti / Rotating lamps

FARO ROTANTE H1 12/24V
H1 12/24V - Fissaggio combinato ventosa/magnete
ROTATING BEACON
H1 12/24V - Combined magnetic-suction cup fastening
COS.PEL. ref.
003043 Lente/Glass : **003045**



Fari Rotanti / Rotating lamps

CALOTTA LISCIA ARANCIO "DYNAMIC"
POLICARBONATO - PER FARI ROTANTI
ORANGE SMOOTH LENS "DYNAMIC"
POLYCARBON - FOR ROTATING BEACONS
COS.PEL. ref.
003045



Fari Rotanti / Rotating lamps







FARO ROTANTE
H1 - BIVOLTAGGIO 12-24V - FISSAGGIO 3 VITI
ROTATING BEACON
H1 - BIVOLTAGE 12-24V - 3 SCREWS MOUNTING
COS.PEL. ref.
003050 Lente/Glass : **003053**



Fari Rotanti / Rotating lamps

FARO ROTANTE
H1 - BIVOLTAGGIO 12-24V - FISSAGGIO MAGNETICO - CAVO LUNGO METRI 4 E SPINOTTO ACCEN-
ROTATING BEACON
H1 - BIVOLTAGE 12-24V - MAGNETIC MOUNTING - 4 METERS LONG COILED CABLE - LIGHTER PLUG
COS.PEL. ref.
003051 Lente/Glass : **003053**

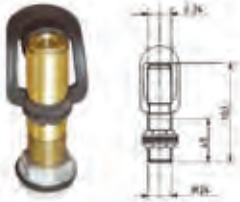
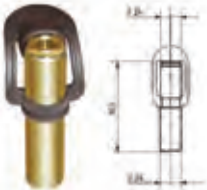

	<p>Fari Rotanti / Rotating lamps</p> <p>FARO ROTANTE H1 - BIVOLTAGGIO 12-24V - BASE PER FISSAGGIO INNESTO TUBOLARE ROTATING BEACON H1 - BIVOLTAGE 12-24V - BASE FOR FITTING ON PIN COS.PEL. ref. 003052 Lente/Glass : 003053</p>
	<p>Fari Rotanti / Rotating lamps</p> <p>CALOTTA ARANCIO PER FARO ROTANTE ORANGE SMOOTH LENS COS.PEL. ref. 003053</p>
	<p>Fari Rotanti / Rotating lamps</p> <p>CAVO SPIRALATO (2 x 0,75 mm) Lunghezza esteso: 4 m. SPIRAL CORD (2 x 0,75 mm) Stretched length: 4 m. COS.PEL. ref. 003054</p>
	<p>Fari Rotanti / Rotating lamps</p> <p>CAVO SPIRALATO (2 x 0,75 mm) Lunghezza esteso: 4 m. Completo di spinotto universale (codice 003059) SPIRAL CORD (2 x 0,75 mm) Stretched length: 4 m. With universal cigarette lighter plug (ref. 003059) COS.PEL. ref. 003055</p>
	<p>Fari Rotanti / Rotating lamps</p> <p>SUPPORTO ISO A FILETTATO COMPLETO COMPLETE ISO A THREADED SUPPORT COS.PEL. ref. 003056</p>
	<p>Fari Rotanti / Rotating lamps</p> <p>SUPPORTO ISO A LISCIIO COMPLETO COMPLETE ISO A SMOOTH SUPPORT COS.PEL. ref. 003057</p>
	<p>Fari Rotanti / Rotating lamps</p> <p>SUPPORTO ISO A LISCIIO CON STAFFA SMOOTH ISO A SUPPORT WITH SCREW BRACKET COS.PEL. ref. 003058</p>
	<p>Fari Rotanti / Rotating lamps</p> <p>SPINOTTO PRESA ACCENDISIGARI UNIVERSALE UNIVERSAL CIGARETTE LIGHTER-PLUG COS.PEL. ref. 003059</p>

Segnalatori Beacons

Fari Rotanti / Rotating lamps



AD ESAURIMENTO
SCORTE
UNTIL
SELL-OUT



Fari Rotanti / Rotating lamps

FARO ROTANTE LED 10/30V

LED 10/30V
ROTATING BEACON LED 10/30V
LED 10/30V
COS.PEL. ref.
003060

Lente/Glass : 003045

AD ESAURIMENTO
SCORTE
UNTIL
SELL-OUT



Fari Rotanti / Rotating lamps

FARO ROTANTE LED 10/30V

LED - 10/30V - MAGNETICO
ROTATING BEACON LED 10/30V
LED - 10/30V - MAGNETIC
COS.PEL. ref.
003061

Lente/Glass : 003045



Fari Rotanti / Rotating lamps

FARO LAVORO

6 LED - 10/30V - 12W - 1500 LUMEN - ATTACCO DT 2 VIE - CON CAVO
WORK LAMP
6 LED - 10/30V - 12W - 1500 LUMEN - DT 2 WAYS - WITH CABLE
COS.PEL. ref.
1300.00000

Fari Rotanti / Rotating lamps

FARO LAVORO

6 LED - 10/30V - 12W - 1500 LUMEN - ATTACCO DT 2 VIE - BASE MAGNETICA
WORK LAMP
6 LED - 10/30V - 12W - 1500 LUMEN - DT 2 WAYS - WITH MAGNETIC BASE
COS.PEL. ref.
1300.00001



Fari Rotanti / Rotating lamps

FARO LAVORO - "OMOLOGATO PER RETROMARCIA"

4 LED - 10/30V - 9W - 1000 LUMEN - CON CAVO
WORK LAMP - "APPROVED FOR REVERSING"
4 LED - 10/30V - 9W - 1000 LUMEN - WITH CABLE
COS.PEL. ref.
1300.00002



Fari Rotanti / Rotating lamps

PLAFONIERA LUCE INTERNA

4 LED - 10/30V - 500 LUMEN - SENZA RILEVATORE DI MOVIMENTO E CALORE (PIR)
CEILING LIGHT
4 LED - 10/30V - 500 LUMEN - WITHOUT MOTION AND HEAT DETECTOR (PIR)
COS.PEL. ref.
1300.00100

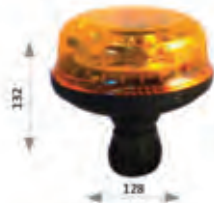

Fari Rotanti / Rotating lamps

FARO ROTANTE RIBASSATO LED - (3 ANNI DI GARANZIA)

10/30V - 9W - 3 funzioni omologate ECE R65
ROTATING BEACON LED - (3 YEARS WARRANTY)
10/30V - 9W
COS.PEL. ref.
2300.00000

Lente/Glass : 2300.10000



Fari Rotanti / Rotating lamps

FARO ROTANTE RIBASSATO LED - (3 ANNI DI GARANZIA)

10/30V - 9W - 3 funzioni omologate ECE R65
ROTATING BEACON LED - (3 YEARS WARRANTY)
10/30V - 9W
COS.PEL. ref.
2300.00001

Lente/Glass : 2300.10000



	<p>Fari Rotanti / Rotating lamps</p> <p>FARO ROTANTE RIBASSATO LED - (3 ANNI DI GARANZIA) 10/30V - 9W - 3 funzioni omologate ECE R65 ROTATING BEACON LED - (3 YEARS WARRANTY) 10/30V - 9W COS.PEL. ref. 2300.00002 Lente/Glass : 2300.10000</p>
	<p>Fari Rotanti / Rotating lamps</p> <p>FARO ROTANTE LED Su staffa - 10/30V - 9W ROTATING BEACON LED 10/30V - 9W COS.PEL. ref. 2300.00003 Lente/Glass : 2300.10001</p>
	<p>Fari Rotanti / Rotating lamps</p> <p>FARO ROTANTE LED Fissaggio a 3 punti - 10/30V - 9W ROTATING BEACON LED 10/30V - 9W COS.PEL. ref. 2300.00004 Lente/Glass : 2300.10001</p>
	<p>Fari Rotanti / Rotating lamps</p> <p>FARO ROTANTE LED Base magnetica - 10/30V - 9W ROTATING BEACON LED 10/30V - 9W COS.PEL. ref. 2300.00005 Lente/Glass : 2300.10001</p>
	<p>Fari Rotanti / Rotating lamps</p> <p>LENTE PER FARO ROTANTE RIBASSATO LED Per 2300.00000/1/2 ROTATING BEACON LED GLASS For 2300.00000/1/2 COS.PEL. ref. 2300.10000 Per 2300.00000/1/2</p>
	<p>Fari Rotanti / Rotating lamps</p> <p>LENTE PER FARO ROTANTE LED Per 2300.00003/4/5 ROTATING BEACON LED GLASS For 2300.00003/4/5 COS.PEL. ref. 2300.10001 Per 2300.00003/4/5</p>





Parti di ricambio adattabili a:
Spare parts suitable to:



H1 Halogen Bulb

12 VOLT - H1 - 55 WATT - P14.5S

COS.PEL. ref.	SIMILAR ref.	
012.H1101	HELLA	8GH 002 089 - 131
	OSRAM	64150
	PHILIPS	12258

Ordinabile solo per conf. di 10 pz. / Sold by package of 10 pcs.



H2 Halogen Bulb

12 VOLT - H2 - 55 WATT - X511

COS.PEL. ref.	SIMILAR ref.	
012.H2102	OSRAM	64173
	PHILIPS	12311

Ordinabile solo per conf. di 10 pz. / Sold by package of 10 pcs.



H3 Halogen Bulb

12 VOLT - H3 - 55 WATT - PK22S

COS.PEL. ref.	SIMILAR ref.	
012.H3103	HELLA	8GH 002 090 - 131
	OSRAM	64151
	PHILIPS	12336

Ordinabile solo per conf. di 10 pz. / Sold by package of 10 pcs.



H3 Halogen Bulb

12 VOLT - H3 - 100 WATT - PK22S

COS.PEL. ref.	SIMILAR ref.	
012.H3104	PHILIPS	12455

Ordinabile solo per conf. di 10 pz. / Sold by package of 10 pcs.



H4 Halogen Bulb

12 VOLT - H4 - 60/55 WATT - P43T

COS.PEL. ref.	SIMILAR ref.	
012.H4104	HELLA	8GJ 003 525 - 131
	OSRAM	94193
	PHILIPS	12342

Ordinabile solo per conf. di 10 pz. / Sold by package of 10 pcs.



H5 Halogen Bulb

12 VOLT - H5 - 60/55 WATT - P45T

COS.PEL. ref.	SIMILAR ref.	
012.H5101	HELLA	8GJ 004 173 - 121

Ordinabile solo per conf. di 10 pz. / Sold by package of 10 pcs.



H6 Halogen Bulb

12 VOLT - H6 - 6 WATT - BAX9S

COS.PEL. ref.	SIMILAR ref.	
012.H6101	PHILIPS	12036

Ordinabile solo per conf. di 10 pz. / Sold by package of 10 pcs.











H7 Halogen Bulb

12 VOLT - H7 - 55 WATT - PX26D

COS.PEL. ref.	SIMILAR ref.	
012.H7105	HELLA	8GH 007 157 - 121
	OSRAM	64210
	PHILIPS	12972

Ordinabile solo per conf. di 10 pz. / Sold by package of 10 pcs.

	<p>H8 Halogen Bulb</p> <p>12 VOLT - 35 WATT - PGJ19-1</p> <p>COS.PEL. ref. 012.H8106 SIMILAR ref. PHILIPS 12360</p> <p>Ordinabile solo per conf. di 10 pz. / Sold by package of 10 pcs.</p>
	<p>H9 Halogen Bulb</p> <p>12 VOLT - 65 WATT - PGJ19-5</p> <p>COS.PEL. ref. 012.H9107 SIMILAR ref. PHILIPS 12361</p> <p>Ordinabile solo per conf. di 10 pz. / Sold by package of 10 pcs.</p>
	<p>H10 Halogen Bulb</p> <p>12 VOLT - 42 WATT - PY20D</p> <p>COS.PEL. ref. 012.H1008 SIMILAR ref. -</p> <p>Ordinabile solo per conf. di 10 pz. / Sold by package of 10 pcs.</p>
	<p>H11 Halogen Bulb</p> <p>12 VOLT - 55 WATT - PGJ19-2</p> <p>COS.PEL. ref. 012.H1109 SIMILAR ref. PHILIPS 12362</p> <p>Ordinabile solo per conf. di 10 pz. / Sold by package of 10 pcs.</p>
	<p>H12 Halogen Bulb</p> <p>12 VOLT - 53 WATT - PZ20D</p> <p>COS.PEL. ref. 012.H1210 SIMILAR ref. -</p> <p>Ordinabile solo per conf. di 10 pz. / Sold by package of 10 pcs.</p>
	<p>H13 Halogen Bulb</p> <p>12 VOLT - 60/55 WATT - PJ26.4T</p> <p>COS.PEL. ref. 012.H1311 SIMILAR ref. PHILIPS 9008C1</p> <p>Ordinabile solo per conf. di 10 pz. / Sold by package of 10 pcs.</p>
	<p>9004 HB1 Halogen Bulb</p> <p>12 VOLT - 65/45 WATT - P29T</p> <p>COS.PEL. ref. 012.HB100 SIMILAR ref. -</p> <p>Ordinabile solo per conf. di 10 pz. / Sold by package of 10 pcs.</p>
	<p>9005 HB3 Halogen Bulb</p> <p>12 VOLT - 65 WATT - P20D</p> <p>COS.PEL. ref. 012.HB300 SIMILAR ref. HELLA 8GH 005 635 - 121 PHILIPS 9005</p> <p>Ordinabile solo per conf. di 10 pz. / Sold by package of 10 pcs.</p>









ALL ITEMS MENTIONED IN OUR CATALOGUE ARE NOT ORIGINAL PARTS BUT PERFECTLY INTERCHANGEABLE WITH THEM.

GOVERNING LEGISLATIONS FOR THE SALE OF OUR PRODUCTS DIFFER IN EACH COUNTRY.

INFRINGEMENTS, IF ANY, OF LOCAL LEGISLATIONS ARE RESPONSIBILITY OF THE RETAILER IN THE COUNTRY OF FINAL DISTRIBUTION.

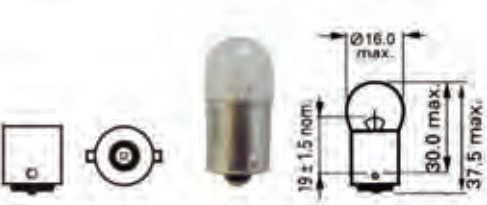

	<p>9006 HB4 Halogen Bulb 12 VOLT - 55 WATT - P22D</p> <p>COS.PEL. ref. 012.HB400 SIMILAR ref. HELLA 8GH 005 636 - 121 PHILIPS 9006</p> <p>Ordinabile solo per conf. di 10 pz. / Sold by package of 10 pcs.</p>
	<p>9007 HB5 Halogen Bulb 12 VOLT - 65/55 WATT - PX29T</p> <p>COS.PEL. ref. 012.HB500 SIMILAR ref. PHILIPS 9007C1</p> <p>Ordinabile solo per conf. di 10 pz. / Sold by package of 10 pcs.</p>
	<p>880 H27 Halogen Bulb 12 VOLT - 27 WATT - PG13 TIPO USA / USA TYPE</p> <p>COS.PEL. ref. 012.H2700 SIMILAR ref. HELLA 8GH 008 991 - 021 PHILIPS 12059C1</p> <p>Ordinabile solo per conf. di 10 pz. / Sold by package of 10 pcs.</p>
	<p>881 H27 Halogen Bulb 12 VOLT - 27 WATT - PG13 TIPO USA / USA TYPE</p> <p>COS.PEL. ref. 012.H2701 SIMILAR ref. HELLA 8GH 008 991 - 031 PHILIPS 12060C1</p> <p>Ordinabile solo per conf. di 10 pz. / Sold by package of 10 pcs.</p>
	<p>884 H27 Halogen Bulb 12 VOLT - 27 WATT - PG13 TIPO USA / USA TYPE</p> <p>COS.PEL. ref. 012.H2702 SIMILAR ref. -</p> <p>Ordinabile solo per conf. di 10 pz. / Sold by package of 10 pcs.</p>
	<p>885 H27 Halogen Bulb 12 VOLT - 50 WATT - PG13 TIPO USA / USA TYPE</p> <p>COS.PEL. ref. 012.H2703 SIMILAR ref. -</p> <p>Ordinabile solo per conf. di 10 pz. / Sold by package of 10 pcs.</p>
	<p>889 H27 Halogen Bulb 12 VOLT - 27 WATT - PG13 TIPO USA / USA TYPE</p> <p>COS.PEL. ref. 012.H2705 SIMILAR ref. -</p> <p>Ordinabile solo per conf. di 10 pz. / Sold by package of 10 pcs.</p>
	<p>892 H27 Halogen Bulb 12 VOLT - 16 WATT - PG13 TIPO USA / USA TYPE</p> <p>COS.PEL. ref. 012.H2707 SIMILAR ref. -</p> <p>Ordinabile solo per conf. di 10 pz. / Sold by package of 10 pcs.</p>

	<p>893 H27 Halogen Bulb</p> <p>12 VOLT - 37,5 WATT - PG13 TIPO USA / USA TYPE</p> <p>COS.PEL. ref. 012.H2708 SIMILAR ref. -</p> <p>Ordinabile solo per conf. di 10 pz. / Sold by package of 10 pcs.</p>
	<p>894 H27 Halogen Bulb</p> <p>12 VOLT - 37,5 WATT - PGJ13 TIPO USA / USA TYPE</p> <p>COS.PEL. ref. 012.H2709 SIMILAR ref. -</p> <p>Ordinabile solo per conf. di 10 pz. / Sold by package of 10 pcs.</p>
	<p>896 H27 Halogen Bulb</p> <p>12 VOLT - 37,5 WATT - PGJ13 TIPO USA / USA TYPE</p> <p>COS.PEL. ref. 012.H2710 SIMILAR ref. -</p> <p>Ordinabile solo per conf. di 10 pz. / Sold by package of 10 pcs.</p>
	<p>Bulb</p> <p>12 VOLT - R5W - 5 WATT - BA15S</p> <p>COS.PEL. ref. 012.R0202 SIMILAR ref. HELLA 8GA 002 071 - 121 OSRAM 5007 PHILIPS 12821</p> <p>Ordinabile solo per conf. di 10 pz. / Sold by package of 10 pcs.</p>
	<p>Bulb</p> <p>12 VOLT - R10W - 10 WATT - BA15S</p> <p>COS.PEL. ref. 012.R0203 SIMILAR ref. HELLA 8GA 002 071 - 131 OSRAM 5008 PHILIPS 12814</p> <p>Ordinabile solo per conf. di 10 pz. / Sold by package of 10 pcs.</p>
	<p>Bulb</p> <p>12 VOLT - 15CP - BA15S</p> <p>COS.PEL. ref. 012.R0204 SIMILAR ref. OSRAM 7533 PHILIPS 12401</p> <p>Ordinabile solo per conf. di 10 pz. / Sold by package of 10 pcs.</p>
	<p>Bulb</p> <p>12 VOLT - 15CP - BA15D</p> <p>COS.PEL. ref. 012.R0205 SIMILAR ref. OSRAM 7430 PHILIPS 12402</p> <p>Ordinabile solo per conf. di 10 pz. / Sold by package of 10 pcs.</p>
	<p>Bulb</p> <p>12 VOLT - P21W - 21 WATT - BA15S</p> <p>COS.PEL. ref. 012.P0601 SIMILAR ref. HELLA 8GA 002 073 - 121 OSRAM 7506 PHILIPS 12498</p> <p>Ordinabile solo per conf. di 10 pz. / Sold by package of 10 pcs.</p>

ALL ITEMS MENTIONED IN OUR CATALOGUE ARE NOT ORIGINAL PARTS BUT PERFECTLY INTERCHANGEABLE WITH THEM.

GOVERNING LEGISLATIONS FOR THE SALE OF OUR PRODUCTS DIFFER IN EACH COUNTRY.

INFRINGEMENTS, IF ANY, OF LOCAL LEGISLATIONS ARE RESPONSIBILITY OF THE RETAILER IN THE COUNTRY OF FINAL DISTRIBUTION.





Lampadine Bulbs

12 Volt



	<p>Bulb</p> <p>12 VOLT - PY21W - 21 WATT - BAU15S</p> <p>COS.PEL. ref. 012.P0603 SIMILAR ref. HELLA 8GA 006 841 - 121 OSRAM 7507 PHILIPS 12496NAB2</p> <p>Ordinabile solo per conf. di 10 pz. / Sold by package of 10 pcs.</p>
	<p>Bulb</p> <p>12 VOLT - P21/5W - 21/5 WATT - BAY15D</p> <p>COS.PEL. ref. 012.P0602 SIMILAR ref. HELLA 8GD 002 078 - 121 OSRAM 7528 PHILIPS 12499</p> <p>Ordinabile solo per conf. di 10 pz. / Sold by package of 10 pcs.</p>
	<p>Bulb</p> <p>12 VOLT - P21/4W - 21/4 WATT - BAZ15D</p> <p>COS.PEL. ref. 012.P0606 SIMILAR ref. PHILIPS 12594</p> <p>Ordinabile solo per conf. di 10 pz. / Sold by package of 10 pcs.</p>
	<p>3156 Bulb</p> <p>12 VOLT - P27W - 27 WATT - W2.5X16D</p> <p>COS.PEL. ref. 012.P0604 SIMILAR ref. OSRAM 3156</p> <p>Ordinabile solo per conf. di 10 pz. / Sold by package of 10 pcs.</p>
	<p>3157 Bulb</p> <p>12 VOLT - P27/7W - 27/7 WATT - W2.5X16Q</p> <p>COS.PEL. ref. 012.P0605 SIMILAR ref. OSRAM 3157</p> <p>Ordinabile solo per conf. di 10 pz. / Sold by package of 10 pcs.</p>
	<p>T5 Bulb</p> <p>12 VOLT - W1.2 - 1.2 WATT - W2X4.6D</p> <p>COS.PEL. ref. 012.W0501 SIMILAR ref. HELLA 8GP 002 095 - 121 OSRAM 2721 PHILIPS 12516CP</p> <p>Ordinabile solo per conf. di 10 pz. / Sold by package of 10 pcs.</p>
	<p>T5 Bulb</p> <p>12 VOLT - 2 WATT - W2X4.6D</p> <p>COS.PEL. ref. 012.W0504 SIMILAR ref. OSRAM 2722 PHILIPS 12505CP</p> <p>Ordinabile solo per conf. di 10 pz. / Sold by package of 10 pcs.</p>
	<p>T5 Bulb</p> <p>12 VOLT - W2.3W - 2.3 WATT - W2X4.6D</p> <p>COS.PEL. ref. 012.W0511 SIMILAR ref. OSRAM 2723 PHILIPS 12061CP</p> <p>Ordinabile solo per conf. di 10 pz. / Sold by package of 10 pcs.</p>

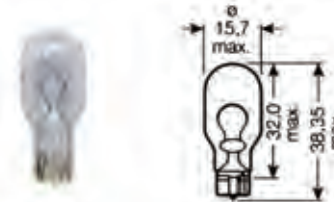
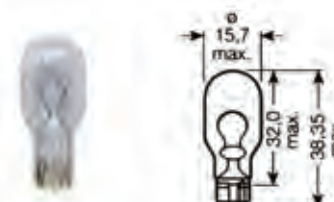
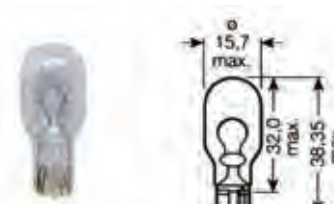
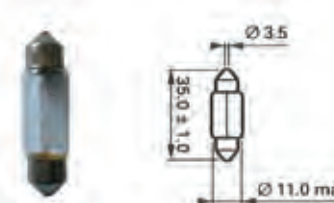
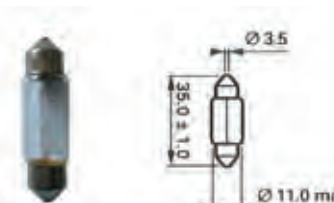

	<p>T10 Bulb</p> <p>12 VOLT - 2 WATT - W2.1X9.5D</p> <p>COS.PEL. ref. 012.W0505 SIMILAR ref. OSRAM 2820 PHILIPS 12960CP</p> <p>Ordinabile solo per conf. di 10 pz. / Sold by package of 10 pcs.</p>
	<p>T10 Bulb</p> <p>12 VOLT - W3W - 3 WATT - W2.1X9.5D</p> <p>COS.PEL. ref. 012.W0502 SIMILAR ref. HELLA 8GP 003 594 - 141 OSRAM 2821 PHILIPS 12256CP</p> <p>Ordinabile solo per conf. di 10 pz. / Sold by package of 10 pcs.</p>
	<p>T10 Bulb</p> <p>12 VOLT - 5 WATT - W2.1X9.5D</p> <p>COS.PEL. ref. 012.W0503 SIMILAR ref. HELLA 8GP 003 594 - 121 OSRAM 2825 PHILIPS 12961CP</p> <p>Ordinabile solo per conf. di 10 pz. / Sold by package of 10 pcs.</p>
	<p>T13/T15 Bulb</p> <p>12 VOLT - W16W - 16 WATT - W2.1X9.5D</p> <p>COS.PEL. ref. 012.W0506 SIMILAR ref. OSRAM 921 PHILIPS 12067CP</p> <p>Ordinabile solo per conf. di 10 pz. / Sold by package of 10 pcs.</p>
	<p>T13/T15 Bulb</p> <p>12 VOLT - 12 WATT - W2.1X9.5D</p> <p>COS.PEL. ref. 012.W0507 SIMILAR ref. -</p> <p>Ordinabile solo per conf. di 10 pz. / Sold by package of 10 pcs.</p>
	<p>T13/T15 Bulb</p> <p>12 VOLT - 12V12CP - W2.1X9.5D</p> <p>COS.PEL. ref. 012.W0508 SIMILAR ref. -</p> <p>Ordinabile solo per conf. di 10 pz. / Sold by package of 10 pcs.</p>
	<p>Bulb</p> <p>12 VOLT - 5 WATT - SV8.5</p> <p>COS.PEL. ref. 012.C0401 SIMILAR ref. HELLA 8GM 002 092 - 121 OSRAM 6418 PHILIPS 12844</p> <p>Ordinabile solo per conf. di 10 pz. / Sold by package of 10 pcs.</p>
	<p>Bulb</p> <p>12 VOLT - 10 WATT - SV8.5</p> <p>COS.PEL. ref. 012.C0402 SIMILAR ref. OSRAM 6411 PHILIPS 12854</p> <p>Ordinabile solo per conf. di 10 pz. / Sold by package of 10 pcs.</p>

ALL ITEMS MENTIONED IN OUR CATALOGUE ARE NOT ORIGINAL PARTS BUT PERFECTLY INTERCHANGEABLE WITH THEM.

GOVERNING LEGISLATIONS FOR THE SALE OF OUR PRODUCTS DIFFER IN EACH COUNTRY.

INFRINGEMENTS, IF ANY, OF LOCAL LEGISLATIONS ARE RESPONSIBILITY OF THE RETAILER IN THE COUNTRY OF FINAL DISTRIBUTION.











Lampadine Bulbs

12 Volt









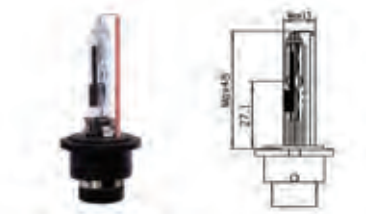
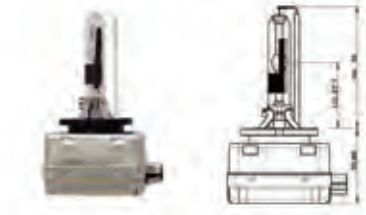
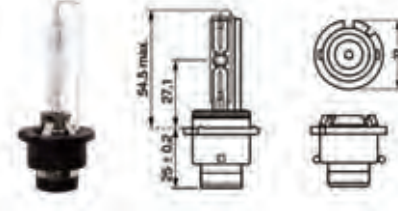
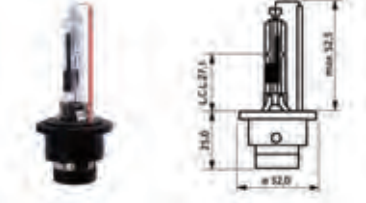

	<p>Bulb</p> <p>12 VOLT - 5 WATT - SV8.5</p> <p>COS.PEL. ref. 012.C0403 SIMILAR ref. OSRAM 6413 PHILIPS 12864</p> <p>Ordinabile solo per conf. di 10 pz. / Sold by package of 10 pcs.</p>
	<p>Bulb</p> <p>12 VOLT - 10 WATT - SV8.5</p> <p>COS.PEL. ref. 012.C0404 SIMILAR ref. OSRAM 6411 PHILIPS 12866</p> <p>Ordinabile solo per conf. di 10 pz. / Sold by package of 10 pcs.</p>
	<p>Bulb</p> <p>12 VOLT - 15 WATT - SV8.5</p> <p>COS.PEL. ref. 012.C0405 SIMILAR ref. PHILIPS 12850CP</p> <p>Ordinabile solo per conf. di 10 pz. / Sold by package of 10 pcs.</p>
	<p>Bulb</p> <p>12 VOLT - C21W - 21 WATT - SV8.5</p> <p>COS.PEL. ref. 012.C0406 SIMILAR ref. PHILIPS 12803CP</p> <p>Ordinabile solo per conf. di 10 pz. / Sold by package of 10 pcs.</p>
	<p>Bulb</p> <p>12 VOLT - 3 WATT - SV6</p> <p>COS.PEL. ref. 012.C0407 SIMILAR ref. PHILIPS 12818CP</p> <p>Ordinabile solo per conf. di 10 pz. / Sold by package of 10 pcs.</p>
	<p>Bulb</p> <p>12 VOLT - 3 WATT - SV6</p> <p>COS.PEL. ref. 012.C0408 SIMILAR ref. PHILIPS 12848CP</p> <p>Ordinabile solo per conf. di 10 pz. / Sold by package of 10 pcs.</p>
	<p>Bulb</p> <p>12 VOLT - 3 WATT - SV7-8</p> <p>COS.PEL. ref. 012.C0409 SIMILAR ref. HELLA 8GM 002 094 - 121 PHILIPS 12843</p> <p>Ordinabile solo per conf. di 10 pz. / Sold by package of 10 pcs.</p>
	<p>Bulb</p> <p>12 VOLT - 5 WATT - SV7</p> <p>COS.PEL. ref. 012.C0410 SIMILAR ref. -</p> <p>Ordinabile solo per conf. di 10 pz. / Sold by package of 10 pcs.</p>



	<p>Auto Lamps</p> <p>12 VOLT - 1.5 WATT - BA9S</p> <p>COS.PEL. ref. 012.T0302 SIMILAR ref. -</p> <p>Ordinabile solo per conf. di 10 pz. / Sold by package of 10 pcs.</p>
	<p>Auto Lamps</p> <p>12 VOLT - 2 WATT - BA9S</p> <p>COS.PEL. ref. 012.T0303 SIMILAR ref. OSRAM 3796 PHILIPS 12913</p> <p>Ordinabile solo per conf. di 10 pz. / Sold by package of 10 pcs.</p>
	<p>Auto Lamps</p> <p>12 VOLT - 3 WATT - BA9S</p> <p>COS.PEL. ref. 012.T0304 SIMILAR ref. OSRAM 3894 PHILIPS 12910CP</p> <p>Ordinabile solo per conf. di 10 pz. / Sold by package of 10 pcs.</p>
	<p>Auto Lamps</p> <p>12 VOLT - 4 WATT - BA9S</p> <p>COS.PEL. ref. 012.T0301 SIMILAR ref. HELLA 8GP 002 067 - 121 OSRAM 3893 PHILIPS 12929CP</p> <p>Ordinabile solo per conf. di 10 pz. / Sold by package of 10 pcs.</p>
	<p>Auto Lamps</p> <p>12 VOLT - 3 WATT - BA9S</p> <p>COS.PEL. ref. 012.T0305 SIMILAR ref. -</p> <p>Ordinabile solo per conf. di 10 pz. / Sold by package of 10 pcs.</p>
	<p>Auto Lamps</p> <p>12 VOLT - R2 - 45/40 WATT - P45T</p> <p>COS.PEL. ref. 012.R0201 SIMILAR ref. HELLA 8GD 002 088 - 131 OSRAM 7951 PHILIPS 12620</p> <p>Ordinabile solo per conf. di 10 pz. / Sold by package of 10 pcs.</p>
	<p>HID Lamps D1S</p> <p>12 VOLT - D1S - 35 WATT - PK32D-2</p> <p>COS.PEL. ref. 012.HID03 SIMILAR ref. HELLA 8GS 009 028 - 001 OSRAM 66144CBI PHILIPS 85410</p>
	<p>HID Lamps D2S</p> <p>12 VOLT - D2S - 35 WATT - P32D-2</p> <p>COS.PEL. ref. 012.HID01 SIMILAR ref. HELLA 8GS 007 949 - 101 OSRAM 66240CBI PHILIPS 85122</p>

	<p>HID Lamps D2R</p> <p>12 VOLT - D2R - 35 WATT - P32D-3</p> <p>COS.PEL. ref. 012.HID02</p> <p>SIMILAR ref. HELLA 8GS 007 001 - 121 OSRAM 66250CBI PHILIPS 85126</p>
	<p>HID Lamps D3R</p> <p>12 VOLT - D3R - 35 WATT - PK32D-6</p> <p>COS.PEL. ref. 012.HID08</p> <p>SIMILAR ref. OSRAM 66350 PHILIPS 42306C1</p>
	<p>HID Lamps D4S</p> <p>12 VOLT - D4S - 35 WATT - P32D-5</p> <p>COS.PEL. ref. 012.HID04</p> <p>SIMILAR ref. HELLA 8GS 007 949 - 301 OSRAM 66440 PHILIPS 42402C1</p>
	<p>HID Lamps D4R</p> <p>12 VOLT - D4R - 35 WATT - P32D-6</p> <p>COS.PEL. ref. 012.HID05</p> <p>SIMILAR ref. OSRAM 66450 PHILIPS 42406C1</p>

	<p>H1 Halogen Bulb</p> <p>24 VOLT - H1 - 55 WATT - P14.5S</p> <p>COS.PEL. ref. SIMILAR ref.</p> <p>024.H1101 HELLA 8GH 002 089 - 251</p> <p> OSRAM 64155</p> <p> PHILIPS 13258</p> <p>Ordinabile solo per conf. di 10 pz. / Sold by package of 10 pcs.</p>
	<p>H3 Halogen Bulb</p> <p>24 VOLT - H3 - 70 WATT - PK22S</p> <p>COS.PEL. ref. SIMILAR ref.</p> <p>024.H3103 HELLA 8GH 002 090 - 251</p> <p> OSRAM 64156</p> <p> PHILIPS 13336</p> <p>Ordinabile solo per conf. di 10 pz. / Sold by package of 10 pcs.</p>
	<p>H3 Halogen Bulb</p> <p>24 VOLT - H3 - 100 WATT - PK22S</p> <p>COS.PEL. ref. SIMILAR ref.</p> <p>024.H3104 PHILIPS 13628</p> <p>Ordinabile solo per conf. di 10 pz. / Sold by package of 10 pcs.</p>
	<p>H4 Halogen Bulb</p> <p>24 VOLT - H4 - 75/70 WATT - P43T</p> <p>COS.PEL. ref. SIMILAR ref.</p> <p>024.H4104 HELLA 8GJ 003 525 - 251</p> <p> OSRAM 64196</p> <p> PHILIPS 13342</p> <p>Ordinabile solo per conf. di 10 pz. / Sold by package of 10 pcs.</p>
	<p>H5 Halogen Bulb</p> <p>24 VOLT - H5 - 75/70 WATT - P45T</p> <p>COS.PEL. ref. SIMILAR ref.</p> <p>024.H5101 -</p> <p>Ordinabile solo per conf. di 10 pz. / Sold by package of 10 pcs.</p>
	<p>H7 Halogen Bulb</p> <p>24 VOLT - H7 - 70 WATT - PX26D</p> <p>COS.PEL. ref. SIMILAR ref.</p> <p>024.H7105 HELLA 8GH 007 157 - 241</p> <p> OSRAM 64215</p> <p> PHILIPS 13972</p> <p>Ordinabile solo per conf. di 10 pz. / Sold by package of 10 pcs.</p>
	<p>Bulb</p> <p>24 VOLT - R5W - 5 WATT - BA15S</p> <p>COS.PEL. ref. SIMILAR ref.</p> <p>024.R0202 HELLA 8GA 002 071 - 241</p> <p> OSRAM 5627</p> <p> PHILIPS 13821</p> <p>Ordinabile solo per conf. di 10 pz. / Sold by package of 10 pcs.</p>
	<p>Bulb</p> <p>24 VOLT - R10W - 10 WATT - BA15S</p> <p>COS.PEL. ref. SIMILAR ref.</p> <p>024.R0203 HELLA 8GA 002 071 - 251</p> <p> OSRAM 5637</p> <p> PHILIPS 13814</p> <p>Ordinabile solo per conf. di 10 pz. / Sold by package of 10 pcs.</p>

ALL ITEMS MENTIONED IN OUR CATALOGUE ARE NOT ORIGINAL PARTS BUT PERFECTLY INTERCHANGEABLE WITH THEM.
GOVERNING LEGISLATIONS FOR THE SALE OF OUR PRODUCTS DIFFER IN EACH COUNTRY.

INFRINGEMENTS, IF ANY, OF LOCAL LEGISLATIONS ARE RESPONSIBILITY OF THE RETAILER IN THE COUNTRY OF FINAL DISTRIBUTION.



	<p>Bulb</p> <p>24 VOLT - P21W - 21 WATT - BA15S</p> <p>COS.PEL. ref. 024.P0601 SIMILAR ref. HELLA 8GA 003 073 - 241 OSRAM 7511 PHILIPS 13498</p> <p>Ordinabile solo per conf. di 10 pz. / Sold by package of 10 pcs.</p>
	<p>Bulb</p> <p>24 VOLT - PY21W - 21 WATT - BAU15S</p> <p>COS.PEL. ref. 024.P0603 SIMILAR ref. HELLA 8GA 006 841 - 241 OSRAM 7510LTS PHILIPS 13496</p> <p>Ordinabile solo per conf. di 10 pz. / Sold by package of 10 pcs.</p>
	<p>Bulb</p> <p>24 VOLT - P21/5W - 21/5 WATT - BAY15D</p> <p>COS.PEL. ref. 024.P0602 SIMILAR ref. HELLA 8GD 002 078 - 241 OSRAM 7537 PHILIPS 13499</p> <p>Ordinabile solo per conf. di 10 pz. / Sold by package of 10 pcs.</p>
	<p>Bulb</p> <p>24 VOLT - 25/10W - BAY15D</p> <p>COS.PEL. ref. 024.P0604 SIMILAR ref. -</p> <p>Ordinabile solo per conf. di 10 pz. / Sold by package of 10 pcs.</p>
	<p>T5 Bulb</p> <p>24 VOLT - 1.2 WATT - W2X4.6D</p> <p>COS.PEL. ref. 024.W0501 SIMILAR ref. HELLA 8GP 002 095 - 241 OSRAM 2741 PHILIPS 13516</p> <p>Ordinabile solo per conf. di 10 pz. / Sold by package of 10 pcs.</p>
	<p>T10 Bulb</p> <p>24 VOLT - 3 WATT - W2.1X9.5D</p> <p>COS.PEL. ref. 024.W0502 SIMILAR ref. HELLA 8GP 003 594 - 241 OSRAM 2841 PHILIPS 13256</p> <p>Ordinabile solo per conf. di 10 pz. / Sold by package of 10 pcs.</p>
	<p>T10 Bulb</p> <p>24 VOLT - 2 WATT - W2.1X9.5D</p> <p>COS.PEL. ref. 024.W0504 SIMILAR ref. OSRAM 2840 PHILIPS 13960</p> <p>Ordinabile solo per conf. di 10 pz. / Sold by package of 10 pcs.</p>
	<p>T10 Bulb</p> <p>24 VOLT - 5 WATT - W2.1X9.5D</p> <p>COS.PEL. ref. 024.W0503 SIMILAR ref. HELLA 8GP 003 594 - 251 OSRAM 2845 PHILIPS 13961</p> <p>Ordinabile solo per conf. di 10 pz. / Sold by package of 10 pcs.</p>

 	<p>T13/T15 Bulb</p> <p>24 VOLT - 24V12CP - W2.1X9.5D</p> <p>COS.PEL. ref. 024.W0505 SIMILAR ref. -</p> <p>Ordinabile solo per conf. di 10 pz. / Sold by package of 10 pcs.</p>
 	<p>Bulb</p> <p>24 VOLT - C5W - 5 WATT - SV8.5</p> <p>COS.PEL. ref. 024.C0401 SIMILAR ref. HELLA 8GM 002 092 - 241 OSRAM 6423 PHILIPS 13844</p> <p>Ordinabile solo per conf. di 10 pz. / Sold by package of 10 pcs.</p>
 	<p>Bulb</p> <p>24 VOLT - 10 WATT - SV8.5</p> <p>COS.PEL. ref. 024.C0402 SIMILAR ref. PHILIPS 13854</p> <p>Ordinabile solo per conf. di 10 pz. / Sold by package of 10 pcs.</p>
 	<p>Bulb</p> <p>24 VOLT - 5 WATT - SV8.5</p> <p>COS.PEL. ref. 024.C0403 SIMILAR ref. OSRAM 6427 PHILIPS 13864</p> <p>Ordinabile solo per conf. di 10 pz. / Sold by package of 10 pcs.</p>
 	<p>Bulb</p> <p>24 VOLT - 10 WATT - SV8.5</p> <p>COS.PEL. ref. 024.C0404 SIMILAR ref. OSRAM 6429 PHILIPS 13866</p> <p>Ordinabile solo per conf. di 10 pz. / Sold by package of 10 pcs.</p>
 	<p>Bulb</p> <p>24 VOLT - 21 WATT - SV8.5</p> <p>COS.PEL. ref. 024.C0406 SIMILAR ref. -</p> <p>Ordinabile solo per conf. di 10 pz. / Sold by package of 10 pcs.</p>
 	<p>Bulb</p> <p>24 VOLT - 3 WATT - SV6</p> <p>COS.PEL. ref. 024.C0407 SIMILAR ref. PHILIPS 13818</p> <p>Ordinabile solo per conf. di 10 pz. / Sold by package of 10 pcs.</p>
 	<p>Bulb</p> <p>24 VOLT - 3 WATT - SV6</p> <p>COS.PEL. ref. 024.C0408 SIMILAR ref. PHILIPS 13992</p> <p>Ordinabile solo per conf. di 10 pz. / Sold by package of 10 pcs.</p>

ALL ITEMS MENTIONED IN OUR CATALOGUE ARE NOT ORIGINAL PARTS BUT PERFECTLY INTERCHANGEABLE WITH THEM.

GOVERNING LEGISLATIONS FOR THE SALE OF OUR PRODUCTS DIFFER IN EACH COUNTRY.

INFRINGEMENTS, IF ANY, OF LOCAL LEGISLATIONS ARE RESPONSIBILITY OF THE RETAILER IN THE COUNTRY OF FINAL DISTRIBUTION.



	<p>Bulb</p> <p>24 VOLT - 3 WATT - SV7-8</p> <p>COS.PEL. ref. 024.C0409 SIMILAR ref. HELLA 8GM 002 094 - 241 OSRAM 6430</p> <p>Ordinabile solo per conf. di 10 pz. / Sold by package of 10 pcs.</p>
	<p>Bulb</p> <p>24 VOLT - 5 WATT - SV7-8</p> <p>COS.PEL. ref. 024.C0410 SIMILAR ref. -</p> <p>Ordinabile solo per conf. di 10 pz. / Sold by package of 10 pcs.</p>
	<p>Auto Lamp</p> <p>24 VOLT - 2 WATT - BA9S</p> <p>COS.PEL. ref. 024.T0302 SIMILAR ref. OSRAM 3797 PHILIPS 13913</p> <p>Ordinabile solo per conf. di 10 pz. / Sold by package of 10 pcs.</p>
	<p>Auto Lamp</p> <p>24 VOLT - 3 WATT - BA9S</p> <p>COS.PEL. ref. 024.T0303 SIMILAR ref. PHILIPS 13910</p> <p>Ordinabile solo per conf. di 10 pz. / Sold by package of 10 pcs.</p>
	<p>Auto Lamp</p> <p>24 VOLT - 4 WATT - BA9S</p> <p>COS.PEL. ref. 024.T0301 SIMILAR ref. HELLA 8GP 002 067 - 241 OSRAM 3930 PHILIPS 13929</p> <p>Ordinabile solo per conf. di 10 pz. / Sold by package of 10 pcs.</p>
	<p>Auto Lamp</p> <p>24 VOLT - 3 WATT - BA9S</p> <p>COS.PEL. ref. 024.T0304 SIMILAR ref. -</p> <p>Ordinabile solo per conf. di 10 pz. / Sold by package of 10 pcs.</p>
	<p>Auto Lamp</p> <p>24 VOLT - 21 WATT - BAY9S</p> <p>COS.PEL. ref. 024.H2421 SIMILAR ref. PHILIPS 24356</p> <p>Ordinabile solo per conf. di 10 pz. / Sold by package of 10 pcs.</p>
	<p>Auto Lamp</p> <p>24 VOLT - R2 - 55/50 WATT - P45T</p> <p>COS.PEL. ref. 024.R0201 SIMILAR ref. OSRAM 7952 PHILIPS 13620</p> <p>Ordinabile solo per conf. di 10 pz. / Sold by package of 10 pcs.</p>



Parti di ricambio adattabili a:
Spare parts suitable to:









PARTI DI RICAMBIO ADATTABILI A : **COS.RE**
 SPARE PARTS SUITABLE TO :

 <p>Altri colori disponibili su ordinazione / Other colour against specific order / (min. 3 pcs)</p>	<p>Mascotte</p> <p>FODERA SEDILE - SERIE TRE POSTI PANCHETTA - PASSAGGIO CINTURA</p> <p>SEAT COVER - THREE SEATS SERIES BENCH SEAT WITH CUT OUT FOR SAFETY BELT</p> <p>COS.PEL. ref. 7001.00027</p> <p>Colore standard cod. 56 / Standard colour cod. 56</p>
 <p>Altri colori disponibili su ordinazione / Other colour against specific order / (min. 3 pcs)</p>	<p>Midlum 2007</p> <p>FODERA SEDILE - LATO GUIDA POGGIATESTA INCORPORATO</p> <p>SEAT COVER - DRIVER'S SEAT BUILT-IN HEAD RESTRAINT</p> <p>COS.PEL. ref. 7001.00013</p> <p>Colore standard cod. 56 / Standard colour cod. 56</p>
 <p>Altri colori disponibili su ordinazione / Other colour against specific order / (min. 3 pcs)</p>	<p>Midlum 2007</p> <p>FODERA SEDILE - SERIE DUE POSTI POGGIATESTA INCORPORATI</p> <p>SEAT COVER - TWO SEATS SERIES BUILT-IN HEAD RESTRAINT</p> <p>COS.PEL. ref. 7001.00014</p> <p>Colore standard cod. 56 / Standard colour cod. 56</p>
 <p>Altri colori disponibili su ordinazione / Other colour against specific order / (min. 3 pcs)</p>	<p>Midlum 2007</p> <p>FODERA SEDILE - SERIE TRE POSTI SEDILE GUIDA : POGGIATESTA INCORPORATO - PANCHETTA SDOPPIATA CON 2 POGGIATESTA</p> <p>SEAT COVER - THREE SEATS SERIES DRIVERS'S SEAT : BUILT-IN HEAD RESTRAINT - SEPARATED BENCH SEAT WITH 2 HEAD RESTRAINT</p> <p>COS.PEL. ref. 7001.00015</p> <p>Colore standard cod. 56 / Standard colour cod. 56</p>
 <p>PVC : Altri colori disponibili su ordinazione / Other colour against specific order / (min. 3 pcs)</p>	<p>Midlum 2007</p> <p>TAPPETO FLOOR MAT</p> <p>COS.PEL. ref. 7001.00016 PVC Colore standard cod. 38 / Standard colour cod. 38</p> <p>COS.PEL. ref. 7001.00017 MOQUETTES / CARPETED Colore unico cod. 41 / One colour only cod. 41</p>
 <p>Altri colori disponibili su ordinazione / Other colour against specific order / (min. 3 pcs)</p>	<p>Magnum 2002</p> <p>FODERA SEDILE - LATO GUIDA POGGIATESTA INCORPORATO</p> <p>SEAT COVER - DRIVER'S SEAT BUILT-IN HEAD RESTRAINT</p> <p>COS.PEL. ref. 7001.00000</p> <p>Colore standard cod. 56 / Standard colour cod. 56</p>
 <p>Altri colori disponibili su ordinazione / Other colour against specific order / (min. 3 pcs)</p>	<p>Magnum 2002</p> <p>FODERA SEDILE - SERIE DUE POSTI POGGIATESTA INCORPORATI</p> <p>SEAT COVERS - TWO SEATS SERIES BUILT-IN HEAD RESTRAINT</p> <p>COS.PEL. ref. 7001.00001</p> <p>Colore standard cod. 56 / Standard colour cod. 56</p>
 <p>Altri colori disponibili su ordinazione / Other colour against specific order / (min. 3 pcs)</p>	<p>Magnum 2002</p> <p>FODERA SEDILE - SERIE DUE POSTI SEDILE GUIDA : POGGIATESTA INCORPORATO - SEDILE DESTRO : POLTRONCINA GIREVOLE</p> <p>SEAT COVER - TWO SEATS SERIES DRIVER'S SIDE : BUILT-IN HEAD RESTRAINT - RH SIDE : MOVABLE SEAT</p> <p>COS.PEL. ref. 7001.00002</p> <p>Colore standard cod. 56 / Standard colour cod. 56</p>

 <p>PVC : Altri colori disponibili su ordinazione / Other colour against specific order / (min. 3 pcs)</p>	<p>Magnum 2002</p> <p>TAPPETO PVC FLOOR MAT PVC</p> <p>COS.PEL. ref. 7001.00003 PVC - SEDILE FISSO / FIXED SEAT Colore standard cod. 38 / Standard colour cod. 38</p> <p>COS.PEL. ref. 7001.00004 PVC - SEDILE GIREVOLE / MOVABLE SEAT Colore standard cod. 38 / Standard colour cod. 38</p>
 <p>Disponibile in un solo colore / One colour only</p>	<p>Magnum 2002</p> <p>TAPPETO MOQUETTES FLOOR MAT CARPETED</p> <p>COS.PEL. ref. 7001.00005 MOQUETTES / CARPETED - SEDILE FISSO / FIXED SEAT Colore unico cod. 41 / One colour only cod. 41</p> <p>COS.PEL. ref. 7001.00006 MOQUETTES / CARPETED - SEDILE GIREVOLE / MOVABLE SEAT Colore unico cod. 41 / One colour only cod. 41</p>
 <p>Altri colori disponibili su ordinazione / Other colour against specific order / (min. 3 pcs)</p>	<p>Premium</p> <p>FODERA SEDILE - LATO GUIDA POGGIATESTA INCORPORATO</p> <p>SEAT COVER - DRIVER'S SEAT BUILT-IN HEAD RESTRAINT</p> <p>COS.PEL. ref. 7001.00007</p> <p>Colore standard cod. 56 / Standard colour cod. 56</p>
 <p>Altri colori disponibili su ordinazione / Other colour against specific order / (min. 3 pcs)</p>	<p>Premium</p> <p>FODERA SEDILE - SERIE DUE POSTI POGGIATESTA INCORPORATI</p> <p>SEAT COVERS - SERIES TWO SEATS BUILT-IN HEAD RESTRAINT</p> <p>COS.PEL. ref. 7001.00008</p> <p>Colore standard cod. 56 / Standard colour cod. 56</p>
 <p>PVC : Altri colori disponibili su ordinazione / Other colour against specific order / (min. 3 pcs)</p>	<p>Premium</p> <p>TAPPETO FLOOR MAT</p> <p>COS.PEL. ref. 7001.00009 PVC Colore standard cod. 38 / Standard colour cod. 38</p> <p>COS.PEL. ref. 7001.00010 MOQUETTES / CARPETED Colore unico cod. 41 / One colour only cod. 41</p>
 <p>PVC : Altri colori disponibili su ordinazione / Other colour against specific order / (min. 3 pcs)</p>	<p>Premium</p> <p>COPRICOFANO PVC - TERMOSALDATO - CABINA LUNGA</p> <p>DASH COVER PVC - HEAT-SEALED ITEM FOR LONG CAB</p> <p>COS.PEL. ref. 7001.00011 PVC Colore standard cod. 38 / Standard colour cod. 38</p>
 <p>PVC : Altri colori disponibili su ordinazione / Other colour against specific order / (min. 3 pcs)</p>	<p>Premium 2005</p> <p>COPRICOFANO PVC - TERMOSALDATO - CABINA LUNGA</p> <p>DASH COVER PVC - HEAT-SEALED PVC ITEM FOR LONG CAB</p> <p>COS.PEL. ref. 7001.00012 PVC Colore standard cod. 38 / Standard colour cod. 38</p>
 <p>Colore unico / One colour only</p>	<p>Premium 1a serie</p> <p>SEDUTA SEDILE COMPOSTA DA IMBOTTITURA + FODERA</p> <p>SEAT CUSHION FORMED FROM CUSHIONING + COVER</p> <p>COS.PEL. ref. 7001.10000</p> <p>Colore unico cod. 59 / One colour only cod. 59</p>







PARTI DI RICAMBIO ADATTABILI A : **COS.RE**
 SPARE PARTS SUITABLE TO :

 <p>Altri colori disponibili su ordinazione / Other colour against specific order / (min. 3 pcs)</p>	<p>T Lunga distanza 2014 (pianale piatto / cabina alta)</p> <p>FODERA SEDILE - LATO GUIDA POGGIATESTA INCORPORATO - PASSAGGIO CINTURA - PASSAGGIO BRACCIOLI</p> <p>SEAT COVER - DRIVER'S SEAT BUILT-IN HEAD RESTRAINT - CUT OUT FOR SAFETY BELT - CUT OUT FOR ARMREST</p> <p>COS.PEL. ref. 7001.00018</p> <p>Colore standard cod. 56 / Standard colour cod. 56</p>
 <p>Altri colori disponibili su ordinazione / Other colour against specific order / (min. 3 pcs)</p>	<p>T Lunga distanza 2014 (pianale piatto / cabina alta)</p> <p>FODERA SEDILE - SERIE DUE POSTI POGGIATESTA INCORPORATI - PASSAGGIO CINTURA - PASSAGGIO BRACCIOLI</p> <p>SEAT COVERS - TWO SEATS SERIES BUILT-IN HEAD RESTRAINT - CUT OUT FOR SAFETY BELT - CUT OUT FOR ARMREST</p> <p>COS.PEL. ref. 7001.00019</p> <p>Colore standard cod. 56 / Standard colour cod. 56</p>
 <p>PVC : Altri colori disponibili su ordinazione / Other colour against specific order / (min. 3 pcs)</p>	<p>T Lunga distanza 2014 (pianale piatto / cabina alta)</p> <p>COPRICOFANO PVC - CAMBIO AUTOMATICO - TUTTO PIANO</p> <p>DASH COVER PVC - AUTOMATIC GEARBOX - ALL PLAIN</p> <p>COS.PEL. ref. 7001.00020 PVC Colore standard cod. 38 / Standard colour cod. 38</p>
 <p>Altri colori disponibili su ordinazione / Other colour against specific order / (min. 3 pcs)</p>	<p>T Lunga dist. 2014 (tunnel mot. 20 cm / cab. bassa)</p> <p>FODERA SEDILE - LATO GUIDA POGGIATESTA INCORPORATO - PASSAGGIO CINTURA - PASSAGGIO BRACCIOLI</p> <p>SEAT COVER - DRIVER'S SEAT BUILT-IN HEAD RESTRAINT - CUT OUT FOR SAFETY BELT - CUT OUT FOR ARMREST</p> <p>COS.PEL. ref. 7001.00021</p> <p>Colore standard cod. 56 / Standard colour cod. 56</p>
 <p>Altri colori disponibili su ordinazione / Other colour against specific order / (min. 3 pcs)</p>	<p>T Lunga dist. 2014 (tunnel mot. 20 cm / cab. bassa)</p> <p>FODERA SEDILE - SERIE DUE POSTI POGGIATESTA INCORPORATI - PASSAGGIO CINTURA - PASSAGGIO BRACCIOLI</p> <p>SEAT COVERS - TWO SEATS SERIES BUILT-IN HEAD RESTRAINT - CUT OUT FOR SAFETY BELT - CUT OUT FOR ARMREST</p> <p>COS.PEL. ref. 7001.00022</p> <p>Colore standard cod. 56 / Standard colour cod. 56</p>
 <p>PVC : Altri colori disponibili su ordinazione / Other colour against specific order / (min. 3 pcs)</p>	<p>T Lunga dist. 2014 (tunnel mot. 20 cm / cab. bassa)</p> <p>COPRICOFANO CAMBIO AUTOMATICO</p> <p>DASH COVER AUTOMATIC GEARBOX</p> <p>COS.PEL. ref. 7001.00023 PVC Colore standard cod. 38 / Standard colour cod. 38</p> <p>COS.PEL. ref. 7001.00024 MOQUETTES / CARPETED Colore unico cod. 41 / One colour only cod. 41</p>
 <p>PVC : Altri colori disponibili su ordinazione / Other colour against specific order / (min. 3 pcs)</p>	<p>T Lunga dist. 2014 (tunnel mot. 20 cm / cab. bassa)</p> <p>TAPPETO FLOOR MAT</p> <p>COS.PEL. ref. 7001.00025 PVC Colore standard cod. 38 / Standard colour cod. 38</p> <p>COS.PEL. ref. 7001.00026 MOQUETTES / CARPETED Colore unico cod. 41 / One colour only cod. 41</p>
 <p>Colore unico / One colour only</p>	<p>Premium / Midlum 2002 / Euro 6 (pogg.inc.)</p> <p>SEDUTA SEDILE COMPOSTA DA IMBOTTITURA + FODERA</p> <p>SEAT CUSHION FORMED FROM CUSHIONING + COVER</p> <p>COS.PEL. ref. 7001.10001</p> <p>Colore unico cod. 59 / One colour only cod. 59</p>

 <p>Altri colori disponibili su ordinazione / Other colour against specific order / (min. 3 pcs)</p>	<p>F-M 4 Euro 6 2014</p> <p>FODERA SEDILE - LATO GUIDA POGGIATESTA INCORPORATO - PASSAGGIO CINTURA - BRACCIOLO E LEVA</p> <p>SEAT COVER - DRIVER'S SEAT BUILT-IN HEAD RESTRAINT - CUT OUT FOR SAFETY BELT - ARMREST AND GEAR LEVER</p> <p>COS.PEL. ref. 7002.00022</p> <p>Colore standard cod. 56 / Standard colour cod. 56</p>
 <p>Altri colori disponibili su ordinazione / Other colour against specific order / (min. 3 pcs)</p>	<p>F-M 4 Euro 6 2014</p> <p>FODERA SEDILE - SERIE DUE POSTI POGGIATESTA INCORPORATO - PASSAGGIO CINTURA - BRACCIOLO E LEVA</p> <p>SEAT COVERS - TWO SEATS SERIES BUILT-IN HEAD RESTRAINT - CUT OUT FOR SAFETY BELT - ARMREST AND GEAR LEVER</p> <p>COS.PEL. ref. 7002.00023</p> <p>Colore standard cod. 56 / Standard colour cod. 56</p>
 <p>Altri colori disponibili su ordinazione / Other colour against specific order / (min. 3 pcs)</p>	<p>F-M 4 Euro 6 2014</p> <p>FODERA SEDILE - SERIE DUE POSTI SX : POGGIATESTA INCORPORATO - PASSAGGIO CINTURA - BRACCIOLO E LEVA - DX : SENZA PASSAGGIO CINTURA</p> <p>SEAT COVERS - TWO SEATS SERIES S.SX BUILT-IN HEAD RESTRAINT, CUT OUT FOR SAF. BELT, ARMREST AND GEAR LEVER - RH W/O TRANSFER BELT</p> <p>COS.PEL. ref. 7002.00024</p> <p>Colore standard cod. 56 / Standard colour cod. 56</p>
 <p>Altri colori disponibili su ordinazione / Other colour against specific order / (min. 3 pcs)</p>	<p>F-M 4 Euro 6 2014</p> <p>FODERA SEDILE - SERIE DUE POSTI SENZA PASSAGGIO CINTURA, SOLO PASSAGGIO BRACCIOLO E LEVA</p> <p>SEAT COVERS - TWO SEATS SERIES WITHOUT SAFETY BELT CUT OUT, ONLY ARMREST CUT OUT AND GEAR LEVER</p> <p>COS.PEL. ref. 7002.00025</p> <p>Colore standard cod. 56 / Standard colour cod. 56</p>
 <p>PVC : Altri colori disponibili su ordinazione / Other colour against specific order / (min. 3 pcs)</p>	<p>F-M 4 Euro 6 2014</p> <p>TAPPETO FLOOR MAT</p> <p>COS.PEL. ref. 7002.00026 PVC Colore standard cod. 38 / Standard colour cod. 38</p> <p>COS.PEL. ref. 7002.00027 MOQUETTES / CARPETED Colore unico cod. 41 / One colour only cod. 41</p>
 <p>Altri colori disponibili su ordinazione / Other colour against specific order / (min. 3 pcs)</p>	<p>F-H</p> <p>FODERA SEDILE - LATO GUIDA CON POGGIATESTA</p> <p>SEAT COVER - DRIVER'S SEAT WITH HEAD RESTRAINT</p> <p>COS.PEL. ref. 7002.00000</p> <p>Colore standard cod. 56 / Standard colour cod. 56</p>
 <p>Altri colori disponibili su ordinazione / Other colour against specific order / (min. 3 pcs)</p>	<p>F-H</p> <p>FODERA SEDILE - SERIE DUE POSTI CON POGGIATESTA</p> <p>SEAT COVERS - TWO SEATS SERIES WITH HEAD RESTRAINT</p> <p>COS.PEL. ref. 7002.00001</p> <p>Colore standard cod. 56 / Standard colour cod. 56</p>
 <p>PVC : Altri colori disponibili su ordinazione / Other colour against specific order / (min. 3 pcs)</p>	<p>F-H</p> <p>TAPPETO FLOOR MAT</p> <p>COS.PEL. ref. 7002.00006 PVC Colore standard cod. 38 / Standard colour cod. 38</p> <p>COS.PEL. ref. 7002.00007 MOQUETTES / CARPETED Colore unico cod. 41 / One colour only cod. 41</p>

PARTI DI RICAMBIO ADATTABILI A : **COS.VO**
 SPARE PARTS SUITABLE TO :

 <p>PVC : Altri colori disponibili su ordinazione / Other colour against specific order / (min. 3 pcs)</p>	<p>F-H in piano</p> <p>COPRICOFANO PVC - TERMOSALDATO - CABINA LUNGA DASH COVER PVC - HEAT-SEALED ITEM - LONG CAB COS.PEL. ref. 7002.00010 PVC - MANUALE / MANUAL Colore standard cod. 38 / Standard colour cod. 38</p> <p>COS.PEL. ref. 7002.00011 PVC - AUTOMATICO / AUTOMATIC Colore standard cod. 38 / Standard colour cod. 38</p>
 <p>PVC : Altri colori disponibili su ordinazione / Other colour against specific order / (min. 3 pcs)</p>	<p>F-H cofano alto</p> <p>COPRICOFANO PVC - TERMOSALDATO - CABINA LUNGA - MANUALE DASH COVER PVC - HEAT-SEALED ITEM FOR LONG CAB - MANUAL COS.PEL. ref. 7002.00012 PVC - MANUALE / MANUAL Colore standard cod. 38 / Standard colour cod. 38</p>
 <p>Colore unico / One colour only</p>	<p>F-H 2002</p> <p>SEDUTA SEDILE COMPOSTA DA IMBOTTITURA + FODERA SEAT CUSHION FORMED FROM CUSHIONING + COVER COS.PEL. ref. 7002.10000 Colore unico cod. 3 / One colour only cod. 3</p>
 <p>Altri colori disponibili su ordinazione / Other colour against specific order / (min. 3 pcs)</p>	<p>F-H 2002</p> <p>FODERA SEDILE - LATO GUIDA POGGIATESTA INCORPORATO SEAT COVER - DRIVER'S SEAT BUILT-IN HEAD RESTRAINT COS.PEL. ref. 7002.00002 Colore standard cod. 56 / Standard colour cod. 56</p>
 <p>Altri colori disponibili su ordinazione / Other colour against specific order / (min. 3 pcs)</p>	<p>F-H 2002</p> <p>FODERA SEDILE - SERIE DUE POSTI POGGIATESTA INCORPORATI SEAT COVERS - TWO SEATS SERIES BUILT-IN HEAD RESTRAINT COS.PEL. ref. 7002.00003 Colore standard cod. 56 / Standard colour cod. 56</p>
 <p>Altri colori disponibili su ordinazione / Other colour against specific order / (min. 3 pcs)</p>	<p>F-H 2002</p> <p>FODERA SEDILE - LATO GUIDA POGGIATESTA INCORPORATO - PASSAGGIO CINTURA SEAT COVER - DRIVER'S SEAT BUILT-IN HEAD RESTRAINT - CUT OUT FOR SAFETY BELT COS.PEL. ref. 7002.00004 Colore standard cod. 56 / Standard colour cod. 56</p>
 <p>Altri colori disponibili su ordinazione / Other colour against specific order / (min. 3 pcs)</p>	<p>F-H 2002</p> <p>FODERA SEDILE - SERIE DUE POSTI POGGIATESTA INCORPORATI - PASSAGGIO CINTURA SEAT COVERS - TWO SEATS SERIES BUILT-IN HEAD RESTRAINT - CUT OUT FOR SAFETY BELT COS.PEL. ref. 7002.00005 Colore standard cod. 56 / Standard colour cod. 56</p>
 <p>PVC : Altri colori disponibili su ordinazione / Other colour against specific order / (min. 3 pcs)</p>	<p>F-H 2002</p> <p>TAPPETO</p> <p>FLOOR MAT CON SCANSO LATERALE COS.PEL. ref. 7002.00008 PVC Colore standard cod. 38 / Standard colour cod. 38</p> <p>COS.PEL. ref. 7002.00009 MOQUETTES / CARPETED Colore unico cod. 41 / One colour only cod. 41</p>

 <p>Altri colori disponibili su ordinazione / Other colour against specific order / (min. 3 pcs)</p>	<p>F-H 4 Euro 6 2014</p> <p>FODERA SEDILE - LATO GUIDA POGGIATESTA INCORPORATO - PASSAGGIO CINTURA - BRACCIOLO - LEVA</p> <p>SEAT COVER - DRIVER'S SEAT BUILT-IN HEAD RESTRAINT - CUT OUT FOR SAFETY BELT - ARMREST AND GEAR LEVER</p> <p>COS.PEL. ref. 7002.00013</p> <p>Colore standard cod. 56 / Standard colour cod. 56</p>
 <p>Altri colori disponibili su ordinazione / Other colour against specific order / (min. 3 pcs)</p>	<p>F-H 4 Euro 6 2014</p> <p>FODERA SEDILE - SERIE DUE POSTI POGGIATESTA INCORPORATO - PASSAGGIO CINTURA - BRACCIOLO - LEVA</p> <p>SEAT COVERS - TWO SEATS SERIES BUILT-IN HEAD RESTRAINT - CUT OUT FOR SAFETY BELT - ARMREST AND GEAR LEVER</p> <p>COS.PEL. ref. 7002.00014</p> <p>Colore standard cod. 56 / Standard colour cod. 56</p>
 <p>Altri colori disponibili su ordinazione / Other colour against specific order / (min. 3 pcs)</p>	<p>F-H 4 Euro 2014</p> <p>FODERA SEDILE - SERIE DUE POSTI SED.SX POGGIATESTA INCORPORATI, PASSAGGIO CINTURA, BRACCIOLO E LEVA - SED.DX SENZA PASSAGG. CINTURA</p> <p>SEAT COVERS - TWO SEATS SERIES S.SX BUILT-IN HEAD RESTRAINT, CUT OUT FOR SAF. BELT, ARMREST AND GEAR LEVER - RH W/O TRANSFER BELT</p> <p>COS.PEL. ref. 7002.00015</p> <p>Colore standard cod. 56 / Standard colour cod. 56</p>
 <p>Altri colori disponibili su ordinazione / Other colour against specific order / (min. 3 pcs)</p>	<p>F-H 4 Euro 2014</p> <p>FODERA SEDILE - SERIE DUE POSTI SENZA PASSAGGIO CINTURA, SOLO PASSAGGIO BRACCIOLO E LEVA</p> <p>SEAT COVERS - TWO SEATS SERIES WITHOUT SAFETY BELT CUT OUT, ONLY ARMREST CUT OUT AND GEAR LEVER</p> <p>COS.PEL. ref. 7002.00016</p> <p>Colore standard cod. 56 / Standard colour cod. 56</p>
 <p>PVC : Altri colori disponibili su ordinazione / Other colour against specific order / (min. 3 pcs)</p>	<p>F-H 4 Euro 6 2014</p> <p>COPRIPIANALE PVC - CAMBIO AUTOMATICO - PIANO</p> <p>PLAIN DASH COVER PVC - WITH AUTOMATIC GEARBOX</p> <p>COS.PEL. ref. 7002.00017 PVC Colore standard cod. 38 / Standard colour cod. 38</p>
 <p>PVC : Altri colori disponibili su ordinazione / Other colour against specific order / (min. 3 pcs)</p>	<p>F-H 4 Euro 2014</p> <p>TAPPETO CENTRALE - CAMBIO AUTOMATICO</p> <p>FLOOR MAT CENTRAL - FOR AUTOMATIC GEARBOX</p> <p>COS.PEL. ref. 7002.00018 PVC Colore standard cod. 38 / Standard colour cod. 38</p> <p>COS.PEL. ref. 7002.00019 MOQUETTES / CARPETED Colore unico cod. 41 / One colour only cod. 41</p>
 <p>PVC : Altri colori disponibili su ordinazione / Other colour against specific order / (min. 3 pcs)</p>	<p>F-H 4 Euro 6 2014</p> <p>TAPPETO CON SCANCO LATERALE</p> <p>FLOOR MAT</p> <p>COS.PEL. ref. 7002.00020 PVC Colore standard cod. 38 / Standard colour cod. 38</p> <p>COS.PEL. ref. 7002.00021 MOQUETTES / CARPETED Colore unico cod. 41 / One colour only cod. 41</p>

PARTI DI RICAMBIO ADATTABILI A : **COS.SCA**
 SPARE PARTS SUITABLE TO :

 <p>Colore unico / One colour only</p>	<p>Serie R</p> <p>SEDUTA SEDILE COMPOSTA DA IMBOTTITURA + FODERA</p> <p>SEAT CUSHION FORMED FROM CUSHIONING + COVER</p> <p>COS.PEL. ref. 7003.10001</p> <p>Colore unico cod. 23 / One colour only cod. 23</p>
 <p>Altri colori disponibili su ordinazione / Other colour against specific order / (min. 3 pcs)</p>	<p>142m/143m/144m/113/95h</p> <p>FODERA SEDILE - LATO GUIDA CON POGGIATESTA E PASSAGGIO CINTURA</p> <p>SEAT COVER - DRIVER'S SEAT WITH HEAD RESTRAINT AND CUT OUT FOR SAFETY BELT</p> <p>COS.PEL. ref. 7003.00000</p> <p>Colore standard cod. 56 / Standard colour cod. 56</p>
 <p>Altri colori disponibili su ordinazione / Other colour against specific order / (min. 3 pcs)</p>	<p>142m/143m/144m/113/95h</p> <p>FODERA SEDILE - SERIE DUE POSTI CON POGGIATESTA E PASSAGGIO CINTURA</p> <p>SEAT COVERS - TWO SEATS SERIES WITH HEAD RESTRAINT AND CUT OUT FOR SAFETY BELT</p> <p>COS.PEL. ref. 7003.00001</p> <p>Colore standard cod. 56 / Standard colour cod. 56</p>
 <p>Altri colori disponibili su ordinazione / Other colour against specific order / (min. 3 pcs)</p>	<p>142m/143m/144m/113/95h</p> <p>FODERA SEDILE - LATO GUIDA POGGIATESTA INCORPORATO</p> <p>SEAT COVER - DRIVER'S SEAT BUILT-IN HEAD RESTRAINT</p> <p>COS.PEL. ref. 7003.00002</p> <p>Colore standard cod. 56 / Standard colour cod. 56</p>
 <p>Altri colori disponibili su ordinazione / Other colour against specific order / (min. 3 pcs)</p>	<p>142m/143m/144m/113/95h</p> <p>FODERA SEDILE - SERIE DUE POSTI POGGIATESTA INCORPORATI</p> <p>SEAT COVERS - TWO SEATS SERIES BUILT-IN HEAD RESTRAINT</p> <p>COS.PEL. ref. 7003.00003</p> <p>Colore standard cod. 56 / Standard colour cod. 56</p>
 <p>PVC : Altri colori disponibili su ordinazione / Other colour against specific order / (min. 3 pcs)</p>	<p>144m</p> <p>TAPPETO CON SCANSO LATERALE</p> <p>FLOOR MAT</p> <p>COS.PEL. ref. 7003.00004 PVC Colore standard cod. 38 / Standard colour cod. 38</p> <p>COS.PEL. ref. 7003.00005 MOQUETTES / CARPETED Colore unico cod. 41 / One colour only cod. 41</p>
 <p>PVC : Altri colori disponibili su ordinazione / Other colour against specific order / (min. 3 pcs)</p>	<p>144m</p> <p>COPRICOFANO PVC - TERMOSALDATO - CABINA LUNGA</p> <p>DASH COVER HEAT-SEALED PVC ITEM FOR LONG CAB</p> <p>COS.PEL. ref. 7003.00006 PVC - CAMBIO MANUALE / MANUAL GEARBOX Colore standard cod. 38 / Standard colour cod. 38</p> <p>COS.PEL. ref. 7003.00007 PVC - CAMBIO AUTOMATICO / AUTOMATIC GEARBOX Colore standard cod. 38 / Standard colour cod. 38</p>
 <p>Colore unico / One colour only</p>	<p>144</p> <p>SEDUTA SEDILE COMPOSTA DA IMBOTTITURA + FODERA</p> <p>SEAT CUSHION FORMED FROM CUSHIONING + COVER</p> <p>COS.PEL. ref. 7003.10000</p> <p>Colore unico cod. 23 / One colour only cod. 23</p>

 <p>Altri colori disponibili su ordinazione / Other colour against specific order / (min. 3 pcs)</p>	<p>Serie R</p> <p>FODERA SEDILE - LATO GUIDA POGGIATESTA INCORPORATO</p> <p>SEAT COVER - DRIVER'S SEAT BUILT-IN HEAD RESTRAINT</p> <p>COS.PEL. ref. 7003.00008</p> <p>Colore standard cod. 56 / Standard colour cod. 56</p>
 <p>Altri colori disponibili su ordinazione / Other colour against specific order / (min. 3 pcs)</p>	<p>Serie R</p> <p>FODERA SEDILE - SERIE DUE POSTI POGGIATESTA INCORPORATI</p> <p>SEAT COVERS - TWO SEATS SERIES BUILT-IN HEAD RESTRAINT</p> <p>COS.PEL. ref. 7003.00009</p> <p>Colore standard cod. 56 / Standard colour cod. 56</p>
 <p>Altri colori disponibili su ordinazione / Other colour against specific order / (min. 3 pcs)</p>	<p>Serie R</p> <p>FODERA SEDILE - SERIE DUE POSTI SED. SX : POGGIATESTA INCORPORATO - SED. DX : SCHIENALE BASSO CON POGGIATESTA</p> <p>SEAT COVERS - TWO SEATS SERIES LH SIDE : BUILT-IN HEAD RESTRAINT - RH SIDE : WITH LOW-BACK SEAT WITH HEAD RESTRAINT</p> <p>COS.PEL. ref. 7003.00010</p> <p>Colore standard cod. 56 / Standard colour cod. 56</p>
 <p>PVC : Altri colori disponibili su ordinazione / Other colour against specific order / (min. 3 pcs)</p>	<p>Serie R</p> <p>TAPPETO PVC - CON SCANSO LATERALE FLOOR MAT PVC</p> <p>COS.PEL. ref. 7003.00011 PVC - CAMBIO MANUALE / MANUAL GEARBOX Colore standard cod. 38 / Standard colour cod. 38</p> <p>COS.PEL. ref. 7003.00012 PVC - CAMBIO AUTOMATICO / AUTOMATIC GEARBOX Colore standard cod. 38 / Standard colour cod. 38</p>
 <p>Colore unico / One colour only</p>	<p>Serie R</p> <p>TAPPETO MOQUETTES - CON SCANSO LATERALE FLOOR MAT CARPETED</p> <p>COS.PEL. ref. 7003.00013 MOQUETTES / CARPETED - CAMBIO MANUALE / MANUAL GEARBOX Colore unico cod. 41 / One colour only cod. 41</p> <p>COS.PEL. ref. 7003.00014 MOQUETTES / CARPETED - CAMBIO AUTOMATICO / AUTOMATIC GEARBOX Colore unico cod. 41 / One colour only cod. 41</p>
 <p>PVC : Altri colori disponibili su ordinazione / Other colour against specific order / (min. 3 pcs)</p>	<p>Serie R</p> <p>COPRICOFANO PVC - TERMOSALDATO - CABINA LUNGA DASH COVER HEAT-SEALED PVC ITEM FOR LONG CAB</p> <p>COS.PEL. ref. 7003.00015 PVC - CAMBIO MANUALE / MANUAL GEARBOX Colore standard cod. 38 / Standard colour cod. 38</p> <p>COS.PEL. ref. 7003.00016 PVC - CAMBIO AUTOMATICO / AUTOMATIC GEARBOX Colore standard cod. 38 / Standard colour cod. 38</p>
 <p>Colore unico / One colour only</p>	<p>Serie R</p> <p>SEDUTA SEDILE COMPOSTA DA IMBOTTITURA + FODERA</p> <p>SEAT CUSHION FORMED FROM CUSHIONING + COVER</p> <p>COS.PEL. ref. 7003.10001</p> <p>Colore unico cod. 23 / One colour only cod. 23</p>

PARTI DI RICAMBIO ADATTABILI A : **COS.DA**
 SPARE PARTS SUITABLE TO :

 <p>Altri colori disponibili su ordinazione / Other colour against specific order / (min. 3 pcs)</p>	<p>Cf 85</p> <p>FODERA SEDILE - LATO GUIDA POGGIATESTA INCORPORATO</p> <p>SEAT COVER - DRIVER'S SEAT BUILT-IN HEAD RESTRAINT</p> <p>COS.PEL. ref. 7004.00012</p> <p>Colore standard cod. 56 / Standard colour cod. 56</p>
 <p>Altri colori disponibili su ordinazione / Other colour against specific order / (min. 3 pcs)</p>	<p>Cf 85</p> <p>FODERA SEDILE - SERIE DUE POSTI POGGIATESTA INCORPORATI</p> <p>SEAT COVERS - TWO SEATS SERIES BUILT-IN HEAD RESTRAINT</p> <p>COS.PEL. ref. 7004.00013</p> <p>Colore standard cod. 56 / Standard colour cod. 56</p>
 <p>PVC : Altri colori disponibili su ordinazione / Other colour against specific order / (min. 3 pcs)</p>	<p>Cf 85</p> <p>TAPPETO FLOOR MAT</p> <p>COS.PEL. ref. 7004.00014 PVC Colore standard cod. 38 / Standard colour cod. 38</p> <p>COS.PEL. ref. 7004.00015 MOQUETTES / CARPETED Colore unico cod. 41 / One colour only cod. 41</p>
 <p>PVC : Altri colori disponibili su ordinazione / Other colour against specific order / (min. 3 pcs)</p>	<p>Cf 85</p> <p>COPRICOFANO PVC - TERMOSALDATO - CABINA LUNGA - CAMBIO MANUALE</p> <p>DASH COVER HEAT-SEALED PVC ITEM FOR LONG CAB</p> <p>COS.PEL. ref. 7004.00016 PVC Colore standard cod. 38 / Standard colour cod. 38</p>
 <p>Altri colori disponibili su ordinazione / Other colour against specific order / (min. 3 pcs)</p>	<p>Cf Euro 6 (2014)</p> <p>FODERA SEDILE - LATO GUIDA POGGIATESTA INCORPORATO - PASSAGGIO CINTURA - PASSAGGIO BRACCIOLO</p> <p>SEAT COVER - DRIVER'S SEAT BUILT-IN HEAD RESTRAINT - CUT OUT FOR SAFETY BELT - CUT OUT FOR ARMREST</p> <p>COS.PEL. ref. 7004.00017</p> <p>Colore standard cod. 56 / Standard colour cod. 56</p>
 <p>Altri colori disponibili su ordinazione / Other colour against specific order / (min. 3 pcs)</p>	<p>45 / 55</p> <p>FODERA SEDILE - LATO GUIDA</p> <p>SEAT COVER - DRIVER'S SEAT</p> <p>COS.PEL. ref. 7004.00000</p> <p>Colore standard cod. 56 / Standard colour cod. 56</p>
 <p>Altri colori disponibili su ordinazione / Other colour against specific order / (min. 3 pcs)</p>	<p>Cf Euro 6 (2014)</p> <p>FODERA SEDILE - SERIE DUE POSTI POGGIATESTA INCORPORATI - PASSAGGIO CINTURA - PASSAGGIO BRACCIOLI</p> <p>SEAT COVERS - TWO SEATS SERIES BUILT-IN HEAD RESTRAINT - CUT OUT FOR SAFETY BELT - CUT OUT FOR ARMREST</p> <p>COS.PEL. ref. 7004.00018</p> <p>Colore standard cod. 56 / Standard colour cod. 56</p>
 <p>Altri colori disponibili su ordinazione / Other colour against specific order / (min. 3 pcs)</p>	<p>45 / 55</p> <p>FODERA SEDILE - SERIE TRE POSTI</p> <p>SEAT COVERS - THREE SEATS SERIES</p> <p>COS.PEL. ref. 7004.00001</p> <p>Colore standard cod. 56 / Standard colour cod. 56</p>

 <p>PVC : Altri colori disponibili su ordinazione / Other colour against specific order / (min. 3 pcs)</p>	<p>45 / 55</p> <p>TAPPETO FLOOR MAT</p> <p>COS.PEL. ref. 7004.00002 PVC Colore standard cod. 38 / Standard colour cod. 38</p> <p>COS.PEL. ref. 7004.00003 MOQUETTES / CARPETED Colore unico cod. 41 / One colour only cod. 41</p>
 <p>PVC : Altri colori disponibili su ordinazione / Other colour against specific order / (min. 3 pcs)</p>	<p>Cf Euro 6 (2014)</p> <p>TAPPETO FLOOR MAT</p> <p>COS.PEL. ref. 7004.00019 PVC Colore standard cod. 38 / Standard colour cod. 38</p> <p>COS.PEL. ref. 7004.00020 MOQUETTES / CARPETED Colore unico cod. 41 / One colour only cod. 41</p>
 <p>Altri colori disponibili su ordinazione / Other colour against specific order / (min. 3 pcs)</p>	<p>Xf 105 (2006)</p> <p>FODERA SEDILE - LATO GUIDA POGGIATESTA INCORPORATO</p> <p>SEAT COVER - DRIVER'S SEAT BUILT-IN HEAD RESTRAINT</p> <p>COS.PEL. ref. 7004.00021</p> <p>Colore standard cod. 56 / Standard colour cod. 56</p>
 <p>Altri colori disponibili su ordinazione / Other colour against specific order / (min. 3 pcs)</p>	<p>Xf 95</p> <p>FODERA SEDILE - LATO GUIDA POGGIATESTA INCORPORATO</p> <p>SEAT COVER - DRIVER'S SEAT BUILT-IN HEAD RESTRAINT</p> <p>COS.PEL. ref. 7004.00004</p> <p>Colore standard cod. 56 / Standard colour cod. 56</p>
 <p>Altri colori disponibili su ordinazione / Other colour against specific order / (min. 3 pcs)</p>	<p>Xf 105 (2006)</p> <p>FODERA SEDILE - SERIE DUE POSTI POGGIATESTA INCORPORATI</p> <p>SEAT COVERS - TWO SEATS SERIES BUILT-IN HEAD RESTRAINT</p> <p>COS.PEL. ref. 7004.00022</p> <p>Colore standard cod. 56 / Standard colour cod. 56</p>
 <p>Altri colori disponibili su ordinazione / Other colour against specific order / (min. 3 pcs)</p>	<p>Xf 95</p> <p>FODERA SEDILE - SERIE DUE POSTI POGGIATESTA INCORPORATI</p> <p>SEAT COVERS - TWO SEATS SERIES BUILT-IN HEAD RESTRAINT</p> <p>COS.PEL. ref. 7004.00005</p> <p>Colore standard cod. 56 / Standard colour cod. 56</p>
 <p>Altri colori disponibili su ordinazione / Other colour against specific order / (min. 3 pcs)</p>	<p>Xf Euro 6 (2014)</p> <p>FODERA SEDILE - LATO GUIDA POGGIATESTA INCORPORATO - PASSAGGIO CINTURA - PASSAGGIO BRACCIOLO</p> <p>SEAT COVER - DRIVER'S SEAT BUILT-IN HEAD RESTRAINT - CUT OUT FOR SAFETY BELT - CUT OUT FOR ARMREST</p> <p>COS.PEL. ref. 7004.00027</p> <p>Colore standard cod. 56 / Standard colour cod. 56</p>
 <p>PVC : Altri colori disponibili su ordinazione / Other colour against specific order / (min. 3 pcs)</p>	<p>Xf 95</p> <p>TAPPETO FLOOR MAT</p> <p>COS.PEL. ref. 7004.00006 PVC Colore standard cod. 38 / Standard colour cod. 38</p> <p>COS.PEL. ref. 7004.00007 MOQUETTES / CARPETED Colore unico cod. 41 / One colour only cod. 41</p>









PARTI DI RICAMBIO ADATTABILI A : **COS.DA**
 SPARE PARTS SUITABLE TO :

 <p>PVC : Altri colori disponibili su ordinazione / Other colour against specific order / (min. 3 pcs)</p>	<p>Xf 105 (2006)</p> <p>TAPPETO FLOOR MAT</p> <p>COS.PEL. ref. 7004.00023 PVC Colore standard cod. 38 / Standard colour cod. 38</p> <p>COS.PEL. ref. 7004.00024 MOQUETTES / CARPETED Colore unico cod. 41 / One colour only cod. 41</p>
 <p>Altri colori disponibili su ordinazione / Other colour against specific order / (min. 3 pcs)</p>	<p>Xf Euro 6 (2014)</p> <p>FODERA SEDILE - SERIE DUE POSTI POGGIATESTA INCORPORATI - PASSAGGIO CINTURA - PASSAGGIO BRACCIOLI</p> <p>SEAT COVERS - TWO SEATS SERIES BUILT-IN HEAD RESTRAINT - CUT OUT FOR SAFETY BELT - CUT OUT FOR ARMREST</p> <p>COS.PEL. ref. 7004.00028</p> <p>Colore standard cod. 56 / Standard colour cod. 56</p>
 <p>PVC : Altri colori disponibili su ordinazione / Other colour against specific order / (min. 3 pcs)</p>	<p>Xf 95 (2006)</p> <p>TAPPETO FLOOR MAT</p> <p>COS.PEL. ref. 7004.00008 PVC Colore standard cod. 38 / Standard colour cod. 38</p>
 <p>PVC : Altri colori disponibili su ordinazione / Other colour against specific order / (min. 3 pcs)</p>	<p>Xf 105 (2006)</p> <p>COPRICOFANO PVC - TERMOSALDATO - CABINA LUNGA</p> <p>DASH COVER HEAT-SEALED PVC ITEM FOR LONG CAB</p> <p>COS.PEL. ref. 7004.00025 PVC - CAMBIO MANUALE / MANUAL GEARBOX Colore standard cod. 38 / Standard colour cod. 38</p> <p>COS.PEL. ref. 7004.00026 PVC - CAMBIO AUTOMATICO / AUTOMATIC GEARBOX Colore standard cod. 38 / Standard colour cod. 38</p>
 <p>PVC : Altri colori disponibili su ordinazione / Other colour against specific order / (min. 3 pcs)</p>	<p>Xf Euro 6 (2014)</p> <p>COPRICOFANO CAMBIO AUTOMATICO</p> <p>DASH COVER AUTOMATIC GEARBOX</p> <p>COS.PEL. ref. 7004.00029 PVC - CAMBIO AUTOMATICO / AUTOMATIC GEARBOX Colore standard cod. 38 / Standard colour cod. 38</p> <p>COS.PEL. ref. 7004.00030 MOQUETTES / CARPETED - CAMBIO AUTOMATICO / AUTOMATIC GEARBOX Colore unico cod. 41 / One colour only cod. 41</p>
 <p>PVC : Altri colori disponibili su ordinazione / Other colour against specific order / (min. 3 pcs)</p>	<p>Xf 95 (2006)</p> <p>TAPPETO FLOOR MAT</p> <p>COS.PEL. ref. 7004.00009 MOQUETTES / CARPETED Colore unico cod. 41 / One colour only cod. 41</p>
 <p>PVC : Altri colori disponibili su ordinazione / Other colour against specific order / (min. 3 pcs)</p>	<p>Xf Euro 6 (2014)</p> <p>TAPPETO FLOOR MAT</p> <p>COS.PEL. ref. 7004.00031 PVC Colore standard cod. 38 / Standard colour cod. 38</p>
 <p>Colore unico / One colour only</p>	<p>105 / Euro 6</p> <p>SEDUTA SEDILE COMPOSTA DA IMBOTTITURA + FODERA</p> <p>SEAT CUSHION FORMED FROM CUSHIONING + COVER</p> <p>COS.PEL. ref. 7004.10000</p> <p>Colore unico cod. 56 / One colour only cod. 56</p>









 <p>PVC : Altri colori disponibili su ordinazione / Other colour against specific order / (min. 3 pcs)</p>	<p>Xf 95</p> <p>COPRICOFANO PVC - TERMOSALDATO - CABINA LUNGA</p> <p>DASH COVER HEAT-SEALED PVC ITEM FOR LONG CAB</p> <p>COS.PEL. ref. 7004.00010 PVC Colore standard cod. 38 / Standard colour cod. 38</p>
 <p>PVC : Altri colori disponibili su ordinazione / Other colour against specific order / (min. 3 pcs)</p>	<p>Xf Euro 6 (2014)</p> <p>TAPPETO</p> <p>FLOOR MAT</p> <p>COS.PEL. ref. 7004.00032 MOQUETTES / CARPETED Colore unico cod. 41 / One colour only cod. 41</p>
 <p>PVC : Altri colori disponibili su ordinazione / Other colour against specific order / (min. 3 pcs)</p>	<p>Xf 95 (2006)</p> <p>COPRICOFANO PVC - TERMOSALDATO - CABINA LUNGA</p> <p>DASH COVER HEAT-SEALED PVC ITEM FOR LONG CAB</p> <p>COS.PEL. ref. 7004.00011 PVC Colore standard cod. 38 / Standard colour cod. 38</p>

PARTI DI RICAMBIO ADATTABILI A : **COS.ME**
 SPARE PARTS SUITABLE TO :

 <p>Altri colori disponibili su ordinazione / Other colour against specific order / (min. 3 pcs)</p>	<p>Sprinter 2014</p> <p>FODERA SEDILE - LATO GUIDA CON POGGIATESTA</p> <p>SEAT COVER - DRIVER'S SEAT WITH HEAD RESTRAINT</p> <p>COS.PEL. ref. 7005.00053</p> <p>Colore standard cod. 56 / Standard colour cod. 56</p>
 <p>Altri colori disponibili su ordinazione / Other colour against specific order / (min. 3 pcs)</p>	<p>Sprinter 2014</p> <p>FODERA SEDILE - SERIE DUE POSTI CON POGGIATESTA</p> <p>SEAT COVERS - TWO SEATS SERIES WITH HEAD RESTRAINT</p> <p>COS.PEL. ref. 7005.00054</p> <p>Colore standard cod. 56 / Standard colour cod. 56</p>
 <p>Altri colori disponibili su ordinazione / Other colour against specific order / (min. 3 pcs)</p>	<p>Sprinter 2014</p> <p>FODERA SEDILE - SERIE TRE POSTI CON PANCHETTA UNICA RIBALTABILE - CON PORTAOGGETTI E POGGIATESTA</p> <p>SEAT COVERS - THREE SEATS SERIES WITH ONE RECLINING BENCH SEAT - WITH GLOVE COMPARTMENT AND HEAD RESTRAINT</p> <p>COS.PEL. ref. 7005.00055</p> <p>Colore standard cod. 56 / Standard colour cod. 56</p>
 <p>PVC : Altri colori disponibili su ordinazione / Other colour against specific order / (min. 3 pcs)</p>	<p>Sprinter 2014</p> <p>TAPPETO FLOOR MAT</p> <p>COS.PEL. ref. 7005.00056 PVC Colore standard cod. 38 / Standard colour cod. 38</p> <p>COS.PEL. ref. 7005.00057 MOQUETTES / CARPETED Colore unico cod. 41 / One colour only cod. 41</p>
 <p>Colore unico / One colour only</p>	<p>Sprinter</p> <p>SEDUTA SEDILE COMPOSTA DA IMBOTTITURA + FODERA</p> <p>SEAT CUSHION FORMED FROM CUSHIONING + COVER</p> <p>COS.PEL. ref. 7005.10000</p> <p>Colore unico cod. 56 / One colour only cod. 56</p>
 <p>Altri colori disponibili su ordinazione / Other colour against specific order / (min. 3 pcs)</p>	<p>Sprinter 2006</p> <p>FODERA SEDILE - LATO GUIDA</p> <p>SEAT COVER - DRIVER'S SEAT</p> <p>COS.PEL. ref. 7005.00047</p> <p>Colore standard cod. 56 / Standard colour cod. 56</p>
 <p>Altri colori disponibili su ordinazione / Other colour against specific order / (min. 3 pcs)</p>	<p>Sprinter 2006</p> <p>FODERA SEDILE - SERIE TRE POSTI CON PANCHETTA SDOPPIATA CON PORTAOGGETTI</p> <p>SEAT COVERS - THREE SEATS SERIES TREE SEATS SEPARATED BENCH SEATS WITH GLOVE COMPARTMENT</p> <p>COS.PEL. ref. 7005.00048</p> <p>Colore standard cod. 56 / Standard colour cod. 56</p>
 <p>Altri colori disponibili su ordinazione / Other colour against specific order / (min. 3 pcs)</p>	<p>Sprinter 2006</p> <p>FODERA SEDILE - SERIE DUE POSTI</p> <p>SEAT COVERS - TWO SEATS SERIES</p> <p>COS.PEL. ref. 7005.00049</p> <p>Colore standard cod. 56 / Standard colour cod. 56</p>

 <p>Altri colori disponibili su ordinazione / Other colour against specific order / (min. 3 pcs)</p>	<p>Sprinter 2006</p> <p>FODERA SEDILE - SERIE SEI+UNO POSTI SED.SX : PANCHETTA 2 POSTI SDOPPIATA CON PORTAOGGETTI - PANCHETTA POSTERIORE 4 POSTI SEAT COVERS - SIX+ONE SEATS SERIES LH SIDE : 2 SEPARATED PLACE BENCH SEAT WITH GLOVE COMPARTMENT - BACK BENCH SEAT 4 PLACES COS.PEL. ref. 7005.00050</p> <p>Colore standard cod. 56 / Standard colour cod. 56</p>
 <p>PVC : Altri colori disponibili su ordinazione / Other colour against specific order / (min. 3 pcs)</p>	<p>Sprinter 2006</p> <p>TAPPETO FLOOR MAT</p> <p>COS.PEL. ref. 7005.00051 PVC Colore standard cod. 38 / Standard colour cod. 38</p> <p>COS.PEL. ref. 7005.00052 MOQUETTES / CARPETED Colore unico cod. 41 / One colour only cod. 41</p>
 <p>Altri colori disponibili su ordinazione / Other colour against specific order / (min. 3 pcs)</p>	<p>Atego</p> <p>FODERA SEDILE - LATO GUIDA POGGIATESTA INCORPORATO - PASSAGGIO CINTURA SEAT COVER - DRIVER'S SEAT BUILT-IN HEAD RESTRAINT - CUT OUT FOR SAFETY BELT COS.PEL. ref. 7005.00029</p> <p>Colore standard cod. 56 / Standard colour cod. 56</p>
 <p>Altri colori disponibili su ordinazione / Other colour against specific order / (min. 3 pcs)</p>	<p>Atego</p> <p>FODERA SEDILE - SERIE DUE POSTI SED.SX : CON CINTURA E POGGIATESTA - SED.DX : SENZA CINTURA, CON POGGIATESTA SEAT COVERS - TWO SEATS SERIES LH S. : BUILT-IN HEAD RESTRAINT , CUT OUT FOR SAFETY BELT - RH S. : WITHOUT CUT OUT FOR SAFETY BELT COS.PEL. ref. 7005.00030</p> <p>Colore standard cod. 56 / Standard colour cod. 56</p>
 <p>Altri colori disponibili su ordinazione / Other colour against specific order / (min. 3 pcs)</p>	<p>Atego</p> <p>FODERA SEDILE - SERIE DUE POSTI SEDILI CON CINTURE SEAT COVERS - TWO SEATS SERIES WITH SAFETY BELTS COS.PEL. ref. 7005.00031</p> <p>Colore standard cod. 56 / Standard colour cod. 56</p>
 <p>Altri colori disponibili su ordinazione / Other colour against specific order / (min. 3 pcs)</p>	<p>Atego</p> <p>FODERA SEDILE - SERIE TRE POSTI 2 SEDILI CON CINTURE E SEDILE CENTRALE FISSO SEAT COVERS - THREE SEATS SERIES 2 SEATS WITH SAFETY BELTS AND FIXED SEAT IN THE MIDDLE COS.PEL. ref. 7005.00032</p> <p>Colore standard cod. 56 / Standard colour cod. 56</p>
 <p>Altri colori disponibili su ordinazione / Other colour against specific order / (min. 3 pcs)</p>	<p>Atego</p> <p>FODERA SEDILE - SERIE TRE POSTI 3 SEDILI SENZA CINTURE SEAT COVERS - THREE SEATS SERIES 3 SEATS WITHOUT SAFETY BELTS COS.PEL. ref. 7005.00033</p> <p>Colore standard cod. 56 / Standard colour cod. 56</p>
 <p>Altri colori disponibili su ordinazione / Other colour against specific order / (min. 3 pcs)</p>	<p>Atego</p> <p>FODERA SEDILE - SERIE TRE POSTI 3 SEDILI CON CINTURE SEAT COVERS - THREE SEATS SERIES 3 SEATS WITH SAFETY BELTS COS.PEL. ref. 7005.00034</p> <p>Colore standard cod. 56 / Standard colour cod. 56</p>

PARTI DI RICAMBIO ADATTABILI A : **COS.ME**
 SPARE PARTS SUITABLE TO :

 <p>PVC : Altri colori disponibili su ordinazione / Other colour against specific order / (min. 3 pcs)</p>	<p>Atego</p> <p>TAPPETO FLOOR MAT</p> <p>COS.PEL. ref. 7005.00035 PVC Colore standard cod. 38 / Standard colour cod. 38</p> <p>COS.PEL. ref. 7005.00036 MOQUETTES / CARPETED Colore unico cod. 41 / One colour only cod. 41</p>
 <p>PVC : Altri colori disponibili su ordinazione / Other colour against specific order / (min. 3 pcs)</p>	<p>Atego</p> <p>COPRICOFANO PVC - TERMOSALDATO DASH COVER HEAT-SEALED PVC ITEM</p> <p>COS.PEL. ref. 7005.00037 PVC - CABINA CORTA / SHORT CAB Colore standard cod. 38 / Standard colour cod. 38</p> <p>COS.PEL. ref. 7005.00038 PVC - CABINA LUNGA / LONG CAB Colore standard cod. 38 / Standard colour cod. 38</p>
 <p>Altri colori disponibili su ordinazione / Other colour against specific order / (min. 3 pcs)</p>	<p>Actros</p> <p>FODERA SEDILE - LATO GUIDA POGGIATESTA INCORPORATO - PASSAGGIO CINTURA</p> <p>SEAT COVER - DRIVER'S SEAT BUILT-IN HEAD RESTRAINT - CUT OUT FOR SAFETY BELT</p> <p>COS.PEL. ref. 7005.00000</p> <p>Colore standard cod. 56 / Standard colour cod. 56</p>
 <p>Altri colori disponibili su ordinazione / Other colour against specific order / (min. 3 pcs)</p>	<p>Actros</p> <p>FODERA SEDILE - SERIE DUE POSTI SED. SX : CON CINTURA E POGGIATESTA - SED. DX : SENZA CINTURA</p> <p>SEAT COVERS - TWO SEATS SERIES LH SIDE : WITH HEAD RESTRAINT AND CUT OUT FOR SAFETY BELT - RH SIDE : WITHOUT SAFETY BELT</p> <p>COS.PEL. ref. 7005.00001</p> <p>Colore standard cod. 56 / Standard colour cod. 56</p>
 <p>Altri colori disponibili su ordinazione / Other colour against specific order / (min. 3 pcs)</p>	<p>Axor</p> <p>FODERA SEDILE - LATO GUIDA CON POGGIATESTA - PASSAGGIO CINTURA</p> <p>SEAT COVER - DRIVER'S SEAT WITH SAFETY-BELT AND HEAD RESTRAINT</p> <p>COS.PEL. ref. 7005.00039</p> <p>Colore standard cod. 56 / Standard colour cod. 56</p>
 <p>Altri colori disponibili su ordinazione / Other colour against specific order / (min. 3 pcs)</p>	<p>Actros</p> <p>FODERA SEDILE - SERIE DUE POSTI CON CINTURE , SEDILE DESTRO E SINISTRO</p> <p>SEAT COVERS - TWO SEATS SERIES WITH SAFETY BELT, RIGHT AND LEFT SEAT</p> <p>COS.PEL. ref. 7005.00002</p> <p>Colore standard cod. 56 / Standard colour cod. 56</p>
 <p>Altri colori disponibili su ordinazione / Other colour against specific order / (min. 3 pcs)</p>	<p>Axor</p> <p>FODERA SEDILE - SERIE DUE POSTI SED.SX : CON CINTURA E POGGIATESTA - SED.DX : SENZA CINTURA, CON POGGIATESTA</p> <p>SEAT COVERS - TWO SEATS SERIES LH SEAT : HEAD RESTRAINT , CUT OUT FOR SAFETY BELT - RH SEAT : WITHOUT CUT OUT FOR SAFETY BELT</p> <p>COS.PEL. ref. 7005.00040</p> <p>Colore standard cod. 56 / Standard colour cod. 56</p>
 <p>Altri colori disponibili su ordinazione / Other colour against specific order / (min. 3 pcs)</p>	<p>Actros</p> <p>FODERA SEDILE - LATO GUIDA GRAMMER - POGGIATESTA INCORPORATO</p> <p>SEAT COVER - DRIVER'S SEAT GRAMMER - BUILT-IN HEAD RESTRAINT</p> <p>COS.PEL. ref. 7005.00003</p> <p>Colore standard cod. 56 / Standard colour cod. 56</p>

 <p>Altri colori disponibili su ordinazione / Other colour against specific order / (min. 3 pcs)</p>	<p>Axor</p> <p>FODERA SEDILE - SERIE DUE POSTI SEDILI CON CINTURE</p> <p>SEAT COVERS - TWO SEATS SERIES WITH SAFETY BELTS</p> <p>COS.PEL. ref. 7005.00041</p> <p>Colore standard cod. 56 / Standard colour cod. 56</p>
 <p>Altri colori disponibili su ordinazione / Other colour against specific order / (min. 3 pcs)</p>	<p>Actros</p> <p>FODERA SEDILE DUE POSTI SED. SX SEDILE GRAMMER - POGGIATESTA INCORPORATI</p> <p>SEAT COVERS - SERIES TWO SEATS GRAMMER DRIVER'S SEAT - BUILT-IN HEAD RESTRAINT</p> <p>COS.PEL. ref. 7005.00004</p> <p>Colore standard cod. 56 / Standard colour cod. 56</p>
 <p>Altri colori disponibili su ordinazione / Other colour against specific order / (min. 3 pcs)</p>	<p>Axor 2011</p> <p>FODERA SEDILE - SERIE TRE POSTI TRE POSTI SINGOLI</p> <p>SEAT COVERS - THREE SEATS SERIES 3 SINGLE SEATS</p> <p>COS.PEL. ref. 7005.00042</p> <p>Colore standard cod. 56 / Standard colour cod. 56</p>
 <p>Altri colori disponibili su ordinazione / Other colour against specific order / (min. 3 pcs)</p>	<p>Actros</p> <p>FODERA SEDILE - SERIE DUE POSTI DUE SEDILI GRAMMER - POGGIATESTA INCORPORATI</p> <p>SEAT COVERS - TWO SEATS SERIES 2 GRAMMER SEATS - BUILT-IN HEAD RESTRAINT</p> <p>COS.PEL. ref. 7005.00005</p> <p>Colore standard cod. 56 / Standard colour cod. 56</p>
 <p>PVC : Altri colori disponibili su ordinazione / Other colour against specific order / (min. 3 pcs)</p>	<p>Actros</p> <p>TAPPETO FLOOR MAT</p> <p>COS.PEL. ref. 7005.00006 PVC Colore standard cod. 38 / Standard colour cod. 38</p> <p>COS.PEL. ref. 7005.00007 MOQUETTES / CARPETED Colore unico cod. 41 / One colour only cod. 41</p>
 <p>PVC : Altri colori disponibili su ordinazione / Other colour against specific order / (min. 3 pcs)</p>	<p>Axor</p> <p>TAPPETO FLOOR MAT</p> <p>COS.PEL. ref. 7005.00043 PVC Colore standard cod. 38 / Standard colour cod. 38</p> <p>COS.PEL. ref. 7005.00044 MOQUETTES / CARPETED Colore unico cod. 41 / One colour only cod. 41</p>
 <p>PVC : Altri colori disponibili su ordinazione / Other colour against specific order / (min. 3 pcs)</p>	<p>Actros Mega Space</p> <p>TAPPETO FLOOR MAT</p> <p>COS.PEL. ref. 7005.00008 PVC Colore standard cod. 38 / Standard colour cod. 38</p> <p>COS.PEL. ref. 7005.00009 MOQUETTES / CARPETED Colore unico cod. 41 / One colour only cod. 41</p>
 <p>PVC : Altri colori disponibili su ordinazione / Other colour against specific order / (min. 3 pcs)</p>	<p>Axor</p> <p>COPRICOFANO PVC - TERMOSALDATO DASH COVER HEAT-SEALED PVC ITEM</p> <p>COS.PEL. ref. 7005.00045 PVC - CABINA CORTA / SHORT CAB Colore standard cod. 38 / Standard colour cod. 38</p> <p>COS.PEL. ref. 7005.00046 PVC - CABILA LUNGA / LONG CAB Colore standard cod. 38 / Standard colour cod. 38</p>

ALL ITEMS MENTIONED IN OUR CATALOGUE ARE NOT ORIGINAL PARTS BUT PERFECTLY INTERCHANGEABLE WITH THEM.

GOVERNING LEGISLATIONS FOR THE SALE OF OUR PRODUCTS DIFFER IN EACH COUNTRY.

INFRINGEMENTS, IF ANY, OF LOCAL LEGISLATIONS ARE RESPONSIBILITY OF THE RETAILER IN THE COUNTRY OF FINAL DISTRIBUTION.



PARTI DI RICAMBIO ADATTABILI A : **COS.ME**
 SPARE PARTS SUITABLE TO :

 <p>PVC : Altri colori disponibili su ordinazione / Other colour against specific order / (min. 3 pcs)</p>	<p>Actros</p> <p>COPRICOFANO PVC - TERMOSALDATO - CABINA CORTA</p> <p>DASH COVER PVC HEAT-SEALED FOR SHORT CAB</p> <p>COS.PEL. ref. 7005.00010 PVC Colore standard cod. 38 / Standard colour cod. 38</p>
 <p>PVC : Altri colori disponibili su ordinazione / Other colour against specific order / (min. 3 pcs)</p>	<p>Actros</p> <p>COPRICOFANO PVC - TERMOSALDATO - CABINA LUNGA</p> <p>DASH COVER HEAT-SEALED PVC ITEM FOR LONG CAB</p> <p>COS.PEL. ref. 7005.00011 PVC - CON CASSETTO / WITH DRAWER Colore standard cod. 38 / Standard colour cod. 38</p> <p>COS.PEL. ref. 7005.00012 PVC - SENZA CASSETTO / WITHOUT DRAWER Colore standard cod. 38 / Standard colour cod. 38</p>
 <p>Altri colori disponibili su ordinazione / Other colour against specific order / (min. 3 pcs)</p>	<p>Actros Mp2</p> <p>FODERA SEDILE - LATO GUIDA POGGIATESTA INCORPORATO - PASSAGGIO CINTURA</p> <p>SEAT COVER - DRIVER'S SEAT BUILT-IN HEAD RESTRAINT - CUT OUT FOR SAFETY BELT</p> <p>COS.PEL. ref. 7005.00013 Colore standard cod. 56 / Standard colour cod. 56</p>
 <p>Altri colori disponibili su ordinazione / Other colour against specific order / (min. 3 pcs)</p>	<p>Actros Mp2</p> <p>FODERA SEDILE - SERIE DUE POSTI POGGIATESTA INCORPORATI - PASSAGGIO CINTURA</p> <p>SEAT COVERS - TWO SEATS SERIES BUILT-IN HEAD RESTRAINT - CUT OUT FOR SAFETY BELT</p> <p>COS.PEL. ref. 7005.00014 Colore standard cod. 56 / Standard colour cod. 56</p>
 <p>Altri colori disponibili su ordinazione / Other colour against specific order / (min. 3 pcs)</p>	<p>Actros Mp2</p> <p>FODERA SEDILE - SERIE DUE POSTI SED. SX : POGGIATESTA INCORPORATO - SED. DX : POLTRONCINA</p> <p>SEAT COVERS - TWO SEATS SERIES LH SEAT : BUILT-IN LEFT HEAD RESTRAINT - SEAT ON THE RIGHT</p> <p>COS.PEL. ref. 7005.00015 Colore standard cod. 56 / Standard colour cod. 56</p>
 <p>PVC : Altri colori disponibili su ordinazione / Other colour against specific order / (min. 3 pcs)</p>	<p>Actros Mp2</p> <p>TAPPETO FLOOR MAT</p> <p>COS.PEL. ref. 7005.00016 PVC Colore standard cod. 38 / Standard colour cod. 38</p> <p>COS.PEL. ref. 7005.00017 MOQUETTES / CARPETED Colore unico cod. 41 / One colour only cod. 41</p>
 <p>PVC : Altri colori disponibili su ordinazione / Other colour against specific order / (min. 3 pcs)</p>	<p>Actros Mp2 Mega Space</p> <p>TAPPETO FLOOR MAT</p> <p>COS.PEL. ref. 7005.00018 PVC Colore standard cod. 38 / Standard colour cod. 38</p> <p>COS.PEL. ref. 7005.00019 MOQUETTES / CARPETED Colore unico cod. 41 / One colour only cod. 41</p>
 <p>Altri colori disponibili su ordinazione / Other colour against specific order / (min. 3 pcs)</p>	<p>Actros 2014 Mp4</p> <p>FODERA SEDILE - LATO GUIDA POGGIATESTA INCORPORATO - PASSAGGIO CINTURA</p> <p>SEAT COVER - DRIVER'S SEAT BUILT-IN HEAD RESTRAINT - CUT OUT FOR SAFETY BELT</p> <p>COS.PEL. ref. 7005.00021 Colore standard cod. 56 / Standard colour cod. 56</p>

 <p>PVC : Altri colori disponibili su ordinazione / Other colour against specific order / (min. 3 pcs)</p>	<p>Actros Mp2</p> <p>COPRICOFANO PVC - TERMOSALDATO - CABINA LUNGA - CAMBIO AL VOLANTE</p> <p>DASH COVER HEAT-SEALED PVC ITEM FOR LONG CAB WITH STEERING WHEEL PADDLE SHIFTERS</p> <p>COS.PEL. ref. 7005.00020 PVC Colore standard cod. 38 / Standard colour cod. 38</p>
 <p>Altri colori disponibili su ordinazione / Other colour against specific order / (min. 3 pcs)</p>	<p>Actros 2014 Mp4</p> <p>FODERA SEDILE - LATO GUIDA POGGIATESTA INCORPORATO - PASSAGGIO CINTURA - BICOLORE</p> <p>SEAT COVER - DRIVER'S SEAT BUILT-IN HEAD RESTRAINT - CUT OUT FOR SAFETY BELT - 2 COLOURS</p> <p>COS.PEL. ref. 7005.00022 Colore standard cod. 55+59bis / Standard colour cod. 55+59bis</p>
 <p>Altri colori disponibili su ordinazione / Other colour against specific order / (min. 3 pcs)</p>	<p>Actros 2014 Mp4</p> <p>FODERA SEDILE - SERIE DUE POSTI CON CINTURA E POGGIATESTA INCORPORATO</p> <p>SEAT COVERS - TWO SEATS SERIES WITH SAFETY BELT AND BUILT-IN HEAD RESTRAINT</p> <p>COS.PEL. ref. 7005.00023 Colore standard cod. 56 / Standard colour cod. 56</p>
 <p>Altri colori disponibili su ordinazione / Other colour against specific order / (min. 3 pcs)</p>	<p>Actros 2014 Mp4</p> <p>FODERA SEDILE - SERIE DUE POSTI CON CINTURE E POGGIATESTA INCORPORATO - BICOLORE</p> <p>SEAT COVERS - TWO SEATS SERIES WITH SAFETY BELT AND BUILT-IN HEAD RESTRAINT - 2 COLOURS</p> <p>COS.PEL. ref. 7005.00024 Colore standard cod. 55+59bis / Standard colour cod. 55+59bis</p>
 <p>Altri colori disponibili su ordinazione / Other colour against specific order / (min. 3 pcs)</p>	<p>Actros 2014 Mp4</p> <p>FODERA SEDILE DUE POSTI POGGIATESTA INCORPORATI - SED. DX : SEDUTA RIBALTABILE</p> <p>SEAT COVERS - SERIES TWO SEATS BUILT-IN HEAD RESTRAINT - RECLINING SEAT ON THE RIGHT</p> <p>COS.PEL. ref. 7005.00025 Colore standard cod. 56 / Standard colour cod. 56</p>
 <p>Altri colori disponibili su ordinazione / Other colour against specific order / (min. 3 pcs)</p>	<p>Actros 2014 Mp4</p> <p>FODERA SEDILE - SERIE DUE POSTI POGGIATESTA INCORPORATO - SED. DX SEDUTA RIBALTABILE - BICOLORE</p> <p>SEAT COVERS - TWO SEATS SERIES BUILT-IN HEAD RESTRAINT - RECLINING SEAT ON THE RIGHT - 2 COLOURS</p> <p>COS.PEL. ref. 7005.00026 Colore standard cod. 55+59bis / Standard colour cod. 55+59bis</p>
 <p>PVC : Altri colori disponibili su ordinazione / Other colour against specific order / (min. 3 pcs)</p>	<p>Actros 2014 Mp4</p> <p>TAPPETO CABINA TUTTA PIANA FLOOR MAT PLAIN CAB</p> <p>COS.PEL. ref. 7005.00027 PVC Colore standard cod. 38 / Standard colour cod. 38</p> <p>COS.PEL. ref. 7005.00028 MOQUETTES / CARPETED Colore unico cod. 41 / One colour only cod. 41</p>

PARTI DI RICAMBIO ADATTABILI A : **COS.IVE**
 SPARE PARTS SUITABLE TO :

 <p>Altri colori disponibili su ordinazione / Other colour against specific order / (min. 3 pcs)</p>	<p>Stralis XP</p> <p>FODERA SEDILE - SERIE DUE POSTI POGGIATESTA INCORPORATI - BICOLORE</p> <p>SEAT COVERS - TWO SEATS SERIES WITH BUILT-IN HEAD RESTRAINTS - 2 COLOURS</p> <p>COS.PEL. ref. 7006.00169</p> <p>Colore standard cod. 55+55bis / Standard colour cod. 55+55bis</p>
 <p>Altri colori disponibili su ordinazione / Other colour against specific order / (min. 3 pcs)</p>	<p>Daily 2010</p> <p>FODERA SEDILE - LATO GUIDA CON PASSAGGIO POGGIATESTA</p> <p>SEAT COVER - DRIVER'S SEAT WITH CUT OUT FOR HEAD RESTRAINTS</p> <p>COS.PEL. ref. 7006.00104</p> <p>Colore standard cod. 56 / Standard colour cod. 56</p>
 <p>Altri colori disponibili su ordinazione / Other colour against specific order / (min. 3 pcs)</p>	<p>Daily 2010</p> <p>FODERA SEDILE - SERIE TRE POSTI SEDILE GUIDA CON PASSAGGIO POGGIATESTA E PANCHETTA - 2 COLORI</p> <p>SEAT COVERS - THREE SEATS SERIES DRIVER'S SEAT WITH CUT OUT FOR HEAD RESTRAINT AND BENCH SEAT - 2 COLOURS</p> <p>COS.PEL. ref. 7006.00105</p> <p>Colore standard cod. 56 / Standard colour cod. 56</p>
 <p>Altri colori disponibili su ordinazione / Other colour against specific order / (min. 3 pcs)</p>	<p>Daily 2010</p> <p>FODERA SEDILE - SERIE TRE POSTI SEDILE GUIDA CON PASSAGGIO POGGIATESTA E PANCHETTA CON PASSAGGIO CINTURA - 2 COLORI</p> <p>SEAT COVERS - THREE SEATS SERIES DRIVER'S SEAT WITH CUT OUT FOR HEAD REST. AND BENCH S. WITH CUT OUT FOR SEATBELT ANCHOR. - 2 COLOURS</p> <p>COS.PEL. ref. 7006.00106</p> <p>Colore standard cod. 56 / Standard colour cod. 56</p>
<p>AD ESAURIMENTO SCORTE UNTIL SELL-OUT</p>  <p>Colore unico / One colour only</p>	<p>190</p> <p>SEDUTA SEDILE PER SEDILE ISIGN COMPOSTA DA IMBOTTITURA + FODERA</p> <p>SEAT CUSHION FOR ISING SEAT FORMED FROM CUSHIONING + COVER</p> <p>COS.PEL. ref. 7006.10014</p> <p>Colore unico cod. 20 / One colour only cod. 20</p>
 <p>Altri colori disponibili su ordinazione / Other colour against specific order / (min. 3 pcs)</p>	<p>Daily 2010</p> <p>FODERA SEDILE - SERIE SEI+UNO POSTI SEDILE GUIDA CON PASSAGGIO POGGIATESTA E PANCHETTA 2 POSTI - PANCHETTA 4 POSTI</p> <p>SEAT COVERS - SIX+ONE SEATS SERIES DRIVER'S SEAT WITH CUT OUT FOR HEAD RESTRAINT AND 2-PLACE BENCH - 4-PLACE BENCH SEAT</p> <p>COS.PEL. ref. 7006.00107</p> <p>Colore standard cod. 56 / Standard colour cod. 56</p>
 <p>Colore unico / One colour only</p>	<p>190 / 190-115</p> <p>SEDUTA SEDILE PER SEDILE ISIGN COMPOSTA DA IMBOTTITURA + FODERA</p> <p>SEAT CUSHION FOR ISING SEAT FORMED FROM CUSHIONING + COVER</p> <p>COS.PEL. ref. 7006.10015</p> <p>Colore unico cod. 20 / One colour only cod. 20</p>
 <p>Altri colori disponibili su ordinazione / Other colour against specific order / (min. 3 pcs)</p>	<p>Daily 2010</p> <p>FODERA SEDILE - SERIE SEI+UNO POSTI SEDILE GUIDA CON PASSAGGIO POGGIATESTA E PANCHETTA 2 POSTI CON PASSAGGIO CINTURA - PANCHETTA 4 POSTI</p> <p>SEAT COVERS - SIX+ONE SEATS SERIES DRIVER'S SEAT WITH CUT OUT FOR HE. REST. AND 2 PL. BENCH S. WITH CUT OUT FOR SAF. BELT - 4 PL. BENCH</p> <p>COS.PEL. ref. 7006.00108</p> <p>Colore standard cod. 56 / Standard colour cod. 56</p>

 <p>Altri colori disponibili su ordinazione / Other colour against specific order / (min. 3 pcs)</p>	<p>Daily 2010 Combi</p> <p>FODERA SEDILE - SERIE UN POSTO SEDILE POSTERIORE SINGOLO</p> <p>SEAT COVERS - ONE SEAT SERIES SINGLE REAR SEAT</p> <p>COS.PEL. ref. 7006.00109</p> <p>Colore standard cod. 56 / Standard colour cod. 56</p>
 <p>Altri colori disponibili su ordinazione / Other colour against specific order / (min. 3 pcs)</p>	<p>Daily 2010 Combi</p> <p>FODERA SEDILE - SERIE TRE+TRE POSTI SEDILE GUIDA - PANCHETTA 2 POSTI CON CINTURA - 3 SEDILI SINGOLI CON CINTURA</p> <p>SEAT COVERS - THREE+THREE SEATS SERIES DRIVER'S SEAT - 2 PLACE BENCH SEAT WITH SAFETY BELT - 3 SINGLE SEAT WITH SAFETY BELT</p> <p>COS.PEL. ref. 7006.00110</p> <p>Colore standard cod. 56 / Standard colour cod. 56</p>
 <p>Altri colori disponibili su ordinazione / Other colour against specific order / (min. 3 pcs)</p>	<p>Daily 2010 Combi</p> <p>FODERA SEDILE - SERIE TRE+SEI POSTI SEDILE GUIDA - PANCHETTA 2 POSTI CON CINTURA E 6 SEDILI SINGOLI CON CINTURA</p> <p>SEAT COVERS - THREE+SIX SEATS SERIES DRIVER'S SEAT - 2 PLACE BENCH SEAT WITH SAFETY BELT AND 6 SINGLE SEAT WITH SAFETY BELT</p> <p>COS.PEL. ref. 7006.00111</p> <p>Colore standard cod. 56 / Standard colour cod. 56</p>
 <p>Colore unico / One colour only</p>	<p>Daily 2010</p> <p>SEDUTA SEDILE COMPOSTA DA IMBOTTITURA + FODERA</p> <p>SEAT CUSHION FORMED FROM CUSHIONING + COVER</p> <p>COS.PEL. ref. 7006.10022</p> <p>Daily 2010 Colore unico cod. 56bis / One colour only cod. 56bis</p> <p>COS.PEL. ref. 7006.10025</p> <p>Daily 2010 - versione economica / economic version Colore unico cod. 56bis / One colour only cod. 56bis</p>
 <p>Altri colori disponibili su ordinazione / Other colour against specific order / (min. 3 pcs)</p>	<p>Daily 2006</p> <p>FODERA SEDILE - LATO GUIDA SEDILE GUIDA CON PASSAGGIO POGGIATESTA</p> <p>SEAT COVER - DRIVER'S SEAT DRIVER'S SEAT WITH CUT OUT IN THE TISSUE FOR HEAD RESTRAINTS</p> <p>COS.PEL. ref. 7006.00091</p> <p>Colore standard cod. 51 / Standard colour cod. 51</p>
 <p>Altri colori disponibili su ordinazione / Other colour against specific order / (min. 3 pcs)</p>	<p>Daily 2006</p> <p>FODERA SEDILE - SERIE TRE POSTI SEDILE GUIDA PASSAGGIO POGGIATESTA E PANCHETTA</p> <p>SEAT COVERS - THREE SEATS SERIES DRIVER'S SEAT WITH CUT OUT FOR HEAD RESTRAINTS AND BENCH SEAT</p> <p>COS.PEL. ref. 7006.00092</p> <p>Colore standard cod. 51 / Standard colour cod. 51</p>
 <p>Altri colori disponibili su ordinazione / Other colour against specific order / (min. 3 pcs)</p>	<p>Eurocargo 98 Tector</p> <p>FODERA SEDILE - SERIE TRE POSTI SEDILE PNEUMATICO , PANCHETTA CON SCHIENALE DIVISO</p> <p>SEAT COVERS - THREE SEATS SERIES PNEUMATIC COVER SEAT - BENCH SEAT WITH SEPARATED BACKREST</p> <p>COS.PEL. ref. 7006.00000</p> <p>Colore standard cod. 14 / Standard colour cod. 14</p>
 <p>Altri colori disponibili su ordinazione / Other colour against specific order / (min. 3 pcs)</p>	<p>Daily 2006</p> <p>FODERA SEDILE - SERIE TRE POSTI SEDILE GUIDA CON PASSAGGIO POGGIATESTA - PANCHETTA CON PASSAGGIO CINTURA</p> <p>SEAT COVERS - THREE SEATS SERIES DRIVER'S SEAT WITH CUT OUT FOR HEAD RESTRAINT - BENCH SEAT WITH CUT OUT FOR SEAT BELT ANCHORAGE</p> <p>COS.PEL. ref. 7006.00093</p> <p>Colore standard cod. 51 / Standard colour cod. 51</p>









PARTI DI RICAMBIO ADATTABILI A : **COS.IVE**
 SPARE PARTS SUITABLE TO :

 <p>Altri colori disponibili su ordinazione / Other colour against specific order / (min. 3 pcs)</p>	<p>Eurocargo 98 Tector</p> <p>FODERA SEDILE - LATO GUIDA SEDILE GUIDA PNEUMATICO</p> <p>SEAT COVER - DRIVER'S SEAT PNEUMATIC DRIVER'S SEAT</p> <p>COS.PEL. ref. 7006.00001</p> <p>Colore standard cod. 14 / Standard colour cod. 14</p>
 <p>Altri colori disponibili su ordinazione / Other colour against specific order / (min. 3 pcs)</p>	<p>Eurotrakker 98 Seconda Serie</p> <p>FODERA SEDILE - SERIE DUE POSTI SEDILE GUIDA PNEUMATICO CON PASSAGGIO CINTURE E POGGIATESTA - SEDILE DX : SCHIENALE BASSO</p> <p>SEAT COVERS - TWO SEATS SERIES PNEUMATIC DRIVER'S SEAT WITH SAFETY BELTS CUT OUT AND HEAD RESTRAINT - LOW-BACK RH SEAT</p> <p>COS.PEL. ref. 7006.00039</p> <p>Colore standard cod. 12 / Standard colour cod. 12</p>
 <p>Altri colori disponibili su ordinazione / Other colour against specific order / (min. 3 pcs)</p>	<p>Daily 2006</p> <p>FODERA SEDILE - SERIE SEI+UNO POSTI SEDILE GUIDA CON PASSAGGIO POGGIATESTA E PANCHETTA 2 POSTI - PANCHETTA 4 POSTI</p> <p>SEAT COVERS - SIX+ONE SEATS SERIES DRIVER'S SEAT WITH CUT OUT FOR HEAD RESTRAINT AND 2-PLACE BENCH - 4-PLACE BENCH SEAT</p> <p>COS.PEL. ref. 7006.00094</p> <p>Colore standard cod. 51 / Standard colour cod. 51</p>
 <p>Altri colori disponibili su ordinazione / Other colour against specific order / (min. 3 pcs)</p>	<p>Eurocargo 98 Tector</p> <p>FODERA SEDILE - SERIE DUE POSTI SEDILE PNEUMATICO CON PASSAGGIO CINTURE</p> <p>SEAT COVERS - TWO SEATS SERIES PNEUMATIC COVER SEAT WITH OPENINGS FOR BUCKLE RECEIVERS</p> <p>COS.PEL. ref. 7006.00002</p> <p>Colore standard cod. 14 / Standard colour cod. 14</p>
 <p>Altri colori disponibili su ordinazione / Other colour against specific order / (min. 3 pcs)</p>	<p>Eurotrakker 98 Seconda Serie</p> <p>FODERA SEDILE - LATO GUIDA SEDILE GUIDA PNEUMATICO CON PASSAGGIO CINTURE E POGGIATESTA</p> <p>SEAT COVER - DRIVER'S SEAT PNEUMATIC DRIVER'S SEAT WITH SAFETY BELT CUT OUT AND HEAD RESTRAINT</p> <p>COS.PEL. ref. 7006.00040</p> <p>Colore standard cod. 12 / Standard colour cod. 12</p>
 <p>Altri colori disponibili su ordinazione / Other colour against specific order / (min. 3 pcs)</p>	<p>Daily 2006</p> <p>FODERA SEDILE SEI+UNO POSTI SEDILE GUIDA CON PASSAGGIO POGGIATESTA E PANCHETTA 2 POSTI CON PASS. CINTURA - PANCHETTA 4 POSTI</p> <p>SEAT COVERS - SERIES SIX+ONE SEATS DRIVER'S SEAT WITH CUT OUT FOR HEAD RESTRAINT 2 PLACE BENCH WITH CUT OUT FOR S. BELT - 4 PLACE BENCH</p> <p>COS.PEL. ref. 7006.00095</p> <p>Colore standard cod. 51 / Standard colour cod. 51</p>
 <p>Altri colori disponibili su ordinazione / Other colour against specific order / (min. 3 pcs)</p>	<p>Eurotrakker 98 Seconda Serie</p> <p>FODERA SEDILE - SERIE DUE POSTI SEDILE GUIDA PNEUMATICO CON PASSAGGIO CINTURE - SEDILE DX SCHIENALE BASSO - 2 POGGIATESTA</p> <p>SEAT COVERS - TWO SEATS SERIES PNEUMATIC DRIVER'S SEAT WITH SAFETY BELT CUT OUT - LOW-BACK RH SEAT - 2 HEAD RESTRAINTS</p> <p>COS.PEL. ref. 7006.00041</p> <p>Colore standard cod. 12 / Standard colour cod. 12</p>
 <p>Altri colori disponibili su ordinazione / Other colour against specific order / (min. 3 pcs)</p>	<p>Daily 2006 Combi</p> <p>FODERA SEDILE - SERIE QUATTRO POSTI PANCHETTA POSTERIORE 4 POSTI</p> <p>SEAT COVERS - FOUR SEATS SERIES 4-PLACE REAR BENCH SEAT</p> <p>COS.PEL. ref. 7006.00096</p> <p>Colore standard cod. 51 / Standard colour cod. 51</p>

 <p>PVC : Altri colori disponibili su ordinazione / Other colour against specific order / (min. 3 pcs)</p>	<p>Eurocargo</p> <p>COPRICOFANO PVC - TERMOSALDATO DASH COVER HEAT-SEALED PVC ITEM COS.PEL. ref. 7006.00003 PVC - CABINA CORTA / SHORT CAB Colore standard cod. 38 / Standard colour cod. 38 COS.PEL. ref. 7006.00004 PVC - CABINA LUNGA / LONG CAB Colore standard cod. 38 / Standard colour cod. 38</p>
 <p>PVC : Altri colori disponibili su ordinazione / Other colour against specific order / (min. 3 pcs)</p>	<p>Eurotrakker 98 Seconda Serie</p> <p>COPRICOFANO PVC - TERMOSALDATO - CABINA CORTA DASH COVER PVC - HEAT-SEALED FOR SHORT CAB COS.PEL. ref. 7006.00042 PVC Colore standard cod. 38 / Standard colour cod. 38</p>
 <p>Altri colori disponibili su ordinazione / Other colour against specific order / (min. 3 pcs)</p>	<p>Daily 2006 Combi</p> <p>FODERA SEDILE - SERIE TRE+TRE POSTI SEDILE GUIDA - PANCHETTA 2 POSTI CON CINTURA E 3 SEDILI SINGOLI CON CINTURA SEAT COVERS - THREE+THREE SEATS SERIES DRIVER'S SEAT 2 PLACE BENCH SEAT WITH SAFETY BELT 3 SINGLE SEAT WITH SAFETY BELT COS.PEL. ref. 7006.00097 Colore standard cod. 51 / Standard colour cod. 51</p>
 <p>PVC : Altri colori disponibili su ordinazione / Other colour against specific order / (min. 3 pcs)</p>	<p>Eurocargo</p> <p>TAPPETO FLOOR MAT COS.PEL. ref. 7006.00005 PVC Colore standard cod. 38 / Standard colour cod. 38 COS.PEL. ref. 7006.00006 MOQUETTES / CARPETED Colore unico cod. 41 / One colour only cod. 41</p>
 <p>PVC : Altri colori disponibili su ordinazione / Other colour against specific order / (min. 3 pcs)</p>	<p>Eurotrakker 98 Seconda Serie</p> <p>TAPPETO FLOOR MAT COS.PEL. ref. 7006.00043 PVC Colore standard cod. 38 / Standard colour cod. 38 COS.PEL. ref. 7006.00044 MOQUETTES / CARPETED Colore unico cod. 41 / One colour only cod. 41</p>
 <p>Altri colori disponibili su ordinazione / Other colour against specific order / (min. 3 pcs)</p>	<p>Daily 2006 Combi</p> <p>FODERA SEDILE - SERIE TRE+SEI POSTI SEDILE GUIDA - PANCHETTA 2 POSTI CON CINTURA E 6 SEDILI SINGOLI CON CINTURA SEAT COVERS - THREE+SIX SEATS SERIES DRIVER'S SEAT - 2 PLACE BENCH SEAT WITH SAFETY BELT AND 6 SINGLE SEATS WITH SAFETY BELTS COS.PEL. ref. 7006.00098 Colore standard cod. 51 / Standard colour cod. 51</p>
 <p>Altri colori disponibili su ordinazione / Other colour against specific order / (min. 3 pcs)</p>	<p>Daily 2006 Combi</p> <p>FODERA SEDILE - SERIE UN POSTO SEDILE POSTERIORE SINGOLO SEAT COVERS - ONE SEAT SERIES SINGLE REAR SEAT COS.PEL. ref. 7006.00099 Colore standard cod. 51 / Standard colour cod. 51</p>
 <p>Altri colori disponibili su ordinazione / Other colour against specific order / (min. 3 pcs)</p>	<p>Eurocargo 98 Seconda Serie</p> <p>FODERA SEDILE - SERIE DUE POSTI SEDILE CON SCHIENALE BASSO SEAT COVERS - TWO SEATS SERIES LOW-BACKED SEAT COS.PEL. ref. 7006.00007 Colore standard cod. 14 / Standard colour cod. 14</p>

PARTI DI RICAMBIO ADATTABILI A : **COS.IVE**
 SPARE PARTS SUITABLE TO :

 <p>PVC : Altri colori disponibili su ordinazione / Other colour against specific order / (min. 3 pcs)</p>	<p>Daily 2006/2010</p> <p>TAPPETO FLOOR MAT</p> <p>COS.PEL. ref. 7006.00100 PVC Colore standard cod. 38 / Standard colour cod. 38</p> <p>COS.PEL. ref. 7006.00101 MOQUETTES / CARPETED Colore unico cod. 41 / One colour only cod. 41</p>
 <p>PVC : Altri colori disponibili su ordinazione / Other colour against specific order / (min. 3 pcs)</p>	<p>Stralis Act.Day-Time / Euro 5</p> <p>COPRICOFANO PVC - CABINA LUNGA - (per favore specificare se cambio manuale o automatico)</p> <p>DASH COVER PVC - LONG CABIN - (please specify if shift is manual or automatic)</p> <p>COS.PEL. ref. 7006.00140 PVC - SENZA FRIGO / WITHOUT FRIDGE Colore standard cod. 38 / Standard colour cod. 38</p> <p>COS.PEL. ref. 7006.00141 PVC - CON FRIGO / WITH FRIDGE Colore standard cod. 38 / Standard colour cod. 38</p>
 <p>Altri colori disponibili su ordinazione / Other colour against specific order / (min. 3 pcs)</p>	<p>Eurocargo 98 Seconda Serie</p> <p>FODERA SEDILE - SERIE DUE POSTI SEDILE SX CON PASSAGGIO CINTURE - SEDILE DX CON SCHIENALE BASSO</p> <p>SEAT COVERS - TWO SEATS SERIES LH SIDE WITH CUT OUT FOR SEAT BELT ANCHORAGE - RH SIDE LOW-BACKED SEAT</p> <p>COS.PEL. ref. 7006.00008</p> <p>Colore standard cod. 14 / Standard colour cod. 14</p>
 <p>Altri colori disponibili su ordinazione / Other colour against specific order / (min. 3 pcs)</p>	<p>Eurocargo 98 Seconda Serie</p> <p>FODERA SEDILE - SERIE DUE POSTI SEDILE PNEUMATICO CON CINTURE E POGGIATESTA</p> <p>SEAT COVERS - TWO SEATS SERIES PNEUMATIC COVER SEAT WITH SAFETY BELTS AND HEAD RESTRAINT</p> <p>COS.PEL. ref. 7006.00009</p> <p>Colore standard cod. 14 / Standard colour cod. 14</p>
 <p>PVC : Altri colori disponibili su ordinazione / Other colour against specific order / (min. 3 pcs)</p>	<p>Daily 2006</p> <p>TAPPETO POSTERIORE FLOOR MAT REAR</p> <p>COS.PEL. ref. 7006.00102 PVC Colore standard cod. 38 / Standard colour cod. 38</p> <p>COS.PEL. ref. 7006.00103 MOQUETTES / CARPETED Colore unico cod. 41 / One colour only cod. 41</p>
 <p>PVC : Altri colori disponibili su ordinazione / Other colour against specific order / (min. 3 pcs)</p>	<p>Stralis Act.Day-Time / Euro 5</p> <p>COPRICOFANO PVC - CABINA CORTA - (per favore specificare se cambio manuale o automatico)</p> <p>DASH COVER PVC - SHORT CAB - (please specify if shift is manual or automatic)</p> <p>COS.PEL. ref. 7006.00142 PVC - SENZA FRIGO / WITHOUT FRIDGE Colore standard cod. 38 / Standard colour cod. 38</p>
 <p>Altri colori disponibili su ordinazione / Other colour against specific order / (min. 3 pcs)</p>	<p>Eurocargo 98 Seconda Serie</p> <p>FODERA SEDILE - SERIE TRE POSTI SEDILE SINISTRO - SCHIENALE BASSO E PANCHETTA</p> <p>SEAT COVERS - THREE SEATS SERIES LEFT SEAT - LOW-BACK SEAT AND BENCH SEAT</p> <p>COS.PEL. ref. 7006.00010</p> <p>Colore standard cod. 14 / Standard colour cod. 14</p>
 <p>PVC : Altri colori disponibili su ordinazione / Other colour against specific order / (min. 3 pcs)</p>	<p>Stralis Act.Day-Time / Euro 5 / Hi Street Road</p> <p>TAPPETO FLOOR MAT</p> <p>COS.PEL. ref. 7006.00144 PVC Colore standard cod. 38 / Standard colour cod. 38</p> <p>COS.PEL. ref. 7006.00145 MOQUETTES / CARPETED Colore unico cod. 41 / One colour only cod. 41</p>

 <p>Altri colori disponibili su ordinazione / Other colour against specific order / (min. 3 pcs)</p>	<p>Eurocargo 98 Seconda Serie</p> <p>FODERA SEDILE - SERIE TRE POSTI SEDILE SINISTRO PNEUMATICO E PANCHETTA</p> <p>SEAT COVERS - THREE SEATS SERIES PNEUMATIC SEAT ON THE LEFT AND BENCH SEAT</p> <p>COS.PEL. ref. 7006.00011</p> <p>Colore standard cod. 14 / Standard colour cod. 14</p>
 <p>Colore unico / One colour only</p>	<p>Daily 2006</p> <p>SEDUTA SEDILE COMPOSTA DA IMBOTTITURA + FODERA</p> <p>SEAT CUSHION FORMED FROM CUSHIONING + COVER</p> <p>COS.PEL. ref. 7006.10021</p> <p>Colore unico cod. 51 / One colour only cod. 51</p>
 <p>Altri colori disponibili su ordinazione / Other colour against specific order / (min. 3 pcs)</p>	<p>Eurocargo 98 Seconda Serie</p> <p>FODERA SEDILE - LATO GUIDA SEDILE GUIDA CON SCHIENALE BASSO</p> <p>SEAT COVER - DRIVER'S SEAT DRIVER'S SEAT WITH LOW-BACK SEAT</p> <p>COS.PEL. ref. 7006.00012</p> <p>Colore standard cod. 14 / Standard colour cod. 14</p>
 <p>Altri colori disponibili su ordinazione / Other colour against specific order / (min. 3 pcs)</p>	<p>Eurocargo 2015 Euro 6</p> <p>FODERA SEDILE - LATO GUIDA POGGIATESTA INCORPORATO</p> <p>SEAT COVER - DRIVER'S SEAT WITH BUILT-IN HEAD RESTRAINT</p> <p>COS.PEL. ref. 7006.00177</p> <p>Colore standard cod. 56 / Standard colour cod. 56</p>
 <p>Altri colori disponibili su ordinazione / Other colour against specific order / (min. 3 pcs)</p>	<p>Eurocargo 98 Seconda Serie</p> <p>FODERA SEDILE - LATO GUIDA SEDILE GUIDA PNEUMATICO</p> <p>SEAT COVER - DRIVER'S SEAT PNEUMATIC DRIVER'S SEAT</p> <p>COS.PEL. ref. 7006.00013</p> <p>Colore standard cod. 14 / Standard colour cod. 14</p>
 <p>Altri colori disponibili su ordinazione / Other colour against specific order / (min. 3 pcs)</p>	<p>Eurocargo 2015 Euro 6</p> <p>FODERA SEDILE - SERIE DUE POSTI POGGIATESTA INCORPORATI</p> <p>SEAT COVERS - TWO SEATS SERIES WITH BUILT-IN HEAD RESTRAINTS</p> <p>COS.PEL. ref. 7006.00178</p> <p>Colore standard cod. 56 / Standard colour cod. 56</p>
 <p>Altri colori disponibili su ordinazione / Other colour against specific order / (min. 3 pcs)</p>	<p>Eurocargo 2015 Euro 6</p> <p>FODERA SEDILE - SERIE TRE POSTI SEDILE GUIDA CON POGGIATESTA INCORPORATO PANCHETTA E SCHIENALE UNICO</p> <p>SEAT COVERS - THREE SEATS SERIES DRIVER'S SEAT WITH BUILT IN HEAD REST. AND BENCH</p> <p>COS.PEL. ref. 7006.00179</p> <p>Colore standard cod. 56 / Standard colour cod. 56</p>
 <p>Altri colori disponibili su ordinazione / Other colour against specific order / (min. 3 pcs)</p>	<p>Eurocargo 2015 Euro 6</p> <p>FODERA SEDILE - SERIE TRE POSTI SEDILE GUIDA CON POGGIATESTA INCORPORATO PANCHETTA E SCHIENALI DIVISI</p> <p>SEAT COVERS - THREE SEATS SERIES DRIVER'S SEAT WITH BUILT IN HEAD REST. AND BENCH</p> <p>COS.PEL. ref. 7006.00180</p> <p>Colore standard cod. 56 / Standard colour cod. 56</p>

PARTI DI RICAMBIO ADATTABILI A : **COS.IVE**
 SPARE PARTS SUITABLE TO :

 <p>Colore unico / One colour only</p>	<p>Eurocargo 98</p> <p>SEDUTA SEDILE COMPOSTA DA IMBOTTITURA + FODERA SEAT CUSHION FORMED FROM CUSHIONING + COVER COS.PEL. ref. 7006.10001 SEDILE PNEUMATICO / PNEUMATIC SEAT Colore unico cod. 14 / One colour only cod. 14</p> <p>COS.PEL. ref. 7006.10002 SEDILE FISSO / FIXED SEAT Colore unico cod. 14 / One colour only cod. 14</p>
 <p>Colore unico / One colour only</p>	<p>Eurocargo 2008</p> <p>SEDUTA SEDILE COMPOSTA DA IMBOTTITURA + FODERA BICOLORE SEAT CUSHION FORMED FROM CUSHIONING + COVER 2 COLOURS COS.PEL. ref. 7006.10005 BICOLORE / 2 COLOURS Colore unico cod. 55+55bis / One colour only cod. 55+55bis</p>
 <p>PVC : Altri colori disponibili su ordinazione / Other colour against specific order / (min. 3 pcs)</p>	<p>Eurocargo 2015 Euro 6</p> <p>COPRICOFANO PVC - CABINA CORTA DASH COVER PVC - SHORT CABIN COS.PEL. ref. 7006.00181 PVC Colore standard cod. 38 / Standard colour cod. 38</p> <p>COS.PEL. ref. 7006.00182 PVC - CAMBIO AL VOLANTE / STEERING WHEEL PADDLE SHIFTER Colore standard cod. 38 / Standard colour cod. 38</p>
 <p>Altri colori disponibili su ordinazione / Other colour against specific order / (min. 3 pcs)</p>	<p>Eurocargo 2008</p> <p>FODERA SEDILE - L. GUIDA POGGIATESTA INCORPORATO SEAT COVER - D. SEAT WITH BUILT-IN HEAD RESTRAINTS COS.PEL. ref. 7006.00020 COLORE UNITO / PLAIN COLOUR Colore standard cod. 56 / Standard colour cod. 56</p> <p>COS.PEL. ref. 7006.00021 2 COLORI / 2 COLOURS Colore standard cod. 55+55bis / Standard colour cod. 55+55bis</p>
 <p>Colore unico / One colour only</p>	<p>Eurocargo 1a Serie</p> <p>SEDUTA SEDILE COMPOSTA DA IMBOTTITURA + FODERA SEAT CUSHION FORMED FROM CUSHIONING + COVER COS.PEL. ref. 7006.10003 SEDILE PNEUMATICO / PNEUMATIC SEAT Colore unico cod. 15 / One colour only cod. 15</p> <p>COS.PEL. ref. 7006.10004 SEDILE FISSO / FIXED SEAT Colore unico cod. 15 / One colour only cod. 15</p>
 <p>PVC : Altri colori disponibili su ordinazione / Other colour against specific order / (min. 3 pcs)</p>	<p>Eurocargo 2015 Euro 6</p> <p>COPRICOFANO PVC - CABINA LUNGA DASH COVER PVC - LONG CABIN COS.PEL. ref. 7006.00183 PVC Colore standard cod. 38 / Standard colour cod. 38</p> <p>COS.PEL. ref. 7006.00184 PVC - CAMBIO AL VOLANTE / STEERING WHEEL PADDLE SHIFTER Colore standard cod. 38 / Standard colour cod. 38</p>
 <p>Altri colori disponibili su ordinazione / Other colour against specific order / (min. 3 pcs)</p>	<p>Eurocargo 2008</p> <p>FODERA SEDILE - DUE POSTI POGGIATESTA INCORPORATI SEAT COVERS - TWO SEATS WITH BUILT-IN HEAD RESTRAINTS COS.PEL. ref. 7006.00022 COLORE UNITO / PLAIN COLOUR Colore standard cod. 56 / Standard colour cod. 56</p> <p>COS.PEL. ref. 7006.00023 2 COLORI / 2 COLOURS Colore standard cod. 55+55bis / Standard colour cod. 55+55bis</p>
 <p>Altri colori disponibili su ordinazione / Other colour against specific order / (min. 3 pcs)</p>	<p>Eurocargo 2015 Euro 6</p> <p>TAPPETO PVC FLOOR MAT PVC COS.PEL. ref. 7006.00185 PVC</p>

 <p>Altri colori disponibili su ordinazione / Other colour against specific order / (min. 3 pcs)</p>	<p>Eurocargo 2008</p> <p>FODERA SEDILE - L. GUIDA POGGIATESTA INCORPORATO SEAT COVER - D. SEAT WITH BUILT-IN HEAD RESTRAINTS COS.PEL. ref. 7006.00020 COLORE UNITO / PLAIN COLOUR Colore standard cod. 56 / Standard colour cod. 56 COS.PEL. ref. 7006.00021 2 COLORI / 2 COLOURS Colore standard cod. 55+55bis / Standard colour cod. 55+55bis</p>
 <p>Altri colori disponibili su ordinazione / Other colour against specific order / (min. 3 pcs)</p>	<p>Eurocargo 2008</p> <p>FODERA SEDILE - TRE POSTI SEDILE GUIDA POGGIATESTA INCORPORATO - PANCHETTA SCHIENALE DIVISI SEAT COVERS - THREE SEATS DRIVER'S SEAT WITH BUILT-IN HEAD RESTRAINT - BENCH SEAT AND SEPARATED BACKRESTS COS.PEL. ref. 7006.00024 COLORE UNITO / PLAIN COLOUR Colore standard cod. 56 / Standard colour cod. 56 COS.PEL. ref. 7006.00025 2 COLORI / 2 COLOURS Colore standard cod. 55+55bis / Standard colour cod. 55+55bis</p>
 <p>GOMMA : Altri colori disponibili su ordinazione / Other colour against specific order / (min. 3 pcs)</p>	<p>Eurocargo 2015 Euro 6</p> <p>TAPPETO GOMMA MILLERIGHE FLOOR MAT RUBBER COS.PEL. ref. 7006.00186 GOMMA/RUBBER</p>
 <p>Altri colori disponibili su ordinazione / Other colour against specific order / (min. 3 pcs)</p>	<p>Eurocargo 2015 Euro 6</p> <p>TAPPETO MOQUETTES FLOOR MAT CARPETED COS.PEL. ref. 7006.00187 MOQUETTES / CARPETED</p>
 <p>Altri colori disponibili su ordinazione / Other colour against specific order / (min. 3 pcs)</p>	<p>Eurocargo 2008</p> <p>FODERA SEDILE - DUE POSTI POGGIATESTA INCORPORATI SEAT COVERS - TWO SEATS WITH BUILT-IN HEAD RESTRAINTS COS.PEL. ref. 7006.00022 COLORE UNITO / PLAIN COLOUR Colore standard cod. 56 / Standard colour cod. 56 COS.PEL. ref. 7006.00023 2 COLORI / 2 COLOURS Colore standard cod. 55+55bis / Standard colour cod. 55+55bis</p>
 <p>PVC : Altri colori disponibili su ordinazione / Other colour against specific order / (min. 3 pcs)</p>	<p>Eurocargo 2008</p> <p>COPRICOFANO PVC - CABINA CORTA DASH COVER PVC - SHORT CAB COS.PEL. ref. 7006.00026 PVC Colore standard cod. 38 / Standard colour cod. 38 COS.PEL. ref. 7006.00027 PVC - CAMBIO AL VOLANTE / WITH STEERING WHEEL PADDLE SHIFTERS Colore standard cod. 38 / Standard colour cod. 38</p>
 <p>Altri colori disponibili su ordinazione / Other colour against specific order / (min. 3 pcs)</p>	<p>Eurocargo 2008</p> <p>FODERA SEDILE - TRE POSTI SEDILE GUIDA POGGIATESTA INCORPORATO - PANCHETTA SCHIENALE DIVISI SEAT COVERS - THREE SEATS DRIVER'S SEAT WITH BUILT-IN HEAD RESTRAINT - BENCH SEAT AND SEPARATED BACKRESTS COS.PEL. ref. 7006.00024 COLORE UNITO / PLAIN COLOUR Colore standard cod. 56 / Standard colour cod. 56 COS.PEL. ref. 7006.00025 2 COLORI / 2 COLOURS Colore standard cod. 55+55bis / Standard colour cod. 55+55bis</p>
 <p>PVC : Altri colori disponibili su ordinazione / Other colour against specific order / (min. 3 pcs)</p>	<p>Eurocargo 2008</p> <p>COPRICOFANO PVC - CABINA LUNGA DASH COVER PVC - LONG CABIN COS.PEL. ref. 7006.00028 PVC Colore standard cod. 38 / Standard colour cod. 38 COS.PEL. ref. 7006.00029 PVC - CAMBIO AL VOLANTE / WITH STEERING WHEEL PADDLE SHIFTERS Colore standard cod. 38 / Standard colour cod. 38</p>

PARTI DI RICAMBIO ADATTABILI A : **COS.IVE**
 SPARE PARTS SUITABLE TO :

 <p>PVC : Altri colori disponibili su ordinazione / Other colour against specific order / (min. 3 pcs)</p>	<p>Eurocargo 2008</p> <p>COPRICOFANO PVC - CABINA CORTA DASH COVER PVC - SHORT CAB COS.PEL. ref. 7006.00026 PVC Colore standard cod. 38 / Standard colour cod. 38 COS.PEL. ref. 7006.00027 PVC - CAMBIO AL VOLANTE / WITH STEERING WHEEL PADDLE SHIFTERS Colore standard cod. 38 / Standard colour cod. 38</p>
 <p>PVC : Altri colori disponibili su ordinazione / Other colour against specific order / (min. 3 pcs)</p>	<p>Eurocargo 2008</p> <p>TAPPETO FLOOR MAT COS.PEL. ref. 7006.00030 PVC Colore standard cod. 38 / Standard colour cod. 38 COS.PEL. ref. 7006.00031 MOQUETTES / CARPETED Colore unico cod. 41 / One colour only cod. 41</p>
 <p>Altri colori disponibili su ordinazione / Other colour against specific order / (min. 3 pcs)</p>	<p>New Daily 2000</p> <p>FODERA SEDILE - LATO GUIDA SEDILE GUIDA CON PASSAGGIO POGGIATESTA SEAT COVER - DRIVER'S SEAT DRIVER'S SEAT WITH CUT OUT FOR HEAD RESTRAINT COS.PEL. ref. 7006.00064 Colore standard cod. 17 / Standard colour cod. 17</p>
 <p>Altri colori disponibili su ordinazione / Other colour against specific order / (min. 3 pcs)</p>	<p>New Daily 2000</p> <p>FODERA SEDILE - LATO GUIDA CON PASSAGGIO POGGIATESTA E PASSAGGIO BRACCIOLE SEAT COVER - DRIVER'S SEAT DRIVER'S SEAT WITH CUT OUT IN THE TISSUE FOR HEAD RESTRAINT AND CUT OUT FOR ARMRESTS COS.PEL. ref. 7006.00065 Colore standard cod. 17 / Standard colour cod. 17</p>
 <p>PVC : Altri colori disponibili su ordinazione / Other colour against specific order / (min. 3 pcs)</p>	<p>Eurocargo 2008</p> <p>COPRICOFANO PVC - CABINA LUNGA DASH COVER PVC - LONG CABIN COS.PEL. ref. 7006.00028 PVC Colore standard cod. 38 / Standard colour cod. 38 COS.PEL. ref. 7006.00029 PVC - CAMBIO AL VOLANTE / WITH STEERING WHEEL PADDLE SHIFTERS Colore standard cod. 38 / Standard colour cod. 38</p>
 <p>Altri colori disponibili su ordinazione / Other colour against specific order / (min. 3 pcs)</p>	<p>New Daily 2000</p> <p>FODERA SEDILE - SERIE TRE POSTI SEDILE GUIDA CON PASSAGGIO POGGIATESTA E PANCHETTA SEAT COVERS - THREE SEATS SERIES DRIVER'S SEAT WITH CUT OUT FOR HEAD RESTRAINT AND BENCH SEAT COS.PEL. ref. 7006.00066 Colore standard cod. 17 / Standard colour cod. 17</p>
 <p>Altri colori disponibili su ordinazione / Other colour against specific order / (min. 3 pcs)</p>	<p>New Daily 2000</p> <p>FODERA SEDILE - SERIE TRE POSTI SEDILE GUIDA CON PASSAGGIO POGGIATESTA E PANCHETTA CON PASSAGGIO CINTURA SEAT COVERS - THREE SEATS SERIES DRIVER'S SEAT WITH CUT OUT FOR HEAD RESTRAINT AND BENCH SEAT WITH CUT OUT FOR SAFETY BELT ANCHORAGE COS.PEL. ref. 7006.00067 Colore standard cod. 17 / Standard colour cod. 17</p>
 <p>PVC : Altri colori disponibili su ordinazione / Other colour against specific order / (min. 3 pcs)</p>	<p>Eurocargo 2008</p> <p>TAPPETO FLOOR MAT COS.PEL. ref. 7006.00030 PVC Colore standard cod. 38 / Standard colour cod. 38 COS.PEL. ref. 7006.00031 MOQUETTES / CARPETED Colore unico cod. 41 / One colour only cod. 41</p>

 <p>Altri colori disponibili su ordinazione / Other colour against specific order / (min. 3 pcs)</p>	<p>New Daily 2000</p> <p>FODERA SEDILE - SERIE SEI+UNO POSTI SEDILE GUIDA CON PASSAGGIO POGGIATESTA E PANCHETTA 2 POSTI - PANCHETTA 4 POSTI</p> <p>SEAT COVERS - SIX+ONE SEATS SERIES DRIVER'S SEAT WITH CUT OUT FOR HEAD RESTRAINT AND 2-PLACE BENCH SEAT - 4-PLACE BENCH SEAT</p> <p>COS.PEL. ref. 7006.00068</p> <p>Colore standard cod. 17 / Standard colour cod. 17</p>
 <p>Altri colori disponibili su ordinazione / Other colour against specific order / (min. 3 pcs)</p>	<p>Daily 2014</p> <p>FODERA SEDILE - LATO GUIDA CON BRACCIOLI</p> <p>SEAT COVER - DRIVER'S SEAT WITH ARMRESTS</p> <p>COS.PEL. ref. 7006.00112</p> <p>Colore standard cod. 56 / Standard colour cod. 56</p>
 <p>Altri colori disponibili su ordinazione / Other colour against specific order / (min. 3 pcs)</p>	<p>New Daily 2000</p> <p>FODERA SEDILE - SERIE QUATTRO POSTI PANCHETTA POSTERIORE 4 POSTI</p> <p>SEAT COVERS - SERIES FOUR SEATS 4-PLACE REAR BENCH SEAT</p> <p>COS.PEL. ref. 7006.00069</p> <p>Colore standard cod. 17 / Standard colour cod. 17</p>
 <p>Altri colori disponibili su ordinazione / Other colour against specific order / (min. 3 pcs)</p>	<p>Daily 2014</p> <p>FODERA SEDILE - SERIE TRE POSTI SED. GUIDA PASS. BRACCIOLI - PANCHETTA 2 SED. SINGOLI RIBALTABILI SENZA PORTAOGG. PASS CINTURA LATE.</p> <p>SEAT COVERS - THREE SEATS SERIES DR. SEAT WITH CUT OUT FOR ARMRESTS - 2 PL. SINGLE BENCH W/O GLOVE COMPART. AND SIDE SAF. BELT CUT OUT</p> <p>COS.PEL. ref. 7006.00113</p> <p>Colore standard cod. 56 / Standard colour cod. 56</p>
 <p>Altri colori disponibili su ordinazione / Other colour against specific order / (min. 3 pcs)</p>	<p>New Daily Combi</p> <p>FODERA SEDILE - SERIE TRE+TRE POSTI SEDILE GUIDA PANCHETTA 2 POSTI CON CINTURA E 3 SEDILI SINGOLI CON CINTURA</p> <p>SEAT COVERS - THREE+THREE SEATS SERIES DRIVER'S SEAT 2 PLACE BENCH SEAT WITH SAFETY BELT AND 3 SINGLE SEAT WITH SAFETY BELTS</p> <p>COS.PEL. ref. 7006.00070</p> <p>Colore standard cod. 17 / Standard colour cod. 17</p>
 <p>Altri colori disponibili su ordinazione / Other colour against specific order / (min. 3 pcs)</p>	<p>Daily 2014</p> <p>FODERA SEDILE - SERIE TRE POSTI SED. GUIDA PASSAGGIO BRACCIOLI - PANCH. 2 SED. SING. RIBALTAB. CON CERN. PORTAOGGETTI - PASS. CINT. LAT.</p> <p>SEAT COVERS - THREE SEATS SERIES DR' SEAT WITH CUT OUT ARMREST - 2 PL. SING. BENCH S. WITH ZIP-FASTENER FOR GLO. COMP. AND C.O. FOR SAF. B.</p> <p>COS.PEL. ref. 7006.00114</p> <p>Colore standard cod. 56 / Standard colour cod. 56</p>
 <p>Altri colori disponibili su ordinazione / Other colour against specific order / (min. 3 pcs)</p>	<p>Daily 90</p> <p>FODERA SEDILE - LATO GUIDA</p> <p>SEAT COVER - DRIVER'S SEAT</p> <p>COS.PEL. ref. 7006.00053</p> <p>Colore standard cod. 20 / Standard colour cod. 20</p>
 <p>Altri colori disponibili su ordinazione / Other colour against specific order / (min. 3 pcs)</p>	<p>New Daily Combi</p> <p>FODERA SEDILE - SERIE TRE+SEI POSTI SEDILE GUIDA PANCHETTA 2 POSTI CON CINTURA E 6 SEDILI SINGOLI CON CINTURA</p> <p>SEAT COVERS - THREE+SIX SEATS SERIES DRIVER'S SEAT 2 PLACE BENCH SEAT WITH SAFETY BELT AND 6 SINGLE SEAT WITH SAFETY BELTS</p> <p>COS.PEL. ref. 7006.00071</p> <p>Colore standard cod. 17 / Standard colour cod. 17</p>

PARTI DI RICAMBIO ADATTABILI A : **COS.IVE**
SPARE PARTS SUITABLE TO :

 <p>Altri colori disponibili su ordinazione / Other colour against specific order / (min. 3 pcs)</p>	<p>Daily 2014</p> <p>FODERA SEDILE - SERIE SEI+UNO POSTI SEDILE GUIDA PASSAGGIO BRACCIOLO - PANCHETTA 2 POSTI SING. PASS. CINTURA - PANCH. 4 POSTI POSTERIORE</p> <p>SEAT COVERS - SIX+ONE SEATS SERIES DR.SEAT WITH C.O. FOR ARMREST. - 2 PL.SING.BENCH S.WITH C.O.FOR SAFETY BELT - 4 PLACE REAR BENCH SE.</p> <p>COS.PEL. ref. 7006.00115</p> <p>Colore standard cod. 56 / Standard colour cod. 56</p>
 <p>Altri colori disponibili su ordinazione / Other colour against specific order / (min. 3 pcs)</p>	<p>Daily 90</p> <p>FODERA SEDILE - SERIE TRE POSTI SENZA POGGIATESTA</p> <p>SEAT COVERS - THREE SEATS SERIES WITHOUT HEAD RESTRAINTS</p> <p>COS.PEL. ref. 7006.00054</p> <p>Colore standard cod. 20 / Standard colour cod. 20</p>
 <p>Altri colori disponibili su ordinazione / Other colour against specific order / (min. 3 pcs)</p>	<p>New Daily Combi</p> <p>FODERA SEDILE - SERIE UN POSTO SEDILE POSTERIORE SINGOLO</p> <p>SEAT COVERS - ONE SEAT SERIES SINGLE REAR SEAT</p> <p>COS.PEL. ref. 7006.00072</p> <p>Colore standard cod. 17 / Standard colour cod. 17</p>
 <p>PVC : Altri colori disponibili su ordinazione / Other colour against specific order / (min. 3 pcs)</p>	<p>Daily 2014</p> <p>TAPPETO FLOOR MAT</p> <p>COS.PEL. ref. 7006.00116 PVC Colore standard cod. 38 / Standard colour cod. 38</p> <p>COS.PEL. ref. 7006.00117 MOQUETTES / CARPETED Colore unico cod. 41 / One colour only cod. 41</p>
 <p>Altri colori disponibili su ordinazione / Other colour against specific order / (min. 3 pcs)</p>	<p>Daily 94</p> <p>FODERA SEDILE - SERIE TRE POSTI CON POGGIATESTA</p> <p>SEAT COVERS - THREE SEATS SERIES WITH HEAD RESTRAINTS</p> <p>COS.PEL. ref. 7006.00055</p> <p>Colore standard cod. 19 / Standard colour cod. 19</p>
 <p>PVC : Altri colori disponibili su ordinazione / Other colour against specific order / (min. 3 pcs)</p>	<p>New Daily 2000/2002</p> <p>TAPPETO FLOOR MAT</p> <p>COS.PEL. ref. 7006.00073 PVC Colore standard cod. 38 / Standard colour cod. 38</p> <p>COS.PEL. ref. 7006.00074 MOQUETTES / CARPETED Colore unico cod. 41 / One colour only cod. 41</p>
 <p>Altri colori disponibili su ordinazione / Other colour against specific order / (min. 3 pcs)</p>	<p>Eurocargo 2003 Restailing</p> <p>FODERA SEDILE - LATO GUIDA SEDILE GUIDA PNEUMATICO</p> <p>SEAT COVER - DRIVER'S SEAT PNEUMATIC DRIVER'S SEAT</p> <p>COS.PEL. ref. 7006.00014</p> <p>Colore standard cod. 47 / Standard colour cod. 47</p>
 <p>Altri colori disponibili su ordinazione / Other colour against specific order / (min. 3 pcs)</p>	<p>Daily 94</p> <p>FODERA SEDILE - SERIE TRE POSTI CON PASSAGGIO POGGIATESTA</p> <p>SEAT COVERS - THREE SEATS SERIES WITH CUT OUT IN THE TISSUE FOR HEAD RESTRAINTS</p> <p>COS.PEL. ref. 7006.00056</p> <p>Colore standard cod. 19 / Standard colour cod. 19</p>

 <p>Altri colori disponibili su ordinazione / Other colour against specific order / (min. 3 pcs)</p>	<p>Eurocargo 2003 Restyling</p> <p>FODERA SEDILE - LATO GUIDA SEDILE GUIDA CON SCHIENALE BASSO</p> <p>SEAT COVER - DRIVER'S SEAT DRIVER'S LOW-BACK SEAT</p> <p>COS.PEL. ref. 7006.00015</p> <p>Colore standard cod. 47 / Standard colour cod. 47</p>
 <p>Altri colori disponibili su ordinazione / Other colour against specific order / (min. 3 pcs)</p>	<p>New Daily 94</p> <p>FODERA SEDILE - LATO GUIDA</p> <p>SEAT COVER - DRIVER'S SEAT</p> <p>COS.PEL. ref. 7006.00057</p> <p>Colore standard cod. 19 / Standard colour cod. 19</p>
 <p>PVC : Altri colori disponibili su ordinazione / Other colour against specific order / (min. 3 pcs)</p>	<p>New Daily 2000/2002 Combi</p> <p>TAPPETO POSTERIORE - PRIMA FILA FLOOR MAT REAR - FIRST ROW</p> <p>COS.PEL. ref. 7006.00077 PVC Colore standard cod. 38 / Standard colour cod. 38</p> <p>COS.PEL. ref. 7006.00078 MOQUETTES / CARPETED Colore unico cod. 41 / One colour only cod. 41</p>
 <p>Altri colori disponibili su ordinazione / Other colour against specific order / (min. 3 pcs)</p>	<p>Eurocargo 2003 Restyling</p> <p>FODERA SEDILE - LATO GUIDA SEDILE GUIDA CON CINTURE</p> <p>SEAT COVER - DRIVER'S SEAT DRIVER'S SEAT WITH SAFETY BELT</p> <p>COS.PEL. ref. 7006.00016</p> <p>Colore standard cod. 47 / Standard colour cod. 47</p>
 <p>Altri colori disponibili su ordinazione / Other colour against specific order / (min. 3 pcs)</p>	<p>Daily 94</p> <p>FODERA SEDILE - SERIE SEI+UNO POSTI CON PASSAGGIO POGGIATESTA</p> <p>SEAT COVERS - SIX+ONE SEATS SERIES WITH CUT OUT IN THE TISSUE FOR HEAD RESTRAINTS</p> <p>COS.PEL. ref. 7006.00058</p> <p>Colore standard cod. 19 / Standard colour cod. 19</p>
 <p>Altri colori disponibili su ordinazione / Other colour against specific order / (min. 3 pcs)</p>	<p>Eurocargo 2003 Restyling</p> <p>FODERA SEDILE - SERIE DUE POSTI SEDILE PNEUMATICO CON CINTURE</p> <p>SEAT COVERS - TWO SEATS SERIES PNEUMATIC SEAT WITH SAFETY BELTS</p> <p>COS.PEL. ref. 7006.00017</p> <p>Colore standard cod. 47 / Standard colour cod. 47</p>
 <p>Altri colori disponibili su ordinazione / Other colour against specific order / (min. 3 pcs)</p>	<p>New Daily 96</p> <p>FODERA SEDILE - LATO GUIDA CON PASSAGGIO POGGIATESTA</p> <p>SEAT COVER - DRIVER'S SEAT WITH CUT OUT FOR HEAD RESTRAINT</p> <p>COS.PEL. ref. 7006.00059</p> <p>Colore standard cod. 18 / Standard colour cod. 18</p>
 <p>Altri colori disponibili su ordinazione / Other colour against specific order / (min. 3 pcs)</p>	<p>Eurocargo 2003 Restyling</p> <p>FODERA SEDILE - SERIE TRE POSTI SEDILE GUIDA PNEUMATICO E PANCHETTA SCHIENALI DIVISI</p> <p>SEAT COVERS - THREE SEATS SERIES PNEUMATIC DRIVER'S SEAT AND BENCH SEAT SEPARATED BACKRESTS</p> <p>COS.PEL. ref. 7006.00018</p> <p>Colore standard cod. 47 / Standard colour cod. 47</p>

PARTI DI RICAMBIO ADATTABILI A : **COS.IVE**
 SPARE PARTS SUITABLE TO :

 <p>Altri colori disponibili su ordinazione / Other colour against specific order / (min. 3 pcs)</p>	<p>New Daily 96</p> <p>FODERA SEDILE - SERIE TRE POSTI CON PASSAGGIO POGGIATESTA</p> <p>SEAT COVERS - THREE SEATS SERIES WITH CUT OUT IN THE TISSUE FOR HEAD RESTRAINTS</p> <p>COS.PEL. ref. 7006.00060</p> <p>Colore standard cod. 18 / Standard colour cod. 18</p>
 <p>PVC : Altri colori disponibili su ordinazione / Other colour against specific order / (min. 3 pcs)</p>	<p>New Daily 2000/2002 Combi</p> <p>TAPPETO POSTERIORE - SECONDA FILA FLOOR MAT REAR - SECOND ROW</p> <p>COS.PEL. ref. 7006.00079 PVC Colore standard cod. 38 / Standard colour cod. 38</p> <p>COS.PEL. ref. 7006.00080 MOQUETTES / CARPETED Colore unico cod. 41 / One colour only cod. 41</p>
 <p>Altri colori disponibili su ordinazione / Other colour against specific order / (min. 3 pcs)</p>	<p>Eurocargo 2003 Restailing</p> <p>FODERA SEDILE - SERIE TRE POSTI SEDILE GUIDA SCHIENALE BASSO E PANCHETTA SCHIENALI DIVISI</p> <p>SEAT COVERS - THREE SEATS SERIES LOW-BACK DRIVER'S SEAT AND BENCH SEAT SEPARATED BACKRESTS</p> <p>COS.PEL. ref. 7006.00019</p> <p>Colore standard cod. 47 / Standard colour cod. 47</p>
 <p>Altri colori disponibili su ordinazione / Other colour against specific order / (min. 3 pcs)</p>	<p>New Daily 96</p> <p>FODERA SEDILE - SERIE SEI+UNO POSTI</p> <p>SEAT COVERS - SIX+ONE SEATS SERIES</p> <p>COS.PEL. ref. 7006.00061</p> <p>Colore standard cod. 18 / Standard colour cod. 18</p>
 <p>Altri colori disponibili su ordinazione / Other colour against specific order / (min. 3 pcs)</p>	<p>New Daily 2002</p> <p>FODERA SEDILE - LATO GUIDA CON PASSAGGIO POGGIATESTA</p> <p>SEAT COVER - DRIVER'S SEAT WITH CUT OUT FOR HEAD RESTRAINTS</p> <p>COS.PEL. ref. 7006.00081</p> <p>Colore standard cod. 42 / Standard colour cod. 42</p>
 <p>PVC : Altri colori disponibili su ordinazione / Other colour against specific order / (min. 3 pcs)</p>	<p>New Daily 96</p> <p>TAPPETO FLOOR MAT</p> <p>COS.PEL. ref. 7006.00062 PVC Colore standard cod. 38 / Standard colour cod. 38</p> <p>COS.PEL. ref. 7006.00063 MOQUETTES / CARPETED Colore unico cod. 41 / One colour only cod. 41</p>
 <p>Altri colori disponibili su ordinazione / Other colour against specific order / (min. 3 pcs)</p>	<p>New Daily 2002</p> <p>FODERA SEDILE - LATO GUIDA CON PASSAGGIO POGGIATESTA E PASSAGGIO BRACCIOLI</p> <p>SEAT COVER - DRIVER'S SEAT WITH CUT OUT IN THE TISSUE FOR HEAD RESTRAINT AND CUT OUT FOR ARMRESTS</p> <p>COS.PEL. ref. 7006.00082</p> <p>Colore standard cod. 42 / Standard colour cod. 42</p>
 <p>Colore unico / One colour only</p>	<p>Eurocargo 2003</p> <p>SEDUTA SEDILE PER SEDILE PNEUMATICO COMPOSTA DA: IMBOTTITURA + FODERA</p> <p>SEAT CUSHION WITH COVER FOR PNEUMATIC SEAT FORMED FROM CUSHIONING + COVER</p> <p>COS.PEL. ref. 7006.10000</p> <p>Colore unico cod. 47 / One colour only cod. 47</p>

 <p>Altri colori disponibili su ordinazione / Other colour against specific order / (min. 3 pcs)</p>	<p>New Daily 2002</p> <p>FODERA SEDILE - SERIE TRE POSTI SEDILE GUIDA PASSAGGIO POGGIATESTA E PANCHETTA</p> <p>SEAT COVERS - THREE SEATS SERIES DRIVER'S SEAT WITH CUT OUT FOR HEAD RESTRAINTS AND BENCH SEAT</p> <p>COS.PEL. ref. 7006.00083</p> <p>Colore standard cod. 42 / Standard colour cod. 42</p>
 <p>Altri colori disponibili su ordinazione / Other colour against specific order / (min. 3 pcs)</p>	<p>New Daily 2002</p> <p>FODERA SEDILE - SERIE TRE POSTI SEDILE GUIDA CON PASSAGGIO POGGIATESTA E PANCHETTA CON PASSAGGIO CINTURA</p> <p>SEAT COVERS - THREE SEATS SERIES DRIVER'S SEAT WITH CUT OUT FOR HEAD RESTRAINT AND BENCH SEAT WITH CUT OUT FOR SAFETY BELT ANCHORAGE</p> <p>COS.PEL. ref. 7006.00084</p> <p>Colore standard cod. 42 / Standard colour cod. 42</p>
 <p>Colore unico / One colour only</p>	<p>Daily 96</p> <p>SEDUTA SEDILE COMPOSTA DA IMBOTTITURA + FODERA</p> <p>SEAT CUSHION FORMED FROM CUSHIONING + COVER</p> <p>COS.PEL. ref. 7006.10016</p> <p>Colore unico cod. 18 / One colour only cod. 18</p>
 <p>Altri colori disponibili su ordinazione / Other colour against specific order / (min. 3 pcs)</p>	<p>New Daily 2002</p> <p>FODERA SEDILE - SERIE SEI+UNO POSTI SEDILE GUIDA CON PASSAGGIO POGGIATESTA E PANCHETTA 2 POSTI - PANCHETTA 4 POSTI</p> <p>SEAT COVERS - SIX+ONE SEATS SERIES DRIVER'S SEAT WITH CUT OUT FOR HEAD RESTRAINT AND 2-PLACE BENCH SEAT - 4-PLACE BENCH SEAT</p> <p>COS.PEL. ref. 7006.00085</p> <p>Colore standard cod. 42 / Standard colour cod. 42</p>
 <p>Colore unico / One colour only</p>	<p>Daily 94</p> <p>SEDUTA SEDILE COMPOSTA DA IMBOTTITURA + FODERA</p> <p>SEAT CUSHION FORMED FROM CUSHIONING + COVER</p> <p>COS.PEL. ref. 7006.10017</p> <p>Colore unico cod. 19 / One colour only cod. 19</p>
 <p>Altri colori disponibili su ordinazione / Other colour against specific order / (min. 3 pcs)</p>	<p>New Daily 2002</p> <p>FODERA SEDILE - SERIE SEI+UNO POSTI SEDILE GUIDA CON PASSAGGIO POGGIATESTA E PANCHETTA 2 POSTI CON PASSAGGIO CINTURA - PANCHETTA 4 POSTI</p> <p>SEAT COVERS - SIX+ONE SEATS SERIES DRIVER'S SEAT WITH CUT OUT FOR HEAD RESTR. AND 2 P. BENCH S. WITH CUT OUT FOR S.BELT - 4 P. BENCH S.</p> <p>COS.PEL. ref. 7006.00086</p> <p>Colore standard cod. 42 / Standard colour cod. 42</p>
 <p>Colore unico / One colour only</p>	<p>Daily 90</p> <p>SEDUTA SEDILE COMPOSTA DA IMBOTTITURA + FODERA</p> <p>SEAT CUSHION FORMED FROM CUSHIONING + COVER</p> <p>COS.PEL. ref. 7006.10018</p> <p>Colore unico cod. 20 / One colour only cod. 20</p>
 <p>Altri colori disponibili su ordinazione / Other colour against specific order / (min. 3 pcs)</p>	<p>New Daily 2002</p> <p>FODERA SEDILE - SERIE QUATTRO POSTI PANCHETTA POSTERIORE 4 POSTI</p> <p>SEAT COVERS - FOUR SEATS SERIES 4-PLACE REAR BENCH SEAT</p> <p>COS.PEL. ref. 7006.00087</p> <p>Colore standard cod. 42 / Standard colour cod. 42</p>

PARTI DI RICAMBIO ADATTABILI A : **COS.IVE**
 SPARE PARTS SUITABLE TO :

 <p>Altri colori disponibili su ordinazione / Other colour against specific order / (min. 3 pcs)</p>	<p>New Daily 2002 Combi</p> <p>FODERA SEDILE - SERIE TRE+TRE POSTI SEDILE GUIDA - PANCHETTA 2 POSTI CON CINTURA E 3 SEDILI SINGOLI CON CINTURA</p> <p>SEAT COVERS - THREE+THREE SEATS SERIES DRIVER'S SEAT - 2 PLACE BENCH SEAT WITH SAFETY BELT AND 3 SINGLE SEAT WITH SAFETY BELTS</p> <p>COS.PEL. ref. 7006.00088</p> <p>Colore standard cod. 42 / Standard colour cod. 42</p>
 <p>Altri colori disponibili su ordinazione / Other colour against specific order / (min. 3 pcs)</p>	<p>New Daily 2002 Combi</p> <p>FODERA SEDILE - SERIE TRE+SEI POSTI SEDILE GUIDA - PANCHETTA 2 POSTI CON CINTURA E 6 SEDILI SINGOLI CON CINTURA</p> <p>SEAT COVERS - THREE+SIX SEATS SERIES DRIVER'S SEAT - 2 PLACE BENCH SEAT WITH SAFETY BELT AND 6 SINGLE SEAT WITH SAFETY BELTS</p> <p>COS.PEL. ref. 7006.00089</p> <p>Colore standard cod. 42 / Standard colour cod. 42</p>
 <p>Altri colori disponibili su ordinazione / Other colour against specific order / (min. 3 pcs)</p>	<p>New Daily 2002 Combi</p> <p>FODERA SEDILE - SERIE UN POSTO SEDILE POSTERIORE SINGOLO</p> <p>SEAT COVERS - ONE SEAT SERIES SINGLE REAR SEAT</p> <p>COS.PEL. ref. 7006.00090</p> <p>Colore standard cod. 42 / Standard colour cod. 42</p>
 <p>Altri colori disponibili su ordinazione / Other colour against specific order / (min. 3 pcs)</p>	<p>Stralis Active Day/Time</p> <p>FODERA SEDILE - LATO GUIDA POGGIATESTA INCORPORATO</p> <p>SEAT COVER - DRIVER'S SEAT WITH BUILT-IN HEAD RESTRAINT</p> <p>COS.PEL. ref. 7006.00138</p> <p>Colore standard cod. 45 / Standard colour cod. 45</p>
 <p>Altri colori disponibili su ordinazione / Other colour against specific order / (min. 3 pcs)</p>	<p>Stralis Active Day/Time</p> <p>FODERA SEDILE - SERIE DUE POSTI POGGIATESTA INCORPORATI</p> <p>SEAT COVERS - TWO SEATS SERIES WITH BUILT-IN HEAD RESTRAINTS</p> <p>COS.PEL. ref. 7006.00139</p> <p>Colore standard cod. 45 / Standard colour cod. 45</p>
 <p>Colore unico / One colour only</p>	<p>Daily 2000</p> <p>SEDUTA SEDILE COMPOSTA DA IMBOTTITURA + FODERA</p> <p>SEAT CUSHION FORMED FROM CUSHIONING + COVER</p> <p>COS.PEL. ref. 7006.10019</p> <p>Colore unico cod. 17 / One colour only cod. 17</p>
 <p>PVC : Altri colori disponibili su ordinazione / Other colour against specific order / (min. 3 pcs)</p>	<p>Stralis Act.Day-Time / Euro 5</p> <p>COPRICOFANO PVC - CABINA LUNGA - (per favore specificare se cambio manuale o automatico)</p> <p>DASH COVER PVC - LONG CABIN - (please specify if shift is manual or automatic)</p> <p>COS.PEL. ref. 7006.00140 PVC - SENZA FRIGO / WITHOUT FRIDGE Colore standard cod. 38 / Standard colour cod. 38</p> <p>COS.PEL. ref. 7006.00141 PVC - CON FRIGO / WITH FRIDGE Colore standard cod. 38 / Standard colour cod. 38</p>
 <p>Colore unico / One colour only</p>	<p>Daily 2002</p> <p>SEDUTA SEDILE COMPOSTA DA IMBOTTITURA + FODERA</p> <p>SEAT CUSHION FORMED FROM CUSHIONING + COVER</p> <p>COS.PEL. ref. 7006.10020</p> <p>Colore unico cod. 42 / One colour only cod. 42</p>

 <p>PVC : Altri colori disponibili su ordinazione / Other colour against specific order / (min. 3 pcs)</p>	<p>Stralis Act.Day-Time / Euro 5</p> <p>COPRICOFANO PVC - CABINA CORTA - (per favore specificare se cambio manuale o automatico)</p> <p>DASH COVER PVC - SHORT CAB - (please specify if shift is manual or automatic)</p> <p>COS.PEL. ref. 7006.00142 PVC - SENZA FRIGO / WITHOUT FRIDGE Colore standard cod. 38 / Standard colour cod. 38</p>
 <p>PVC : Altri colori disponibili su ordinazione / Other colour against specific order / (min. 3 pcs)</p>	<p>Stralis Act.Day-Time / Euro 5 / Hi Street Road</p> <p>TAPPETO FLOOR MAT</p> <p>COS.PEL. ref. 7006.00144 PVC Colore standard cod. 38 / Standard colour cod. 38</p> <p>COS.PEL. ref. 7006.00145 MOQUETTES / CARPETED Colore unico cod. 41 / One colour only cod. 41</p>
 <p>Colore unico / One colour only</p>	<p>Eurocargo Active Day 1a Serie</p> <p>SEDUTA SEDILE PER SEDILE PNEUMATICO COMPOSTA DA: IMBOTTITURA + FODERA</p> <p>SEAT CUSHION WITH COVER FOR PNEUMATIC SEAT FORMED FROM CUSHIONING + COVER</p> <p>COS.PEL. ref. 7006.10007 Colore unico cod. 45 / One colour only cod. 45</p>
 <p>Altri colori disponibili su ordinazione / Other colour against specific order / (min. 3 pcs)</p>	<p>Stralis Hi Way</p> <p>FODERA SEDILE - LATO GUIDA POGGIATESTA INCORPORATO - COLORE UNICO</p> <p>SEAT COVER - DRIVER'S SEAT WITH BUILT-IN HEAD RESTRAINT - PLAIN COLOUR</p> <p>COS.PEL. ref. 7006.00152 Colore standard cod. 59 / Standard colour cod. 59</p>
 <p>Altri colori disponibili su ordinazione / Other colour against specific order / (min. 3 pcs)</p>	<p>Stralis Hi Way</p> <p>FODERA SEDILE - LATO GUIDA POGGIATESTA INCORPORATO - BICOLORE CON ALCANTARA</p> <p>SEAT COVER - DRIVER'S SEAT WITH BUILT-IN HEAD RESTRAINT - 2 COLOURS WITH ALCANTARA</p> <p>COS.PEL. ref. 7006.00153 Colore standard cod. 59+59bis / Standard colour cod. 59+59bis</p>
 <p>Altri colori disponibili su ordinazione / Other colour against specific order / (min. 3 pcs)</p>	<p>Stralis Hi Way</p> <p>FODERA SEDILE - SERIE DUE POSTI POGGIATESTA INCORPORATI - COLORE UNICO</p> <p>SEAT COVERS - TWO SEATS SERIES WITH BUILT-IN HEAD RESTRAINTS - PLAIN COLOURS</p> <p>COS.PEL. ref. 7006.00154 Colore standard cod. 59 / Standard colour cod. 59</p>
 <p>Altri colori disponibili su ordinazione / Other colour against specific order / (min. 3 pcs)</p>	<p>Stralis Hi Way</p> <p>FODERA SEDILE - SERIE DUE POSTI POGGIATESTA INCORPORATI - BICOLORE CON ALCANTARA</p> <p>SEAT COVERS - TWO SEATS SERIES WITH BUILT-IN HEAD RESTRAINTS - 2 COLOURS WITH ALCANTARA</p> <p>COS.PEL. ref. 7006.00155 Colore standard cod. 59+59bis / Standard colour cod. 59+59bis</p>
 <p>Altri colori disponibili su ordinazione / Other colour against specific order / (min. 3 pcs)</p>	<p>Stralis Hi Way</p> <p>FODERA SEDILE - LATO GUIDA POGGIATESTA INCORPORATO - COLORE UNICO NERO</p> <p>SEAT COVER - DRIVER'S SEAT WITH BUILT-IN HEAD RESTRAINT - PLAIN COLOUR BLACK</p> <p>COS.PEL. ref. 7006.00156 Colore standard cod. 58 / Standard colour cod. 58</p>

PARTI DI RICAMBIO ADATTABILI A : **COS.IVE**
SPARE PARTS SUITABLE TO :

	<p>Stralis Hi Way</p> <p>FODERA SEDILE - SERIE DUE POSTI POGGIATESTA INCORPORATI - COLORE UNICO NERO</p> <p>SEAT COVERS - TWO SEATS SERIES WITH BUILT-IN HEAD RESTRAINTS - PLAIN COLOUR BLACK</p> <p>COS.PEL. ref. 7006.00157</p> <p>Colore unico cod. 58 / One colour only cod. 58</p>
<p>Altri colori disponibili su ordinazione / Other colour against specific order / (min. 3 pcs)</p>	<p>Stralis Active Space</p> <p>FODERA SEDILE - LATO GUIDA SEDILE GUIDA POGGIATESTA INCORPORATO VELLUTO</p> <p>SEAT COVER - DRIVER'S SEAT DRIVER'S SEAT WITH VELVET BUILT-IN HEAD RESTRAINT</p> <p>COS.PEL. ref. 7006.00118</p> <p>Colore standard cod. 44 / Standard colour cod. 44</p>
<p>PVC : Altri colori disponibili su ordinazione / Other colour against specific order / (min. 3 pcs)</p>	<p>Stralis Hi Way</p> <p>COPRICOFANO CABINA - CAMBIO MANUALE - CON 2 SEDILI</p> <p>DASH COVER CABIN - MANUAL SHIFT - WITH 2 SEATS</p> <p>COS.PEL. ref. 7006.00158</p> <p>PVC Colore standard cod. 38 / Standard colour cod. 38</p> <p>COS.PEL. ref. 7006.00159</p> <p>MOQUETTES / CARPETED Colore unico cod. 41 / One colour only cod. 41</p>
<p>Altri colori disponibili su ordinazione / Other colour against specific order / (min. 3 pcs)</p>	<p>Stralis Active Space</p> <p>FODERA SEDILE - SERIE DUE POSTI SEDILI POGGIATESTA INCORPORATI VELLUTO</p> <p>SEAT COVERS - TWO SEATS SERIES SEATS WITH VELVET BUILT-IN HEAD RESTRAINT</p> <p>COS.PEL. ref. 7006.00119</p> <p>Colore standard cod. 44 / Standard colour cod. 44</p>
<p>Altri colori disponibili su ordinazione / Other colour against specific order / (min. 3 pcs)</p>	<p>Eurostar</p> <p>FODERA SEDILE - SERIE DUE POSTI 2 SEDILI CON PASSAGGIO CINTURE</p> <p>SEAT COVERS - TWO SEATS SERIES 2 SEATS WITH CUT OUT FOR SEAT BELT ANCHORAGE</p> <p>COS.PEL. ref. 7006.00045</p> <p>Colore standard cod. 16 / Standard colour cod. 16</p>
<p>Colore unico / One colour only</p>	<p>Stralis Active Space / Stralis Active Space Euro 5</p> <p>COPRICOFANO MOQUETTES - CABINA - CAMBIO MANUALE</p> <p>DASH COVER CARPETED - CABIN - MANUAL GEARBOX</p> <p>COS.PEL. ref. 7006.00120</p> <p>MOQUETTES / CARPETED - CON 1 SEDILE / WITH 1 SEAT Colore unico cod. 41 / One colour only cod. 41</p> <p>COS.PEL. ref. 7006.00121</p> <p>MOQUETTES / CARPETED - CON 2 SEDILI / WITH 2 SEATS Colore unico cod. 41 / One colour only cod. 41</p>
<p>PVC : Altri colori disponibili su ordinazione / Other colour against specific order / (min. 3 pcs)</p>	<p>Stralis Hi Way</p> <p>COPRICOFANO PVC - CABINA - CAMBIO AL VOLANTE - CON 2 SEDILI</p> <p>DASH COVER PVC - CABIN - STEERING WHEEL PADDLE SHIFTERS - WITH 2 SEATS</p> <p>COS.PEL. ref. 7006.00160</p> <p>PVC Colore standard cod. 38 / Standard colour cod. 38</p> <p>COS.PEL. ref. 7006.00161</p> <p>PVC - CON PORTAOGGETTI / WITH GLOVE COMPARTMENT Colore standard cod. 38 / Standard colour cod. 38</p>
<p>Altri colori disponibili su ordinazione / Other colour against specific order / (min. 3 pcs)</p>	<p>Eurostar</p> <p>FODERA SEDILE - SERIE DUE POSTI 2 POSTI CON SEDILE GUIDA DIVISO</p> <p>SEAT COVERS - TWO SEATS SERIES 2 SEATS WITH SEPARATED DRIVER'S SEAT</p> <p>COS.PEL. ref. 7006.00046</p> <p>Colore standard cod. 16 / Standard colour cod. 16</p>

 <p>Altri colori disponibili su ordinazione / Other colour against specific order / (min. 3 pcs)</p>	<p>Eurostar</p> <p>FODERA SEDILE - SERIE DUE POSTI SEDILE GUIDA DIVISO, SEDILE DX SENZA CINTURE</p> <p>SEAT COVERS - TWO SEATS SERIES SEPARATED DRIVER'S SEAT, RIGHT SEAT WITHOUT SAFETY-BELT</p> <p>COS.PEL. ref. 7006.00047</p> <p>Colore standard cod. 16 / Standard colour cod. 16</p>
 <p>PVC : Altri colori disponibili su ordinazione / Other colour against specific order / (min. 3 pcs)</p>	<p>Stralis Active Space / Stralis Active Space Euro 5</p> <p>COPRICOFANO PVC - CABINA - CAMBIO MANUALE</p> <p>DASH COVER PVC - CABIN - MANUAL GEARBOX</p> <p>COS.PEL. ref. 7006.00122</p> <p>PVC - CON 1 SEDILE / WITH 1 SEAT Colore standard cod. 38 / Standard colour cod. 38</p> <p>COS.PEL. ref. 7006.00123</p> <p>PVC - CON 1 SEDILE CON ALETTE LATERALI / WITH 1 SEAT WITH SIDE WINGS Colore standard cod. 38 / Standard colour cod. 38</p>
 <p>PVC : Altri colori disponibili su ordinazione / Other colour against specific order / (min. 3 pcs)</p>	<p>Stralis Hi Way</p> <p>COPRICOFANO PVC - CABINA - CON 2 SEDILI - CON ALETTE LATERALI</p> <p>DASH COVER PVC - CABIN - WITH 2 SEATS - WITH SIDE WINGS</p> <p>COS.PEL. ref. 7006.00162</p> <p>PVC Colore standard cod. 38 / Standard colour cod. 38</p>
 <p>Altri colori disponibili su ordinazione / Other colour against specific order / (min. 3 pcs)</p>	<p>Eurostar</p> <p>FODERA SEDILE - LATO GUIDA SEDILE LATO GUIDA CON PASSAGGIO CINTURE E POGGIATESTA</p> <p>SEAT COVER - DRIVER'S SEAT DRIVER'S SEAT WITH CUT OUT FOR SAFETY BELT ANCHORAGE AND HEAD RESTRAINT</p> <p>COS.PEL. ref. 7006.00048</p> <p>Colore standard cod. 16 / Standard colour cod. 16</p>
 <p>Altri colori disponibili su ordinazione / Other colour against specific order / (min. 3 pcs)</p>	<p>Eurostar</p> <p>FODERA SEDILE - LATO GUIDA SEDILE GUIDA DIVISO CON PASSAGGIO CINTURE E POGGIATESTA</p> <p>SEAT COVER - DRIVER'S SEAT SEPARATED DRIVER'S SEAT WITH CUT OUT FOR SAFETY BELT ANCHORAGE AND HEAD RESTRAINT</p> <p>COS.PEL. ref. 7006.00049</p> <p>Colore standard cod. 16 / Standard colour cod. 16</p>
 <p>Colore unico / One colour only</p>	<p>Stralis Active Space / Stralis Active Space Euro 5</p> <p>COPRICOFANO MOQUETTES - CABINA - CAMBIO MANUALE</p> <p>DASH COVER CARPETED - CABIN - MANUAL GEARBOX</p> <p>COS.PEL. ref. 7006.00120</p> <p>MOQUETTES / CARPETED - CON 1 SEDILE / WITH 1 SEAT Colore unico cod. 41 / One colour only cod. 41</p> <p>COS.PEL. ref. 7006.00121</p> <p>MOQUETTES / CARPETED - CON 2 SEDILI / WITH 2 SEATS Colore unico cod. 41 / One colour only cod. 41</p>
 <p>PVC : Altri colori disponibili su ordinazione / Other colour against specific order / (min. 3 pcs)</p>	<p>Stralis Active Space / Stralis Active Space Euro 5</p> <p>COPRICOFANO PVC - CABINA - CAMBIO MANUALE</p> <p>DASH COVER PVC - CABIN - MANUAL GEARBOX</p> <p>COS.PEL. ref. 7006.00124</p> <p>PVC - CON 2 SEDILI / WITH 2 SEATS Colore standard cod. 38 / Standard colour cod. 38</p> <p>COS.PEL. ref. 7006.00125</p> <p>PVC - CON 2 SEDILI CON ALETTE LATERALI / WITH 2 SEATS WITH SIDE WINGS Colore standard cod. 38 / Standard colour cod. 38</p>
 <p>Colore unico / One colour only</p>	<p>Stralis Hi Way</p> <p>COPRICOFANO MOQUETTES - CABINA - CAMBIO AL VOLANTE - CON 2 SEDILI</p> <p>DASH COVER CARPETED - CABIN - STEERING WHEEL PADDLE SHIFTERS - WITH 2 SEATS</p> <p>COS.PEL. ref. 7006.00163</p> <p>MOQUETTES / CARPETED Colore unico cod. 41 / One colour only cod. 41</p> <p>COS.PEL. ref. 7006.00164</p> <p>MOQUETTES / CARPETED - CON PORTAOGGETTI / WITH GLOVE COMPARTMENT Colore unico cod. 41 / One colour only cod. 41</p>

PARTI DI RICAMBIO ADATTABILI A : **COS.IVE**
 SPARE PARTS SUITABLE TO :

 <p>PVC : Altri colori disponibili su ordinazione / Other colour against specific order / (min. 3 pcs)</p>	<p>Eurostar</p> <p>COPRICOFANO PVC - TERMOSALDATO - CABINA LUNGA</p> <p>DASH COVER PVC - HEAT-SEALED FOR LONG CAB</p> <p>COS.PEL. ref. 7006.00050 PVC Colore standard cod. 38 / Standard colour cod. 38</p>
 <p>Altri colori disponibili su ordinazione / Other colour against specific order / (min. 3 pcs)</p>	<p>Stralis Hi Street-Road</p> <p>FODERA SEDILE - LATO GUIDA POGGIATESTA INCORPORATO</p> <p>SEAT COVER - DRIVER'S SEAT WITH BUILT-IN HEAD RESTRAINTS</p> <p>COS.PEL. ref. 7006.00165</p> <p>Colore standard cod. 56 / Standard colour cod. 56</p>
 <p>PVC : Altri colori disponibili su ordinazione / Other colour against specific order / (min. 3 pcs)</p>	<p>Eurostar</p> <p>TAPPETO FLOOR MAT</p> <p>COS.PEL. ref. 7006.00051 PVC Colore standard cod. 38 / Standard colour cod. 38</p> <p>COS.PEL. ref. 7006.00052 MOQUETTES / CARPETED Colore unico cod. 41 / One colour only cod. 41</p>
 <p>PVC : Altri colori disponibili su ordinazione / Other colour against specific order / (min. 3 pcs)</p>	<p>Stralis Active Space / Stralis Active Space Euro 5</p> <p>COPRICOFANO PVC - CABINA - CAMBIO MANUALE</p> <p>DASH COVER PVC - CABIN - MANUAL GEARBOX</p> <p>COS.PEL. ref. 7006.00122 PVC - CON 1 SEDILE / WITH 1 SEAT Colore standard cod. 38 / Standard colour cod. 38</p> <p>COS.PEL. ref. 7006.00123 PVC - CON 1 SEDILE CON ALETTE LATERALI / WITH 1 SEAT WITH SIDE WINGS Colore standard cod. 38 / Standard colour cod. 38</p>
 <p>PVC : Altri colori disponibili su ordinazione / Other colour against specific order / (min. 3 pcs)</p>	<p>Stralis Act. Space / Stralis Act. Space Euro 5 / Hi-Way</p> <p>TAPPETO FLOOR MAT</p> <p>COS.PEL. ref. 7006.00126 PVC Colore standard cod. 38 / Standard colour cod. 38</p> <p>COS.PEL. ref. 7006.00127 MOQUETTES / CARPETED Colore unico cod. 41 / One colour only cod. 41</p>
 <p>PVC : Altri colori disponibili su ordinazione / Other colour against specific order / (min. 3 pcs)</p>	<p>Stralis Act.Day-Time / Euro 5</p> <p>COPRICOFANO PVC - CABINA LUNGA - (per favore specificare se cambio manuale o automatico)</p> <p>DASH COVER PVC - LONG CABIN - (please specify if shift is manual or automatic)</p> <p>COS.PEL. ref. 7006.00140 PVC - SENZA FRIGO / WITHOUT FRIDGE Colore standard cod. 38 / Standard colour cod. 38</p> <p>COS.PEL. ref. 7006.00141 PVC - CON FRIGO / WITH FRIDGE Colore standard cod. 38 / Standard colour cod. 38</p>
 <p>Altri colori disponibili su ordinazione / Other colour against specific order / (min. 3 pcs)</p>	<p>Stralis Hi Street-Road</p> <p>FODERA SEDILE - SERIE DUE POSTI POGGIATESTA INCORPORATI</p> <p>SEAT COVERS - TWO SEATS SERIES WITH BUILT-IN HEAD RESTRAINTS</p> <p>COS.PEL. ref. 7006.00166</p> <p>Colore standard cod. 56 / Standard colour cod. 56</p>
 <p>Altri colori disponibili su ordinazione / Other colour against specific order / (min. 3 pcs)</p>	<p>Stralis Hi Street-Road</p> <p>FODERA SEDILE - LATO GUIDA POGGIATESTA INCORPORATO - BICOLORE</p> <p>SEAT COVER - DRIVER'S SEAT WITH BUILT-IN HEAD RESTRAINT - 2 COLOURS</p> <p>COS.PEL. ref. 7006.00167</p> <p>Colore standard cod. 55+55bis / Standard colour cod. 55+55bis</p>

 <p>PVC : Altri colori disponibili su ordinazione / Other colour against specific order / (min. 3 pcs)</p>	<p>Stralis Active Space / Stralis Active Space Euro 5</p> <p>COPRICOFANO PVC - CABINA - CAMBIO MANUALE DASH COVER PVC - CABIN - MANUAL GEARBOX COS.PEL. ref. 7006.00124 PVC - CON 2 SEDILI / WITH 2 SEATS Colore standard cod. 38 / Standard colour cod. 38 COS.PEL. ref. 7006.00125 PVC - CON 2 SEDILI CON ALETTE LATERALI / WITH 2 SEATS WITH SIDE WINGS Colore standard cod. 38 / Standard colour cod. 38</p>
 <p>PVC : Altri colori disponibili su ordinazione / Other colour against specific order / (min. 3 pcs)</p>	<p>Stralis Act.Day-Time / Euro 5</p> <p>COPRICOFANO PVC - CABINA CORTA - (per favore specificare se cambio manuale o automatico) DASH COVER PVC - SHORT CAB - (please specify if shift is manual or automatic) COS.PEL. ref. 7006.00142 PVC - SENZA FRIGO / WITHOUT FRIDGE Colore standard cod. 38 / Standard colour cod. 38</p>
 <p>Altri colori disponibili su ordinazione / Other colour against specific order / (min. 3 pcs)</p>	<p>Stralis Hi Street-Road</p> <p>FODERA SEDILE - SERIE DUE POSTI POGGIATESTA INCORPORATI - BICOLORE SEAT COVERS - TWO SEATS SERIES WITH BUILT-IN HEAD RESTRAINTS - 2 COLOURS COS.PEL. ref. 7006.00168 Colore standard cod. 55+55bis / Standard colour cod. 55+55bis</p>
 <p>Colore unico / One colour only</p>	<p>Stralis As 1a Serie</p> <p>SEDUTA SEDILE PER SEDILE PNEUMATICO COMPOSTA DA: IMBOTTITURA + FODERA VELLUTO SEAT CUSHION WITH COVER FOR PNEUMATIC SEAT FORMED FROM CUSHIONING + VELVET COVER COS.PEL. ref. 7006.10008 Colore unico cod. 44 / One colour only cod. 44</p>
 <p>Colore unico / One colour only</p>	<p>Eurostar</p> <p>SEDUTA SEDILE PER SEDILE PNEUMATICO COMPOSTA DA: IMBOTTITURA + FODERA VELLUTO SEAT CUSHION WITH COVER FOR PNEUMATIC SEAT FORMED FROM CUSHIONING + VELVET COVER COS.PEL. ref. 7006.10013 Colore unico cod. 16 / One colour only cod. 16</p>
 <p>PVC : Altri colori disponibili su ordinazione / Other colour against specific order / (min. 3 pcs)</p>	<p>Stralis Act.Day-Time / Euro 5 / Hi Street Road</p> <p>TAPPETO FLOOR MAT COS.PEL. ref. 7006.00144 PVC Colore standard cod. 38 / Standard colour cod. 38 COS.PEL. ref. 7006.00145 MOQUETTES / CARPETED Colore unico cod. 41 / One colour only cod. 41</p>
 <p>PVC : Altri colori disponibili su ordinazione / Other colour against specific order / (min. 3 pcs)</p>	<p>Stralis Hi Street Road</p> <p>COPRICOFANO PVC - CABINA LUNGA - (per favore specificare se cambio manuale o automatico) DASH COVER PVC - LONG CABIN - (please specify if shift is manual or automatic) COS.PEL. ref. 7006.00170 PVC - SENZA FRIGO / WITHOUT FRIDGE Colore standard cod. 38 / Standard colour cod. 38</p>
 <p>PVC : Altri colori disponibili su ordinazione / Other colour against specific order / (min. 3 pcs)</p>	<p>Stralis Act. Space / Stralis Act. Space Euro 5 / Hi-Way</p> <p>TAPPETO FLOOR MAT COS.PEL. ref. 7006.00126 PVC Colore standard cod. 38 / Standard colour cod. 38 COS.PEL. ref. 7006.00127 MOQUETTES / CARPETED Colore unico cod. 41 / One colour only cod. 41</p>

ALL ITEMS MENTIONED IN OUR CATALOGUE ARE NOT ORIGINAL PARTS BUT PERFECTLY INTERCHANGEABLE WITH THEM.

GOVERNING LEGISLATIONS FOR THE SALE OF OUR PRODUCTS DIFFER IN EACH COUNTRY.

INFRINGEMENTS, IF ANY, OF LOCAL LEGISLATIONS ARE RESPONSIBILITY OF THE RETAILER IN THE COUNTRY OF FINAL DISTRIBUTION.



PARTI DI RICAMBIO ADATTABILI A : **COS.IVE**
 SPARE PARTS SUITABLE TO :

 <p>PVC : Altri colori disponibili su ordinazione / Other colour against specific order / (min. 3 pcs)</p>	<p>Stralis Hi Street Road</p> <p>COPRICOFANO PVC - CABINA LUNGA - (per favore specificare se cambio manuale o automatico)</p> <p>DASH COVER PVC - LONG CABIN - (please specify if shift is manual or automatic)</p> <p>COS.PEL. ref. 7006.00171 PVC - CON FRIGO / WITH FRIDGE Colore standard cod. 38 / Standard colour cod. 38</p>
 <p>Altri colori disponibili su ordinazione / Other colour against specific order / (min. 3 pcs)</p>	<p>Stralis Active Day/Time Euro 5</p> <p>FODERA SEDILE - LATO GUIDA POGGIATESTA INCORPORATO</p> <p>SEAT COVER - DRIVER'S SEAT WITH BUILT-IN HEAD RESTRAINT</p> <p>COS.PEL. ref. 7006.00146</p> <p>Colore standard cod. 49 / Standard colour cod. 49</p>
 <p>PVC : Altri colori disponibili su ordinazione / Other colour against specific order / (min. 3 pcs)</p>	<p>Stralis Hi Street Road</p> <p>COPRICOFANO PVC - CABINA CORTA - (per favore specificare se cambio manuale o automatico)</p> <p>DASH COVER PVC - SHORT CAB - (please specify if shift is manual or automatic)</p> <p>COS.PEL. ref. 7006.00172 PVC - SENZA FRIGO / WITHOUT FRIDGE Colore standard cod. 38 / Standard colour cod. 38</p>
 <p>Altri colori disponibili su ordinazione / Other colour against specific order / (min. 3 pcs)</p>	<p>Eurotech 98 Seconda Serie</p> <p>FODERA SEDILE - SERIE DUE POSTI 2 SEDILI PNEUMATICI - PASSAGGIO CINTURE E 2 POGGIATESTA</p> <p>SEAT COVERS - TWO SEATS SERIES 2 PNEUMATIC SEATS - SAFETY BELTS AND 2 HEAD RESTRAINTS</p> <p>COS.PEL. ref. 7006.00032</p> <p>Colore standard cod. 12 / Standard colour cod. 12</p>
 <p>Altri colori disponibili su ordinazione / Other colour against specific order / (min. 3 pcs)</p>	<p>Stralis Active Space Euro 5</p> <p>FODERA SEDILE - LATO GUIDA SEDILE GUIDA POGGIATESTA INCORPORATO - COLORE UNICO</p> <p>SEAT COVER - DRIVER'S SEAT DRIVER'S SEAT WITH BUILT-IN HEAD RESTRAINT - PLAIN COLOUR</p> <p>COS.PEL. ref. 7006.00128</p> <p>Colore standard cod. 50 / Standard colour cod. 50</p>
 <p>Altri colori disponibili su ordinazione / Other colour against specific order / (min. 3 pcs)</p>	<p>Stralis Active Day/Time Euro 5</p> <p>FODERA SEDILE - SERIE DUE POSTI POGGIATESTA INCORPORATI</p> <p>SEAT COVERS - TWO SEATS SERIES WITH BUILT-IN HEAD RESTRAINTS</p> <p>COS.PEL. ref. 7006.00147</p> <p>Colore standard cod. 49 / Standard colour cod. 49</p>
 <p>PVC : Altri colori disponibili su ordinazione / Other colour against specific order / (min. 3 pcs)</p>	<p>Stralis Hi Street Road</p> <p>COPRICOFANO PVC - CABINA LUNGA - CAMBIO AL VOLANTE</p> <p>DASH COVER PVC - LONG CABIN - STEERING WHEEL PADDLE SHIFTERS</p> <p>COS.PEL. ref. 7006.00173 PVC - SENZA FRIGO / WITHOUT FRIDGE Colore standard cod. 38 / Standard colour cod. 38</p>
 <p>Altri colori disponibili su ordinazione / Other colour against specific order / (min. 3 pcs)</p>	<p>Eurotech 98 Seconda Serie</p> <p>FODERA SEDILE - SERIE DUE POSTI SEDILE SX PNEUMATICO - SEDILE DESTRO CON SCHIENALE BASSO</p> <p>SEAT COVERS - TWO SEATS SERIES PNEUMATIC LH SEAT - RIGHT SEAT WITH LOW-BACK BACKREST</p> <p>COS.PEL. ref. 7006.00033</p> <p>Colore standard cod. 12 / Standard colour cod. 12</p>





 <p>Altri colori disponibili su ordinazione / Other colour against specific order / (min. 3 pcs)</p>	<p>Stralis Active Space Euro 5</p> <p>FODERA SEDILE - LATO GUIDA SEDILE GUIDA POGGIATESTA INCORPORATO - BICOLORE CON ALCANTARA</p> <p>SEAT COVER - DRIVER'S SEAT DRIVER'S SEAT WITH BUILT-IN HEAD RESTRAINT - 2 COLOURS WITH ALCANTARA SE.CO.</p> <p>COS.PEL. ref. 7006.00129</p> <p>Colore standard cod. 50+50bis / Standard colour cod. 50+50bis</p>
 <p>PVC : Altri colori disponibili su ordinazione / Other colour against specific order / (min. 3 pcs)</p>	<p>Stralis Active Day-Time Euro 5</p> <p>COPRICOFANO PVC - CABINA LUNGA - CAMBIO AL VOLANTE</p> <p>DASH COVER PVC - LONG CABIN - STEERING WHEEL PADDLE SHIFTERS</p> <p>COS.PEL. ref. 7006.00148</p> <p>PVC - SENZA FRIGO / WITHOUT FRIDGE Colore standard cod. 38 / Standard colour cod. 38</p> <p>COS.PEL. ref. 7006.00149</p> <p>PVC - CON FRIGO / WITH FRIDGE Colore standard cod. 38 / Standard colour cod. 38</p>
 <p>PVC : Altri colori disponibili su ordinazione / Other colour against specific order / (min. 3 pcs)</p>	<p>Stralis Hi Street Road</p> <p>COPRICOFANO PVC - CABINA LUNGA - CAMBIO AL VOLANTE</p> <p>DASH COVER PVC - LONG CABIN - STEERING WHEEL PADDLE SHIFTERS</p> <p>COS.PEL. ref. 7006.00174</p> <p>PVC - CON FRIGO / WITH FRIDGE Colore standard cod. 38 / Standard colour cod. 38</p>
 <p>Altri colori disponibili su ordinazione / Other colour against specific order / (min. 3 pcs)</p>	<p>Eurotech 98 Seconda Serie</p> <p>FODERA SEDILE - LATO GUIDA SEDILE PNEUMATICO</p> <p>SEAT COVER - DRIVER'S SEAT PNEUMATIC SEAT</p> <p>COS.PEL. ref. 7006.00034</p> <p>Colore standard cod. 12 / Standard colour cod. 12</p>
 <p>Altri colori disponibili su ordinazione / Other colour against specific order / (min. 3 pcs)</p>	<p>Stralis Active Space Euro 5</p> <p>FODERA SEDILE - SERIE DUE POSTI DUE POSTI CON POGGIATESTA INCORPORATO - COLORE UNICO</p> <p>SEAT COVERS - TWO SEATS SERIES 2 SEATS WITH BUILT-IN HEAD RESTRAINTS - PLAIN COLOURS</p> <p>COS.PEL. ref. 7006.00130</p> <p>Colore standard cod. 50 / Standard colour cod. 50</p>
 <p>PVC : Altri colori disponibili su ordinazione / Other colour against specific order / (min. 3 pcs)</p>	<p>Stralis Hi Street Road</p> <p>COPRICOFANO PVC - CABINA CORTA - CAMBIO AL VOLANTE</p> <p>DASH COVER PVC - SHORT CABIN - STEERING WHEEL PADDLE SHIFTERS</p> <p>COS.PEL. ref. 7006.00175</p> <p>PVC - SENZA FRIGO / WITHOUT FRIDGE Colore standard cod. 38 / Standard colour cod. 38</p>
 <p>Altri colori disponibili su ordinazione / Other colour against specific order / (min. 3 pcs)</p>	<p>Stralis Active Space Euro 5</p> <p>FODERA SEDILE - SERIE DUE POSTI SEDILE GUIDA POGGIATESTA INCORPORATO - BICOLORE CON ALCANTARA</p> <p>SEAT COVERS - TWO SEATS SERIES DRIVER'S SEAT WITH BUILT-IN HEAD RESTRAINT - 2 COLOURS WITH ALCANTARA</p> <p>COS.PEL. ref. 7006.00131</p> <p>Colore standard cod. 50+50bis / Standard colour cod. 50+50bis</p>
 <p>PVC : Altri colori disponibili su ordinazione / Other colour against specific order / (min. 3 pcs)</p>	<p>Stralis Active Day-Time Euro 5</p> <p>COPRICOFANO PVC - CABINA CORTA - CAMBIO AL VOLANTE</p> <p>DASH COVER PVC - SHORT CABIN - STEERING WHEEL PADDLE SHIFTERS</p> <p>COS.PEL. ref. 7006.00150</p> <p>PVC - SENZA FRIGO / WITHOUT FRIDGE Colore standard cod. 38 / Standard colour cod. 38</p>

PARTI DI RICAMBIO ADATTABILI A :
SPARE PARTS SUITABLE TO : **COS.IVE**

 <p>GOMMA : Altri colori disponibili su ordinazione / Other colour against specific order / (min. 3 pcs)</p>	<p>Stralis Hi Street Road</p> <p>TAPPETO GOMMA MILLERIGHE</p> <p>FLOOR MAT RUBBER</p> <p>COS.PEL. ref. 7006.00176 GOMMA/RUBBER</p>
 <p>PVC : Altri colori disponibili su ordinazione / Other colour against specific order / (min. 3 pcs)</p>	<p>Eurotech 98 Seconda Serie</p> <p>COPRICOFANO PVC - TERMOSALDATO DASH COVER PVC - HEAT-SEALED</p> <p>COS.PEL. ref. 7006.00035 PVC - CABINA LUNGA / LONG CABIN Colore standard cod. 38 / Standard colour cod. 38</p> <p>COS.PEL. ref. 7006.00036 PVC - CABINA CORTA / SHORT CABIN Colore standard cod. 38 / Standard colour cod. 38</p>
 <p>Colore unico / One colour only</p>	<p>Stralis Active Space Euro 5</p> <p>COPRICOFANO MOQUETTES - CABINA - CAMBIO AL VOLANTE - CON 1 SEDILE</p> <p>DASH COVER CARPETED - CABIN - STEERING WHEEL PADDLE SHIFTER - WITH 1 SEAT</p> <p>COS.PEL. ref. 7006.00132 MOQUETTES / CARPETED Colore unico cod. 41 / One colour only cod. 41</p>
 <p>Colore unico / One colour only</p>	<p>Eurocargo Active Day Euro 5</p> <p>SEDUTA SEDILE PER SEDILE PNEUMATICO COMPOSTA DA: IMBOTTITURA + FODERA</p> <p>SEAT CUSHION WITH COVER FOR PNEUMATIC SEAT FORMED FROM CUSHIONING + COVER</p> <p>COS.PEL. ref. 7006.10006</p> <p>Colore unico cod. 49 / One colour only cod. 49</p>
 <p>PVC : Altri colori disponibili su ordinazione / Other colour against specific order / (min. 3 pcs)</p>	<p>Eurotech 98 Seconda Serie</p> <p>TAPPETO FLOOR MAT</p> <p>COS.PEL. ref. 7006.00037 PVC Colore standard cod. 38 / Standard colour cod. 38</p> <p>COS.PEL. ref. 7006.00038 MOQUETTES / CARPETED Colore unico cod. 41 / One colour only cod. 41</p>
 <p>Colore unico / One colour only</p>	<p>Stralis Active Space Euro 5</p> <p>COPRICOFANO MOQUETTES - CABINA - CAMBIO AL VOLANTE - CON 2 SEDILI</p> <p>DASH COVER CARPETED - CABIN - STEERING WHEEL PADDLE SHIFTER - WITH 2 SEATS</p> <p>COS.PEL. ref. 7006.00133 MOQUETTES / CARPETED Colore unico cod. 41 / One colour only cod. 41</p> <p>COS.PEL. ref. 7006.00134 MOQUETTES / CARPETED - CON PORTAOGGETTI / WITH GLOVE COMPARTMENT Colore unico cod. 41 / One colour only cod. 41</p>
 <p>PVC : Altri colori disponibili su ordinazione / Other colour against specific order / (min. 3 pcs)</p>	<p>Stralis Active Space Euro 5</p> <p>COPRICOFANO PVC - CABINA - CAMBIO AL VOLANTE - CON 1 SEDILE</p> <p>DASH COVER PVC - CABIN - STEERING WHEEL PADDLE SHIFTER - WITH 1 SEAT</p> <p>COS.PEL. ref. 7006.00135 PVC Colore standard cod. 38 / Standard colour cod. 38</p>
 <p>PVC : Altri colori disponibili su ordinazione / Other colour against specific order / (min. 3 pcs)</p>	<p>Stralis Active Space Euro 5</p> <p>COPRICOFANO PVC - CABINA - CAMBIO AL VOLANTE - CON 2 SEDILI</p> <p>DASH COVER PVC - CABIN - STEERING WHEEL PADDLE SHIFTER - WITH 2 SEATS</p> <p>COS.PEL. ref. 7006.00136 PVC Colore standard cod. 38 / Standard colour cod. 38</p> <p>COS.PEL. ref. 7006.00137 PVC - CON PORTAOGGETTI / WITH GLOVE COMPARTMENT Colore standard cod. 38 / Standard colour cod. 38</p>

 <p>Colore unico / One colour only</p>	<p>Eurotech 98</p> <p>SEDUTA SEDILE COMPOSTA DA IMBOTTITURA + FODERA SEAT CUSHION FORMED FROM CUSHIONING + COVER</p> <p>COS.PEL. ref. 7006.10009 SEDILE PNEUMATICO / PNEUMATIC SEAT Colore unico cod. 12 / One colour only cod. 12</p> <p>COS.PEL. ref. 7006.10010 SEDILE FISSO / FIXED SEAT Colore unico cod. 12 / One colour only cod. 12</p>
 <p>PVC : Altri colori disponibili su ordinazione / Other colour against specific order / (min. 3 pcs)</p>	<p>Stralis Active Day-Time Euro 5</p> <p>COPRICOFANO PVC - CABINA LUNGA - CAMBIO AL VOLANTE DASH COVER PVC - LONG CABIN - STEERING WHEEL PADDLE SHIFTERS</p> <p>COS.PEL. ref. 7006.00148 PVC - SENZA FRIGO / WITHOUT FRIDGE Colore standard cod. 38 / Standard colour cod. 38</p> <p>COS.PEL. ref. 7006.00149 PVC - CON FRIGO / WITH FRIDGE Colore standard cod. 38 / Standard colour cod. 38</p>
 <p>Colore unico / One colour only</p>	<p>Eurotech 1a Serie</p> <p>SEDUTA SEDILE COMPOSTA DA IMBOTTITURA + FODERA SEAT CUSHION FORMED FROM CUSHIONING + COVER</p> <p>COS.PEL. ref. 7006.10011 SEDILE PNEUMATICO / PNEUMATIC SEAT Colore unico cod. 13 / One colour only cod. 13</p> <p>COS.PEL. ref. 7006.10012 SEDILE FISSO / FIXED SEAT Colore unico cod. 13 / One colour only cod. 13</p>
 <p>PVC : Altri colori disponibili su ordinazione / Other colour against specific order / (min. 3 pcs)</p>	<p>Stralis Active Day-Time Euro 5</p> <p>COPRICOFANO PVC - CABINA CORTA - CAMBIO AL VOLANTE DASH COVER PVC - SHORT CABIN - STEERING WHEEL PADDLE SHIFTERS</p> <p>COS.PEL. ref. 7006.00150 PVC - SENZA FRIGO / WITHOUT FRIDGE Colore standard cod. 38 / Standard colour cod. 38</p>
 <p>Colore unico / One colour only</p>	<p>Stralis As Euro 5</p> <p>SEDUTA SEDILE COMPOSTA DA IMBOTTITURA + FODERA ALCANTARA SEAT CUSHION FORMED FROM CUSHIONING + ALCANTARA COVER</p> <p>COS.PEL. ref. 7006.10023</p> <p>Colore unico cod. 50bis / One colour only cod. 50bis</p>

PARTI DI RICAMBIO ADATTABILI A : **COS.MA**
SPARE PARTS SUITABLE TO :

 <p>Altri colori disponibili su ordinazione / Other colour against specific order / (min. 3 pcs)</p>	<p>Tg X / L / M 2008</p> <p>FODERA SEDILE - LATO GUIDA POGGIATESTA INCORPORATO</p> <p>SEAT COVER - DRIVER'S SEAT WITH BUILT-IN HEAD RESTRAINT</p> <p>COS.PEL. ref. 7007.00008</p> <p>Colore standard cod. 56 / Standard colour cod. 56</p>
 <p>Altri colori disponibili su ordinazione / Other colour against specific order / (min. 3 pcs)</p>	<p>Tg X / L / M 2008</p> <p>FODERA SEDILE - SERIE DUE POSTI POGGIATESTA INCORPORATI</p> <p>SEAT COVERS - TWO SEATS SERIES WITH BUILT-IN HEAD RESTRAINT</p> <p>COS.PEL. ref. 7007.00009</p> <p>Colore standard cod. 56 / Standard colour cod. 56</p>
 <p>Altri colori disponibili su ordinazione / Other colour against specific order / (min. 3 pcs)</p>	<p>Tg X / L / M 2008</p> <p>FODERA SEDILE - SERIE TRE POSTI POGGIATESTA INCORPORATI</p> <p>SEAT COVERS - THREE SEATS SERIES WITH BUILT-IN HEAD RESTRAINT</p> <p>COS.PEL. ref. 7007.00010</p> <p>Colore standard cod. 56 / Standard colour cod. 56</p>
 <p>Altri colori disponibili su ordinazione / Other colour against specific order / (min. 3 pcs)</p>	<p>Tg X / L / M 2008</p> <p>FODERA SEDILE - SERIE DUE POSTI POGGIATESTA INCORPORATI - SEDILE DX SENZA CINTURA</p> <p>SEAT COVERS - TWO SEATS SERIES WITH BUILT-IN HEAD RESTRAINT - RH SIDE : WITHOUT CUT OUT FOR SAFETY BELT</p> <p>COS.PEL. ref. 7007.00011</p> <p>Colore standard cod. 56 / Standard colour cod. 56</p>
 <p>PVC : Altri colori disponibili su ordinazione / Other colour against specific order / (min. 3 pcs)</p>	<p>Tg X / L / M 2008</p> <p>TAPPETO FLOOR MAT</p> <p>COS.PEL. ref. 7007.00012 PVC Colore standard cod. 38 / Standard colour cod. 38</p> <p>COS.PEL. ref. 7007.00013 MOQUETTES / CARPETED Colore unico cod. 41 / One colour only cod. 41</p>
 <p>PVC : Altri colori disponibili su ordinazione / Other colour against specific order / (min. 3 pcs)</p>	<p>Tg X / L / M 2008</p> <p>COPRICOFANO PVC - TERMOSALDATO - CABINA CORTA</p> <p>DASH COVER PVC - HEAT-SEALED - SHORT CAB</p> <p>COS.PEL. ref. 7007.00014 PVC - CAMBIO MANUALE / MANUAL GEARBOX Colore standard cod. 38 / Standard colour cod. 38</p> <p>COS.PEL. ref. 7007.00015 PVC - CAMBIO AUTOMATICO / AUTOMATIC GEARBOX Colore standard cod. 38 / Standard colour cod. 38</p>
 <p>PVC : Altri colori disponibili su ordinazione / Other colour against specific order / (min. 3 pcs)</p>	<p>Tg X / L / M 2008</p> <p>COPRICOFANO PVC - TERMOSALDATO - CABINA LUNGA</p> <p>DASH COVER PVC - HEAT-SEALED - LONG CAB</p> <p>COS.PEL. ref. 7007.00016 PVC - CAMBIO MANUALE / MANUAL GEARBOX Colore standard cod. 38 / Standard colour cod. 38</p> <p>COS.PEL. ref. 7007.00017 PVC - CAMBIO AUTOMATICO / AUTOMATIC GEARBOX Colore standard cod. 38 / Standard colour cod. 38</p>
 <p>Altri colori disponibili su ordinazione / Other colour against specific order / (min. 3 pcs)</p>	<p>Tg X 2014</p> <p>FODERA SEDILE - LATO GUIDA POGGIATESTA INCORPORATO - PASSAGGIO CINTURA</p> <p>SEAT COVER - DRIVER'S SEAT WITH BUILT-IN HEAD RESTRAINT - CUT OUT FOR SAFETY BELT</p> <p>COS.PEL. ref. 7007.00018</p> <p>Colore standard cod. 56 / Standard colour cod. 56</p>

 <p>Altri colori disponibili su ordinazione / Other colour against specific order / (min. 3 pcs)</p>	<p>Tg X 2014</p> <p>FODERA SEDILE - SERIE DUE POSTI POGGIATESTA INCORPORATO - PASSAGGIO CINTURA</p> <p>SEAT COVERS - TWO SEATS SERIES BUILT-IN HEAD RESTRAINT - CUT OUT FOR SAFETY BELT</p> <p>COS.PEL. ref. 7007.00019</p> <p>Colore standard cod. 56 / Standard colour cod. 56</p>
 <p>Altri colori disponibili su ordinazione / Other colour against specific order / (min. 3 pcs)</p>	<p>Tg X 2014</p> <p>FODERA SEDILE - SERIE TRE POSTI POGGIATESTA INCORPORATO - PASSAGGIO CINTURA</p> <p>SEAT COVERS - THREE SEATS SERIES WITH BUILT-IN HEAD RESTRAINT - CUT OUT FOR SAFETY BELT</p> <p>COS.PEL. ref. 7007.00020</p> <p>Colore standard cod. 56 / Standard colour cod. 56</p>
 <p>Altri colori disponibili su ordinazione / Other colour against specific order / (min. 3 pcs)</p>	<p>Tg A 2008</p> <p>FODERA SEDILE - LATO GUIDA POGGIATESTA INCORPORATO</p> <p>SEAT COVER - DRIVER'S SEAT WITH BUILT-IN HEAD RESTRAINT</p> <p>COS.PEL. ref. 7007.00002</p> <p>Colore standard cod. 56 / Standard colour cod. 56</p>
 <p>Altri colori disponibili su ordinazione / Other colour against specific order / (min. 3 pcs)</p>	<p>Tg X 2014</p> <p>FODERA SEDILE - SERIE DUE POSTI POGGIATESTA INCORPORATI - PASSAGGIO CINTURA - SED. DX : SENZA CINTURE</p> <p>SEAT COVERS - TWO SEATS SERIES BUILT-IN HEAD RESTRAINT - CUT OUT FOR SAFETY BELT - RH SIDE : WITHOUT CUT OUT FOR SAFETY BELT</p> <p>COS.PEL. ref. 7007.00021</p> <p>Colore standard cod. 56 / Standard colour cod. 56</p>
 <p>Altri colori disponibili su ordinazione / Other colour against specific order / (min. 3 pcs)</p>	<p>Tg A 2008</p> <p>FODERA SEDILE - SERIE DUE POSTI POGGIATESTA INCORPORATI</p> <p>SEAT COVERS - TWO SEATS SERIES WITH BUILT-IN HEAD RESTRAINT</p> <p>COS.PEL. ref. 7007.00003</p> <p>Colore standard cod. 56 / Standard colour cod. 56</p>
 <p>PVC : Altri colori disponibili su ordinazione / Other colour against specific order / (min. 3 pcs)</p>	<p>Tg X 2014</p> <p>TAPPETO</p> <p>FLOOR MAT</p> <p>COS.PEL. ref. 7007.00022 PVC Colore standard cod. 38 / Standard colour cod. 38</p> <p>COS.PEL. ref. 7007.00023 MOQUETTES / CARPETED Colore unico cod. 41 / One colour only cod. 41</p>
 <p>PVC : Altri colori disponibili su ordinazione / Other colour against specific order / (min. 3 pcs)</p>	<p>Tg XXL / Tg A</p> <p>TAPPETO</p> <p>FLOOR MAT</p> <p>COS.PEL. ref. 7007.00004 PVC Colore standard cod. 38 / Standard colour cod. 38</p> <p>COS.PEL. ref. 7007.00005 MOQUETTES / CARPETED Colore unico cod. 41 / One colour only cod. 41</p>
 <p>PVC : Altri colori disponibili su ordinazione / Other colour against specific order / (min. 3 pcs)</p>	<p>Tg X 2014</p> <p>COPRICOFANO CAMBIO MANUALE - FRIGO</p> <p>DASH COVER MANUAL GEARBOX - FRIDGE</p> <p>COS.PEL. ref. 7007.00024 PVC Colore standard cod. 38 / Standard colour cod. 38</p> <p>COS.PEL. ref. 7007.00025 MOQUETTES / CARPETED Colore unico cod. 41 / One colour only cod. 41</p>



PARTI DI RICAMBIO ADATTABILI A : **COS.MA**
 SPARE PARTS SUITABLE TO :

 <p>PVC : Altri colori disponibili su ordinazione / Other colour against specific order / (min. 3 pcs)</p>	<p>Tg XXL / Tg A</p> <p>COPRICOFANO PVC - TERMOSALDATO DASH COVER PVC - HEAT-SEALED</p> <p>COS.PEL. ref. 7007.00006 PVC - TETTO ALTO / HIGH ROOF Colore standard cod. 38 / Standard colour cod. 38</p> <p>COS.PEL. ref. 7007.00007 PVC - TETTO BASSO / LOW ROOF Colore standard cod. 38 / Standard colour cod. 38</p>
 <p>PVC : Altri colori disponibili su ordinazione / Other colour against specific order / (min. 3 pcs)</p>	<p>Tg X 2014</p> <p>COPRICOFANO CAMBIO AUTOMATICO - FRIGO DASH COVER AUTOMATIC GEARBOX - FRIDGE</p> <p>COS.PEL. ref. 7007.00026 PVC Colore standard cod. 38 / Standard colour cod. 38</p> <p>COS.PEL. ref. 7007.00027 MOQUETTES / CARPETED Colore unico cod. 41 / One colour only cod. 41</p>
 <p>Altri colori disponibili su ordinazione / Other colour against specific order / (min. 3 pcs)</p>	<p>Tg XXL / Tg A</p> <p>FODERA SEDILE - LATO GUIDA POGGIATESTA INCORPORATO</p> <p>SEAT COVER - DRIVER'S SEAT WITH BUILT-IN HEAD RESTRAINT</p> <p>COS.PEL. ref. 7007.00000</p> <p>Colore standard cod. 56 / Standard colour cod. 56</p>
 <p>Altri colori disponibili su ordinazione / Other colour against specific order / (min. 3 pcs)</p>	<p>Tg XXL / Tg A</p> <p>FODERA SEDILE - SERIE DUE POSTI POGGIATESTA INCORPORATI</p> <p>SEAT COVERS - TWO SEATS SERIES WITH BUILT-IN HEAD RESTRAINT</p> <p>COS.PEL. ref. 7007.00001</p> <p>Colore standard cod. 56 / Standard colour cod. 56</p>
 <p>PVC : Altri colori disponibili su ordinazione / Other colour against specific order / (min. 3 pcs)</p>	<p>Tg XXL / Tg A</p> <p>TAPPETO FLOOR MAT</p> <p>COS.PEL. ref. 7007.00004 PVC Colore standard cod. 38 / Standard colour cod. 38</p> <p>COS.PEL. ref. 7007.00005 MOQUETTES / CARPETED Colore unico cod. 41 / One colour only cod. 41</p>
 <p>PVC : Altri colori disponibili su ordinazione / Other colour against specific order / (min. 3 pcs)</p>	<p>Tg XXL / Tg A</p> <p>COPRICOFANO PVC - TERMOSALDATO DASH COVER PVC - HEAT-SEALED</p> <p>COS.PEL. ref. 7007.00006 PVC - TETTO ALTO / HIGH ROOF Colore standard cod. 38 / Standard colour cod. 38</p> <p>COS.PEL. ref. 7007.00007 PVC - TETTO BASSO / LOW ROOF Colore standard cod. 38 / Standard colour cod. 38</p>

 <p>Altri colori disponibili su ordinazione / Other colour against specific order / (min. 3 pcs)</p>	<p>Scudo 2014</p> <p>FODERA SEDILE - LATO GUIDA CON POGGIATESTA</p> <p>SEAT COVER - DRIVER'S SEAT WITH HEAD RESTRAINT</p> <p>COS.PEL. ref. 7010.00014</p> <p>Colore standard cod. 56 / Standard colour cod. 56</p>
 <p>Altri colori disponibili su ordinazione / Other colour against specific order / (min. 3 pcs)</p>	<p>Scudo 2014</p> <p>FODERA SEDILE - SERIE TRE POSTI SEDILE GUIDA - PANCHETTA CON CINTURA E POGGIATESTA E CERNIERA PORTAOGGETTI</p> <p>SEAT COVERS - THREE SEATS SERIES DRIVER'S SEAT - BENCH SEAT WITH SAFETY BELT AND HEAD RESTRAINT AND ZIP FOR GLOVE COMPARTMENT</p> <p>COS.PEL. ref. 7010.00015</p> <p>Colore standard cod. 56 / Standard colour cod. 56</p>
 <p>PVC : Altri colori disponibili su ordinazione / Other colour against specific order / (min. 3 pcs)</p>	<p>Scudo 2014</p> <p>TAPPETO FLOOR MAT</p> <p>COS.PEL. ref. 7010.00016 PVC Colore standard cod. 38 / Standard colour cod. 38</p> <p>COS.PEL. ref. 7010.00017 MOQUETTES / CARPETED Colore unico cod. 41 / One colour only cod. 41</p>
 <p>Altri colori disponibili su ordinazione / Other colour against specific order / (min. 3 pcs)</p>	<p>Doblo' 2014</p> <p>FODERA SEDILE - SERIE DUE POSTI SEDILI SINGOLI CON POGGIATESTA</p> <p>SEAT COVERS - TWO SEATS SERIES SINGLE SEATS WITH HEAD RESTRAINT</p> <p>COS.PEL. ref. 7010.00020</p> <p>Colore standard cod. 56 / Standard colour cod. 56</p>
 <p>PVC : Altri colori disponibili su ordinazione / Other colour against specific order / (min. 3 pcs)</p>	<p>Dobl 2015</p> <p>TAPPETO FLOOR MAT</p> <p>COS.PEL. ref. 7010.00021 PVC Colore standard cod. 38 / Standard colour cod. 38</p>
 <p>Altri colori disponibili su ordinazione / Other colour against specific order / (min. 3 pcs)</p>	<p>Scudo 2007</p> <p>FODERA SEDILE - LATO GUIDA CON POGGIATESTA</p> <p>SEAT COVER - DRIVER'S SEAT WITH HEAD RESTRAINT</p> <p>COS.PEL. ref. 7010.00012</p> <p>Colore standard cod. 56 / Standard colour cod. 56</p>
 <p>Altri colori disponibili su ordinazione / Other colour against specific order / (min. 3 pcs)</p>	<p>Scudo 2007</p> <p>FODERA SEDILE - SERIE TRE POSTI SEDILE GUIDA - PANCHETTA CON CINTURA E POGGIATESTA E CERNIERA PORTAOGGETTI</p> <p>SEAT COVERS - THREE SEATS SERIES DRIVER'S SEAT - BENCH SEAT WITH SAFETY BELT HEAD RESTRAINT AND ZIP FOR GLOVE COMPARTMENT</p> <p>COS.PEL. ref. 7010.00013</p> <p>Colore standard cod. 56 / Standard colour cod. 56</p>
 <p>Altri colori disponibili su ordinazione / Other colour against specific order / (min. 3 pcs)</p>	<p>Doblo' 2010</p> <p>FODERA SEDILE - SERIE DUE POSTI SEDILI SINGOLI CON POGGIATESTA</p> <p>SEAT COVERS - TWO SEATS SERIES SINGLE SEATS WITH HEAD RESTRAINT</p> <p>COS.PEL. ref. 7010.00018</p> <p>Colore standard cod. 56 / Standard colour cod. 56</p>

PARTI DI RICAMBIO ADATTABILI A : **COS.FIA**
 SPARE PARTS SUITABLE TO :

 <p>Altri colori disponibili su ordinazione / Other colour against specific order / (min. 3 pcs)</p>	<p>Doblo' 2010</p> <p>FODERA SEDILE - SERIE TRE POSTI PANCHETTA POSTERIORE</p> <p>SEAT COVERS - THREE SEATS SERIES REAR BENCH</p> <p>COS.PEL. ref. 7010.00019</p> <p>Colore standard cod. 56 / Standard colour cod. 56</p>
 <p>Altri colori disponibili su ordinazione / Other colour against specific order / (min. 3 pcs)</p>	<p>Ducato 2014</p> <p>FODERA SEDILE - LATO GUIDA CON POGGIATESTA</p> <p>SEAT COVER - DRIVER'S SEAT WITH HEAD RESTRAINT</p> <p>COS.PEL. ref. 7010.00007</p> <p>Colore standard cod. 56 / Standard colour cod. 56</p>
 <p>Altri colori disponibili su ordinazione / Other colour against specific order / (min. 3 pcs)</p>	<p>Ducato 2014</p> <p>FODERA SEDILE - SERIE TRE POSTI SEDILE GUIDA - PANCHETTA CON CINTURA E POGGIATESTA</p> <p>SEAT COVERS - THREE SEATS SERIES DRIVER'S SEAT - BENCH SEAT WITH SAFETY-BELTS AND HEAD RESTRAINT</p> <p>COS.PEL. ref. 7010.00008</p> <p>Colore standard cod. 56 / Standard colour cod. 56</p>
 <p>Altri colori disponibili su ordinazione / Other colour against specific order / (min. 3 pcs)</p>	<p>Ducato 2014</p> <p>FODERA SEDILE - SERIE SEI+UNO POSTI SEDILE GUIDA - PANCHETTA E SEDILE 4 POSTI</p> <p>SEAT COVERS - SIX+ONE SEATS SERIES DRIVER'S SEAT - BENCH SEAT AND 4 PLACE SEATS</p> <p>COS.PEL. ref. 7010.00009</p> <p>Colore standard cod. 56 / Standard colour cod. 56</p>
 <p>PVC : Altri colori disponibili su ordinazione / Other colour against specific order / (min. 3 pcs)</p>	<p>Ducato 2014</p> <p>TAPPETO FLOOR MAT</p> <p>COS.PEL. ref. 7010.00010 PVC Colore standard cod. 38 / Standard colour cod. 38</p> <p>COS.PEL. ref. 7010.00011 MOQUETTES / CARPETED Colore unico cod. 41 / One colour only cod. 41</p>
 <p>Altri colori disponibili su ordinazione / Other colour against specific order / (min. 3 pcs)</p>	<p>Ducato 2007</p> <p>FODERA SEDILE - LATO GUIDA CON POGGIATESTA</p> <p>SEAT COVER - DRIVER'S SEAT WITH HEAD RESTRAINT</p> <p>COS.PEL. ref. 7010.00000</p> <p>Colore standard cod. 56 / Standard colour cod. 56</p>
 <p>Altri colori disponibili su ordinazione / Other colour against specific order / (min. 3 pcs)</p>	<p>Ducato 2007</p> <p>FODERA SEDILE - SERIE TRE POSTI SEDILE GUIDA - PANCHETTA CON CINTURA E POGGIATESTA</p> <p>SEAT COVERS - THREE SEATS SERIES DRIVER'S SEAT - BENCH SEAT WITH SAFETY-BELTS AND HEAD RESTRAINT</p> <p>COS.PEL. ref. 7010.00001</p> <p>Colore standard cod. 56 / Standard colour cod. 56</p>
 <p>Altri colori disponibili su ordinazione / Other colour against specific order / (min. 3 pcs)</p>	<p>Ducato 2007</p> <p>FODERA SEDILE - SERIE SEI+UNO POSTI SEDILE GUIDA - PANCHETTA E SEDILE 4 POSTI</p> <p>SEAT COVERS - SIX+ONE SEATS SERIES DRIVER'S SEAT - BENCH SEAT AND 4 PLACE SEATS</p> <p>COS.PEL. ref. 7010.00002</p> <p>Colore standard cod. 56 / Standard colour cod. 56</p>

 <p>PVC : Altri colori disponibili su ordinazione / Other colour against specific order / (min. 3 pcs)</p>	<p>Ducato 2007</p> <p>TAPPETO FLOOR MAT</p> <p>COS.PEL. ref. 7010.00003 PVC Colore standard cod. 38 / Standard colour cod. 38</p> <p>COS.PEL. ref. 7010.00004 MOQUETTES / CARPETED Colore unico cod. 41 / One colour only cod. 41</p>
 <p>PVC : Altri colori disponibili su ordinazione / Other colour against specific order / (min. 3 pcs)</p>	<p>Ducato 2010</p> <p>TAPPETO FLOOR MAT</p> <p>COS.PEL. ref. 7010.00005 PVC Colore standard cod. 38 / Standard colour cod. 38</p> <p>COS.PEL. ref. 7010.00006 MOQUETTES / CARPETED Colore unico cod. 41 / One colour only cod. 41</p>



FODERE / COVERS

**COLORI DISPONIBILI /
AVAILABLE COLORS :**

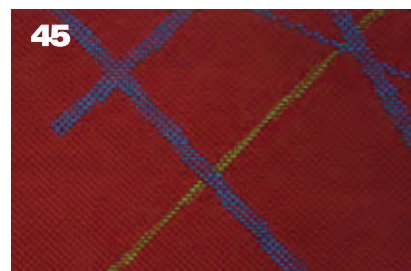
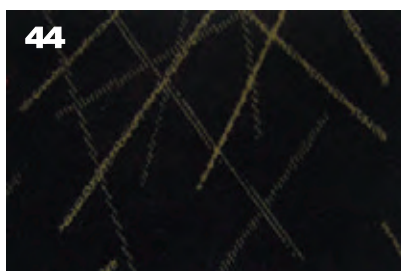
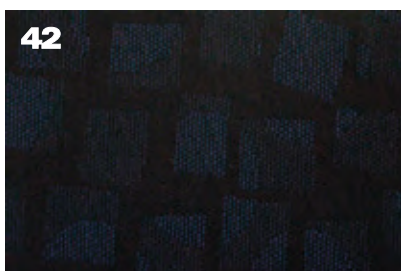
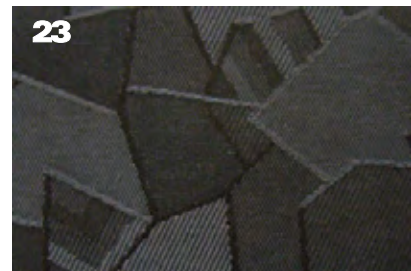
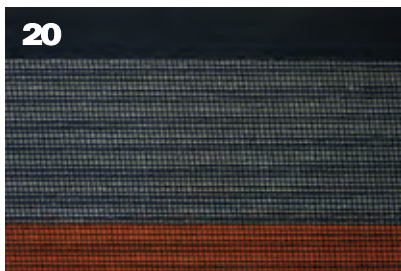
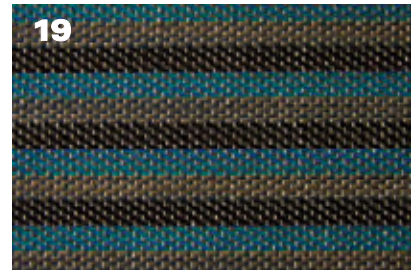
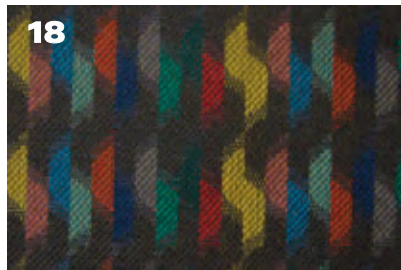
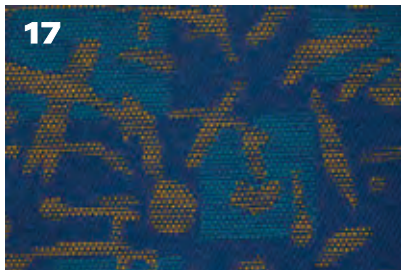
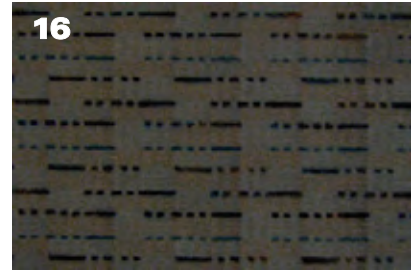
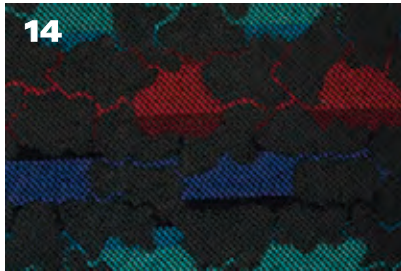
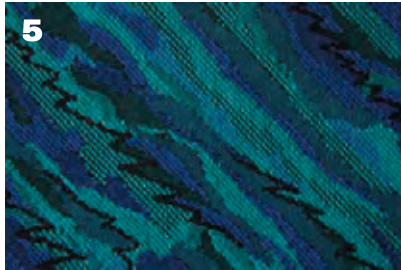

Fodere/Copricofani/Tappeti Covers



Colori disponibili / Available colours



47



49



50

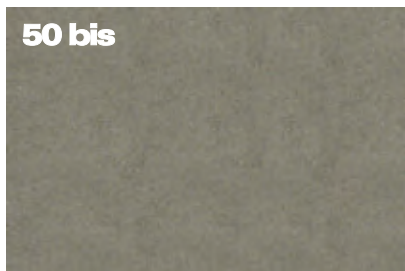

50 bis



51

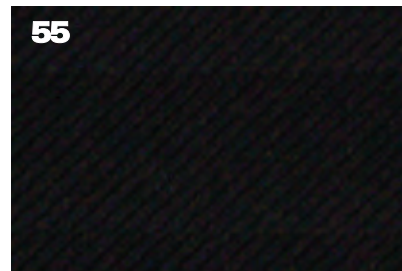

55

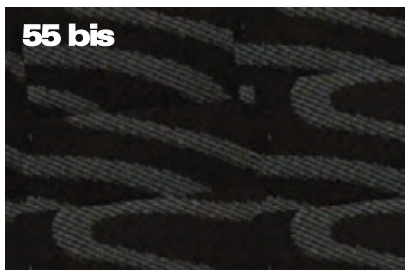

55 bis

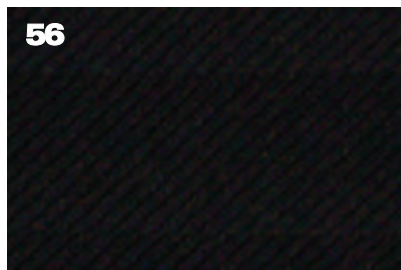

56

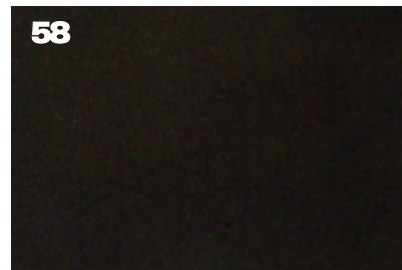

58

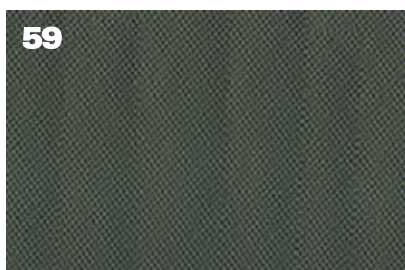

59

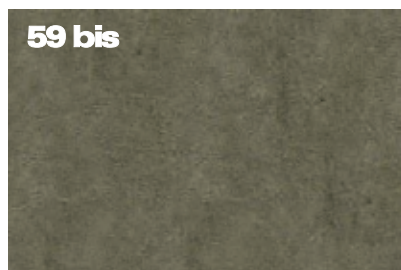

59 bis

**COPRICOFANI - TAPPETI /
DASH MATS - FLOOR MATS**

PVC

**COLORI DISPONIBILI /
AVAILABLE COLORS :**

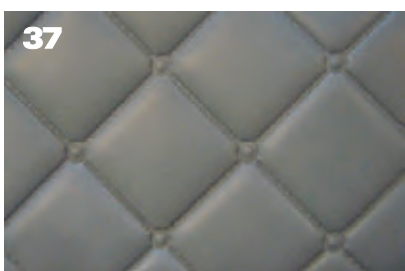

37

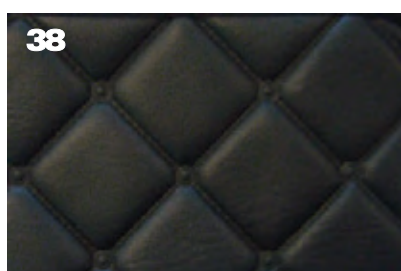

38



39

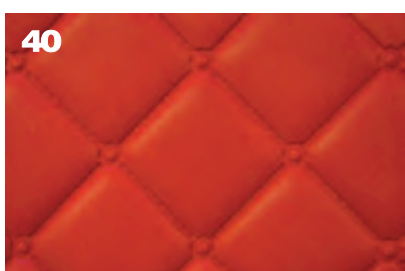

40

**COPRICOFANI - TAPPETI /
DASH MATS - FLOOR MATS**

**MOQUETTES /
CARPETED**

**COLORI DISPONIBILI /
AVAILABLE COLORS :**

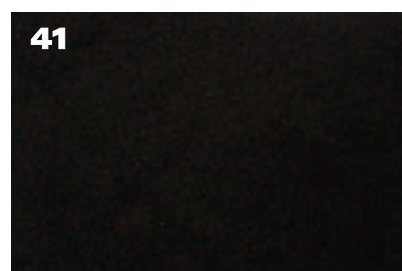

41





Parti di ricambio adattabili a:
Spare parts suitable to:



Esempio di montaggio (rif. 2200.00000)

	<p>Prodotti per la sicurezza / Security products</p> <p>KIT TELECAMERA SENZA FILI 12/24V - MULTI SCHERMI 7" - REGISTR.TEMPO REALE - SUPP.MICRO SD - VISIONE NOTT. - MICROF. WIRELESS CAMERA KIT 12/24V - MULTI SCREENS 7 INCHES</p> <p>COS.PEL. ref. 2200.00000</p>
	<p>Prodotti per la sicurezza / Security products</p> <p>KIT TELECAMERA SENZA FILI 12/24V - MULTI SCHERMI 7" - REGISTR.TEMPO REALE - SUPP.MICRO SD - VISIONE NOTT. - MICROF. WIRELESS CAMERA KIT 12/24V - MULTI SCREENS 7 INCHES</p> <p>COS.PEL. ref. 2200.00001</p>
	<p>Prodotti per la sicurezza / Security products</p> <p>SCHERMO PER KIT TELECAMERA 12/24V - 7" SCREEN FOR CAMERA KIT 12/24V - 7"</p> <p>COS.PEL. ref. 2200.00002</p>
	<p>Prodotti per la sicurezza / Security products</p> <p>TELECAMERA PER KIT 12/24V CAMERA FOR KIT 12/24V</p> <p>COS.PEL. ref. 2200.00003</p>

	<p>Spazzole tergicristalli / Wiper blades</p> <p>ESPOSITORE SPAZZOLE TERGI CON SPAZZOLE Composizione : 8000.00001/2 X 8 - 3/4 x 6 + 5/6/7/8 x 4 + Esibitore EXIBITOR WITH WIPER BLADES Composition : 8000.00001/2 X 8 - 3/4 x 6 + 5/6/7/8 x 4 + Exhibitor</p> <p>COS.PEL. ref. 8000.00000</p>
	<p>Spazzole tergicristalli / Wiper blades</p> <p>SPAZZOLA TERGI UNIVERSALE 35,50 cm 35,50cm UNIVERSAL WIPER BLADE 35,50cm (14") 35,50cm (14")</p> <p>COS.PEL. ref. 8000.00001</p>
	<p>Spazzole tergicristalli / Wiper blades</p> <p>SPAZZOLA TERGI UNIVERSALE 40,60cm 40,60cm UNIVERSAL WIPER BLADE 40,60cm (16") 40,60cm (16")</p> <p>COS.PEL. ref. 8000.00002</p>
	<p>Spazzole tergicristalli / Wiper blades</p> <p>SPAZZOLA TERGI UNIVERSALE 45,50cm 45,50cm UNIVERSAL WIPER BLADE 45,50cm (18") 45,50cm (18")</p> <p>COS.PEL. ref. 8000.00003</p>
	<p>Spazzole tergicristalli / Wiper blades</p> <p>SPAZZOLA TERGI UNIVERSALE 50,00cm 50,00cm UNIVERSAL WIPER BLADE 50,00cm (20") 50,00cm (20")</p> <p>COS.PEL. ref. 8000.00004</p>
	<p>Spazzole tergicristalli / Wiper blades</p> <p>SPAZZOLA TERGI UNIVERSALE 55,00cm 55,00cm UNIVERSAL WIPER BLADE 55,00cm (22") 55,00cm (22")</p> <p>COS.PEL. ref. 8000.00005</p>
	<p>Spazzole tergicristalli / Wiper blades</p> <p>SPAZZOLA TERGI UNIVERSALE 60,00cm 60,00cm UNIVERSAL WIPER BLADE 60,00cm (24") 60,00cm (24")</p> <p>COS.PEL. ref. 8000.00006</p>
	<p>Spazzole tergicristalli / Wiper blades</p> <p>SPAZZOLA TERGI UNIVERSALE 65,00cm 65,00cm UNIVERSAL WIPER BLADE 65,00cm (26") 65,00cm (26")</p> <p>COS.PEL. ref. 8000.00007</p>

	<p>Spazzole tergicristalli / Wiper blades</p> <p>SPAZZOLA TERGI UNIVERSALE 70,00cm 70,00cm UNIVERSAL WIPER BLADE 70,00cm (28") 70,00cm (28")</p> <p>COS.PEL. ref. 8000.00008</p>
	<p>Spazzole tergicristalli / Wiper blades</p> <p>SPAZZOLA TERGI UNIVERSALE 60,00cm CON SPRUZZATORE 60,00cm UNIVERSAL WIPER BLADE 60,00cm (24") WITH SPRINKLER 60,00cm (24")</p> <p>COS.PEL. ref. 8000.00009</p>
	<p>Spazzole tergicristalli / Wiper blades</p> <p>SPAZZOLA TERGI UNIVERSALE 65,00cm CON SPRUZZATORE 65,00cm UNIVERSAL WIPER BLADE 65,00cm (26") WITH SPRINKLER 65,00cm (26")</p> <p>COS.PEL. ref. 8000.00010</p>
	<p>Spazzole tergicristalli / Wiper blades</p> <p>SPAZZOLA TERGI UNIVERSALE 70,00cm CON SPRUZZATORE 70,00cm UNIVERSAL WIPER BLADE 70,00cm (28") WITH SPRINKLER 70,00cm (28")</p> <p>COS.PEL. ref. 8000.00011</p>





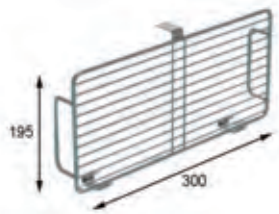
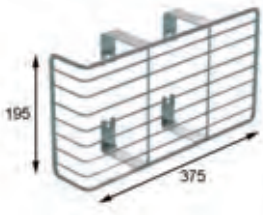
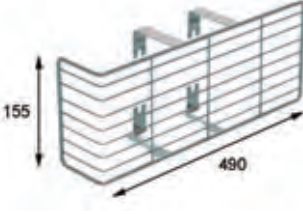
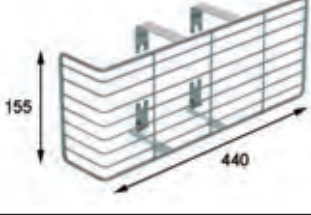
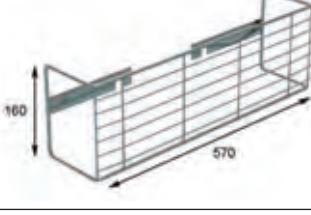
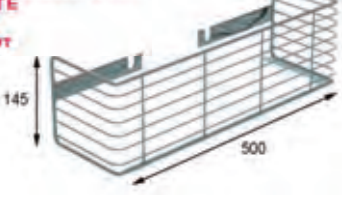
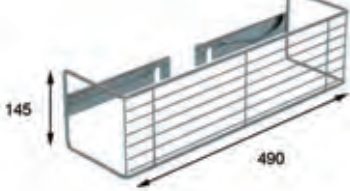



Tappi antifurto gasolio / Thief-proof gasoil plug

	<p>Tappi antifurto gasolio / Thief-proof gasoil plug</p> <p>TAPPO ANTIFURTO GASOLIO - DIAMETRO 105 DIAMETRO 105 THIEF-PROOF GASOIL PLUG - DIAMETER 105 DIAMETER 105</p> <p>COS.PEL. ref. 2000.00000</p>
	<p>Tappi antifurto gasolio / Thief-proof gasoil plug</p> <p>TAPPO ANTIFURTO GASOLIO - DIAMETRO 80 DIAMETRO 80 THIEF-PROOF GASOIL PLUG - DIAMETER 80 DIAMETER 80</p> <p>COS.PEL. ref. 2000.00001</p>
	<p>Tappi antifurto gasolio / Thief-proof gasoil plug</p> <p>TAPPO ANTIFURTO GASOLIO - DIAMETRO 80 DIAMETRO 80 - BAIONETTA THIEF-PROOF GASOIL BAYONET PLUG - DIAMETER 80 DIAMETER 80 - BAYONET</p> <p>COS.PEL. ref. 2000.00002</p>
	<p>Tappi antifurto gasolio / Thief-proof gasoil plug</p> <p>TAPPO ANTIFURTO GASOLIO - DIAMETRO 80 DIAMETRO 80 - FILETTO INTERNO THIEF-PROOF GASOIL PLUG 80 - DIAMETER 80 DIAMETER 80 - INSIDE THREADING</p> <p>COS.PEL. ref. 2000.00003</p>
	<p>Tappi antifurto gasolio / Thief-proof gasoil plug</p> <p>STAFFA ANTIFURTO GASOLIO Per Cos.Da Xf106 THIEF-PROOF GASOIL BRACKET For Cos.Da Xf106</p> <p>COS.PEL. ref. 2000.00004</p>

	<p>Griglie riparafanali / Protection grids</p> <p>PROTEZIONE FARO Per Cos.Ive Daily 96 GRID For Cos.Ive Daily 96 COS.PEL. ref. 2000.00010</p>
	<p>Griglie riparafanali / Protection grids</p> <p>PROTEZIONE FARO Per Cos.Ive Daily 2000 GRID For Cos.Ive Daily 2000 COS.PEL. ref. 2000.00011</p>
	<p>Griglie riparafanali / Protection grids</p> <p>PROTEZIONE FARO Per Cos.Ive Eurotech GRID For Cos.Ive Eurotech COS.PEL. ref. 2000.00012</p>
	<p>Griglie riparafanali / Protection grids</p> <p>PROTEZIONE FARO Per Cos.Me Atego/Sprinter GRID For Cos.Me Atego/Sprinter COS.PEL. ref. 2000.00013</p>
	<p>Griglie riparafanali / Protection grids</p> <p>PROTEZIONE FARO Per Cos.Me GRID For Cos.Me COS.PEL. ref. 2000.00014</p>
<p>AD ESAURIMENTO SCORTE UNTIL SELL OUT</p> 	<p>Griglie riparafanali / Protection grids</p> <p>PROTEZIONE FARO Per Cos.Vo F-M GRID For Cos.Vo F-M COS.PEL. ref. 2000.00015</p>
	<p>Griglie riparafanali / Protection grids</p> <p>GRIGLIA PROTEZIONE FARO Per Cos.Ma Tga / Cos.Re Premium-Kerax / Cos.Da Cf HEADLAMP PROTECTION CAGE For Cos.Ma Tga / Cos.Re Premium-Kerax / Cos.Da Cf COS.PEL. ref. 2000.00016</p>









  <p>Ø 27 mm</p>	<p>Copribulloni / Cover nuts</p> <p>COPRIBULLONE - DIAMETRO 27mm DIAMETRO 27mm - PLASTICA / CROMATO - A.B.S. COVER NUT - DIAMETER 27mm DIAMETER 27mm - PLASTIC / CHROMED - A.B.S.</p> <p>COS.PEL. ref. 2000.00130 Ordinabile solo per conf. di 20 pz. / Sold by package of 20 pcs.</p>
<p>AD ESAURIMENTO SCORTE UNTIL SELL-OUT</p>   <p>Ø 27 mm</p>	<p>Copribulloni / Cover nuts</p> <p>COPRIBULLONE - DIAMETRO 27mm DIAMETRO 27mm - PLASTICA / NERO - A.B.S. COVER NUT - DIAMETER 27mm DIAMETER 27mm - PLASTIC / BLACK - A.B.S.</p> <p>COS.PEL. ref. 2000.00131 Ordinabile solo per conf. di 20 pz. / Sold by package of 20 pcs.</p>
  <p>Ø 30 mm</p>	<p>Copribulloni / Cover nuts</p> <p>COPRIBULLONE - DIAMETRO 30mm DIAMETRO 30mm - PLASTICA / CROMATO - A.B.S. COVER NUT - DIAMETER 30mm DIAMETER 30mm - PLASTIC / CHROMED - A.B.S.</p> <p>COS.PEL. ref. 2000.00132 Ordinabile solo per conf. di 20 pz. / Sold by package of 20 pcs.</p>
  <p>Ø 32 mm</p>	<p>Copribulloni / Cover nuts</p> <p>COPRIBULLONE - DIAMETRO 32mm DIAMETRO 32mm - PLASTICA / CROMATO - A.B.S. COVER NUT - DIAMETER 32mm DIAMETER 32mm - PLASTIC / CHROMED - A.B.S.</p> <p>COS.PEL. ref. 2000.00135 Ordinabile solo per conf. di 20 pz. / Sold by package of 20 pcs.</p>
  <p>Ø 33 mm</p>	<p>Copribulloni / Cover nuts</p> <p>COPRIBULLONE - DIAMETRO 33mm DIAMETRO 33mm - ACCIAIO INOX COVER NUT - DIAMETER 33mm DIAMETER 33mm - STAINLESS STEEL</p> <p>COS.PEL. ref. 2000.00144 Ordinabile solo per conf. di 20 pz. / Sold by package of 20 pcs.</p>
  <p>Ø 33 mm</p>	<p>Copribulloni / Cover nuts</p> <p>COPRIBULLONE - DIAMETRO 33mm DIAMETRO 33mm - PLASTICA / CROMATO COVER NUT - DIAMETER 33mm DIAMETER 33mm - PLASTIC / CHROMED</p> <p>COS.PEL. ref. 2000.00145 Ordinabile solo per conf. di 20 pz. / Sold by package of 20 pcs.</p>
<p>AD ESAURIMENTO SCORTE UNTIL SELL-OUT</p>   <p>Ø 33 mm</p>	<p>Copribulloni / Cover nuts</p> <p>COPRIBULLONE - DIAMETRO 33mm DIAMETRO 33mm - H55 - GRIGIO - A.B.S. COVER NUT - DIAMETER 33mm DIAMETER 33mm - H55 - GREY - A.B.S.</p> <p>COS.PEL. ref. 2000.00149 Ordinabile solo per conf. di 20 pz. / Sold by package of 20 pcs.</p>
<p>AD ESAURIMENTO SCORTE UNTIL SELL-OUT</p>   <p>Ø 33 mm</p>	<p>Copribulloni / Cover nuts</p> <p>COPRIBULLONE - DIAMETRO 33mm DIAMETRO 33mm - H55 - NERO - A.B.S. COVER NUT - DIAMETER 33mm DIAMETER 33mm - H55 - BLACK - A.B.S.</p> <p>COS.PEL. ref. 2000.00150 Ordinabile solo per conf. di 20 pz. / Sold by package of 20 pcs.</p>

	<p>Copribulloni / Cover nuts</p> <p>COPRIBULLONE - CHIAVE 32 A.B.S. - PLASTICA / CROMATO COVER NUT - KEY 32 A.B.S. - PLASTIC / CHROMED</p> <p>COS.PEL. ref. 2000.00151 Ordinabile solo per conf. di 20 pz. / Sold by package of 20 pcs.</p>
	<p>Copribulloni / Cover nuts</p> <p>COPRIBULLONE - CHIAVE 33 A.B.S. - PLASTICA / CROMATO COVER NUT - KEY 33 A.B.S. - PLASTIC / CHROMED</p> <p>COS.PEL. ref. 2000.00152 Ordinabile solo per conf. di 20 pz. / Sold by package of 20 pcs.</p>
	<p>Copribulloni / Cover nuts</p> <p>COPRIBULLONE - CHIAVE 32 A.B.S. - NERO COVER NUT - KEY 32 A.B.S. - BLACK</p> <p>COS.PEL. ref. 2000.00153 Ordinabile solo per conf. di 20 pz. / Sold by package of 20 pcs.</p>
	<p>Copribulloni / Cover nuts</p> <p>COPRIBULLONE - CHIAVE 33 A.B.S. - NERO COVER NUT - KEY 33 A.B.S. - BLACK</p> <p>COS.PEL. ref. 2000.00154 Ordinabile solo per conf. di 20 pz. / Sold by package of 20 pcs.</p>

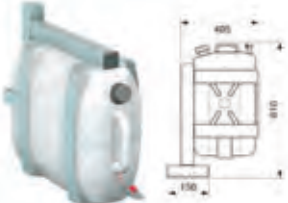
	<p>Anelli / Coppe coprimozzo / Ring wheel covers</p> <p>ANELLO COPRIMOZZO 6 FORI 6 FORI - PLASTICA GRIGIO RING WHEEL COVER 6 HOLES 6 HOLES - PLASTIC GREY</p> <p>COS.PEL. ref. 2000.00200 Ordinabile solo per conf. di 2 pz. / Sold by package of 2 pcs.</p>
<p>AD ESAURIMENTO SCORTE UNTIL SELL-OUT</p> 	<p>Anelli / Coppe coprimozzo / Ring wheel covers</p> <p>ANELLO COPRIMOZZO 6 FORI 6 FORI - ACCIAIO VERNICIATO NERO RING WHEEL COVER 6 HOLES 6 HOLES - STEEL PAINTED IN BLACK</p> <p>COS.PEL. ref. 2000.00201 Ordinabile solo per conf. di 2 pz. / Sold by package of 2 pcs.</p>
	<p>Anelli / Coppe coprimozzo / Ring wheel covers</p> <p>ANELLO COPRIMOZZO 6 FORI 6 FORI - ACCIAIO INOX RING WHEEL COVER 6 HOLES 6 HOLES - STAINLESS STEEL</p> <p>COS.PEL. ref. 2000.00202 Ordinabile solo per conf. di 2 pz. / Sold by package of 2 pcs.</p>
	<p>Anelli / Coppe coprimozzo / Ring wheel covers</p> <p>ANELLO COPRIMOZZO 6 FORI 6 HOLES RING WHEEL COVER 6 HOLES 6 HOLES</p> <p>COS.PEL. ref. 2000.00203 Ordinabile solo per conf. di 2 pz. / Sold by package of 2 pcs.</p>
	<p>Anelli / Coppe coprimozzo / Ring wheel covers</p> <p>ANELLO COPRIMOZZO 8 FORI 8 FORI - PLASTICA / GRIGIO - DIAMETRO 22mm RING WHEEL COVER 8 HOLES 8 HOLES - PLASTIC - GREY - DIAMETER 22 mm</p> <p>COS.PEL. ref. 2000.00206 Ordinabile solo per conf. di 2 pz. / Sold by package of 2 pcs.</p>
<p>AD ESAURIMENTO SCORTE UNTIL SELL-OUT</p> 	<p>Anelli / Coppe coprimozzo / Ring wheel covers</p> <p>ANELLO COPRIMOZZO 8 FORI 8 FORI - ACCIAIO VERNICIATO NERO RING WHEEL COVER 8 HOLES 8 HOLES - STEEL PAINTED IN BLACK</p> <p>COS.PEL. ref. 2000.00207 Ordinabile solo per conf. di 2 pz. / Sold by package of 2 pcs.</p>
	<p>Anelli / Coppe coprimozzo / Ring wheel covers</p> <p>ANELLO COPRIMOZZO 8 FORI 8 HOLES - ACCIAIO INOX RING WHEEL COVER 8 HOLES 8 HOLES - STAINLESS STEEL</p> <p>COS.PEL. ref. 2000.00208 Ordinabile solo per conf. di 2 pz. / Sold by package of 2 pcs.</p>
	<p>Anelli / Coppe coprimozzo / Ring wheel covers</p> <p>ANELLO COPRIMOZZO 10 FORI 10 FORI - PLASTICA - GRIGIO - DIAMETRO 22mm RING WHEEL COVER 10 HOLES 10 HOLES - PLASTIC - GREY - DIAMETER 22mm</p> <p>COS.PEL. ref. 2000.00211 Ordinabile solo per conf. di 2 pz. / Sold by package of 2 pcs.</p>

Anelli / Coppe coprimozzo / Ring wheel covers

	<p>Anelli / Coppe coprimozzo / Ring wheel covers</p> <p>ANELLO COPRIMOZZO 10 FORI 10 FORI - PLASTICA - GRIGIO - DIAMETRO 32mm RING WHEEL COVER 10 HOLES 10 FORI - PLASTIC - GREY - DIAMETER 32mm</p> <p>COS.PEL. ref. 2000.00213 Ordinabile solo per conf. di 2 pz. / Sold by package of 2 pcs.</p>
	<p>Anelli / Coppe coprimozzo / Ring wheel covers</p> <p>ANELLO COPRIMOZZO 10 FORI 10 FORI - ACCIAIO - NERO RING WHEEL COVER 10 HOLES 10 HOLES - STAINLESS STEEL - BLACK</p> <p>COS.PEL. ref. 2000.00215 Ordinabile solo per conf. di 2 pz. / Sold by package of 2 pcs.</p>
	<p>Anelli / Coppe coprimozzo / Ring wheel covers</p> <p>ANELLO COPRIMOZZO 10 FORI 10 FORI - ACCIAIO INOX RING WHEEL COVER 10 HOLES 10 HOLES - STAINLESS STEEL</p> <p>COS.PEL. ref. 2000.00216 Ordinabile solo per conf. di 2 pz. / Sold by package of 2 pcs.</p>
	<p>Anelli / Coppe coprimozzo / Ring wheel covers</p> <p>COPPA COPRIMOZZO 8 FORI 8 FORI - ACCIAIO INOX RING WHEEL COVER 8 HOLES 8 HOLES - STAINLESS STEEL</p> <p>COS.PEL. ref. 2000.00249 Ordinabile solo per conf. di 2 pz. / Sold by package of 2 pcs.</p>
	<p>Anelli / Coppe coprimozzo / Ring wheel covers</p> <p>COPPA COPRIMOZZO 6 FORI 6 FORI - PLASTICA - GRIGIO RING WHEEL COVER 6 HOLES 6 HOLES - PLASTIC - GREY</p> <p>COS.PEL. ref. 2000.00250 Ordinabile solo per conf. di 2 pz. / Sold by package of 2 pcs.</p>
	<p>Anelli / Coppe coprimozzo / Ring wheel covers</p> <p>COPPA COPRIMOZZO 6 FORI 6 HOLES - ACCIAIO INOX WHEEL COVER 6 HOLES 6 HOLES - STAINLESS STEEL</p> <p>COS.PEL. ref. 2000.00251 Ordinabile solo per conf. di 2 pz. / Sold by package of 2 pcs.</p>
	<p>Anelli / Coppe coprimozzo / Ring wheel covers</p> <p>COPPA COPRIMOZZO 10 FORI 10 FORI - ACCIAIO INOX WHEEL COVER 10 HOLES 10 HOLES - STAINLESS STEEL</p> <p>COS.PEL. ref. 2000.00252 Ordinabile solo per conf. di 2 pz. / Sold by package of 2 pcs.</p>
<p>AD ESAURIMENTO SCORTE UNTIL SELL-OUT</p> 	<p>Anelli / Coppe coprimozzo / Ring wheel covers</p> <p>COPPA COPRIMOZZO 10 FORI 10 FORI - C/LEGA INOX WHEEL COVER INOX 10 HOLES 10 HOLES - STAINLESS STEEL</p> <p>COS.PEL. ref. 2000.00256 Ordinabile solo per conf. di 2 pz. / Sold by package of 2 pcs.</p>

	<p>Taniche acqua / Water tanks</p> <p>SUPPORTO PER TANICA PLASTICA 25 LT. 25 LT. TANK SUPPORT 25 LT. 25 LT.</p> <p>COS.PEL. ref. 6000.00009</p>
	<p>Taniche acqua / Water tanks</p> <p>TANICA IN PLASTICA 25 LT. P.V.C. TANK 25 LT. P.V.C.</p> <p>COS.PEL. ref. 6000.00010</p>
	<p>Taniche acqua / Water tanks</p> <p>TANICA PLASTICA CON SUPPORTO ZINCATO 25 LT. P.V.C. 25 LITER TANK WITH GALVANIZED SUPPORT P.V.C.</p> <p>COS.PEL. ref. 6000.00011</p>
	<p>Taniche acqua / Water tanks</p> <p>TANICA 12 LT. INOX FORETTATO TANK 12 LT. ANTI-REFLEX STAINLESS STEEL</p> <p>COS.PEL. ref. 6000.00012</p>
	<p>Taniche acqua / Water tanks</p> <p>TANICA 25 LT. MOTRICE INOX FIORETTATO - PER MOTRICE TANK 25 LT. FOR TRACTOR ANTI-REFLEX STAINLESS STEEL - FOR TRACTOR</p> <p>COS.PEL. ref. 6000.00013</p>
	<p>Taniche acqua / Water tanks</p> <p>TANICA 25 LT. PER MOTRICE INOX FIORETTATO - PER MOTRICE TANK 25 LT. FOR TRACTOR ANTI-REFLEX STAINLESS STEEL - FOR TRACTOR</p> <p>COS.PEL. ref. 6000.00014</p>
	<p>Taniche acqua / Water tanks</p> <p>TANICA 25 LT. INOX FIORETTATO - PER COS.DA TANK 25 LT. ANTI-REFLEX STAINLESS STEEL - FOR COS.DA</p> <p>COS.PEL. ref. 6000.00015</p>
	<p>Taniche acqua / Water tanks</p> <p>TANICA 16 LT. INOX FIORETTATO - PER COS.ME ACTROS TANK 16 LT. ANTI-REFLEX STAINLESS STEEL - FOR COS.ME ACTROS</p> <p>COS.PEL. ref. 6000.00016</p>

Taniche acqua / Water tanks









	<p>Taniche acqua / Water tanks</p> <p>TAPPO PER TANICA PLASTICA COVER FOR TANK</p> <p>COS.PEL. ref. 6000.00017</p>
	<p>Taniche acqua / Water tanks</p> <p>TANICA 17 LT. INOX FIORETTATO - PER COS.DA TANK 17 LT. ANTI-REFLEX STAINLESS STEEL - FOR COS.DA</p> <p>COS.PEL. ref. 6000.00018</p>
	<p>Taniche acqua / Water tanks</p> <p>TANICA INOX FIORETTATO PER COS.DA XF 106 ANTI-REFLEX STAINLESS STEEL FOR COS.DA XF 106</p> <p>COS.PEL. ref. 6000.00019</p>
	<p>Taniche acqua / Water tanks</p> <p>PORTASAPONE SOAP DISPENSER</p> <p>COS.PEL. ref. 6000.00030</p>

	<p>RE Kerax/RE Nuovo Premium</p> <p>VASCHETTA ESPANSIONE</p> <p>EXPANSION TANK</p> <p>COS.PEL. ref. 2101.30080 SIMILAR ref. 7485132205</p>
	<p>VO F-M vers.2/VO F-H/VO F-H vers.2</p> <p>VASCHETTA ESPANSIONE</p> <p>EXPANSION TANK</p> <p>COS.PEL. ref. 2102.13080 SIMILAR ref. 1676400 / 1676576</p>
	<p>VO F-M vers.2/VO F-H/VO F-H vers.2</p> <p>VASCHETTA ESPANSIONE</p> <p>EXPANSION TANK</p> <p>COS.PEL. ref. 2102.64080 SIMILAR ref. 1674918</p>
	<p>SCA CR 114-124-144-164</p> <p>VASCHETTA ESPANSIONE</p> <p>EXPANSION TANK</p> <p>COS.PEL. ref. 2103.44080 SIMILAR ref. 1370707 / 1385966 / 1421090 / 1511775 / 1765735 / 1855164 / 1894478</p>
	<p>DA CF</p> <p>VASCHETTA ESPANSIONE</p> <p>EXPANSION TANK</p> <p>COS.PEL. ref. 2104.85080 SIMILAR ref. 1371329 / 1660859 / 1871493</p>
	<p>DA XF 95 1aSerie XF 95 2aSerie</p> <p>VASCHETTA ESPANSIONE</p> <p>EXPANSION TANK</p> <p>COS.PEL. ref. 2104.95080 SIMILAR ref. 0393391 / 1295910 / 1607794</p>
	<p>ME Axor</p> <p>VASCHETTA ESPANSIONE</p> <p>EXPANSION TANK</p> <p>COS.PEL. ref. 2105.94080 SIMILAR ref. A9405010003</p>
	<p>ME ActrosMP2/MegaSpaceMP2</p> <p>VASCHETTA ESPANSIONE</p> <p>EXPANSION TANK</p> <p>COS.PEL. ref. 2105.94180 SIMILAR ref. 9100002004 / A0005003149</p>

<p>AD ESAURIMENTO SCORTE UNTIL SELL-OUT</p> 	<p>ME ActrosMP2/MegaSpaceMP2</p> <p>VASCHETTA ESPANSIONE EXPANSION TANK</p> <p>COS.PEL. ref. 2105.94181 SIMILAR ref. A0005003049 / A0005003449 / A0005003849</p>
<p>AD ESAURIMENTO SCORTE UNTIL SELL-OUT</p> 	<p>IVE Daily 2014</p> <p>VASCHETTA ESPANSIONE EXPANSION TANK</p> <p>COS.PEL. ref. 2106.40080 SIMILAR ref. 504359964</p>
	<p>IVE Eurotech/IVE Eurostar</p> <p>SERBATOIO LAVACRISTALLI TANK</p> <p>COS.PEL. ref. 2106.43080 SIMILAR ref. 98409491</p>
	<p>IVE Eurotraker</p> <p>VASCHETTA ESPANSIONE EXPANSION TANK</p> <p>COS.PEL. ref. 2106.43081 SIMILAR ref. 8166285</p>
<p>AD ESAURIMENTO SCORTE UNTIL SELL-OUT</p> 	<p>IVE Eurocargo 2009 120e21/180e28</p> <p>VASCHETTA ESPANSIONE EXPANSION TANK</p> <p>COS.PEL. ref. 2106.70080 SIMILAR ref. 98426669</p>
<p>AD ESAURIMENTO SCORTE UNTIL SELL-OUT</p> 	<p>IVE Stralis AD/AT/IVE Stralis AS/IVE Nuovo Stralis 2007 AD - AT/IVE Nuovo Stralis 2007 AS</p> <p>VASCHETTA ESPANSIONE EXPANSION TANK</p> <p>COS.PEL. ref. 2106.80080 SIMILAR ref. 41215631</p>
	<p>IVE Stralis 2013 HI-WAY - AS</p> <p>VASCHETTA ESPANSIONE EXPANSION TANK</p> <p>COS.PEL. ref. 2106.92080 SIMILAR ref. 41215632</p>
	<p>MA F 2000</p> <p>VASCHETTA ESPANSIONE EXPANSION TANK</p> <p>COS.PEL. ref. 2107.02080 SIMILAR ref. 81061026098 / 81061026099 / 81061026201 / 81061026202 / 81061026218</p>









	<p>MA F 2000</p> <p>VASCHETTA ESPANSIONE</p> <p>EXPANSION TANK</p> <p>COS.PEL. ref. 2107.02081 SIMILAR ref. 81061026110 / 81061026112 / 81061026205 / 81061026209</p>
	<p>MA F 2000/MA TGA LX/MA TGA XL/XXL/MA TGS/MA TGX</p> <p>SERBATOIO OLIO STERZO</p> <p>EXPANSION TANK</p> <p>COS.PEL. ref. 2107.02082 SIMILAR ref. 81473016048</p>

Cassette in acciaio zincato / Galvanized steel tool boxes

	<p>Cassette in acciaio zincato / Galvanized steel tool boxes</p> <p>CASSETTA ZINCATA 40X30X30 SP 8/10 Dimensioni 400x300x300 mm - Profondita' 8/10 mm GALVANIZED STEEL TOOL BOX Size 400x300x300 mm - Depth 8/10 mm</p> <p>COS.PEL. ref. 6000.00300 Su richiesta si effettuano cassette di dimensioni diverse (min. 10 pz.)</p>
	<p>Cassette in acciaio zincato / Galvanized steel tool boxes</p> <p>CASSETTA IN ACCIAIO ZINCATO Dimensioni 500x300x400 mm - Profondita' 8/10 mm GALVANIZED STEEL TOOL BOX Size 500x300x400 mm - Depth 8/10 mm</p> <p>COS.PEL. ref. 6000.00301 Su richiesta si effettuano cassette di dimensioni diverse (min. 10 pz.)</p>
	<p>Cassette in acciaio zincato / Galvanized steel tool boxes</p> <p>CASSETTA IN ACCIAIO ZINCATO Dimensioni 600x400x500 mm - Profondita' 8/10 mm GALVANIZED STEEL TOOL BOX Size 600x400x500 mm - Depth 8/10 mm</p> <p>COS.PEL. ref. 6000.00302 Su richiesta si effettuano cassette di dimensioni diverse (min. 10 pz.)</p>
	<p>Cassette in acciaio zincato / Galvanized steel tool boxes</p> <p>CASSETTA IN ACCIAIO ZINCATO Dimensioni 800x500x600 mm - Profondita' 8/10 mm GALVANIZED STEEL TOOL BOX Size 800x500x600 mm - Depth 8/10 mm</p> <p>COS.PEL. ref. 6000.00303 Su richiesta si effettuano cassette di dimensioni diverse (min. 10 pz.)</p>
	<p>Cassette in acciaio zincato / Galvanized steel tool boxes</p> <p>CASSETTA IN ACCIAIO ZINCATO Dimensioni 1000x500x500 mm - Profondita' 8/10 mm GALVANIZED STEEL TOOL BOX Size 1000x500x500 mm - Depth 8/10 mm</p> <p>COS.PEL. ref. 6000.00304 Su richiesta si effettuano cassette di dimensioni diverse (min. 10 pz.)</p>
	<p>Cassette in acciaio zincato / Galvanized steel tool boxes</p> <p>CASSETTA IN ACCIAIO ZINCATO Dimensioni 500x300x300 mm - Profondita' 8/10 mm GALVANIZED STEEL TOOL BOX Size 500x300x300 mm - Depth 8/10 mm</p> <p>COS.PEL. ref. 6000.00305 Su richiesta si effettuano cassette di dimensioni diverse (min. 10 pz.)</p>
	<p>Cassette in acciaio zincato / Galvanized steel tool boxes</p> <p>CASSETTA IN ACCIAIO ZINCATO Dimensioni 800x400x400 mm - Profondita' 8/10 mm GALVANIZED STEEL TOOL BOX Size 800x400x400 mm - Depth 8/10 mm</p> <p>COS.PEL. ref. 6000.00306 Su richiesta si effettuano cassette di dimensioni diverse (min. 10 pz.)</p>
	<p>Cassette in acciaio zincato / Galvanized steel tool boxes</p> <p>CASSETTA IN ACCIAIO ZINCATO Dimensioni 350x350x350 mm - Profondita' 8/10 mm GALVANIZED STEEL TOOL BOX Size 350x350x350 mm - Depth 8/10 mm</p> <p>COS.PEL. ref. 6000.00307 Su richiesta si effettuano cassette di dimensioni diverse (min. 10 pz.)</p>

	<p>Cassette in acciaio zincato / Galvanized steel tool boxes</p> <p>CASSETTA IN ACCIAIO ZINCATO Dimensioni 500x350x400 mm - Profondita' 8/10 mm GALVANIZED STEEL TOOL BOX Size 500x350x400 mm - Depth 8/10 mm</p> <p>COS.PEL. ref. 6000.00308</p> <p>Su richiesta si effettuano cassette di dimensioni diverse (min. 10 pz.)</p>
---	---

Cassette in acciaio inox fiorettato / Anti-reflex stainless steel tool boxes

	<p>Cassette in acciaio inox fiorettato / Anti-reflex stainless steel tool boxes</p> <p>CASSETTA IN ACCIAIO FIORETTATO Dimensioni 400x300x300 mm - Profondita' 8/10 mm ANTI-REFLEX STAINLESS STEEL TOOL BOX Size 400x300x300 mm - Depth 8/10 mm</p> <p>COS.PEL. ref. 6000.00400 Su richiesta si effettuano cassette di dimensioni diverse (min. 10 pz.)</p>
	<p>Cassette in acciaio inox fiorettato / Anti-reflex stainless steel tool boxes</p> <p>CASSETTA IN ACCIAIO FIORETTATO Dimensioni 500x300x400 mm - Profondita' 8/10 mm ANTI-REFLEX STAINLESS STEEL TOOL BOX Size 500x300x400 mm - Depth 8/10 mm</p> <p>COS.PEL. ref. 6000.00401 Su richiesta si effettuano cassette di dimensioni diverse (min. 10 pz.)</p>
	<p>Cassette in acciaio inox fiorettato / Anti-reflex stainless steel tool boxes</p> <p>CASSETTA IN ACCIAIO FIORETTATO Dimensioni 600x400x500 mm - Profondita' 8/10 mm ANTI-REFLEX STAINLESS STEEL TOOL BOX Size 600x400x500 mm - Depth 8/10 mm</p> <p>COS.PEL. ref. 6000.00402 Su richiesta si effettuano cassette di dimensioni diverse (min. 10 pz.)</p>
	<p>Cassette in acciaio inox fiorettato / Anti-reflex stainless steel tool boxes</p> <p>CASSETTA IN ACCIAIO FIORETTATO Dimensioni 800x500x500 mm - Profondita' 8/10 mm ANTI-REFLEX STAINLESS STEEL TOOL BOX Size 800x500x500 mm - Depth 8/10 mm</p> <p>COS.PEL. ref. 6000.00403 Su richiesta si effettuano cassette di dimensioni diverse (min. 10 pz.)</p>
	<p>Cassette in acciaio inox fiorettato / Anti-reflex stainless steel tool boxes</p> <p>CASSETTA IN ACCIAIO FIORETTATO Dimensioni 1000x500x500 mm - Profondita' 8/10 mm ANTI-REFLEX STAINLESS STEEL TOOL BOX Size 1000x500x500 mm - Depth 8/10 mm</p> <p>COS.PEL. ref. 6000.00404 Su richiesta si effettuano cassette di dimensioni diverse (min. 10 pz.)</p>
	<p>Cassette in acciaio inox fiorettato / Anti-reflex stainless steel tool boxes</p> <p>CASSETTA IN ACCIAIO FIORETTATO Dimensioni 500x300x300 mm - Profondita' 8/10 mm ANTI-REFLEX STAINLESS STEEL TOOL BOX Size 500x300x300 mm - Depth 8/10 mm</p> <p>COS.PEL. ref. 6000.00405 Su richiesta si effettuano cassette di dimensioni diverse (min. 10 pz.)</p>
	<p>Cassette in acciaio inox fiorettato / Anti-reflex stainless steel tool boxes</p> <p>CASSETTA IN ACCIAIO FIORETTATO Dimensioni 800x400x400 mm - Profondita' 8/10 mm ANTI-REFLEX STAINLESS STEEL TOOL BOX Size 800x400x400 mm - Depth 8/10 mm</p> <p>COS.PEL. ref. 6000.00406 Su richiesta si effettuano cassette di dimensioni diverse (min. 10 pz.)</p>
	<p>Cassette in acciaio inox fiorettato / Anti-reflex stainless steel tool boxes</p> <p>CASSETTA IN ACCIAIO FIORETTATO Dimensioni 350x350x350 mm - Profondita' 8/10 mm ANTI-REFLEX STAINLESS STEEL TOOL BOX Size 350x350x350 mm - Depth 8/10 mm</p> <p>COS.PEL. ref. 6000.00407 Su richiesta si effettuano cassette di dimensioni diverse (min. 10 pz.)</p>

	<p>Cassette in acciaio inox fiorettato / Anti-reflex stainless steel tool boxes</p> <p>CASSETTA IN ACCIAIO FIORETTATO Dimensioni 500x350x400 mm - Profondita' 8/10 mm ANTI-REFLEX STAINLESS STEEL TOOL BOX Size 500x350x400 mm - Depth 8/10 mm</p> <p>COS.PEL. ref. 6000.00408</p> <p>Su richiesta si effettuano cassette di dimensioni diverse (min. 10 pz.)</p>
---	---

Staffe reggi cassetta rinforzate / Reinforced box support galvanized

	<p>Staffe reggi cassetta rinforzate / Reinforced box support galvanized</p> <p>STAFFA REGGI CASSETTA ZINC. RINFORZATA - 400X400 mm REINFORCED BOX SUPPORT 400X400 mm</p> <p>COS.PEL. ref. 6000.00100</p>
	<p>Staffe reggi cassetta rinforzate / Reinforced box support galvanized</p> <p>STAFFA REGGI CASSETTA ZINC. RINFORZATA - 500X500 mm REINFORCED BOX SUPPORT 500X500 mm</p> <p>COS.PEL. ref. 6000.00101</p>
	<p>Staffe reggi cassetta rinforzate / Reinforced box support galvanized</p> <p>STAFFA REGGI CASSETTA ZINC. RINFORZATA - 600X600 mm REINFORCED BOX SUPPORT 600X600 mm</p> <p>COS.PEL. ref. 6000.00102</p>
	<p>Staffe reggi cassetta rinforzate / Reinforced box support galvanized</p> <p>MANIGLIA CON CHIAVE PER CASSETTE CON 2 CHIAVI BOX HANDLE WITH 2 KEYS</p> <p>COS.PEL. ref. 6000.00103</p>

COS.RE

COS.PEL ref.	SIMILAR ref.	PAG			
FO141602	1209177	14	101.88433	7751688433	6
FO141602	8200074008	14	101.88434	7751688434	6
003001	5010306792	28	101.88435	7751688435	6
003001	7484538758	28	101.90121	7751690121	6
003003	5001862030	28	201.00000	7750350505	6
003004	-	28	201.00001	7750350504	6
003120	-	9	201.00002	8200432028	7
003120	-	14	201.00003	8200432027	7
003120	-	15	201.03100	7751475534	8
003120	-	22	201.03101	7751475533	8
003120	-	22	201.04100	7485120747	10
003120	-	49	201.04101	7485120748	10
003120	-	64	201.14950	5001856184	23
003121	-	22	201.14950	5001856184	50
003121	-	31	201.14950	5010314951	23
003122	-	31	201.14950	5010314951	50
003123	-	49	201.14950	5010314951	23
003810	8200228395	9	201.14951	5010314951	50
003811	8200228394	9	201.14951	5010314951	50
006120	5001847587	31	201.14952	5010314952	23
006121	-	31	201.14952	5010314952	50
006122	-	31	201.14952	5010314952	50
006130	5001847584	31	201.14953	5001856184	24
006131	5001847584	31	201.14953	5001856184	51
006131	5001847586	31	201.14953	5010314952	24
007910	265500023R	13	201.14953	5010314952	51
007910	7485120625	13	201.28252	5010228158	24
007911	265550023L	13	201.28253	5010228253	24
007911	7485120626	13	201.28253	5010228253	51
011111	5000296594	31	201.28254	5001842757	24
011111	5000296594	31	201.28254	5001842757	51
011111	5000296594	31	201.28254	5010228253	24
011112	-	31	201.28254	5010228253	51
101.01971	5010301971	23	201.28255	5001856195	24
101.01972	5010225061	23	201.28255	5001856195	37
101.01972	5010578522	23	201.28256	5010314953	24
101.03000	7751474717	8	201.28256	5010314953	37
101.03001	8200187234	8	201.28256	5010314953	37
101.04000	7485120759	10	201.29202	7482557008	58
101.04001	8200657209	10	201.29203	7482557005	58
101.04002	623100256R	10	201.30543	5010445634	37
101.04002	7485120742	10	201.30544	5001867497	37
101.04002	7485143226	10	201.30545	7421094389	51
101.23101	5010468582	50	201.30545	7421094457	51
101.25101	5010578630	32	201.30546	7421094390	37
101.29099	7484537795	56	201.30546	7421094390	51
101.29100	7482219461	56	201.30546	7421094390	51
101.29101	7482590340	56	201.30546	7421094390	58
101.29102	7482276014	56	201.30546	7421094457	37
101.29103	7482275869	56	201.30546	7421094457	51
101.29104	7482295644	57	201.30546	7421094457	58
101.29105	7482221093	57	201.30547	7421094389	51
101.29106	7482250945	57	201.30548	7421094390	37
101.29107	7482220048	57	201.30548	7421094390	51
101.30100	5010578248	36	201.30548	7421094390	58
101.30100	7420843793	36	201.30549	7421094393	37
101.30101	5010578246	36	201.30549	7421094393	51
101.30101	5010578534	36	201.30550	7421094392	37
101.53101	5010578888	18	201.30550	7421094392	51
101.69067	7751469067	6	201.30551	5010578401	37
			201.30552	5010578407	37
			201.32440	5001823641	24
			201.32440	5001823641	52
			201.32440	5010132441	24
			201.32440	5010132441	52
			201.32441	5010132441	24
			201.32441	5010132441	52
			201.92545	7420583442	37

201.92546	7420583447	37	301.30007	5010353003	39
201.92548	5010578754	36	301.30007	5010468635	25
202.13199	7421094387	38	301.30007	5010468635	39
202.13199	7421094387	52	301.30008	5010353004	25
202.13199	7421094457	38	301.30008	5010353004	39
202.13199	7421094457	52	301.30008	5010468636	25
202.13200	7421094387	38	301.30008	5010468636	39
202.13200	7421094387	52	301.30009	5010578378	39
202.13201	7421094394	38	301.30010	5010578878	39
202.13201	7421094394	52	301.30011	-	39
202.13201	7421094394	58	301.30012	-	39
202.13202	-	58	301.53000	5010353496	18
202.14202	7421094406	36	301.53001	5010353495	18
202.14202	7421094406	50	301.53002	5010468440	18
202.14202	7421094406	58	301.53003	5010468439	18
202.71388	7420498623	38	401.03090	8200197134	8
202.71388	7420936772	38	401.04089	7485122193	10
202.71389	7420726748	38	401.04090	62010BZ50A	11
202.71389	7420726748	52	401.04090	620220006R	11
202.71389	7420936768	38	401.04090	7485120736	11
202.71389	7420936768	52	401.04091	62010BZ51A	11
202.71390	7420726748	38	401.04091	620220007R	11
202.71390	7420726748	52	401.04091	7485120738	11
202.71390	7420936768	38	401.04092	851200001R	11
202.71390	7420936768	52	401.04093	851210001R	11
202.71391	7420936772	38	401.19006	5010219008	53
202.92544	7420583488	38	401.19008	5000938737	53
202.92544	7420583488	52	401.19008	5010491629	53
202.92544	7420771757	38	401.19009	5010219006	53
202.92544	7420771757	52	401.19010	5010574309	53
202.92547	7420721840	36	401.19011	5010574311	53
301.00001	5010225068	25	401.19012	5010468593	53
301.00001	7421304658	25	401.19012	5010544561	53
301.00002	5010225722	25	401.25090	5010225411	32
301.00002	7421304660	25	401.25090	7482584431	32
301.25240	5010225393	32	401.25091	5010301249	33
301.25241	5010225392	32	401.25091	7420980740	33
301.25242	7420870164	32	401.25092	5010628893	33
301.25243	5010367075	32	401.25092	7482491182	33
301.29100	7482574837	58	401.25811	5010225821	25
301.29101	7482574835	58	401.25812	5010225822	25
301.29102	7482282309	59	401.25813	5010225813	25
301.29103	7482275889	59	401.25815	5010225815	25
301.29104	7482275624	59	401.25817	5010225817	25
301.29105	7482148692	59	401.25819	5010225819	25
301.29106	7482574779	58	401.25820	5010301143	26
301.29107	7482574778	58	401.25821	5010301144	26
301.29108	7482575895	59	401.29090	7482567574	60
301.29109	7482231340	59	401.29091	7482567573	60
301.29110	7482577387	59	401.29092	7482567551	60
301.29111	7482577386	59	401.29093	7482282197	60
301.29112	7482223396	59	401.29093	7484575384	60
301.29113	7482214695	59	401.29094	7482342591	59
301.30003	5010578376	39	401.29095	7482342590	59
301.30004	5010578876	39	401.29096	7482282179	60
301.30005	5010225404	25	401.29097	7482282172	60
301.30005	5010225404	39	401.29098	7421321542	60
301.30005	5010578395	25	401.29099	7421321562	60
301.30005	5010578395	39	401.29100	7421321475	57
301.30006	5010225405	25	401.29101	7482701283	57
301.30006	5010225405	39	401.29102	7482282217	57
301.30006	5010578396	25	401.29105	7482304801	57
301.30006	5010578396	39	401.29106	7482304803	57
301.30007	5010353003	25	401.29107	7482275664	57

ALL ITEMS MENTIONED IN OUR CATALOGUE ARE NOT ORIGINAL PARTS BUT PERFECTLY INTERCHANGEABLE WITH THEM.

GOVERNING LEGISLATIONS FOR THE SALE OF OUR PRODUCTS DIFFER IN EACH COUNTRY.

INFRINGEMENTS, IF ANY, OF LOCAL LEGISLATIONS ARE RESPONSIBILITY OF THE RETAILER IN THE COUNTRY OF FINAL DISTRIBUTION.



401.30589	7420973757	39	501.04018	-	11
401.30589	7420973762	39	501.04019	-	11
401.30590	5010623600	39	501.05326	5000805326	17
401.30590	7420928994	39	501.07913	5000296871	53
401.30590	7482677299	39	501.07913	5001873673	53
401.30591	5010578335	40	501.07922	5001842202	53
401.30592	5010578336	40	501.07923	5001838475	53
401.30593	7420973757	40	501.07924	7420849799	53
401.30593	7420973762	40	501.07924	7482265705	53
401.30595	7420973757	40	501.07925	7420850409	53
401.30595	7420973762	40	501.07925	7421346867	53
401.30596	5010578350	41	501.28236	7701028236	15
401.30597	5010578348	41	501.29500	7482408492	60
401.30598	5010578346	41	501.29501	7482408447	60
401.30598	7420973875	41	501.29502	7482408493	60
401.30599	5010578344	41	501.29503	7482408449	60
401.30599	7420973877	41	501.29504	7482408450	60
401.30600	5010623600	40	501.29505	7482408451	61
401.30600	7420928994	40	501.29506	7482582181	61
401.30600	7482677299	40	501.29507	7482582213	61
401.30601	5010578335	40	501.29508	7482408487	61
401.30602	5010578336	40	501.29509	7482408433	61
401.30603	5010578354	41	501.29510	7482408488	61
401.30604	5010578355	41	501.29511	7482408435	61
401.30605	5010578352	41	501.29512	7482408482	61
401.30606	5010623600	40	501.29513	7482408426	61
401.30606	7420928994	40	501.29514	7482574172	61
401.30606	7482677299	40	501.29515	7482574171	61
401.30607	5010578335	41	501.30394	7420903746	42
401.30608	5010578336	41	501.30394	7420903887	42
401.30612	5010623600	40	501.30394	7420904269	42
401.30612	7420928994	40	501.30395	7420903745	42
401.30613	5010578812	41	501.30395	7420903885	42
401.30614	5010578813	41	501.30395	7420904268	42
401.30615	5010623600	39	501.30396	7420903746	42
401.30615	7420928994	39	501.30396	7420903883	42
401.30616	5010623600	40	501.30396	7420904269	42
401.30616	7420928994	40	501.30397	7420903745	42
401.53306	5010623869	18	501.30397	7420903882	42
401.53307	5010623868	18	501.30397	7420904268	42
401.53308	5010544308	19	501.30398	7420866665	42
401.53308	5010623868	19	501.30398	7420903881	42
401.53309	5010544309	19	501.30398	7485120820	42
401.53309	5010623869	19	501.30399	7420862795	42
401.53310	5010544070	19	501.30399	7420866665	42
401.53311	5010544069	19	501.30399	7420903880	42
401.53312	5010623890	19	501.30399	7485120820	42
401.53313	5010623889	19	501.30400	7420862795	42
401.53314	5010353105	19	501.30401	7420903745	42
401.53315	5010353104	19	501.30402	7420903746	42
401.53316	5010468538	19	501.30403	7420903882	42
401.53317	5010468537	20	501.30404	7420903883	42
401.70784	7701470784	7	501.30405	7420862779	42
401.80700	7700376750	15	501.30405	7420903880	42
501.04010	7485120974	11	501.30406	7420866665	43
501.04011	7485120981	11	501.30406	7485120820	43
501.04012	7485120975	11	501.30407	7420904268	43
501.04012	963016903R	11	501.30408	7420904269	43
501.04013	7485120982	11	501.30409	5010578503	43
501.04013	963021976R	11	501.30410	5010578504	43
501.04014	7485120988	11	501.30410	7421326550	43
501.04015	7485120990	11	501.30411	5010623057	43
501.04016	-	11	501.30412	5010623058	43
501.04017	-	11	501.30413	5010578505	43



501.30414	5010578506	43	801.53020	5010544660	27
501.30414	7421326551	43	801.53020	5010544664	27
501.30415	7420903885	43	801.53021	5010544648	27
501.30416	7420903887	43	801.53021	5010544653	27
501.30417	7420903881	43	901.25600	5010578660	20
501.30418	5010578511	43	901.25600	5010578660	33
501.30420	7420849837	20	901.25600	5010578667	20
501.30420	7420849837	33	901.25600	5010578667	33
501.30420	7420849837	44	901.25601	5010578659	20
501.30420	7482226025	20	901.25601	5010578659	33
501.30420	7482226025	33	901.25601	5010578661	20
501.30420	7482226025	44	901.25601	5010578661	33
501.31499	7420903736	44	901.30160	5010578238	45
501.31500	7420862800	44	901.30160	5010578244	45
501.31501	7420862809	44	901.30161	5010578237	45
501.31502	7420862813	44	901.30161	5010578243	45
501.31503	7420862810	44	901.50000	5010445662	27
501.31504	7420862815	44	901.50001	5010445661	27
501.31505	5010623231	44	1001.00001	5001842757	30
501.31506	5010623232	44	1001.00001	5001842757	55
501.31506	7421326527	44	1001.00011	7482962977	27
501.31507	5010623246	44	1001.00011	7482962977	45
501.31508	5010623247	44	1001.00015	5010505041	27
501.31508	7421326526	44	1001.00016	5010610723	27
501.31509	7420903723	44	1001.00016	5010610723	45
501.31510	7420903732	44	1001.00016	7421087113	27
501.31511	7420903722	45	1001.00016	7421087113	45
501.31512	7420903727	45	1001.14951	5001856184	30
501.32947	5001832947	26	1001.14951	5001856184	55
501.32948	5001832948	26	1001.23641	5001823641	30
501.32948	7421276373	26	1001.23641	5001823641	55
501.36341	5000336341	16	1001.25101	5010314693	33
501.53500	5001856292	20	1001.25102	5010610556	34
501.53500	5001856292	33	1001.25103	5010634248	34
501.53501	7421276373	20	1001.25104	5010640332	34
501.53501	7421276373	33	1001.25105	5010640331	34
501.56290	5001856290	26	1001.29100	7422078106	61
501.89377	5000289377	54	1001.29101	7482376965	62
701.19100	7485113512	54	1001.29102	7482376967	62
701.25100	7420937446	26	1001.29103	7482585431	62
701.25100	7420937446	33	1001.29104	7482585433	62
701.25600	5001850374	26	1001.29105	7482560239	62
701.29700	7482366153	61	1001.29106	7482587401	62
701.30100	5010578255	45	1001.29106	7484539338	62
701.53100	7420937430	20	1001.30000	5010304723	45
701.53104	5010353843	20	1001.30000	7420819613	45
801.04000	7485122727	12	1001.30000	7482317469	45
801.04001	7485122728	12	1001.30001	5010304722	45
801.04002	7485122295	12	1001.30001	7420819616	45
801.04002	7485122297	12	1001.30001	7482317468	45
801.04003	7485122752	12	1001.30005	7420493933	45
801.04004	7485122751	12	1001.30006	7420493931	45
801.04005	7485122298	12	1001.30101	7421094415	45
801.04006	7485122505	12	1001.30102	7421094410	46
801.04007	7485122501	12	1001.30102	7421094410	62
801.04008	7485122506	12	1001.30103	7421094456	46
801.04009	7485122504	12	1001.30103	7421094456	62
801.04010	7485122511	12	1001.30104	7421094454	46
801.04011	8200057679	12	1001.30104	7421094454	62
801.04012	8200057680	12	1001.53097	5010588488	20
801.10002	5021012002	26	1001.53098	5010417802	21
801.10101	-	27	1001.53099	5010417132	21
801.10104	-	27	1001.53100	5010544027	21
801.11001	5010211001	54	1001.53100	5010544027	27

ALL ITEMS MENTIONED IN OUR CATALOGUE ARE NOT ORIGINAL PARTS BUT PERFECTLY INTERCHANGEABLE WITH THEM.

GOVERNING LEGISLATIONS FOR THE SALE OF OUR PRODUCTS DIFFER IN EACH COUNTRY.

INFRINGEMENTS, IF ANY, OF LOCAL LEGISLATIONS ARE RESPONSIBILITY OF THE RETAILER IN THE COUNTRY OF FINAL DISTRIBUTION.



1001.53101	5010544026	21	1501.30100	7420802418	65
1001.53101	5010544026	27	1501.30100	7420802418	65
1001.53102	5010544030	28	1502.14000	-	65
1001.53102	5010544030	34	1502.14001	7425982261	65
1001.53103	5010544029	28	1502.14002	7425982262	65
1001.53103	5010544029	34	1502.14100	7422800391	65
1001.53105	5010468441	21	1502.14100	7422800391	65
1002.13005	7421094457	48	1504.10500	5001847587	31
1002.13005	7421094457	55	1504.10501	5001847584	31
1002.13006	7421090272	46	1601.00000	7701044520	7
1002.13006	7421090272	62	1601.00001	7701044518	7
1002.13007	7421213203	46	1601.00002	7701044523	7
1002.13007	7421213203	62	1601.00003	7701044522	7
1002.13008	7421094413	63	1601.00004	7700353947	7
1002.13010	7420842848	46	1601.00005	7700353946	7
1002.56557	-	55	1601.03800	8200163518	9
1002.56558	7420498623	48	1601.03801	8200163516	9
1002.56558	7420498623	55	1601.03802	8200163918	8
1006.33602	5001833310	28	1601.03803	8200163914	8
1006.33602	5001833310	46	1601.03804	8200263364	9
1101.29800	7482585426	63	1601.03805	8200263356	9
1101.29801	7482585425	63	1601.04080	7485120611	12
1101.29802	7482291434	63	1601.04081	7485120616	12
1101.29803	7482291437	63	1601.04082	8200002470	13
1101.50010	5001834442	28	1601.04082	8200301027	13
1101.50011	5001834444	28	1601.04083	8200002469	13
1401.29500	7482510549	63	1601.04083	8200301026	13
1401.29501	7482510548	63	1601.05060	5001872437	14
1401.29502	7482517788	63	1601.05061	5001872439	14
1401.29503	7482517786	63	1601.05062	26010-MB400	14
1401.29504	7482510542	63	1601.05063	26060-MB400	14
1401.29505	7482510540	63	1601.23600	5010544978	54
1401.29506	7482516638	63	1601.23600	5010623619	54
1401.29507	7482516626	63	1601.23601	5010623620	54
1500.00000	-	49	1601.23603	5010312972	54
1500.00001	-	49	1601.23603	7420881197	54
1501.03000	4421266	9	1601.23604	5010271807	54
1501.03000	4421266	14	1601.29800	7482622151	63
1501.03000	4421266	15	1601.29800	7482622240	63
1501.03000	4421266	22	1601.29801	7482622235	63
1501.03000	5001870556	9	1601.29801	7482622242	63
1501.03000	5001870556	14	1601.29802	7482622272	64
1501.03000	5001870556	15	1601.29803	7482622276	64
1501.03000	5001870556	22	1601.29804	7482252916	64
1501.03001	4421265	9	1601.29805	7482252914	64
1501.03001	4421265	14	1601.30800	5010578476	47
1501.03001	4421265	15	1601.30800	7421636310	47
1501.03001	4421265	22	1601.30800	7482588693	47
1501.03001	7485118470	9	1601.30801	5010578452	47
1501.03001	7485118470	14	1601.30801	7421636296	47
1501.03001	7485118470	15	1601.30801	7482588679	47
1501.03001	7485118470	22	1601.30802	5010578478	47
1501.03100	5001847153	9	1601.30802	7421636312	47
1501.03100	5001847153	14	1601.30803	5010578454	47
1501.03100	5001847153	15	1601.30803	7482588681	47
1501.03100	5001847153	22	1601.30804	5010578475	47
1501.30000	7420802350	49	1601.30804	7421636309	47
1501.30000	7420802350	65	1601.30804	7482588692	47
1501.30001	7420802348	49	1601.30805	5010578451	47
1501.30001	7420802348	65	1601.30805	7421636295	47
1501.30002	7420802353	49	1601.30805	7482588678	47
1501.30002	7420802353	65	1601.50013	5001847589	28
1501.30100	7420802418	49	1601.50014	5001834564	28
1501.30100	7420802418	49	1601.50015	5001834568	21



1601.50015	5001834568	29	1901.23600	5010468940	55
1601.50016	5010468981	29	1901.23600	7421275875	55
1601.50017	5010468980	29	1901.30700	-	48
1601.50018	5001834565	21	1901.30701	-	48
1601.50018	5001834565	29	1901.30702	5010301994	48
1601.50018	7421103284	21	1901.30702	7422189861	48
1601.50018	7421103284	29	1901.30702	7482497194	48
1601.50019	5001840476	29	1901.30703	5010301993	48
1601.50020	5001840475	29	1901.30703	7422189860	48
1601.50021	5001834560	29	1901.30703	7482497193	48
1601.50022	5001834559	29	2000.00016	-	35
1601.50023	5010231849	29	2101.30080	7485132205	34
1601.50024	5010231850	29	2101.30080	7485132205	48
1601.50025	5001834561	46	2401.25100	5010353703	34
1601.50026	5010231670	29	2401.25101	5010468003	34
1601.50027	5010231669	29	2401.30100	5010578586	49
1601.53600	5010468981	21	2401.30101	5010623483	34
1601.53601	5010468980	21	2401.30101	5010623483	49
1701.29700	7482275921	64	2401.30101	7484838520	34
1701.29701	7482275772	64	2401.30101	7484838520	49
1701.29702	7423005983	64	2401.50100	5010225922	31
1701.29703	7423005984	64	2401.50101	5010353702	31
1701.29708	7482589732	64	2401.53100	5010468464	22
1701.29709	7482589730	64	2401.53101	5010623108	22
1701.29710	7482232463	64	3001.29000	7484539407	64
1701.29711	7482230393	64	3002.00002	-	22
1701.30600	5010225459	47	3002.00002	-	49
1701.30600	5010468879	47			
1701.53600	5001858130	21			
1701.53600	5001858130	29			
1701.53601	5001858129	21			
1701.53601	5001858129	29			
1701.536025001858130 + 5001834847		30			
1701.536035001858129 + 5001834847		30			
1701.53604	-	30			
1701.53605	-	30			
1701.53606	5010220068	30			
1701.53607	5010220067	30			
1701.53608	5010225930	47			
1701.53609	5010225908	47			
1701.53610	20864258	30			
1701.53610	20864258	47			
1701.53610	7420864258	30			
1701.53610	7420864258	47			
1701.53611	20864256	47			
1701.53611	7420864256	47			
1701.53612	5010353170	47			
1701.53612	7482690386	47			
1701.53613	5010225716	48			
1701.53614	5001858127	48			
1701.53615	5001858126	48			
1701.53616	5010468880	22			
1701.53616	5010468880	48			
1701.60600	5010441111	54			
1701.60600	7421015813	54			
1701.60601	5010353608	54			
1701.60601	7421015810	54			
1801.36000	7700351250	7			
1801.36000	8200106346	7			
1801.53000	5010220975	22			
1801.73000	5010220413	30			
1801.78000	5001853757	54			
1901.00500	8200162710	7			
1901.00500	8200162710	15			
			1901.23600	5010468940	55
			1901.23600	7421275875	55
			1901.30700	-	48
			1901.30701	-	48
			1901.30702	5010301994	48
			1901.30702	7422189861	48
			1901.30702	7482497194	48
			1901.30703	5010301993	48
			1901.30703	7422189860	48
			1901.30703	7482497193	48
			2000.00016	-	35
			2101.30080	7485132205	34
			2101.30080	7485132205	48
			2401.25100	5010353703	34
			2401.25101	5010468003	34
			2401.30100	5010578586	49
			2401.30101	5010623483	34
			2401.30101	5010623483	49
			2401.30101	7484838520	34
			2401.30101	7484838520	49
			2401.50100	5010225922	31
			2401.50101	5010353702	31
			2401.53100	5010468464	22
			2401.53101	5010623108	22
			3001.29000	7484539407	64
			3002.00002	-	22
			3002.00002	-	49

COS.VO

COS.PEL ref.	SIMILAR ref.	PAG
003000	20398660	109
003000	20789440	109
003001	20734485	109
003002	-	110
003120	-	73
003120	-	86
003120	-	123
003120	-	136
003121	-	73
003122	-	113
003123	-	113
005880	8191748	92
005890	8191747	92
006000	3981456	100
006007	-	113
006008	21097450	81
006008	21097450	113
006010	3981455	100
006011	20507623	81
006011	20507623	114
006011	20892386	81
006011	20892386	114
006011	21097449	81
006011	21097449	114
006012	20507624	81
006012	20507624	114
006012	20892384	81
006012	20892384	114
006012	21097448	81
006012	21097448	114
006013	20565103	114
006013	21063887	114



006014	20565104	114	102.53717	20456963	101
006014	21063895	114	102.53717	20533138	101
010080	20425732	81	102.53718	20409818	101
010080	20425732	81	102.53718	20529704	101
010080	20425732	113	102.53719	20379357	101
010080	20425732	114	102.53719	20529668	101
010080	20910229	81	102.53720	20379358	101
010080	20910229	81	102.53720	20529672	101
010080	20910229	113	102.53960	20453690	101
010080	20910229	114	102.53960	20453690	116
010081	20565107	114	102.53960	20453960	101
011111	8142919	92	102.53960	20453960	116
011117	-	113	102.53960	21425186	101
011211	3981782	100	102.53960	21425186	116
102.12163	1621181	89	102.60266	20360266	102
102.13100	21190825	115	102.64100	8191421	77
102.13100	82056727	115	102.64101	8191406	77
102.13102	82056840	115	102.65100	3175376	79
102.13102	82065607	115	102.66100	84162402	82
102.13103	82065609	115	102.66101	82431911	82
102.13104	82063911	115	102.66101	84162403	82
102.13105	82062209	115	102.66102	84086799	82
102.13106	82072463	115	102.66102	84577628	82
102.13107	82063513	116	102.66103	82430056	82
102.13108	82065120	116	102.66104	82430057	82
102.14100	82360122	124	102.66105	82448110	83
102.14101	82491903	124	102.66106	82448104	83
102.14102	84027588	124	102.66107	82419490	83
102.14103	82858486	124	102.66108	82419488	83
102.14104	82858516	124	102.66109	82454672	83
102.14105	82248327	124	102.66110	82455156	83
102.14106	82248338	125	102.66111	82444204	83
102.14107	82248340	125	102.66112	82454671	83
102.14108	82248325	125	102.66113	82409793	83
102.14109	82258426	125	102.66114	82410206	83
102.14110	82208512	125	102.75545	20529705	102
102.14110	82220161	125	102.75545	21023794	102
102.14111	82180491	125	102.75545	3175545	102
102.14112	82255346	125	102.75546	20529706	102
102.14113	82220206	125	102.75546	21023797	102
102.14113	82298657	125	102.75546	3175546	102
102.14114	82177794	125	102.75547	20529707	102
102.14115	82219161	126	102.75547	3175547	102
102.14115	84033228	126	102.75548	20529708	102
102.14116	82285617	126	102.75548	21023802	102
102.14116	84058023	126	102.75548	3175548	102
102.14117	84024496	126	102.91220	8191220	93
102.14117	84046776	126	201.30545	21094389	84
102.14118	82846116	126	201.30545	21094389	127
102.14119	82846118	126	201.30545	21094457	84
102.14120	84151824	82	201.30545	21094457	127
102.14121	84151777	82	201.30547	21094389	84
102.14122	82298483	126	201.30547	21094389	127
102.31100	21849913	74	201.30549	21094393	84
102.31101	82523575	74	201.30549	21094393	127
102.44455	20360507	93	201.30550	21094392	84
102.44455	8144455	93	201.30550	21094392	127
102.44482	1063509	77	202.13199	21094387	84
102.44482	1063509	93	202.13199	21094387	116
102.44482	8144482	77	202.13199	21094387	127
102.44482	8144482	93	202.13199	21094457	84
102.53716	20453716	101	202.13199	21094457	116
102.53716	20516776	101	202.13199	21094457	127
102.53716	21358670	101	202.13200	21094387	84



202.13200	21094387	117	202.65200	3175159	77
202.13200	21094387	128	202.65200	3175159	79
202.13201	21094394	84	202.65201	20425469	77
202.13201	21094394	117	202.65201	20425469	79
202.13201	21094394	128	202.65201	20529478	77
202.13202	21094391	84	202.65201	20529478	79
202.13202	21094391	117	202.65201	20537185	77
202.13202	21094391	128	202.65201	20537185	79
202.13202	21094397	84	202.65201	3175158	77
202.13202	21094397	117	202.65201	3175158	79
202.13202	21094397	128	202.65202	20529765	77
202.13203	21094384	85	202.65202	20529765	79
202.13203	21094384	117	202.65202	3981043	77
202.13203	21094384	128	202.65202	3981043	79
202.13203	21094388	85	202.71380	20549696	103
202.13203	21094388	117	202.71380	20723630	103
202.13203	21094388	128	202.71381	1079981	103
202.13204	21094388	85	202.71381	20549696	103
202.13204	21094388	117	202.71381	20723630	103
202.13204	21094388	128	202.71387	1079981	103
202.13204	21094457	85	202.71387	20936769	103
202.13204	21094457	117	202.71389	1079965	94
202.13204	21094457	128	202.71389	1079965	103
202.13205	20843850	103	202.71389	1079981	94
202.13205	20843850	117	202.71389	1079981	103
202.13206	-	103	202.71389	20722652	94
202.13206	-	117	202.71389	20722652	103
202.13207	1079997	103	202.71389	20936759	94
202.13207	1079997	117	202.71389	20936759	103
202.14200	21413763	126	202.71389	3171391	94
202.14200	84233571	126	202.71389	3171391	103
202.14201	21940892	126	202.71390	1079965	95
202.14202	21094406	126	202.71390	1079965	104
202.14203	21413732	126	202.71390	20722652	95
202.14203	82181355	126	202.71390	20722652	104
202.14204	82328081	127	202.71390	20936759	95
202.14204	84096589	127	202.71390	20936759	104
202.14205	82328082	127	202.71390	3171391	95
202.14205	84096588	127	202.71390	3171391	104
202.14207	82637695	83	202.71391	20936769	104
202.14207	82637695	127	202.75246	3175247	94
202.14207	84007259	83	202.75246	3981764	94
202.14207	84007259	127	202.75246	8144108	94
202.14208	82141524	127	202.75246	8189196	94
202.14209	82110404	127	202.75246	8189301	94
202.14210	82637711	84	202.75247	3175246	94
202.14210	82637711	127	202.75247	3981762	94
202.14211	82637710	84	202.75247	8144107	94
202.14211	82637710	127	202.75247	8189195	94
202.16121	1623888	89	202.75247	8189300	94
202.23459	1623459	93	202.75927	3175927	102
202.41236	8122894	93	202.75927	3175927	116
202.41236	8141237	93	202.75928	3175928	102
202.41237	8122893	93	202.75928	3175928	116
202.41237	8141236	93	202.75929	3175929	102
202.44551	8144551	94	202.75929	3175929	116
202.44552	8144552	94	202.75930	21302470	102
202.55807	8155808	94	202.75930	21302470	116
202.55807	8156556	94	202.75930	3175930	102
202.55808	8155808	94	202.75930	3175930	116
202.56551	8156551	94	202.75931	20372064	102
202.56552	8156552	94	202.75931	20372064	116
202.65200	20529483	77	202.75932	20372065	102
202.65200	20529483	79	202.75932	20372065	116

ALL ITEMS MENTIONED IN OUR CATALOGUE ARE NOT ORIGINAL PARTS BUT PERFECTLY INTERCHANGEABLE WITH THEM.

GOVERNING LEGISLATIONS FOR THE SALE OF OUR PRODUCTS DIFFER IN EACH COUNTRY.

INFRINGEMENTS, IF ANY, OF LOCAL LEGISLATIONS ARE RESPONSIBILITY OF THE RETAILER IN THE COUNTRY OF FINAL DISTRIBUTION.



202.75933	20529682	102	402.14089	82090731	129
202.75933	3175933	102	402.14090	21413787	85
202.75934	20529684	102	402.14090	21413787	129
202.75934	3175934	102	402.14091	21413789	85
202.75935	20453900	102	402.14091	21413789	129
202.75935	20453900	116	402.14092	21413786	85
202.75936	20529686	103	402.14092	21413786	129
202.75937	20529685	103	402.14093	82101912	129
202.92544	20392544	95	402.14094	82101914	130
202.92544	20392544	104	402.14095	82101910	130
202.92547	20721840	94	402.14096	21495267	130
301.30003	20593721	70	402.14097	21495266	130
301.30004	20593735	70	402.14098	21495268	130
301.53000	20538003	68	402.14099	21838427	130
301.53000	20538003	74	402.14099	22247766 FONDO	130
301.53001	20538006	68	402.14100	21838939	130
301.53001	20538006	74	402.14100	21838945 FONDO	130
302.14100	21344649	128	402.14101	21838944 FONDO	130
302.14100	21392187	128	402.14101	21868931	130
302.14101	21344647	128	402.31090	22376336	74
302.14101	21392183	128	402.31090	82642339	74
302.14102	82141521	128	402.31091	84000742	74
302.14103	82136982	128	402.31092	82523848	75
302.14104	82819477	128	402.31093	82523847	75
302.14105	82819482	128	402.31094	82992302	75
302.14106	82142373	129	402.31095	82992301	75
302.14107	82141971	129	402.31096	82531174	75
302.30004	20593734	70	402.31097	82524665	75
302.30006	20593731	70	402.31098	82534529	75
302.41003	8141003	95	402.31099	82534527	75
302.41004	8141004	95	402.58216	8158216	89
302.41004	8141313	95	402.73830	1573830	88
302.41005	8141312	95	402.74997	20425625	104
302.41007	20529638	104	402.74997	20425625	118
302.41007	20529638	118	402.74997	21359080	104
302.41007	3175406	104	402.74997	21359080	118
302.41007	3175406	118	402.74998	20425627	104
302.41008	20529640	104	402.74998	20425627	118
302.41008	20529640	118	402.74998	21359090	104
302.41008	3175407	104	402.74998	21359090	118
302.41008	3175407	118	402.74999	20425626	104
302.64300	1062134	78	402.74999	20425626	118
302.64300	8191594	78	402.74999	21359082	104
302.64301	1062133	78	402.74999	21359082	118
302.64301	8191593	78	402.75000	20529740	79
302.66100	21520119	85	402.75000	20529740	104
302.66101	21520015	85	402.75000	20529740	118
401.30603	25369342	70	402.75000	3175417	79
401.30604	25369343	70	402.75000	3175417	104
401.30605	25369341	70	402.75000	3175417	118
402.12090	20961733	68	402.75001	20529741	79
402.14084	21316576	85	402.75001	20529741	104
402.14084	21316576	129	402.75001	20529741	118
402.14084	22249883	85	402.75001	3175418	79
402.14084	22249883	129	402.75001	3175418	104
402.14085	21316575	85	402.75001	3175418	118
402.14085	21316575	129	402.75002	20529742	79
402.14086	21316577	85	402.75002	20529742	104
402.14086	21316577	129	402.75002	20529742	118
402.14087	82090733	129	402.75002	3175419	79
402.14087	84195623	129	402.75002	3175419	104
402.14088	21413786	129	402.75002	3175419	118
402.14088	82090735	129	402.75003	20398709	105
402.14089	21413789	129	402.75003	20429679	105



402.75003	20711859	105	501.31504	20862810	71
402.75003	21828914	105	501.31505	20207881	69
402.75004	20398708	105	501.31505	20207881	71
402.75004	20429681	105	501.31505	20707881	69
402.75004	20711861	105	501.31505	20707881	71
402.75004	21829052	105	501.31505	20903722	69
402.75005	20398707	105	501.31505	20903722	71
402.75005	20429680	105	501.31506	20703983	69
402.75005	20711860	105	501.31506	20703983	71
402.75005	21829051	105	501.31506	21326527	69
402.75006	20467448	105	501.31506	21326527	71
402.75007	20456804	80	501.31507	20707874	71
402.75007	20456804	105	501.31508	20708303	71
402.75007	21430599	80	501.31508	21326526	71
402.75007	21430599	105	501.31508	21475603	71
402.75008	20456806	80	501.31509	20903732	72
402.75008	20456806	105	501.31510	20903723	72
402.75008	21430672	80	501.31511	20903722	72
402.75008	21430672	105	501.31512	20903727	72
402.75009	20456805	80	502.00000	3091259	95
402.75009	20456805	105	502.00001	3091256	95
402.75009	21430600	80	502.13602	20716739	118
402.75009	21430600	105	502.13604	20900679	105
402.75010	20456550	105	502.13604	20900679	118
402.75010	20467442	105	502.13604	21151129	105
402.75010	21484901	105	502.13604	21151129	118
402.75011	20433678	105	502.13605	20900682	106
402.75011	20433678	118	502.13605	20900682	119
402.75011	20453676	105	502.13605	21151132	106
402.75011	20453676	118	502.13605	21151132	119
402.75012	20453677	105	502.13606	20716956	106
402.75012	20453677	118	502.13606	20716956	119
402.75012	20453679	105	502.14500	82943356	130
402.75012	20453679	118	502.14501	82943538	130
402.88888	3981256	78	502.14502	82359214	130
402.88888	3981256	95	502.14503	82356810	130
402.88888	8152722	78	502.14504	82356824	130
402.88888	8152722	95	502.14505	82268557	131
402.88888	8189337	78	502.14506	82268562	131
402.88888	8189337	95	502.14507	21765994	131
402.89327	1626679	78	502.14507	82944866	131
402.89327	1626679	95	502.14508	21766009	131
402.89327	20372226	78	502.14508	82945196	131
402.89327	20372226	95	502.14509	84004927	131
402.89328	1626680	78	502.14510	84004929	131
402.89328	1626680	95	502.14510	84167321	131
402.89328	20372227	78	502.33333	1697007	89
402.89328	20372227	95	502.44444	1699014	89
402.89329	8144454	78	502.55986	20455986	106
402.89329	8144454	95	502.55986	20567670	106
402.89329	8189329	78	502.55995	20455995	106
402.89329	8189329	95	502.55995	20567685	106
501.30400	20862795	68	502.62798	20360806	106
501.30400	20862795	71	502.62799	20360807	106
501.30405	20862779	68	502.62799	20360811	106
501.30405	20862779	71	502.62799	20455995	106
501.30406	20862782	71	502.62800	20360811	106
501.31500	20862800	68	502.62801	20360810	106
501.31500	20862800	71	502.62801	20746401	106
501.31501	20862809	71	502.62802	20455982	106
501.31502	20862813	71	502.62802	20567647	106
501.31503	20862815	69	502.62802	20936170	106
501.31503	20862815	71	502.62803	20455981	106
501.31504	20862810	69	502.62803	20455984	106

ALL ITEMS MENTIONED IN OUR CATALOGUE ARE NOT ORIGINAL PARTS BUT PERFECTLY INTERCHANGEABLE WITH THEM.

GOVERNING LEGISLATIONS FOR THE SALE OF OUR PRODUCTS DIFFER IN EACH COUNTRY.

INFRINGEMENTS, IF ANY, OF LOCAL LEGISLATIONS ARE RESPONSIBILITY OF THE RETAILER IN THE COUNTRY OF FINAL DISTRIBUTION.



502.62803	20567637	106	1002.13013	21297258	120
502.62803	20936169	106	1002.13014	21297261	120
502.62804	-	107	1002.14001	82232959	131
502.62805	-	107	1002.14002	82213089	131
502.91756	3092854	96	1002.14018	82859306	132
502.91757	20854568	96	1002.14019	82171603	132
502.91757	21203311	96	1002.14020	22078082	132
502.91757	3091757	96	1002.14021	82142329	132
502.99011	1699011	90	1002.14022	82151656	132
502.99013	1699013	90	1002.14025	82846112	132
502.99017	1699017	90	1002.14026	82846107	132
701.53104	20937431	72	1002.14027	84025801	132
701.53104	20937431	75	1002.14028	84026559	132
702.00012	1584316	90	1002.14029	84025799	132
702.01212	8189318	96	1002.14030	82943981	132
702.01216	8189310	96	1002.14031	82928883	132
702.01218	20847082	107	1002.14032	82151654	132
702.01219	20527443	107	1002.14033	82142327	132
702.01220	20456709	107	1002.21148	1621449	90
702.14900	82131055	131	1002.21149	1621448	90
702.14900	84014254	131	1002.21450	1621451	90
702.14901	21443604	131	1002.21451	1621450	90
702.14901	82166469	131	1002.21905	1621905	90
802.99017	-	96	1002.21906	1621907	90
802.99018	-	96	1002.40333	8140333	96
902.14077	-	131	1002.51346	8151345	91
902.31600	21849885	75	1002.56556	8156556	99
902.31601	21849884	75	1002.56557	1079981	99
902.31602	21849909	75	1002.56557	1079981	112
902.31603	21849897	75	1002.56558	20498623	113
902.85000	20391583	107	1002.56559	20498620	107
902.98144	1698145	90	1002.56559	20583434	107
902.98145	1698144	90	1002.56559	3987252	107
902.99000	-	96	1002.56560	20466895	107
902.99001	-	96	1002.56561	20383038	108
1001.53100	20538011	69	1002.56562	20382890	108
1001.53100	20538011	72	1002.56564	20583440	108
1001.53100	20538011	75	1002.60788	20360789	108
1001.53101	20538012	69	1002.60789	20360788	108
1001.53101	20538012	72	1002.66000	84104144	85
1001.53101	20538012	75	1002.66001	84104142	85
1001.53102	20538248	72	1002.77451	1077451	96
1001.53103	20538247	72	1002.80061	1080061	91
1002.02004	-	107	1002.89123	1089122	91
1002.09844	1509844	88	1002.91005	20507252	97
1002.09846	1509846	88	1002.91005	20507252	108
1002.13000	20545095	119	1002.91005	3127594	97
1002.13001	20545094	119	1002.91005	3127594	108
1002.13002	82252302	119	1002.91313	20379437	97
1002.13003	82060441	119	1002.91313	8191313	97
1002.13004	82060445	119	1002.91314	20379438	97
1002.13005	21094457	86	1002.91314	8191314	97
1002.13005	21094457	123	1002.91315	20379439	97
1002.13005	21094457	135	1002.91315	20379439	108
1002.13006	21090272	119	1002.91315	8191315	97
1002.13007	21213202	119	1002.91315	8191315	108
1002.13007	21213203	119	1002.91401	8191401	97
1002.13008	21094413	119	1002.91402	8191402	97
1002.13009	-	120	1002.99013	-	97
1002.13010	20842848	120	1002.99014	-	97
1002.13010	21412897	120	1102.13500	82056986	120
1002.13010	21924923	120	1102.13500	82209849	120
1002.13011	21068469	120	1102.13500	82367957	120
1002.13012	21068473	120	1102.13501	82053690	120



1102.13501	82209788	120	1102.62557	20534600	109
1102.13501	82367098	120	1102.62557	20827042	109
1102.13502	21478755	120	1102.62557	20917957	109
1102.13502	82076266	120	1102.62558	20453628	109
1102.13503	21478759	120	1102.62558	20534601	109
1102.13503	82076158	120	1102.62558	20827044	109
1102.13504	21451002	121	1102.62558	20917958	109
1102.13504	82056991	121	1102.62559	20467387	109
1102.13505	21451000	121	1102.62560	20467388	109
1102.13505	82052484	121	1102.64500	20398388	78
1102.13506	21478751	121	1102.64500	20398390	78
1102.13506	82114502	121	1102.64500	81915870	78
1102.13507	21448885	121	1102.64501	1062163	78
1102.13507	82114504	121	1102.64501	20398387	78
1102.13508	21078545	121	1102.64501	20398389	78
1102.13509	21078543	121	1102.66600	21963141	86
1102.14600	21874457	133	1102.66601	21963005	86
1102.14601	21874450	133	1102.66602	84027783	86
1102.14602	82884084	133	1102.66603	84028392	86
1102.14603	82884080	133	1102.88870	1088871	91
1102.14604	82453926	133	1102.88871	1088870	91
1102.14605	82446592	133	1102.98146	1698147	91
1102.14606	21413774	133	1102.98147	1698146	91
1102.14607	21413734	133	1202.10782	1610783	91
1102.14608	82462703	133	1202.10783	1610782	91
1102.14608	84034942	133	1202.64700	8191412	78
1102.14608	84139933	133	1202.64701	8191409	78
1102.14609	82462702	133	1202.65180	20379172	80
1102.14609	84034945	133	1202.65181	20379171	80
1102.14609	84139886	133	1202.79175	20379175	109
1102.14610	-	133	1202.79175	20379175	121
1102.21182	1621183	91	1202.79176	20379176	109
1102.21183	1621182	91	1202.79176	20379176	121
1102.41289	8141289	78	1202.89092	1619149	98
1102.41289	8141289	97	1202.89092	8189093	98
1102.41290	8141290	78	1202.89093	1619148	98
1102.41290	8141290	97	1202.89093	8189092	98
1102.62547	1062547	97	1402.14500	21642399	133
1102.62547	20398385	97	1402.14500	82178247	133
1102.62547	3090972	97	1402.14501	21642377	133
1102.62547	3980869	97	1402.14501	82107271	133
1102.62548	1062548	97	1402.67037	20467037	109
1102.62548	20398386	97	1402.67037	21299955	109
1102.62548	3090971	97	1402.67038	20467038	109
1102.62548	3980870	97	1402.67038	21300059	109
1102.62549	20452886	108	1402.86533	1086533	98
1102.62549	21469918	108	1402.86533	1619690	98
1102.62550	20452887	108	1402.86533	20398907	98
1102.62550	21469924	108	1402.86534	1086534	98
1102.62551	20452847	108	1402.86534	1619691	98
1102.62552	20452848	108	1402.86534	20398908	98
1102.62553	20425418	109	1500.00000	-	114
1102.62553	20826227	109	1500.00001	-	114
1102.62553	21430598	109	1501.03000	20769784	73
1102.62554	20425419	109	1501.03001	20769783	73
1102.62554	20826231	109	1501.03100	20537280	73
1102.62554	21469979	109	1502.14000	82849923	86
1102.62555	20453930	109	1502.14000	82849923	123
1102.62555	20507020	109	1502.14000	82849923	136
1102.62555	21359257	109	1502.14000	84195521	86
1102.62556	20453931	109	1502.14000	84195521	123
1102.62556	20507021	109	1502.14000	84195521	136
1102.62556	21359260	109	1502.14000	84441768	86
1102.62557	20453627	109	1502.14000	84441768	123

ALL ITEMS MENTIONED IN OUR CATALOGUE ARE NOT ORIGINAL PARTS BUT PERFECTLY INTERCHANGEABLE WITH THEM.

GOVERNING LEGISLATIONS FOR THE SALE OF OUR PRODUCTS DIFFER IN EACH COUNTRY.

INFRINGEMENTS, IF ANY, OF LOCAL LEGISLATIONS ARE RESPONSIBILITY OF THE RETAILER IN THE COUNTRY OF FINAL DISTRIBUTION.



1502.14000	84441768	136	1602.13800	21035637	122
1502.14001	82849894	86	1602.13800	21323106	122
1502.14001	82849894	123	1602.13801	21035638	122
1502.14001	82849894	136	1602.13801	21323108	122
1502.14001	84195505	86	1602.13802	21035690	122
1502.14001	84195505	123	1602.13802	21297909	122
1502.14001	84195505	136	1602.13803	21035692	122
1502.14001	84441766	86	1602.13803	21297911	122
1502.14001	84441766	123	1602.13804	82114500	121
1502.14001	84441766	136	1602.13805	82114506	121
1502.14002	82849925	87	1602.13806	82078418	121
1502.14002	82849925	123	1602.13807	21035645	122
1502.14002	82849925	136	1602.13807	21323114	122
1502.14002	84195519	87	1602.13808	21035644	122
1502.14002	84195519	123	1602.13808	21323113	122
1502.14002	84195519	136	1602.13809	21297918	122
1502.14002	84441767	87	1602.13810	21297917	122
1502.14002	84441767	123	1602.13811	82116545	80
1502.14002	84441767	136	1602.13811	82116545	121
1502.14003	21735301	76	1602.13812	21087346	121
1502.14003	21735301	87	1602.13813	21087347	122
1502.14003	21735301	136	1602.14800	21221129	86
1502.14003	84441936	76	1602.14800	21221129	134
1502.14003	84441936	87	1602.14800	22239217	86
1502.14003	84441936	136	1602.14800	22239217	134
1502.14004	21735299	76	1602.14801	21221130	86
1502.14004	21735299	87	1602.14801	21221130	134
1502.14004	21735299	136	1602.14801	22239219	86
1502.14004	84441937	76	1602.14801	22239219	134
1502.14004	84441937	87	1602.14802	21608661	134
1502.14004	84441937	136	1602.14802	22239225	134
1502.14005	82483074	76	1602.14803	21608663	134
1502.14005	82483074	87	1602.14803	22239226	134
1502.14005	82483074	136	1602.14804	21221145	134
1502.14005	84441759	76	1602.14804	22239248	134
1502.14005	84441759	87	1602.14805	21221142	134
1502.14005	84441759	136	1602.14805	22239254	134
1502.14006	82483073	76	1602.14807	21221134	86
1502.14006	82483073	87	1602.14807	21221134	134
1502.14006	82483073	136	1602.14807	22239221	86
1502.14006	84441760	76	1602.14807	22239221	134
1502.14006	84441760	87	1602.14808	21221133	86
1502.14006	84441760	136	1602.14808	21221133	134
1502.14100	82849905	86	1602.14808	22239220	86
1502.14100	82849905	87	1602.14808	22239220	134
1502.14100	82849905	123	1602.14809	82151157	86
1502.14100	82849905	123	1602.14809	82151157	133
1502.14100	82849905	136	1602.14810	82151205	86
1502.14100	82849905	136	1602.14810	82151205	133
1502.14101	84122332	76	1602.14811	21346521	134
1502.14101	84122332	76	1602.14812	21346522	134
1502.14101	84122332	87	1602.14813	21608667	134
1502.14101	84122332	87	1602.14813	22239234	134
1502.14101	84122332	136	1602.14814	21608666	134
1502.14101	84122332	136	1602.14814	22239232	134
1601.50015	20745227	72	1602.14815	21221154	134
1601.50018	21103284	72	1602.14815	22332595	134
1602.12700	20818771	69	1602.14816	21221153	134
1602.12701	20818763	69	1602.14816	22332594	134
1602.12702	20779458	72	1602.14817	21221156	134
1602.13798	21123489	122	1602.14817	22332597	134
1602.13798	82304585	122	1602.14818	21221155	134
1602.13799	21123523	122	1602.14818	22332596	134
1602.13799	82304599	122	1602.14819	21221157	135



1602.14819	22332598	135	1702.14605	20372039	111
1602.14820	21221158	135	1702.14605	20372039	122
1602.14820	22332600	135	1702.14605	20372039	135
1602.14821	21221160	135	1702.14606	1623248	111
1602.14821	22332604	135	1702.14606	1623248	122
1602.14822	21221159	135	1702.14606	1623248	135
1602.14822	22332603	135	1702.14606	20372038	111
1602.14823	21221152	135	1702.14606	20372038	122
1602.14823	22332593	135	1702.14606	20372038	135
1602.14824	21221151	135	1702.14606	20398136	111
1602.14824	22332592	135	1702.14606	20398136	122
1602.31600	82532284	76	1702.14606	20398136	135
1602.31601	82526640	76	1702.14607	1623147	111
1602.60273	20360273	98	1702.14607	1623147	122
1602.60274	20360274	98	1702.14607	1623147	135
1602.61658	20425484	110	1702.14607	20372037	111
1602.61659	20398824	110	1702.14607	20372037	122
1602.61660	1623726	110	1702.14607	20372037	135
1602.61661	1623727	110	1702.14607	20398135	111
1602.61662	-	110	1702.14607	20398135	122
1602.61663	20763004	111	1702.14607	20398135	135
1602.61663	20861573	111	1702.14608	1062636	111
1602.61663	21001645	111	1702.14608	1062636	123
1602.61664	20763003	111	1702.14608	1062636	135
1602.61664	20861574	111	1702.65598	-	111
1602.61664	21001649	111	1702.65599	-	111
1602.61665	20379428	111	1702.65600	1062566	80
1602.61665	20710524	111	1702.65600	1062566	98
1602.61666	20379429	111	1702.65600	1062566	111
1602.61666	20710525	111	1702.65600	20398467	80
1602.61667	20360898	111	1702.65600	20398467	98
1602.61667	20713720	111	1702.65600	20398467	111
1602.61667	20762992	111	1702.65600	3175919	80
1602.61667	20861583	111	1702.65600	3175919	98
1602.61667	20862575	111	1702.65600	3175919	111
1602.61667	21001663	111	1702.65601	1062565	80
1602.61668	20360899	111	1702.65601	1062565	98
1602.61668	20713721	111	1702.65601	1062565	111
1602.61668	20762993	111	1702.65601	20398466	80
1602.61668	20861576	111	1702.65601	20398466	98
1602.61668	20861584	111	1702.65601	20398466	111
1602.61668	21001668	111	1702.65601	3175918	80
1602.61669	20409874	110	1702.65601	3175918	98
1602.61669	20826211	110	1702.65601	3175918	111
1602.61670	20409875	110	1702.65602	20530146	112
1602.61670	20826213	110	1702.65602	3175367	112
1602.61671	-	110	1702.65603	20383543	112
1602.81665	1062190	98	1702.65604	3175366	112
1602.81665	22105756	98	1702.65605	1063327	99
1602.81666	3981666	98	1702.65605	1063327	112
1602.81666	8191142	98	1702.65605	8142043	99
1602.81668	3981668	98	1702.65605	8142043	112
1602.81669	3981594	98	1702.65606	1063328	99
1602.93922	3175032	92	1702.65606	1063328	112
1602.93923	1593923	91	1702.65606	8142044	99
1602.93924	1593924	91	1702.65606	8142044	112
1701.53600	24426875	73	1702.65607	20588325	80
1701.53601	24426873	73	1702.65607	20588325	112
1702.13700	21350581	69	1702.65607	21261274	80
1702.13700	21350581	73	1702.65607	21261274	112
1702.14604	82208564	135	1702.65607	21505893	80
1702.14605	1062637	111	1702.65607	21505893	112
1702.14605	1062637	122	1702.65608	20588326	80
1702.14605	1062637	135	1702.65608	20588326	112

ALL ITEMS MENTIONED IN OUR CATALOGUE ARE NOT ORIGINAL PARTS BUT PERFECTLY INTERCHANGEABLE WITH THEM.

GOVERNING LEGISLATIONS FOR THE SALE OF OUR PRODUCTS DIFFER IN EACH COUNTRY.

INFRINGEMENTS, IF ANY, OF LOCAL LEGISLATIONS ARE RESPONSIBILITY OF THE RETAILER IN THE COUNTRY OF FINAL DISTRIBUTION.



1702.65608	21261275	80	003123	-	193
1702.65608	21261275	112	005720	1504609	161
1702.65608	21505894	80	005725	1508182	161
1702.65608	21505894	112	005726	1508184	161
1901.30702	82497194	73	005727	-	177
1901.30703	82497193	73	005730	1504608	161
1902.65200	3176546	80	005731	-	177
1902.65200	3176546	99	005732	-	177
1902.65200	3981924	80	005733	-	178
1902.65200	3981924	99	005734	-	178
1902.65201	3176545	80	005920	1350340	150
1902.65201	3176545	99	005930	1350339	150
1902.65201	3981923	80	005931	-	178
1902.65201	3981923	99	005932	-	178
1902.65202	3176542	99	009480	1498103	178
1902.65202	3176542	112	009490	1498102	178
1902.65202	3176542	123	011111	1350343	150
1902.65203	3176541	99	011112	-	178
1902.65203	3176541	112	011114	-	177
1902.65203	3176541	123	011115	-	177
2102.13080	1676400	80	011115	-	178
2102.13080	1676400	99	011211	1380819	161
2102.13080	1676400	112	011211	1380819	178
2102.13080	1676576	80	011211	1380819	179
2102.13080	1676576	99	011214	1412392	161
2102.13080	1676576	112	103.01929	1366736	153
2102.64080	1674918	81	103.01929	1401929	153
2102.64080	1674918	99	103.08292	1317538	138
2102.64080	1674918	112	103.43100	1543607	144
2402.44100	1619106	136	103.43101	1743177	144
2402.53100	20379348	81	103.43101	1743177	164
2402.53100	20379348	113	103.43101	1748086	144
2402.53100	20379348	123	103.43101	1748086	164
2402.53101	3981920	113	103.43102	1746586	145
2402.53101	8143670	113	103.43102	1751661	145
3002.00000	84429873	136	103.43102	1858803	145
3002.00001	-	78	103.43102	1904814	145
3002.00001	-	81	103.43102	2008861	145
3002.00001	-	99	103.43124	1366384	139
3002.00001	-	113	103.43124	1366384	153
3002.00001	-	123	103.43134	1366243	139
3002.00002	-	69	103.43134	1366243	154
3002.00002	-	73	103.43134	1366832	139
			103.43134	1366832	154
			103.43134	1870689	139
			103.43134	1870689	154
			103.43144	1371856	153
			103.43144	1397570	153
			103.43421	1302696	148
			103.43450	1334054	151
			103.45139	1459488	164
			103.45139	1743176	164
			103.45139	1748085	164
			103.45140	1466032	163
			103.45141	1466031	163
			103.45142	1459133	163
			103.45143	1459134	144
			103.45143	1459134	163
			103.45143	1880737	144
			103.45143	1880737	163
			103.45144	1459135	144
			103.45144	1459135	163
			103.45145	1538383	163
			103.45145	1755594	163

COS.SCA

COS.PEL ref.	SIMILAR ref.	PAG			
002999	1737413	174	103.43144	1397570	153
002999	2000390	174	103.43421	1302696	148
002999	2080828	174	103.43450	1334054	151
003006	1391144	159	103.45139	1459488	164
003006	1443884	159	103.45139	1743176	164
003006	1471599	159	103.45139	1748085	164
003092	-	161	103.45140	1466032	163
003120	-	147	103.45141	1466031	163
003120	-	161	103.45142	1459133	163
003120	-	177	103.45143	1459134	144
003120	-	188	103.45143	1459134	163
003120	-	193	103.45143	1880737	144
003120	-	205	103.45143	1880737	163
003123	-	161	103.45144	1459135	144
003123	-	177	103.45144	1459135	163
003123	-	188	103.45145	1538383	163
			103.45145	1755594	163



103.45145	1880736	163	103.48107	2324352	195
103.45146	1536807	145	103.48108	2329070	196
103.45146	1536807	164	103.48109	2324355	196
103.45147	1459141	145	103.48110	2324367	196
103.45147	1459141	164	103.48111	2324356	196
103.45148	1459142	145	103.48112	2305632	196
103.45148	1459142	164	103.48113	2324368	196
103.45149	1514524_5_6+1726328	164	103.48113	2584635	196
103.45150	1459145	164	103.48114	2324369	196
103.45151	1451246	165	103.48114	2584637	196
103.45151	1721731	165	103.48115	2310450	196
103.45151	1746585	165	103.48116	2329044	196
103.45151	1804628	165	103.48117	2329046	196
103.45152	1459146	144	103.48118	2614806	197
103.45152	1459146	164	103.48119	2614805	197
103.45153	1541484	173	103.48120	2542870	197
103.46142	1871667	165	103.48121	2502345	197
103.46143	1451527	165	103.48122	2286062	197
103.46144	1451528	165	103.48123	2392771	197
103.46145	1859174	180	103.48124	2324293	197
103.46145	1917216	180	103.48125	2324292	197
103.46146	1872158	180	103.48126	2324347	197
103.46147	1885932	181	103.48127	2324296	197
103.46148	1872160	182	103.48128	2324349	197
103.46149	1870592	180	103.48129	2324348	197
103.46150	1870593	180	103.48130	2507858	198
103.46151	1870594	180	103.48131	2507857	198
103.46152	1890176	182	103.48132	2183824	198
103.46152	1890787	182	103.48133	2183823	198
103.46153	1870597	182	103.48134	2365426	198
103.46154	1870598	181	103.48135	2365443	198
103.46155	1870599	181	103.48136	2535458	198
103.46156	1875846	182	103.71757	1371757	153
103.46157	1872159	182	103.71758	1371758	153
103.46158	1870596	181	103.83609	1383609	154
103.46159	1870595	181	103.97571	1397571	139
103.46160	1875843	182	103.97572	1401931	139
103.46160	1875858	182	103.97573	1371754	139
103.46161	1875847	183	203.08465	1335391	140
103.46162	1451271	145	203.08465	1335391	154
103.46162	1451271	183	203.08465	1408465	140
103.46163	1451270	145	203.08465	1408465	154
103.46163	1451270	183	203.08465	1485485	140
103.46164	1866913	145	203.08465	1485485	154
103.46164	1866913	183	203.08466	1335392	140
103.46165	1479758	165	203.08466	1335392	154
103.46166	1479759	165	203.08466	1408466	140
103.47100	1930792	181	203.08466	1408466	154
103.47101	1930793	181	203.08466	1485486	140
103.47102	1930794	181	203.08466	1485486	154
103.47103	1930800	183	203.08467	1364665	154
103.47104	1930805	181	203.08468	1364666	154
103.47105	1930806	182	203.08469	1324605	154
103.47106	1890728	183	203.08469	1429393	154
103.47107	1930799	182	203.08469	1517649	154
103.47108	1930811	183	203.08470	1324606	154
103.47109	1930812	183	203.08470	1429394	154
103.48100	2307679	195	203.08470	1517650	154
103.48101	2297701	195	203.13592	1313592	148
103.48102	2297703	195	203.13592	1313592	151
103.48103	2443019	195	203.13594	1313594	148
103.48104	2443020	195	203.13594	1313594	151
103.48105	2307678	195	203.25265	1325265	151
103.48106	2324353	195	203.25266	1325266	151

ALL ITEMS MENTIONED IN OUR CATALOGUE ARE NOT ORIGINAL PARTS BUT PERFECTLY INTERCHANGEABLE WITH THEM.

GOVERNING LEGISLATIONS FOR THE SALE OF OUR PRODUCTS DIFFER IN EACH COUNTRY.

INFRINGEMENTS, IF ANY, OF LOCAL LEGISLATIONS ARE RESPONSIBILITY OF THE RETAILER IN THE COUNTRY OF FINAL DISTRIBUTION.



203.42431	388169	148	203.48233	2304659	200
203.42432	388170	148	203.48234	2246834	200
203.42433	288177	148	203.48235	2443021	200
203.42434	288178	148	203.48236	2298022	200
203.44599	1357599	140	203.48237	2298045	201
203.44599	1357599	154	203.48237	2599549	201
203.44599	1357599	166	203.48238	2298046	201
203.44599	1357599	184	203.48238	2599550	201
203.44599	1357599	190	203.48239	2302630	201
203.44600	1357600	140	203.48240	2302631	201
203.44600	1357600	155	203.48241	1383858	201
203.44600	1357600	166	203.48241	2246819	201
203.44600	1357600	184	203.48242	2246819	201
203.44600	1357600	190	203.48243	1383858	201
203.45201	1431933	165	203.48243	2246818	201
203.45202	1431934	165	203.48244	2246818	201
203.45203	1431931	165	203.50419	350419	149
203.45204	1431932	165	203.50420	350420	149
203.45205	1947569	165	203.57601	1357602	140
203.45205	1947569	183	203.57601	1357602	155
203.45205	1947569	190	203.57601	1357602	166
203.45206	1947568	165	203.57601	1357602	184
203.45206	1947568	183	203.57601	1357602	190
203.45206	1947568	190	203.57601	1383858	140
203.46200	1540269	184	203.57601	1383858	155
203.46200	1540269	190	203.57601	1383858	166
203.46201	1540268	184	203.57601	1383858	184
203.46201	1540268	190	203.57601	1383858	190
203.46202	1805342	184	203.57602	1357602	140
203.46203	1442655	184	203.57602	1357602	155
203.46203	1805341	184	203.57602	1357602	166
203.48200	2297984	198	203.57602	1357602	184
203.48201	2297983	198	203.57602	1357602	191
203.48202	2403512	198	203.68651	1362708	140
203.48203	2403511	198	203.68651	1362708	154
203.48204	2297992	198	203.68651	1362708	165
203.48205	2297991	198	203.68651	2026618	140
203.48206	2297996	199	203.68651	2026618	154
203.48207	2297995	199	203.68651	2026618	165
203.48208	2297994	199	203.68651	2026620	140
203.48209	2297993	199	203.68651	2026620	154
203.48210	2246831	199	203.68651	2026620	165
203.48211	2246830	199	203.68652	1368652	140
203.48212	2304676	199	203.68652	1368652	154
203.48213	2304675	199	203.68652	1368652	165
203.48214	2304658	199	203.68652	2026619	140
203.48215	2304657	199	203.68652	2026619	154
203.48216	2403516	199	203.68652	2026619	165
203.48217	2403515	199	203.68652	2026621	140
203.48218	2297990	199	203.68652	2026621	154
203.48219	2297989	199	203.68652	2026621	165
203.48220	2297988	199	203.95275	1383858	140
203.48221	2297987	199	203.95275	1383858	155
203.48222	2403514	200	203.95275	1383858	166
203.48223	2403513	200	203.95275	1383858	184
203.48224	2297986	200	203.95275	1383858	191
203.48225	2297985	200	203.95275	1395276	140
203.48226	2304678	200	203.95275	1395276	155
203.48227	2304677	200	203.95275	1395276	166
203.48228	2304662	200	203.95275	1395276	184
203.48229	2304661	200	203.95275	1395276	191
203.48230	2297998	200	203.95276	1395276	141
203.48231	2297997	200	203.95276	1395276	155
203.48232	2304660	200	203.95276	1395276	166



203.95276	1395276	184	303.48106	2229102	202
203.95276	1395276	191	303.48106	2559305	202
203.95277	1357601	155	303.48107	2559306	202
203.95277	1357601	166	303.48108	2349687	202
203.95277	1357601	185	403.00001	330749	149
203.95277	1357601	191	403.03318	1303318	149
203.95278	1357601	155	403.24596	1324596	156
203.95278	1357601	166	403.24596	1400213	156
203.95278	1357601	185	403.24597	1324597	156
203.95278	1357601	191	403.24598	1324598	156
203.95278	1383858	155	403.24599	1395871	156
203.95278	1383858	166	403.24599	1482070	156
203.95278	1383858	185	403.24599	1499230	156
203.95278	1383858	191	403.29551	1329551	152
303.10057	1110057	151	403.29552	1329552	152
303.10058	1110058	151	403.45127	1495577	168
303.11050	1351194	141	403.45128	1495578	168
303.11050	1351194	155	403.45129	1431924	167
303.11050	1515194	141	403.45130	1504131	167
303.11050	1515194	155	403.45131	1431925	168
303.11051	1351193	141	403.45131	1853346	168
303.11051	1351193	155	403.45132	1431926	168
303.11051	1515195	141	403.45132	1853347	168
303.11051	1515195	155	403.45133	1439788	145
303.11052	1354594	141	403.45133	1439788	168
303.11052	1354594	156	403.45134	1439789	145
303.11053	1354593	141	403.45134	1439789	168
303.11053	1354593	156	403.45135	1523508	168
303.11054	1390074	141	403.45136	1523509	168
303.11054	1390074	156	403.45137	1422843	145
303.11055	1390075	141	403.45137	1422843	168
303.11055	1390075	156	403.45137	1731206	145
303.45240	1486648	167	403.45137	1731206	168
303.45240	1779121	167	403.45137	1763296	145
303.45241	1486647	167	403.45137	1763296	168
303.45241	1779120	167	403.45138	1853165	146
303.45242	1512424	167	403.45139	1853164	146
303.45243	1512423	167	403.45140	1548053	146
303.45244	1442654	167	403.46084	1865188	185
303.45245	1442653	167	403.46085	1884485	185
303.45246	1529886	167	403.46086	1884486	185
303.45247	1732322	167	403.46087	1884483	185
303.45248	1498180	167	403.46087	1884483	191
303.45248	1854228	167	403.46088	1884915	185
303.45249	1498179	167	403.46088	1884915	191
303.45249	1854227	167	403.46089	1884914	185
303.45250	1501343	167	403.46089	1884914	191
303.45250	1779119	167	403.46090	1865183	185
303.45251	1501342	167	403.46090	1865183	192
303.45251	1779118	167	403.46091	1865182	185
303.47240	1946924	191	403.46091	1865182	192
303.47241	1946923	191	403.46100	1923743	185
303.48100	2559304	201	403.46100	1923743	192
303.48100	2559310	201	403.46101	1923742	185
303.48101	2559303	201	403.46101	1923742	192
303.48101	2559309	201	403.46102	1865178	186
303.48102	2349684	202	403.46102	1865178	192
303.48102	2349686	202	403.46102	2126392	186
303.48103	2349683	202	403.46102	2126392	192
303.48103	2349685	202	403.46103	1885996	186
303.48104	2559298	202	403.46104	1923745	186
303.48104	2559302	202	403.46104	1923745	192
303.48105	2559297	202	403.46105	1923744	186
303.48105	2559301	202	403.46105	1923744	192

ALL ITEMS MENTIONED IN OUR CATALOGUE ARE NOT ORIGINAL PARTS BUT PERFECTLY INTERCHANGEABLE WITH THEM.

GOVERNING LEGISLATIONS FOR THE SALE OF OUR PRODUCTS DIFFER IN EACH COUNTRY.

INFRINGEMENTS, IF ANY, OF LOCAL LEGISLATIONS ARE RESPONSIBILITY OF THE RETAILER IN THE COUNTRY OF FINAL DISTRIBUTION.



403.46106	1865186	186	703.00001	316756	149
403.48090	2311419	202	703.45500	1355655	171
403.48091	2295948	202	703.45501	1539870	171
403.48092	2295950	202	703.45502	1539871	171
403.48093	2077928	202	703.45503	-	171
403.48094	2077927	203	703.47700	2058757	192
403.48095	2077926	203	703.47701	2117867	192
403.48096	2311420	203	703.47701	2117871	192
403.48097	2295953	203	703.47702	2117868	192
403.48098	2295955	203	703.47703	2117870	192
403.48099	2311423	203	803.46801	1788758	186
403.48100	2311427	203	803.46802	1788757	186
403.48101	2128511	203	803.96659	1496659	157
403.48102	2128512	203	803.96659	1496666	157
403.48103	2311424	203	903.23231	390303	150
403.48104	2311428	203	903.23232	390304	150
403.76832	1376832	141	903.23233	1370329	157
403.76832	1499231	141	903.23234	1370330	157
403.76832	1515190	141	903.23235	1386957	141
503.11111	296538	149	903.23236	1386958	141
503.22222	376243	149	903.23236	1537675	141
503.44001	1442705	168	903.43160	1543609	146
503.44001	1732776	168	903.43160	2165864	146
503.44001	1765985	168	903.43161	1543608	146
503.44002	1443864	168	903.43161	2165863	146
503.44002	1732778	168	903.43162	1496294	146
503.44002	1767265	168	903.43162	1856472	146
503.44003	-	169	903.43163	1496293	146
503.44004	-	169	903.43163	1856473	146
503.44005	-	169	903.45228	1495957	171
503.44006	-	169	903.45228	1495957	186
503.44007	-	169	903.45228	1749717	171
503.44008	-	169	903.45228	1749717	186
503.44009	1406627	169	903.45228	1798864	171
503.44010	1406634	169	903.45228	1798864	186
503.44011	1732782	169	903.45228	1856474	171
503.44011	1765809	169	903.45228	1856474	186
503.44012	1732783	169	903.45229	1495956	171
503.44012	1765808	169	903.45229	1495956	186
503.44013	1945731	169	903.45229	1749716	171
503.44014	1396542	169	903.45229	1749716	186
503.44015	1346683	169	903.45229	1798863	171
503.44016	1346684	169	903.45229	1798863	186
503.44017	1366141	169	903.45229	1856475	171
503.44018	1406628	169	903.45229	1856475	186
503.45003	-	170	903.45230	1538385	171
503.45004	-	170	903.45230	1538385	186
503.45005	-	170	903.45230	1751406	171
503.45006	-	170	903.45230	1751406	186
503.45007	-	170	903.45231	1538384	171
503.45008	-	170	903.45231	1538384	186
503.45009	1723518	170	903.45231	1751405	171
503.45010	1723519	170	903.45231	1751405	186
503.45011	1346380	170	903.47600	2055972	193
503.45012	1396530	170	903.47601	2055973	193
503.45013	1396529	170	903.47602	2162653	193
503.45014	1484080	156	903.47603	2162652	193
503.45014	1484080	170	903.47604	2126956	193
503.45015	1484076	170	903.47605	2126955	193
503.45016	1484079	156	903.48600	2230751	203
503.45016	1484079	171	903.48601	2230750	203
503.45017	1484078	156	903.48602	2230757	203
503.45017	1484078	171	903.48603	2230756	203
503.55555	316918	149	903.48604	2402042	204



903.48605	2402039	204	1003.00020	1457896	142
903.48606	2402035	204	1003.00020	1457896	158
903.48607	2402012	204	1003.00020	1725672	142
903.70100	1382728	157	1003.00020	1725672	158
903.70101	1382727	157	1003.00020	1742386	142
903.70102	1381566	157	1003.00020	1742386	158
903.70103	1381565	157	1003.00021	1482405	158
903.86959	1370107	141	1003.00021	1785531	158
903.86960	1370108	141	1003.00021	2093721	158
903.86961	1386959	141	1003.00022	1482404	158
903.86962	1386960	141	1003.00022	1785530	158
1003.00001	581076	150	1003.00022	2093720	158
1003.00003	1326523	152	1003.00023 (1523607 rinforzo)		142
1003.00004	1326524	152	1003.00023 (1523607 rinforzo)		158
1003.00005	391555	150	1003.00023	1358315	142
1003.00007	1383520	142	1003.00023	1358315	158
1003.00007	1383520	157	1003.00023	1457887	142
1003.00007	1383520	172	1003.00023	1457887	158
1003.00009	1381563	142	1003.00023	1725663	142
1003.00009	1381563	157	1003.00023	1725663	158
1003.00009	1440108	142	1003.00023	1742377	142
1003.00009	1440108	157	1003.00023	1742377	158
1003.00010	1381564	142	1003.00023	2054601	142
1003.00010	1381564	157	1003.00023	2054601	158
1003.00010	1440113	142	1003.00023	2057119	142
1003.00010	1440113	157	1003.00023	2057119	158
1003.00010	1726851	142	1003.00024 (1523608 rinforzo)		142
1003.00010	1726851	157	1003.00024 (1523608 rinforzo)		158
1003.00011	1366287	142	1003.00024	1358316	142
1003.00011	1366287	157	1003.00024	1358316	158
1003.00011	1383887	142	1003.00024	1457888	142
1003.00011	1383887	157	1003.00024	1457888	158
1003.00012	1366288	142	1003.00024	1725664	142
1003.00012	1366288	157	1003.00024	1725664	158
1003.00012	1383888	142	1003.00024	1742378	142
1003.00012	1383888	157	1003.00024	1742378	158
1003.00012	1393447	142	1003.00024	2054602	142
1003.00012	1393447	157	1003.00024	2054602	158
1003.00013	1381479	142	1003.00024	2057120	142
1003.00013	1381479	157	1003.00024	2057120	158
1003.00014	1381480	142	1003.00025	1440781	158
1003.00014	1381480	157	1003.00026	1440780	158
1003.00015	1390076	142	1003.00031	1362691	158
1003.00015	1390076	158	1003.00144	1383858	143
1003.00015	1535049	142	1003.00144	1383858	160
1003.00015	1535049	158	1003.00144	1383858	176
1003.00016	1351203	142	1003.00144	1383858	205
1003.00016	1351203	158	1003.43100	1889298	146
1003.00016	1535045	142	1003.43101	1889297	146
1003.00016	1535045	158	1003.45048	1535048	172
1003.00019 (1523607 rinforzo)		142	1003.45048	1805447	172
1003.00019 (1523607 rinforzo)		158	1003.45049	1535052	172
1003.00019	1400899	142	1003.45050	1535040	172
1003.00019	1400899	158	1003.45051	1535039	172
1003.00019	1457895	142	1003.45052	1523882	172
1003.00019	1457895	158	1003.45052	1786693	172
1003.00019	1725671	142	1003.45053	1523881	172
1003.00019	1725671	158	1003.45053	1786692	172
1003.00019	2054603	142	1003.45054	1425051	159
1003.00019	2054603	158	1003.45055	1425052	159
1003.00020 (1523608 rinforzo)		142	1003.45056	1721894	172
1003.00020 (1523608 rinforzo)		158	1003.45056	2054580	172
1003.00020	1400900	142	1003.45057	1721893	172
1003.00020	1400900	158	1003.45057	2054579	172

ALL ITEMS MENTIONED IN OUR CATALOGUE ARE NOT ORIGINAL PARTS BUT PERFECTLY INTERCHANGEABLE WITH THEM.

GOVERNING LEGISLATIONS FOR THE SALE OF OUR PRODUCTS DIFFER IN EACH COUNTRY.

INFRINGEMENTS, IF ANY, OF LOCAL LEGISLATIONS ARE RESPONSIBILITY OF THE RETAILER IN THE COUNTRY OF FINAL DISTRIBUTION.



1003.45058	1721892	172	1103.48901	2592644	205
1003.45058	1927258	172	1103.48902	2394401	205
1003.45058	2054582	172	1103.48902	2533983	205
1003.45059	1721891	172	1103.48903	2394400	205
1003.45059	1927257	172	1203.24241	388311	150
1003.45059	2054581	172	1203.24242	388312	150
1003.46102	1889300	172	1203.25251	388309	138
1003.46102	1889300	186	1403.09584	1309585	152
1003.46103	1889299	172	1403.09585	1309584	152
1003.46103	1889299	186	1403.46005	1346163	146
1003.46228	1779114	187	1403.46005	1346163	187
1003.46229	1779113	187	1403.46006	1346164	146
1003.46230	1942253	187	1403.46006	1346164	187
1003.46230	2054590	187	1500.00000	-	161
1003.46230	2476495	187	1500.00000	-	178
1003.46231	1942252	187	1500.00000	-	188
1003.46231	2054589	187	1500.00000	-	193
1003.46231	2476494	187	1500.00001	-	161
1003.46232	1927262	173	1500.00001	-	178
1003.46232	2054586	173	1500.00001	-	188
1003.46233	1927261	173	1500.00001	-	193
1003.46233	2054585	173	1503.45000	-	161
1003.46234	1927260	173	1503.45000	-	178
1003.46234	2054584	173	1503.45000	-	188
1003.46235	1927259	173	1503.45000	-	193
1003.46235	2054583	173	1503.45000	-	205
1003.46236	1725676	173	1503.45001	-	161
1003.46237	1725675	173	1503.45001	-	178
1003.46803	2196771	173	1503.45001	-	188
1003.46804	2182273	173	1503.45001	-	193
1003.46805	2141714	176	1503.45001	-	205
1003.48100	2341865	204	1503.45002	-	161
1003.48101	2360072	204	1503.45002	-	178
1003.48102	2492752	204	1503.45002	-	188
1003.48103	2492751	204	1503.45002	-	194
1003.48108	2234214	204	1503.45002	-	206
1003.48109	2226746	204	1503.45003	-	161
1003.48110	2226744	204	1503.45003	-	178
1103.00831	1300831	150	1503.45003	-	188
1103.00831	1300832	150	1503.45003	-	194
1103.24599	1324599	143	1503.45003	-	206
1103.24599	1324599	159	1503.45005	-	162
1103.24599	1543634	143	1503.45005	-	178
1103.24599	1543634	159	1503.45005	-	188
1103.24600	1324600	143	1503.45005	-	194
1103.24600	1324600	159	1503.45005	-	206
1103.24600	1543635	143	1503.45006	1756751	147
1103.24600	1543635	159	1503.45006	1756751	162
1103.39395	393356	152	1503.45006	1756751	178
1103.39396	393357	152	1503.45006	1756751	189
1103.45530	1431921	173	1503.45006	1756751	206
1103.45530	1790007	173	1503.45006	2021575	147
1103.45530	1936675	173	1503.45006	2021575	162
1103.45531	1431920	173	1503.45006	2021575	178
1103.45531	1790006	173	1503.45006	2021575	189
1103.45531	1936674	173	1503.45006	2021575	206
1103.45532	1431923	173	1503.45006	2129987	147
1103.45533	1431922	173	1503.45006	2129987	162
1103.45533	2124015	173	1503.45006	2129987	178
1103.45534	1438558	174	1503.45006	2129987	189
1103.45534	1727992	174	1503.45006	2129987	206
1103.45535	1438557	174	1503.45007	1756754	147
1103.45535	1727991	174	1503.45007	1756754	162
1103.48900	2592645	205	1503.45007	1756754	178



1503.45007	1756754	189	1503.45102	1784670	147
1503.45007	1756754	206	1503.45102	1784670	147
1503.45007	2021579	147	1503.45102	1784670	162
1503.45007	2021579	162	1503.45102	1784670	162
1503.45007	2021579	178	1503.45102	1784670	178
1503.45007	2021579	189	1503.45102	1784670	179
1503.45007	2021579	206	1503.45102	1784670	189
1503.45007	2129985	147	1503.45102	1784670	189
1503.45007	2129985	162	1503.45102	1784670	206
1503.45007	2129985	178	1503.45102	1784670	206
1503.45007	2129985	189	1503.45102	2129991	147
1503.45007	2129985	206	1503.45102	2129991	147
1503.45008	1791369	147	1503.45102	2129991	162
1503.45008	1791369	162	1503.45102	2129991	162
1503.45008	1791369	179	1503.45102	2129991	178
1503.45008	1791369	189	1503.45102	2129991	179
1503.45008	1791369	206	1503.45102	2129991	189
1503.45008	2021576	147	1503.45102	2129991	189
1503.45008	2021576	162	1503.45102	2129991	206
1503.45008	2021576	179	1503.45102	2129991	206
1503.45008	2021576	189	1503.45103	1784669	147
1503.45008	2021576	206	1503.45103	1784669	147
1503.45008	2129988	147	1503.45103	1784669	162
1503.45008	2129988	162	1503.45103	1784669	162
1503.45008	2129988	179	1503.45103	1784669	178
1503.45008	2129988	189	1503.45103	1784669	179
1503.45008	2129988	206	1503.45103	1784669	189
1503.45009	2021578	147	1503.45103	1784669	189
1503.45009	2021578	162	1503.45103	1784669	206
1503.45009	2021578	179	1503.45103	1784669	206
1503.45009	2021578	189	1503.45103	2129992	147
1503.45009	2021578	206	1503.45103	2129992	147
1503.45009	2129986	147	1503.45103	2129992	162
1503.45009	2129986	162	1503.45103	2129992	162
1503.45009	2129986	179	1503.45103	2129992	178
1503.45009	2129986	189	1503.45103	2129992	179
1503.45009	2129986	206	1503.45103	2129992	189
1503.45010	1792374	179	1503.45103	2129992	189
1503.45011	1792375	179	1503.45103	2129992	206
1503.45100	-	161	1503.45103	2129992	206
1503.45100	-	161	1603.13073	1308473	150
1503.45100	-	178	1603.13074	1308474	150
1503.45100	-	178	1603.22991	1358831	160
1503.45100	-	188	1603.22991	1400207	160
1503.45100	-	188	1603.22991	1422991	160
1503.45100	-	193	1603.22991	1529070	160
1503.45100	-	194	1603.22992	1358832	160
1503.45100	-	205	1603.22992	1400208	160
1503.45100	-	206	1603.22992	1422992	160
1503.45101	-	161	1603.22992	1529071	160
1503.45101	-	161	1603.44707	1362707	159
1503.45101	-	162	1603.44707	1362707	174
1503.45101	-	178	1603.44707	2052117	159
1503.45101	-	178	1603.44707	2052117	174
1503.45101	-	178	1603.45520	1446354	175
1503.45101	-	188	1603.45520	1852570	175
1503.45101	-	188	1603.45520	2248114	175
1503.45101	-	188	1603.45521	1446353	175
1503.45101	-	193	1603.45521	1852569	175
1503.45101	-	194	1603.45521	2248103	175
1503.45101	-	194	1603.45522	1446356	175
1503.45101	-	205	1603.45522	1852573	175
1503.45101	-	206	1603.45522	2080689	175
1503.45101	-	206	1603.45523	1446355	175

ALL ITEMS MENTIONED IN OUR CATALOGUE ARE NOT ORIGINAL PARTS BUT PERFECTLY INTERCHANGEABLE WITH THEM.

GOVERNING LEGISLATIONS FOR THE SALE OF OUR PRODUCTS DIFFER IN EACH COUNTRY.

INFRINGEMENTS, IF ANY, OF LOCAL LEGISLATIONS ARE RESPONSIBILITY OF THE RETAILER IN THE COUNTRY OF FINAL DISTRIBUTION.



1603.45523	1852572	175	1703.20074	1306976	152
1603.45523	2080688	175	1703.20075	1306975	152
1603.45524	1747981	174	1703.30220	1423018	160
1603.45524	2442689	174	1703.30220	1423018	175
1603.45525	1770301	174	1703.30220	1488410	160
1603.45525	2052103	174	1703.30220	1488410	175
1603.45526	1798980	174	1703.30220	1544331	160
1603.45526	1910437	174	1703.30220	1544331	175
1603.45527	1760551	175	1703.30220	2005370	160
1603.45527	1892322	175	1703.30220	2005370	175
1603.45527	1900349	175	1703.30220	2145648	160
1603.45527	2442629	175	1703.30220	2145648	175
1603.45528	1760554	175	1703.30220	2371255	160
1603.45528	1892324	175	1703.30220	2371255	175
1603.45528	1900351	175	1703.30221	1423017	160
1603.45528	2442631	175	1703.30221	1423017	175
1603.45529	1549814	175	1703.30221	1488409	160
1603.45530	1549815	175	1703.30221	1488409	175
1603.45531	1949900	174	1703.30221	1544330	160
1603.45532	1931614	174	1703.30221	1544330	175
1603.45532	2031055	174	1703.30221	2005369	160
1603.45532	2127432	174	1703.30221	2005369	175
1603.45533	1931613	174	1703.30221	2145647	160
1603.45533	2031054	174	1703.30221	2145647	175
1603.45533	2127431	174	1703.30221	2371254	160
1603.45534	2241544	175	1703.30221	2371254	175
1603.45534	2442637	175	1703.30222	1485072	160
1603.45535	1928063	175	1703.30222	1485072	175
1603.45535	1928063	187	1703.30222	581025	160
1603.45535	1928063	193	1703.30222	581025	175
1603.45535	2083830	175	1703.30223	1406223	143
1603.45535	2083830	187	1703.30223	1789305	143
1603.45535	2083830	193	1703.30223	1902975	143
1603.46500	2241827	187	1703.30224	1406224	143
1603.46501	2241826	187	1703.30224	1789306	143
1603.46502	2241829	187	1703.30224	1902976	143
1603.46502	2416137	187	1703.30225	1426927	143
1603.46503	2241828	187	1703.30225	1857591	143
1603.46503	2416136	187	1703.30225	1930649	143
1603.48600	2379894	205	1703.30226	1767631	143
1603.48600	2655843	205	1703.30227	1902355	176
1603.48601	2379890	205	1703.30228	1902356	176
1603.48601	2655842	205	1703.30229	1800467	143
1603.48602	2379893	205	1703.30230	1800468	143
1603.48602	2655841	205	1703.30231	1789311	143
1603.48603	2373889	205	1703.30231	1867654	143
1603.48603	2655840	205	1703.30232	1789312	143
1603.48606	2334728	205	1703.30232	1867655	143
1603.48607	2334727	205	1703.30233	1789317	176
1603.67001	1431257	160	1703.30233	1867658	176
1603.67001	1446587	160	1703.30234	1789318	176
1603.67001	1467000	160	1703.30234	1867659	176
1603.67001	1732509	160	1903.14350	1406614	150
1603.67002	1431256	160	1903.14351	1406613	150
1603.67002	1446588	160	1903.45300	-	176
1603.67002	1467003	160	1903.45301	-	176
1603.67002	1732510	160	1903.45302	1366848	160
1603.67003	1385402	159	1903.45302	1366848	176
1603.67004	1385403	159	1903.45303	1366847	160
1603.85411	1349783	159	1903.45303	1366847	176
1603.85411	1385410	159	1903.45304	1366850	160
1603.85412	1732515	159	1903.45304	1366850	176
1603.87150	1349784	159	1903.45304	1442295	160
1603.87150	1387155	159	1903.45304	1442295	176



1903.45305	1366849	160	011111	1272653	239
1903.45305	1366849	176	011111	1272653	249
1903.45305	1442294	160	011111	1272653	250
1903.45305	1442294	176	011112	-	259
2103.44080	1370707	160	104.00004	1400004	240
2103.44080	1385966	160	104.09400	1309400	240
2103.44080	1421090	160	104.09401	1309401	240
2103.44080	1511775	160	104.10501	1635802	251
2103.44080	1765735	160	104.10501	1954514	251
2103.44080	1855164	160	104.10600	1886591	261
2103.44080	1894478	160	104.10600	2046502	261
2403.43100	1481372	146	104.10600	2048272	261
2403.43100	1481372	187	104.10601	1857653	230
2403.43100	2031866	146	104.10601	1857653	261
2403.43100	2031866	187	104.10602	1857654	230
2403.43101	1481373	146	104.10602	1857654	261
2403.43101	1481373	187	104.10603	2104217	261
2403.43101	2031868	146	104.10604	1887709	261
2403.43101	2031868	187	104.10604	1936285	261
2403.44100	1306492	147	104.12789	1312789	240
2403.44100	1306492	176	104.55008	1700387	208
2403.44101	1374642	147	104.55008	1700802	208
2403.44101	1374642	177	104.55009	1400506	208
2403.45100	1435542	177	104.55010	1400501	208
2403.45100	1435542	188	104.55010	1405008	208
2403.45101	2031872	177	104.55011	1401828	208
2403.45101	2031872	188	104.55011	1405015	208
3003.00000	-	177	104.55012	1700801	208
			104.55012	1701375	208
			104.56010	1707123	214
			104.56011	1706968	217
			104.56011	1706969	217
			104.56012	1706953	214
			104.64100	1886592	230
			104.64100	2046503	230
			104.64101	1877261	230
			104.64101	1956193	230
			104.64102	1893917	230
			104.64102	2144204	230
			104.72534	1372534	222
			104.72534	1747244	222
			104.72535	1372535	222
			104.72536	1375876	222
			104.72536	1640320	222
			104.72536	1657685	222
			104.80059	280059	236
			201.28252	1389563	241
			201.28252	1389563	251
			204.10529	1875551	230
			204.10529	1875551	261
			204.10529	1875552	230
			204.10529	1875552	261
			204.10529	1927847	230
			204.10529	1927847	261
			204.10530	1875551	231
			204.10530	1875551	262
			204.10530	1875552	231
			204.10530	1875552	262
			204.10531	1875553	231
			204.10531	1875553	262
			204.10531	1875563	231
			204.10531	1875563	262
			204.10531	1892197	231
			204.10531	1892197	262

COS.DA

COS.PEL ref.	SIMILAR ref.	PAG			
003001	1303892	211	104.56012	1706953	214
003001	1303892	227	104.64100	1886592	230
003001	1303892	247	104.64100	2046503	230
003001	1303892	257	104.64101	1877261	230
003001	1329718	211	104.64101	1956193	230
003001	1329718	227	104.64102	1893917	230
003001	1329718	247	104.64102	2144204	230
003001	1329718	257	104.72534	1372534	222
003003	1653605	227	104.72534	1747244	222
003092	1973239	234	104.72535	1372535	222
003092	1973239	269	104.72536	1375876	222
003119	-	234	104.72536	1640320	222
003119	-	249	104.72536	1657685	222
003119	-	259	104.80059	280059	236
003119	-	269	201.28252	1389563	241
003120	-	212	201.28252	1389563	251
003120	-	229	204.10529	1875551	230
003121	-	212	204.10529	1875551	261
003122	-	212	204.10529	1875552	230
003122	-	229	204.10529	1875552	261
003122	-	249	204.10529	1927847	230
003122	-	259	204.10529	1927847	261
003123	-	229	204.10530	1875551	231
003123	-	234	204.10530	1875551	262
003123	-	249	204.10530	1875552	231
005900	1284212	239	204.10530	1875552	262
005910	1284211	239	204.10531	1875553	231
006120	1625986	249	204.10531	1875553	262
006130	1625985	249	204.10531	1875563	231
006132	-	259	204.10531	1875563	262
006133	-	259	204.10531	1892197	231
			204.10531	1892197	262

ALL ITEMS MENTIONED IN OUR CATALOGUE ARE NOT ORIGINAL PARTS BUT PERFECTLY INTERCHANGEABLE WITH THEM.

GOVERNING LEGISLATIONS FOR THE SALE OF OUR PRODUCTS DIFFER IN EACH COUNTRY.

INFRINGEMENTS, IF ANY, OF LOCAL LEGISLATIONS ARE RESPONSIBILITY OF THE RETAILER IN THE COUNTRY OF FINAL DISTRIBUTION.



204.10531	1936302 Antispray	231	204.28934	1328934	223
204.10531	1936302 Antispray	262	204.28934	1328934	236
204.10531	2120351	231	204.28934	1328934	241
204.10531	2120351	262	204.28934	1328934	251
204.10531	2120359	231	204.28935	1328935	220
204.10531	2120359	262	204.28935	1328935	223
204.10531	2120361	231	204.28935	1328935	237
204.10531	2120361	262	204.28935	1328935	241
204.10532	1875554	231	204.28935	1328935	252
204.10532	1875554	262	204.28936	1659811	241
204.10532	1875564	231	204.28936	1659811	252
204.10532	1875564	262	204.28937	1340450	241
204.10532	1892198	231	204.28937	1340450	252
204.10532	1892198	262	204.28937	1659811	241
204.10532	1936302 Antispray	231	204.28937	1659811	252
204.10532	1936302 Antispray	262	204.37809	1437809	222
204.10532	2120352	231	204.37809	1656917	222
204.10532	2120352	262	204.37809	1893901	222
204.10532	2120360	231	204.37810	1363817	222
204.10532	2120360	262	204.37810	1437810	222
204.10532	2120362	231	204.37810	1656918	222
204.10532	2120362	262	204.37810	1656977	222
204.10533	1875549	231	204.37810	1893902	222
204.10533	1875549	262	204.55020	1405250	209
204.10534	1875550	231	204.55020	1405250	214
204.10534	1875550	262	204.55020	1408232	209
204.10535	1875567	231	204.55020	1408232	214
204.10535	1875567	262	204.55021	1405247	209
204.10536	1892246	231	204.55021	1405247	214
204.10536	1892246	262	204.55021	1408227	209
204.10537	1892245	231	204.55021	1408227	214
204.10537	1892245	262	204.55022	1400636	209
204.10540	1936302	231	204.55022	1404997	209
204.10540	1936302	262	204.55022	1701040	209
204.10541	1892248	231	204.55023	1400637	209
204.10541	1892248	262	204.55023	1404998	209
204.10620	1835024	262	204.55023	1701039	209
204.10620	1861673	262	204.69437	1389296	222
204.10621	1835023	262	204.69437	1389296	240
204.10621	1861672	262	204.69437	1659253	222
204.10622	1835028	263	204.69437	1659253	240
204.10622	1843493	263	204.69438	1389297	222
204.10623	1835027	263	204.69438	1389297	240
204.10623	1843492	263	204.69438	1659254	222
204.10624	1835032	263	204.69438	1659254	240
204.10625	1835031	263	204.85487	085487	236
204.10626	1835065	263	204.85487	1227146	236
204.10627	1835066	263	204.85488	085488	236
204.28932	1328934	220	204.85488	1227147	236
204.28932	1328934	223	204.91172	1291173	241
204.28932	1328934	236	204.91172	1656912	241
204.28932	1328934	241	204.91172	1656924	241
204.28932	1328934	251	204.91172	1809266	241
204.28933	1328935	220	204.91173	1291172	241
204.28933	1328935	223	204.91173	1656911	241
204.28933	1328935	236	204.91173	1656923	241
204.28933	1328935	241	204.91173	1809265	241
204.28933	1328935	251	304.10510	1642683	252
204.28933	1340450	220	304.10510	1695235	252
204.28933	1340450	223	304.10511	1642682	252
204.28933	1340450	236	304.10511	1695234	252
204.28933	1340450	241	304.10512	-	252
204.28933	1340450	251	304.10513	-	252
204.28934	1328934	220	304.10514	-	252



304.10515	-	252	404.10691	1826510	264
304.10516	1796245	252	404.10692	1825434	264
304.10516	1836305	252	404.10692	1861983	264
304.10517	1796244	252	404.10693	1869588	264
304.10517	1836304	252	404.10693	1953385	264
304.10610	1798462	263	404.17126	1317126	242
304.10610	1948244	263	404.27140	1300041	242
304.10611	1798461	263	404.27140	1427140	242
304.10611	1948243	263	404.46301	1246301	221
304.10612	1828856	263	404.55089	1405032	209
304.10613	1828855	263	404.55089	1405767	209
304.10614	1798462	263	404.55090	1405027	209
304.10614	1948244	263	404.55090	1405766	209
304.10615	1798461	263	404.55091	1401824	209
304.10615	1948243	263	404.55091	1405030	209
304.10616	1828856	263	404.55091	1405880	209
304.10617	1828855	263	404.55092	1405031	209
304.55030	1405244	209	404.55092	1405881	209
304.55030	1405263	209	404.55092	1700877	209
304.55030	1405991	209	404.55093	1400503	209
304.55031	1405243	209	404.55093	1405011	209
304.55031	1405262	209	404.55094	1400502	209
304.55031	1405990	209	404.55094	1405010	209
304.56050	1707006	217	404.56099	1706972	214
304.56050	1707973	217	404.56099	1706972	217
304.56051	1707007	217	404.56099	1706976	214
304.56051	1708932	217	404.56099	1706976	217
304.64100	1440245	223	404.56100	1706904	214
304.64101	1440244	223	404.56100	1706904	217
304.64200	1881345	231	404.56100	1706973	214
304.64200	1952792	231	404.56100	1706973	217
304.64201	1881344	231	404.56101	1706986	215
304.64201	1952791	231	404.56101	1706986	217
304.64202	1881347	232	404.56102	1706987	215
304.64203	1881346	232	404.56102	1706987	217
304.64796	1440243	223	404.56103	964275	215
304.64797	1440242	223	404.56103	964275	218
304.64798	1364799	223	404.63375	1363375	223
304.64798	1695229	223	404.63375	1656562	223
304.64798	1911155	223	404.63375	1656563	223
304.64799	1364798	223	404.63375	1825005	223
304.64799	1695228	223	404.63375	1826226	223
304.64799	1911154	223	404.63375	1852685	223
304.81150	081150	237	404.64090	1876631	232
304.81151	081140	237	404.64090	1933253	232
304.84096	084097	220	404.81110	081110	237
304.84096	1297700	220	404.85510	085510	237
304.84097	084096	220	404.85510	085511	237
304.84097	1297699	220	404.90191	1290191	242
304.95732	1295735	242	404.95090	-	242
304.95735	1295732	242	404.96755	096755	237
304.95736	-	242	404.96756	096756	237
304.95737	-	242	501.30418	1409962	209
404.10538	1634640	252	501.30418	1526649	209
404.10538	1826225	252	501.31505	1700303	210
404.10539	1634640	253	501.31505	1700303	215
404.10539	1826225	253	501.31505	1700303	218
404.10540	1634640	253	501.31506	1700306	210
404.10540	1825008	253	501.31506	1700306	215
404.10540	1826225	253	501.31506	1700306	218
404.10541	0948779	242	501.31506	1704604	210
404.10541	0948779	253	501.31506	1704604	215
404.10690	1869588	263	501.31506	1704604	218
404.10690	1953385	263	501.31507	1700265	210

ALL ITEMS MENTIONED IN OUR CATALOGUE ARE NOT ORIGINAL PARTS BUT PERFECTLY INTERCHANGEABLE WITH THEM.

GOVERNING LEGISLATIONS FOR THE SALE OF OUR PRODUCTS DIFFER IN EACH COUNTRY.

INFRINGEMENTS, IF ANY, OF LOCAL LEGISLATIONS ARE RESPONSIBILITY OF THE RETAILER IN THE COUNTRY OF FINAL DISTRIBUTION.



501.31507	1700265	215	504.10542	1684042	254
501.31507	1700265	218	504.10542	1816912	254
501.31508	1700269	210	504.10543	1684038	254
501.31508	1700269	215	504.10543	1816910	254
501.31508	1700269	218	504.10544	1684046	254
501.31508	1704605	210	504.10544	1816914	254
501.31508	1704605	215	504.10545	1425124	254
501.31508	1704605	218	504.10545	1614022	254
501.31509	1736954	210	504.10545	1949305	254
501.31509	1736954	215	504.10630	1940341	232
501.31509	1736954	218	504.10630	1940341	264
501.31510	1736953	210	504.10631	1940342	264
501.31510	1736953	215	504.10638	1940334	264
501.31510	1736953	218	504.10639	1940335	264
501.31511	1733892	210	504.63500	1952146	224
501.31511	1733892	215	504.63501	1952141	224
501.31511	1733892	218	504.72500	1614021	224
501.31512	1733893	210	504.72500	1949304	224
501.31512	1733893	215	504.99026	1610190	224
501.31512	1733893	218	504.99026	1610190	243
501.53500	1404871	210	504.99027	1610184	224
501.53500	1405295	210	504.99027	1610184	243
501.53500	1805712	210	504.99028	1610187	225
501.53501	1796324	210	504.99028	1610187	243
501.53501	1796324	224	504.99028	1670877	225
501.53501	1796324	242	504.99028	1670877	243
501.89373	1610182	224	604.00095	1311329	243
501.89373	1610182	243	704.10500	1308687	243
501.89373	1610191	224	704.10500	1308687	255
501.89373	1610191	243	704.10501	1300557	243
502.44444	1305462	237	704.10501	1300557	255
502.99011	1353295	237	704.10502	1651597	243
502.99013	1232015	237	704.10502	1651597	255
502.99017	0699854	238	704.55100	1742638	210
504.10530	1689348	224	704.55101	1405233	210
504.10530	1689348	232	704.55101	1742640	210
504.10530	1689348	253	704.63400	1298974	225
504.10530	1689348	264	704.63400	1312864	225
504.10530	1812862	224	704.63400	1312868	225
504.10530	1812862	232	804.02007	1328945	244
504.10530	1812862	253	804.02007	1363278	244
504.10530	1812862	264	804.10593	1658401	255
504.10531	1689347	224	804.10598	1672846	255
504.10531	1689347	232	804.10598	1798782	255
504.10531	1689347	253	804.10599	1684676	255
504.10531	1817860	224	904.00011	1400011	244
504.10531	1817860	232	904.00011	1400011	255
504.10531	1817860	253	904.00012	1400012	244
504.10532	1685330	253	904.00012	1400012	255
504.10532	1685330	264	904.00013	1400013	244
504.10533	1685331	253	904.00013	1400013	255
504.10534	1644325	253	904.00014	1400014	244
504.10534	1659248	253	904.00014	1400014	255
504.10535	1644326	254	904.10680	1835710	265
504.10535	1659249	254	904.10680	1835764	265
504.10536	1644323	254	904.10680	2114705	265
504.10537	1644324	254	904.10681	1835709	265
504.10538	1685325	254	904.10681	1835763	265
504.10538	1830562	254	904.10681	2114704	265
504.10539	1685324	254	904.10682	1835710	265
504.10539	1812867	254	904.10682	2114705	265
504.10540	1644303	254	904.10683	1835710	265
504.10541	1781902	254	904.10683	2114705	265
504.10541	1808561	254	904.55180	1400711	211



904.55180	1405231	211	1004.10024	1399185	225
904.55181	1400710	211	1004.10024	1627646	225
904.55181	1405230	211	1004.10025	1399833	225
904.56170	1706920	215	1004.10025	1627643	225
904.56170	1706920	218	1004.10026	1438577	226
904.56170	1709694	215	1004.10026	1696663	226
904.56170	1709694	218	1004.10026	1699473	226
904.56171	1706919	215	1004.10027	1438576	226
904.56171	1706919	218	1004.10027	1696660	226
904.56171	1709693	215	1004.10027	1696662	226
904.56171	1709693	218	1004.10027	1699472	226
904.64080	1844276	232	1004.10028	0750899	226
904.64081	1844275	232	1004.10530	1927847	269
904.72000	1372533	225	1004.10531	-	265
904.72001	1372532	225	1004.10533	-	265
904.72002	1362871	225	1004.10550	1641631	255
904.72003	1362870	225	1004.10551	1641630	255
904.80062	1302984	238	1004.10552	1662370	256
904.80062	1302984	244	1004.10552	1674548	256
904.80062	280062	238	1004.10553	1667520	256
904.80062	280062	244	1004.10553	1693664	256
904.80063	1302983	238	1004.10554	1667521	256
904.80063	1302983	244	1004.10554	1693665	256
904.80063	280063	238	1004.10555	1603386	226
904.80063	280063	244	1004.10555	1603386	246
904.99417	1299417	238	1004.10555	1603386	256
904.99417	1299417	244	1004.10555	1732653	226
904.99418	1299418	238	1004.10555	1732653	246
904.99418	1299418	244	1004.10555	1732653	256
1001.00001	1340450	228	1004.10555	1745335	226
1001.00001	1340450	238	1004.10555	1745335	246
1001.00001	1340450	248	1004.10555	1745335	256
1001.00001	1340450	259	1004.10556	1371225	265
1004.00002	1319679	244	1004.10556	1371226	265
1004.00003	1319678	244	1004.10557	1371224	265
1004.00004	1329524	244	1004.10558	1893586	265
1004.00004	1450977	244	1004.10559	1893585	265
1004.00005	1329523	244	1004.10620	1945946	266
1004.00005	1450976	244	1004.10621	1945945	266
1004.00006	1303944	244	1004.10622	1945944	266
1004.00006	1347132	244	1004.10650	1798464	266
1004.00007	1303943	244	1004.10650	1945872	266
1004.00007	1347131	244	1004.10651	1798463	266
1004.00008	1445564	245	1004.10651	1945871	266
1004.00008	1605933	245	1004.10652	1798460	266
1004.00009	1445563	245	1004.10652	1948152	266
1004.00009	1605932	245	1004.10653	1798459	266
1004.00010	0962643	245	1004.10653	1948151	266
1004.00011	2050044	245	1004.10654	1895878	232
1004.00012	1610454	245	1004.10654	1895878	266
1004.00013	0673143	245	1004.10654	1922986	232
1004.00014	0673144	245	1004.10654	1922986	266
1004.00015	1629036	245	1004.10655	1895877	232
1004.00016	1629046	245	1004.10655	1895877	266
1004.00017	1629045	246	1004.10655	1922985	232
1004.10019	1667885	225	1004.10655	1922985	266
1004.10019	1693114	225	1004.55000	1405241	211
1004.10020	1366254	225	1004.55000	1405241	218
1004.10020	1368837	225	1004.55001	1404308	211
1004.10020	1638481	225	1004.55001	1404308	215
1004.10021	1366253	225	1004.55002	1401819	211
1004.10021	1368836	225	1004.55003	1401818	211
1004.10021	1638480	225	1006.33602	1649588	221
1004.10022	0962101	225	1006.33602	1649588	226

ALL ITEMS MENTIONED IN OUR CATALOGUE ARE NOT ORIGINAL PARTS BUT PERFECTLY INTERCHANGEABLE WITH THEM.

GOVERNING LEGISLATIONS FOR THE SALE OF OUR PRODUCTS DIFFER IN EACH COUNTRY.

INFRINGEMENTS, IF ANY, OF LOCAL LEGISLATIONS ARE RESPONSIBILITY OF THE RETAILER IN THE COUNTRY OF FINAL DISTRIBUTION.



1006.33602	1649588	238	1104.63374	1363374	226
1006.33602	1649588	246	1104.63374	1658382	226
1006.33602	1649588	256	1104.63375	1372801	226
1104.10516	1649364	256	1104.63376	1372802	226
1104.10516	1683722	256	1104.63377	1435754	226
1104.10516	1973360	256	1104.63377	1658383	226
1104.10517	1649363	256	1104.63378	1435755	226
1104.10517	1683722	256	1104.63378	1658384	226
1104.10517	1973359	256	1104.64600	1881351	233
1104.10518	1649364	256	1104.64601	1881350	233
1104.10518	1683722	256	1104.64602	1848558	233
1104.10518	1973360	256	1104.64603	1848557	233
1104.10519	1649363	256	1104.64604	1837655	232
1104.10519	1683722	256	1104.64605	1837654	232
1104.10519	1973359	256	1104.64606	1887135	233
1104.10520	1649364	256	1104.64607	1887134	233
1104.10520	1683722	256	1104.64608	1837642	233
1104.10520	1973360	256	1104.64609	1837641	233
1104.10521	1649363	256	1104.96757	096757	238
1104.10521	1683721	256	1104.96758	096758	238
1104.10521	1973359	256	1104.99046	1308795	246
1104.10522	1684872	256	1104.99047	1308794	246
1104.10522	1695110	256	1104.99048	1294949	246
1104.10523	1684871	256	1104.99048	1911163	246
1104.10523	1695109	256	1104.99049	1294948	246
1104.10612	2107373	266	1104.99049	1911162	246
1104.10613	2107372	266	1104.99050	1398285	246
1104.10614	1798449	266	1104.99050	1398285	257
1104.10615	1798448	266	1104.99050	1738627	246
1104.10616	1798458	266	1104.99050	1738627	257
1104.10616	1922031	266	1104.99051	1398284	246
1104.10616	2011377	266	1104.99051	1398284	257
1104.10617	1798457	266	1104.99051	1738626	246
1104.10617	1922030	266	1104.99051	1738626	257
1104.10617	2011376	266	1104.99052	1396937	246
1104.10618	1861950	267	1104.99052	1396937	257
1104.10619	1861949	267	1104.99052	1439349	246
1104.10620	1798472	267	1104.99052	1439349	257
1104.10620	1880379	267	1104.99052	1862946	246
1104.10621	1798471	267	1104.99052	1862946	257
1104.10621	1880378	267	1104.99053	1396936	246
1104.10622	1880398	267	1104.99053	1396936	257
1104.10623	1880397	267	1104.99053	1439348	246
1104.10624	2033876	267	1104.99053	1439348	257
1104.10625	2033875	267	1104.99053	1862945	246
1104.10626	1798472	267	1104.99053	1862945	257
1104.10626	1880379	267	1104.99054	1398285	257
1104.10627	1798471	267	1104.99054	1738627	257
1104.10627	1880378	267	1104.99055	1398284	257
1104.10628	1861950	267	1104.99055	1738626	257
1104.10629	1861949	267	1104.99056	1425577	246
1104.10630	2033876	267	1104.99056	1425577	257
1104.10631	2033875	267	1104.99056	1650329	246
1104.55060	1400505	211	1104.99056	1650329	257
1104.55060	1407464	211	1104.99057	1398284	257
1104.55061	1400504	211	1104.99057	1738626	257
1104.55061	1407465	211	1104.99058	1398285	257
1104.56030	1706985	216	1104.99058	1738627	257
1104.56030	1706985	218	1404.10670	1835171	267
1104.56031	1706984	216	1404.10670	2041670	267
1104.56031	1706984	218	1404.10670	2046359	267
1104.56032	1707002	216	1404.10671	1835170	267
1104.56033	1707003	216	1404.10671	2041669	267
1104.63373	1363373	226	1404.10671	2046358	267



1404.10672	1835171	268	1504.10608	-	270
1404.10672	2041670	268	1504.10609	-	250
1404.10672	2046359	268	1504.10609	-	260
1404.10673	1835170	268	1504.10609	-	270
1404.10673	2041669	268	1504.10610	-	250
1404.10673	2046358	268	1504.10610	-	260
1404.95611	1450155	226	1504.10610	-	270
1404.95611	1836599	226	1504.10680	1914691	234
1404.95612	1450156	226	1504.10680	1914691	234
1404.95612	1836600	226	1504.10680	1914691	234
1404.95612	1940527	226	1504.10680	1914691	235
1404.95613	-	227	1504.10680	1914691	269
1404.95614	-	227	1504.10680	1914691	269
1404.95619	1295619	247	1504.10680	1914691	269
1404.95619	1295619	257	1504.10680	1914691	269
1404.95620	1295620	247	1504.10681	1914690	234
1404.95620	1295620	257	1504.10681	1914690	234
1404.95621	1676218	247	1504.10681	1914690	269
1404.95621	1676218	257	1504.10681	1914690	269
1404.95622	1676219	247	1601.50013	1608352	211
1404.95622	1676219	257	1601.50013	1608352	227
1500.00000	-	229	1601.50015	1626102	211
1500.00000	-	234	1604.10580	1641743	227
1500.00000	-	249	1604.10580	1641743	247
1500.00001	-	229	1604.10580	1641743	258
1500.00001	-	234	1604.10580	1699301	227
1500.00001	-	249	1604.10580	1699301	247
1501.03000	1401731	213	1604.10580	1699301	258
1501.03000	1401731	229	1604.10580	1743685	227
1501.03001	1401713	213	1604.10580	1743685	247
1501.03001	1401713	229	1604.10580	1743685	258
1501.03100	1451482	213	1604.10581	1641742	227
1501.03100	1451482	229	1604.10581	1641742	247
1503.45100	-	250	1604.10581	1641742	258
1503.45100	-	250	1604.10581	1699300	227
1503.45100	-	260	1604.10581	1699300	247
1503.45100	-	260	1604.10581	1699300	258
1503.45100	-	270	1604.10581	1743684	227
1503.45100	-	270	1604.10581	1743684	247
1503.45101	-	250	1604.10581	1743684	258
1503.45101	-	250	1604.10582	1328861	247
1503.45101	-	260	1604.10583	1328860	247
1503.45101	-	260	1604.10584	1660961	258
1503.45101	-	270	1604.10584	1725271	258
1503.45101	-	270	1604.10585	1660960	258
1504.10500	1625986	250	1604.10585	1725270	258
1504.10501	1625985	250	1604.10586	1334109	247
1504.10600	1875576	234	1604.10586	1436684	247
1504.10600	1875576	269	1604.10586	1449529	247
1504.10601	1875577	234	1604.10587	1334108	247
1504.10601	1875577	269	1604.10587	1436683	247
1504.10602	1875578	234	1604.10587	1449528	247
1504.10602	1875578	269	1604.10588	1395361	227
1504.10603	1875580	234	1604.10588	1395361	247
1504.10603	1875580	269	1604.10588	1395361	258
1504.10604	1875579	234	1604.10588	1735355	227
1504.10604	1875579	269	1604.10588	1735355	247
1504.10606	1875581	235	1604.10588	1735355	258
1504.10606	1875581	269	1604.10588	1814096	227
1504.10607	-	250	1604.10588	1814096	247
1504.10607	-	260	1604.10588	1814096	258
1504.10607	-	270	1604.10589	1699932	227
1504.10608	-	250	1604.10589	1699932	247
1504.10608	-	260	1604.10589	1699932	258

ALL ITEMS MENTIONED IN OUR CATALOGUE ARE NOT ORIGINAL PARTS BUT PERFECTLY INTERCHANGEABLE WITH THEM.

GOVERNING LEGISLATIONS FOR THE SALE OF OUR PRODUCTS DIFFER IN EACH COUNTRY.

INFRINGEMENTS, IF ANY, OF LOCAL LEGISLATIONS ARE RESPONSIBILITY OF THE RETAILER IN THE COUNTRY OF FINAL DISTRIBUTION.



1604.10589	1743690	227	1604.72501	1725272	227
1604.10589	1743690	247	1701.53600	1400778	212
1604.10589	1743690	258	1701.53600	1406622	212
1604.10590	1636911	227	1701.53601	1400769	212
1604.10590	1636911	247	1701.53601	1407256	212
1604.10590	1636911	258	1704.10560	1305482	248
1604.10590	1699933	227	1704.10560	1305482	258
1604.10590	1699933	247	1704.10561	1305481	248
1604.10590	1699933	258	1704.10561	1305481	258
1604.10590	1743691	227	1704.10562	1305480	248
1604.10590	1743691	247	1704.10563	1305479	248
1604.10590	1743691	258	1704.10564	1296591	238
1604.10600	1835875	233	1704.10564	1296591	248
1604.10600	1835875	268	1704.10564	1296591	258
1604.10601	1835874	233	1704.10564	1296591	268
1604.10601	1835874	268	1704.10565	1296590	238
1604.10602	1835887	268	1704.10565	1296590	248
1604.10602	2032704	268	1704.10565	1296590	258
1604.10603	1835886	268	1704.10565	1296590	268
1604.10603	2032703	268	1704.10566	0159150	238
1604.10604	1846492	233	1704.10566	0159150	248
1604.10604	1846492	268	1704.10566	0159150	258
1604.10605	1846491	233	1704.10566	0159150	268
1604.10605	1846491	268	1704.10566	2013730	238
1604.10606	1857527	233	1704.10566	2013730	248
1604.10606	1857527	268	1704.10566	2013730	258
1604.10607	1857526	233	1704.10566	2013730	268
1604.10607	1857526	268	1704.10567	0159149	238
1604.55001	1626101	212	1704.10567	0159149	248
1604.56600	1892912	216	1704.10567	0159149	258
1604.56600	1892912	219	1704.10567	0159149	268
1604.56600	1892912	233	1704.10567	2013729	238
1604.56600	2032706	216	1704.10567	2013729	248
1604.56600	2032706	219	1704.10567	2013729	258
1604.56600	2032706	233	1704.10567	2013729	268
1604.56601	1892911	216	1704.10600	1872761	268
1604.56601	1892911	219	1704.10601	1872760	268
1604.56601	1892911	233	1704.55700	1406624	212
1604.56601	2032705	216	1704.55701	1406623	212
1604.56601	2032705	219	1704.63700	1328725	221
1604.56601	2032705	233	1704.63700	1328725	228
1604.56602	1892914	216	1704.63700	1617041	221
1604.56602	1892914	219	1704.63700	1617041	228
1604.56602	1892914	234	1704.63700	1651635	221
1604.56602	2032708	216	1704.63700	1651635	228
1604.56602	2032708	219	1704.63701	1328724	221
1604.56602	2032708	234	1704.63701	1328724	228
1604.56603	1892913	216	1704.63701	1617040	221
1604.56603	1892913	219	1704.63701	1617040	228
1604.56603	1892913	234	1704.63701	1651634	221
1604.56603	2032707	216	1704.63701	1651634	228
1604.56603	2032707	219	1704.63702	1879827	221
1604.56603	2032707	234	1704.63702	1879827	228
1604.56604	1706997	216	1904.55550	1400754	212
1604.56604	1706997	219	1904.55550	1400754	216
1604.56604	1714559	216	1904.55550	1400754	219
1604.56604	1714559	219	1904.55550	1406666	212
1604.56605	1706996	216	1904.55550	1406666	216
1604.56605	1706996	219	1904.55550	1406666	219
1604.56605	1714558	216	1904.55550	1705699	212
1604.56605	1714558	219	1904.55550	1705699	216
1604.72500	1660963	227	1904.55550	1705699	219
1604.72500	1725273	227	1904.55550	1707357	212
1604.72501	1660962	227	1904.55550	1707357	216



1904.55550	1707357	219
1904.55550	1714810	212
1904.55550	1714810	216
1904.55550	1714810	219
1904.55551	1400753	212
1904.55551	1400753	216
1904.55551	1400753	219
1904.55551	1406665	212
1904.55551	1406665	216
1904.55551	1406665	219
1904.55551	1705698	212
1904.55551	1705698	216
1904.55551	1705698	219
1904.55551	1707356	212
1904.55551	1707356	216
1904.55551	1707356	219
1904.55551	1714809	212
1904.55551	1714809	216
1904.55551	1714809	219
1904.72750	1374569	228
1904.72751	1374568	228
1904.72752	1918144	228
1904.72752	2130641	228
1904.72753	1918143	228
1904.72753	2130640	228
1904.72754	1779728	228
1904.72754	2148562	228
1904.72755	1779727	228
1904.72755	2148561	228
1904.95648	1918142	248
1904.95648	1918142	258
1904.95649	1918141	248
1904.95649	1918141	258
1904.95650	1354703	248
1904.95650	1354703	259
1904.95651	1354702	248
1904.95651	1354702	259
1904.95652	1918146	259
1904.95652	2130643	259
1904.95653	1918145	259
1904.95653	2130642	259
1904.95654	1779722	259
1904.95654	2148574	259
1904.95655	1779721	259
1904.95655	2148573	259
2104.85080	1371329	228
2104.85080	1660859	228
2104.85080	1871493	228
2104.95080	0393391	248
2104.95080	1295910	248
2104.95080	1607794	248
2404.10500	1651601	249
2404.10500	1651601	259
2404.55100	1400705	212
2404.63100	1372540	228
2404.95100	1238280	249
3004.00000	1234554	229
3004.00000	1649918	229
3004.00001	-	239
3004.00001	-	249
3004.00002	-	269

COS.ME

COS.PEL ref.	SIMILAR ref.	PAG
003007	A0005445411	305
003120	-	278
003120	-	280
003123	-	307
003123	-	317
003123	-	326
003123	-	335
005550	A0015406370	307
005560	A0015406270	307
005561	-	307
005562	-	307
005590	-	307
005600	-	307
005630	0015402670	289
005630	A0015401470	289
005640	0015402770	289
005640	A0015402870	289
005740	A0025445403	273
005750	A0025445503	273
005780	A0035445703	287
005790	A0035445303	287
009120	A0008261656	273
009121	A0008261556	273
009122	-	274
009210	A9068200264	278
009210	A9068200264	280
009211	A9068200164	278
009211	A9068200164	280
009610	A0035441803	335
009611	A0035441703	335
009612	-	336
011113	-	307
011171	A0025440790	289
011171	A0025440790	307
011181	A0025441290	289
011181	A0025441290	307
011191	-	307
011201	-	307
011241	A0025444790	273
011241	A0025444790	287
096300	A0025447390	335
096300	A0025447390	336
105.11219	9417500009	300
105.64100	A6417500618	288
105.64101	6417501009	288
105.64102	5007501602	288
105.64102	6417500002	288
105.64900	6497500118	290
105.91200	9018800385	272
105.91201	9018800103	272
105.91202	9017500202	272
105.92100	A9067500002	275
105.92101	A9068800385	275
105.92102	9068800003	275
105.92103	9066200024	275
105.93100	9068800257	279
105.93101	9068800403	279
105.93102	9068880051	279
105.94300	9437500009	308

ALL ITEMS MENTIONED IN OUR CATALOGUE ARE NOT ORIGINAL PARTS BUT PERFECTLY INTERCHANGEABLE WITH THEM.

GOVERNING LEGISLATIONS FOR THE SALE OF OUR PRODUCTS DIFFER IN EACH COUNTRY.

INFRINGEMENTS, IF ANY, OF LOCAL LEGISLATIONS ARE RESPONSIBILITY OF THE RETAILER IN THE COUNTRY OF FINAL DISTRIBUTION.



105.94302	9437500518	308	205.94084	9408812901-7354	292
105.94303	9437501518	318	205.94085	9448812801-7354	292
105.94304	9437501418	318	205.94100	9418811601	300
105.96149	9618851453	327	205.94101	9418811501	300
105.96151	9618850153-9135	327	205.94310	9438800406	308
105.96152	9608852684-9135	327	205.94311	9438800306	308
105.96153	9608852584-9135	327	205.94312	-	308
105.96154	9618850053-9135	327	205.94312	-	318
105.97310	A9738840185	282	205.96018	9605200067	328
201.32440	6625200019	290	205.96018	A9605200007	328
201.32440	9415220167	290	205.96019	9605200067	328
201.32440	9445220167	290	205.96019	A9605200107	328
201.32441	6625200019	290	205.96020	A9605200007	328
205.10100	6498810101	290	205.96021	A9605200107	328
205.10101	6498810001	290	205.96022	A9605200520	328
205.10201	6418810201	288	205.96023	9605200019	328
205.10300	6418810301	288	205.96024	9605200119	328
205.19998	9415240129	300	205.96025	9608813503	327
205.19999	9415240029	300	205.96025	9608817102	327
205.20000	9415201620	300	205.96026	9608813403	327
205.20001	9415200320	300	205.96027	9608816803-7G99	328
205.20002	A9415200219	300	205.96028	9608816903-7G99	328
205.20003	A9415200119	300	205.97305	A9738814701	282
205.20004	9415220004	301	305.64930	A6496600106	290
205.20005	9415220004	301	305.64931	A6496600006	290
205.20005	9415220167	301	305.67320	6736600301	281
205.20005	9445220167	301	305.67321	6736600201	281
205.20006	9305200007	308	305.94000	9446661401-7354	293
205.20006	9415220167	308	305.94001	9446661301-7354	293
205.20007	9305200007	292	305.94002	9406662501	293
205.20007	9305200007	309	305.94003	9406662401	293
205.20008	9305200207	292	305.94004	9406600201	293
205.20008	9305200207	309	305.94004	9406604801	293
205.20008	9305200207	318	305.94004	9406660201	293
205.20009	9305200207	309	305.94005	9406600101	293
205.20009	9305200207	318	305.94005	9406604701	293
205.20010	9305200119	293	305.94005	9406660101	293
205.20010	9305200119	309	305.94006	9406601201	293
205.20010	9305200119	319	305.94006	9406660601	293
205.20011	9305200019	293	305.94007	9406601101	293
205.20011	9305200019	309	305.94007	9406660501	293
205.20011	9305200019	319	305.94008	9446660201	293
205.20012	9305200107	309	305.94009	9446660101	293
205.20012	9305200107	319	305.94010	9406660005-7C72	293
205.20013	9305200020	309	305.94011	9446660301-7354	294
205.20013	9305200020	319	305.94012	9446660401-7354	294
205.20014	9305200120	293	305.94100	9416600101	301
205.20014	9305200120	309	305.94100	9416600301	301
205.20014	9305200120	319	305.94101	9416600001	301
205.20014	9305200820	293	305.94101	9416600201	301
205.20014	9305200820	309	305.94102	9416600501	301
205.20014	9305200820	319	305.94103	9416600401	301
205.20015	9305200107	309	305.94104	9416662001	301
205.20015	9305200107	319	305.94104	9416662001	310
205.91100	9016307007	272	305.94104	9416662001	319
205.91101	9016306907	272	305.94104	9436663901	301
205.92200	A9066377819	275	305.94104	9436663901	310
205.92201	A9066377719	275	305.94104	9436663901	319
205.93200	9068810201	279	305.94105	9416661901	301
205.93201	9068810101	279	305.94105	9416661901	310
205.94080	9408900625-7354	292	305.94105	9416661901	319
205.94081	9408900525-7354	292	305.94105	9436663801	301
205.94082	A9408900676-7354	292	305.94105	9436663801	310
205.94083	A9408900576-7354	292	305.94105	9436663801	319



305.94106	9416662201	301	405.93400	90688015709B51	279
305.94106	9416662201	319	405.93401	90688017709B51	280
305.94106	9436660501	301	405.94008	9448802404	294
305.94106	9436660501	319	405.94009	9448800104	294
305.94106	9436664301	301	405.94010	9448800370	294
305.94106	9436664301	319	405.94011	9448800270	294
305.94107	9416662101	301	405.94013	9408850125	295
305.94107	9416662101	319	405.94014	9408850225	295
305.94107	9436660401	301	405.94016	9448850125	295
305.94107	9436660401	319	405.94017	9448850725	295
305.94107	9436664201	301	405.94018	9448850625	295
305.94107	9436664201	319	405.94019	9448850525	295
305.94338	9436660737	310	405.94020	9448850774	294
305.94339	9436660637	310	405.94021	9448850574	294
305.94340	9436601101	310	405.94022	9448850674	294
305.94340	A9436600401-7354	310	405.94023	9408850122	294
305.94341	9436601001	310	405.94024	9408850422	294
305.94341	A9436600301-7354	310	405.94025	9408850322	294
305.94342	A9436660937-7354	310	405.94100	9418801070	301
305.94343	A9436660837-7354	310	405.94101	9418800970	301
305.94344	9436600701	310	405.94102	9418851401	294
305.94344	9436600701	319	405.94102	9418851401	301
305.94345	9436600601	310	405.94103	9418802370	302
305.94345	9436600601	319	405.94104	9418802470	302
305.94348	9436600901	310	405.94105	9418802770	302
305.94348	9436600901	320	405.94106	9418802870	302
305.94349	9436600801	310	405.94107	9418851301	302
305.94349	9436600801	320	405.94108	9418800225	302
305.94350	9436660901	320	405.94109	9418800325	303
305.94351	9436660801	320	405.94110	9418850922	295
305.94352	9436660005	310	405.94110	9418850922	302
305.94352	9436660005	320	405.94111	9418850825-7C72	302
305.94353	9436600228	310	405.94112	9418850925-7C72	302
305.94354	9436600128	311	405.94113	9418853822	302
305.96200	9616661801-9135	328	405.94114	9418853522	302
305.96201	9616661601-9135	328	405.94115	9418853422	302
305.96202	9606661903-7277	329	405.94358	9438800370	311
305.96202	9606662103-7277	329	405.94358	9438800370	320
305.96203	9606661703-7277	329	405.94358	9438809972	311
305.96204	9606662228	329	405.94358	9438809972	320
305.96205	9616661601-7277	329	405.94359	9438800270	311
305.96206	9616661801-7277	329	405.94359	9438800270	320
305.96207	9606661703-9135	329	405.94359	9438809872	311
305.96208	9606662103-9135	329	405.94359	9438809872	320
305.97340	A97366626017354	282	405.94360	9438800173	311
305.97341	A97366625017354	282	405.94360	9438800173	320
305.97342	9736663201	282	405.94360	A9438800770-7354	311
305.97343	9736663101	282	405.94360	A9438800770-7354	320
405.00070	6498800070	291	405.94361	9438800073	311
405.00136	6498800136	291	405.94361	9438800073	320
405.00236	6418800236	289	405.94361	A9438800670-7354	311
405.00270	6418800270	288	405.94361	A9438800670-7354	320
405.00471	6418809970	289	405.94362	A9438850201-7354	311
405.00471	6418809970	291	405.94362	A9438850201-7354	320
405.00472	6418800473	289	405.94363	A9438850226	311
405.00472	6418800473	291	405.94363	A9438850226	320
405.64988	6498800736	291	405.94363	A9438850426-7354	311
405.67300	6738800170	281	405.94363	A9438850426-7354	320
405.91670	9018800670	272	405.94365	9438850325	312
405.91670	9018800870	272	405.94366	9438850425	312
405.91671	9013100722	273	405.94367	9438850525	312
405.92190	A9068800170	276	405.94368	9438804373	311
405.92191	A9068800570-9B51	276	405.94368	9438804373	320
405.92192	A9066200234	276	405.94368	9438807470	311

ALL ITEMS MENTIONED IN OUR CATALOGUE ARE NOT ORIGINAL PARTS BUT PERFECTLY INTERCHANGEABLE WITH THEM.

GOVERNING LEGISLATIONS FOR THE SALE OF OUR PRODUCTS DIFFER IN EACH COUNTRY.

INFRINGEMENTS, IF ANY, OF LOCAL LEGISLATIONS ARE RESPONSIBILITY OF THE RETAILER IN THE COUNTRY OF FINAL DISTRIBUTION.



405.94368	9438807470	320	405.96105	A9608854725-9135	331
405.94368	9438809870	311	405.96106	A9608801990-9135	331
405.94368	9438809870	320	405.96107	9608850438-9135	331
405.94369	9438807570	311	405.96108	9608850538-9135	331
405.94369	9438807570	320	405.96109	9608850438-7G99	331
405.94370	9438850301	311	405.96110	9608850538-7G99	331
405.94370	9438850301	321	405.97380	A97388010707354	282
405.94371	9438840074	312	405.97381	A97388004707354	283
405.94372	9438840174	312	405.97382	A97388005707354	283
405.94373	9438850374	312	405.97390	A97388011707354	283
405.94374	9438850522	312	405.97391	A97388016707354	283
405.94375	9438850422	312	405.97392	A97388017707354	283
405.94376	9438800104	311	415.00090	A6288850401	337
405.94376	9438800104	321	415.00100	A6288802671	337
405.94376	9438804573	311	415.00104	A6288850505	337
405.94376	9438804573	321	415.00105	A6288800171	338
405.94376	9438807270	311	415.00107	A6288850102	338
405.94376	9438807270	321	415.00108	A6288850202	338
405.94377	9438800004	311	505.12033	0018112033	303
405.94377	9438800004	321	505.12100	-	312
405.94377	9438804473	311	505.12101	-	312
405.94377	9438804473	321	505.12102	-	312
405.94377	9438807370	311	505.12103	-	312
405.94377	9438807370	321	505.12104	9438104716	313
405.94378	9438850163	322	505.12106	0008109016	313
405.94379	9438850063	322	505.12107	0018109116	313
405.94380	9438840160	322	505.12108	0028110433	313
405.94381	9438840060	322	505.12109	0018109216	313
405.94382	9438851725	321	505.12110	0018116033	313
405.94383	9438851625	321	505.12231	0028106016	283
405.94384	9438851825	321	505.12231	0028106016	303
405.94385	9438851125	321	505.12232	0028100816	303
405.94386	9438851225	321	505.12233	0018112233	303
405.94387	9438851325	321	505.64110	6418104216	289
405.94388	9438851522	322	505.64110	6418104216	291
405.94389	9438851422	322	505.64111	6418104616	289
405.94390	A9438851322	322	505.64111	6418104616	291
405.94391	A9438851222	322	505.64112	6418104716	289
405.94392	9438851122	322	505.64112	6418104716	291
405.94393	9438804872-7354	321	505.92500	9068101993	276
405.94394	9438804972-7354	321	505.92500	9068104916	276
405.94395	9438806072-7354	321	505.92501	9068101893	276
405.94396	9438806172-7354	321	505.92501	9068104816	276
405.94397	9438850074	312	505.92502	9068106116	276
405.94398	9438850174	312	505.92503	9068106016	276
405.96086	9608857974	329	505.92504	9068102393	276
405.96087	9608857874	329	505.92504	9068105316	276
405.96088	9608853774	329	505.92505	9068102293	276
405.96089	9608853674	329	505.92505	9068105216	276
405.96090	A9608855025-9135	329	505.92506	9068106516	276
405.96091	A9608854925-9135	329	505.92507	9068106416	276
405.96092	A9608801790-9135	329	505.92508	9068102793	276
405.96093	A9608854725-7G99	330	505.92508	9068105716	276
405.96094	A9608854825-7G99	330	505.92509	9068102693	276
405.96095	A9608801990-7G99	330	505.92509	9068105616	276
405.96096	A9608853974	330	505.92510	9068106916	277
405.96097	A9608853874	330	505.92511	9068106816	277
405.96098	A9608850311	330	505.92512	0028111633	277
405.96099	A9608852108-9135	330	505.92513	0028111533	277
405.96100	A9608850181	330	505.92514	0028112033	277
405.96101	9608854925-7G99	330	505.92515	0028111933	277
405.96102	9608855025-7G99	330	505.94010	9408105516	283
405.96103	9608801790-7G99	330	505.94010	9408105516	295
405.96104	A9608854825-9135	331	505.94306	-	322



505.94307	-	322	505.97358	A0028114633	284
505.94308	-	322	505.97358	A0028114633	296
505.94309	-	322	505.97359	A0028114733	284
505.94310	9438106016	322	505.97359	A0028114733	296
505.94311	9438105816	322	705.94010	9738110810	296
505.94312	0028113433	323	705.94011	9738110510	297
505.94313	0028113333	323	705.94120	9418100010	303
505.94314	0028113833	323	705.94121	9418110010	303
505.94315	0028113733	323	705.94121	9418110610	303
505.94316	0028102716	323	705.94308	9438111010	314
505.94317	0028102616	323	705.94309	9438110010	314
505.94318	9438110407	323	705.94310	9438111210	314
505.94319	9438110307	323	705.94311	9438110210	314
505.94320	0028102516	323	705.94312	9438100610	324
505.94321	0028102416	323	705.94313	9438100410	324
505.94322	0028103314	323	705.96900	A9608110110	332
505.94323	0028103214	323	705.96900	A9608112310	332
505.94324	9408107316	283	705.96901	A9608111210	332
505.94324	9408107316	295	705.96901	A9608113010	332
505.94325	9438105116	313	705.96902	9608110010	332
505.94326	-	323	705.96902	9608112210	332
505.94327	9418102116	283	705.97300	9738110410	284
505.94327	9418102116	295	705.97301	9738110710	285
505.94327	9418102116	303	805.96801	A96052065559135	332
505.94327	9418102116	313	805.96801	A96052066559135	332
505.94327	9418102116	323	805.96801	A96052082559135	332
505.94327	A9418101016	283	805.96802	A96052040559135	332
505.94327	A9418101016	295	805.96802	A96052083559135	332
505.94327	A9418101016	303	905.64990	A6416201436	291
505.94327	A9418101016	313	905.64991	A6416201536	291
505.94327	A9418101016	323	905.84122	9418840322	304
505.96500	9608104716	331	905.84123	9418840222	304
505.96501	9608103516	331	905.84124	9418840522	304
505.96502	9608103416	331	905.84125	9418840422	304
505.96502	9608104316	331	905.84126	9418841522	304
505.96503	9608103316	331	905.84127	9418841422	304
505.96504	9608111107	331	905.84128	9418841222	304
505.96505	9608111007	331	905.84129	9418841122	304
505.96506	9608110707	331	905.94090	9448840122	297
505.96507	9608110607	331	905.94090	9448840722	297
505.96508	9608111507	332	905.94091	9448840022	297
505.96509	9608111407	332	905.94092	9448840322	297
505.96510	A0028116433	332	905.94093	9448840222	297
505.96511	A0028116333	332	905.94094	9448840522	297
505.96512	A0028116633	332	905.94095	9448840422	297
505.96513	A0028116533	332	905.94160	9418800444	304
505.96519	A0028106016	324	905.94161	9418800344	304
505.96519	A0028106016	332	905.94162	-	304
505.97350	0008102179	283	905.94163	-	304
505.97350	0008102179	295	905.94164	9418840722	304
505.97351	0008102079	283	905.94165	9418840622	304
505.97351	0008102079	295	905.94370	9438840123	314
505.97352	A0008101579	284	905.94371	9438840023	314
505.97352	A0008101579	296	905.94372	9438840323	314
505.97353	A0008101879	284	905.94373	9438840223	314
505.97353	A0008101879	296	905.94374	9438840723	314
505.97354	0008102479	284	905.94375	9438840623	314
505.97354	0008102479	296	905.94376	9438841822	324
505.97355	A0008101679	284	905.94377	9438841722	324
505.97355	A0008101679	296	905.94378	9438842022	324
505.97356	A0018119933	284	905.94379	9438841922	324
505.97356	A0018119933	296	905.96171	9607511230	333
505.97357	A0028110033	284	905.96172	9607511330	333
505.97357	A0028110033	296	905.96173	9607510630	333

ALL ITEMS MENTIONED IN OUR CATALOGUE ARE NOT ORIGINAL PARTS BUT PERFECTLY INTERCHANGEABLE WITH THEM.

GOVERNING LEGISLATIONS FOR THE SALE OF OUR PRODUCTS DIFFER IN EACH COUNTRY.

INFRINGEMENTS, IF ANY, OF LOCAL LEGISLATIONS ARE RESPONSIBILITY OF THE RETAILER IN THE COUNTRY OF FINAL DISTRIBUTION.



905.96174	9607510730	333	1405.96100	9607201001-7277	334
905.96175	9608803905-9135	333	1405.96101	9607200901-7277	334
905.96176	9608804005-9135	333	1405.96102	9607201201-7277	334
905.96177	9608859408-9135	333	1405.96103	9607201101-7277	334
905.96178	9608859508-9135	333	1500.00000	-	307
905.96179	9607511030	333	1500.00000	-	317
905.96180	9607511130	333	1500.00000	-	326
905.96181	9607510430	333	1500.00000	-	336
905.96182	9607510530	333	1500.00001	-	307
905.97311	9738840123	285	1500.00001	-	317
905.97312	9738840223	285	1500.00001	-	326
1001.23641	9415220067	306	1500.00001	-	336
1001.23641	9445220167	306	1503.45102	A008262156	278
1005.00002	9415410103	304	1503.45102	A008262156	280
1005.00003	9415220167	306	1503.45103	A008262056	278
1005.94000	9406660428	297	1503.45103	A008262056	280
1005.94000	9406660428	324	1505.92000	A9068201764	278
1005.94001	9406660128	297	1505.92000	A9068201764	280
1005.94001	9406660128	324	1505.92001	A9068200464	278
1005.94002	9406601930	297	1505.92001	A9068200464	280
1005.94003	9406601830	297	1605.91600	A9018201161	273
1005.94300	9416663428	305	1605.91601	A9018201061	273
1005.94300	9416663428	324	1605.92600	A2118200656	277
1005.94301	9436660028	314	1605.92601	A2118200556	277
1005.94302	9416663828	305	1605.92602	-	277
1005.94302	9416663828	325	1605.92603	-	277
1005.94303	9416663728	305	1605.92604	A9068200261	277
1005.94303	9416663728	325	1605.92605	A9068200161	277
1005.94304	9416663528	305	1605.92606	-	277
1005.94304	9416663528	325	1605.92607	-	277
1005.94305	9416663328	305	1605.92608	A9068200661	278
1005.94305	9416663328	325	1605.92609	A9068200561	278
1005.94306	9438810011	315	1605.926100018229020 + 0008201277		277
1005.94307	9436660931	315	1605.926110018229320 + 0008201277		277
1005.94308	9436661031	315	1605.93600	9068202461	280
1005.94312	9436660578	315	1605.93601	9068202361	280
1005.94313	9436660478	315	1605.93602	9068204161	280
1005.94314	9436660778	315	1605.93603	9068204061	280
1005.94315	9436660678	315	1605.93604	A9068200356	280
1005.94316	9436660278	315	1605.93605	A9068200256	280
1005.94317	9436660178	315	1605.94058	A9408200461	298
1005.94318	9438853514	315	1605.94059	A9408200361	298
1005.94319	9438853414	315	1605.94060	9408200261	298
1005.96001	9605200067	335	1605.94061	9408200161	298
1005.96002	A9605211540	335	1605.94062	9408200421	297
1005.96003	-	335	1605.94063	9408200321	297
1005.97000	9705253539	285	1605.94064	0008200777	298
1005.97001	9705253439	285	1605.94064	9408200221	298
1005.97302	3755410103	285	1605.94065	9408200056	298
1005.97303	9736661328	285	1605.94066	9408200156	298
1005.97304	9736661428	285	1605.94067	-	298
1005.97305	9736661528	285	1605.94160	9418202661	306
1005.97306	9736661628	285	1605.94160	9418205261	306
1105.96500	9608802703	333	1605.94161	9418202561	306
1105.96501	9608802603	333	1605.94161	9418205161	306
1105.96502	9608803403	333	1605.94162	A9418200921	305
1105.96503	9608803303	333	1605.94163	A9418200521	305
1405.64150	6417201271	289	1605.94164	0301081114	306
1405.64151	6417201171	289	1605.94164	9418205461	306
1405.94101	A9417200570	305	1605.94165	0301081119	306
1405.94102	9417280956	325	1605.94165	9418205361	306
1405.94103	9417280856	325	1605.94166	9418201321	305
1405.94104	9417200448	325	1605.94167	A0028208456	306
1405.94105	9417200348	325	1605.94168	A0028208556	306



1605.94169	A0028208656	306
1605.94170	A0028208756	306
1605.94354	9438202361	315
1605.94355	9438202261	315
1605.94358	9438200461	316
1605.94359	9438200361	316
1605.94360	9438200261	316
1605.94361	9438200161	316
1605.94362	9438200156	316
1605.94363	9438200056	316
1605.94364	A9438201561	325
1605.94365	A9438201461	325
1605.94366	A9438201761	325
1605.94367	A9438201661	325
1605.94368	0008264610	326
1605.94369	0008264710	326
1605.94370	9438260359	316
1605.94371	9438260259	316
1605.94372	A9438200856	315
1605.94372	A9438200856	325
1605.94373	A9438200756	315
1605.94373	A9438200756	325
1605.96100	9608200339	334
1605.96101	9608200239	334
1605.96102	9608200739	334
1605.96103	9608200639	334
1605.96104	9608200539	334
1605.96105	9608200439	334
1605.96106	A9608201056	334
1605.96107	A9608200956	334
1605.96108	A9608200556	334
1605.96109	A9608200456	334
1605.96110	9608201121	334
1605.96111	9608201021	334
1605.96112	A9608200939	335
1605.96113	A9608200839	335
1605.97300	9738200421	285
1605.97301	9738200321	285
1605.97302	9738200621	286
1605.97303	9738200521	286
1605.97304	9738200661	286
1605.97305	9738200561	286
1605.97306	9738200261	286
1605.97307	9738200161	286
1605.97308	9738202961	286
1605.97309	9738202861	286
1605.97310	A9738200221	286
1605.97311	A9738200121	286
1605.97312	9678200221	286
1605.97313	9678200121	286
1605.97314	A9738202761	286
1605.97315	A9738202661	286
1605.97316	A9738202561	287
1605.97317	A9738202461	287
1605.97318	9678201221	286
1605.97319	9678201121	286
1705.94100	A9417600559	306
1705.94101	A9417600459	306
1705.94350	9417230120	316
1705.94351	9417200037	316
1705.94352	9417200837	316
1705.96100	9607230709	335
1705.96101	9607230609	335
1705.97310	0007601359	273

1705.97310	0007601359	287
1805.91094	9016710020	273
1805.91094	9016710220	273
1905.64100	6417200346	289
1905.91500	9017201246	273
1905.91501	9017201146	273
1905.94000	0007200179	326
1905.94001	0007200079	326
1905.97350	9737200446	287
1905.97350	9737200446	298
1905.97351	9737200346	287
1905.97351	9737200346	298
2000.00013	-	273
2000.00014	-	307
2105.94080	A9405010003	298
2105.94180	9100002004	316
2105.94180	A0005003149	316
2105.94181	A0005003049	316
2105.94181	A0005003449	316
2105.94181	A0005003849	316
2405.94100	A0019808464	298
2405.94100	A0019808464	306
2405.94100	A0019808464	317
2405.94100	A0019808464	326
3005.00000	-	335
3005.00001	-	317
3005.00001	-	326
3005.00002	-	287
3005.00002	-	299
3005.00003	-	307

COS.IVE

COS.PEL ref.	SIMILAR ref.	PAG
002986	5801631615	408
002986	5801631615	414
002986	5801631615	499
002986	5801631615	507
002986	5801631615	517
002987	-	450
002987	-	454
002987	-	460
002987	-	470
002987	-	482
002987	-	493
002987	-	499
002987	-	507
002987	-	517
002988	41200664	450
002988	41200664	454
002988	41200664	460
002988	41200664	470
002988	41200664	482
002988	41200664	493
002988	41200664	499
002988	41200664	507
002988	41200664	518
003001	500308514	460
003001	500308514	471
003119	-	485
003119	-	496
003119	-	509
003119	-	520

ALL ITEMS MENTIONED IN OUR CATALOGUE ARE NOT ORIGINAL PARTS BUT PERFECTLY INTERCHANGEABLE WITH THEM.

GOVERNING LEGISLATIONS FOR THE SALE OF OUR PRODUCTS DIFFER IN EACH COUNTRY.

INFRINGEMENTS, IF ANY, OF LOCAL LEGISLATIONS ARE RESPONSIBILITY OF THE RETAILER IN THE COUNTRY OF FINAL DISTRIBUTION.



003122	-	463	008600	500356783	353
003122	-	474	011110	93161844	435
003123	-	357	011110	93161844	435
003123	-	359	011110	93161844	447
003123	-	365	011110	93161844	447
003123	-	399	011110	93161844	509
003123	-	405	011110	93161844	509
003123	-	410	011110	93161844	520
003123	-	415	011110	93161844	520
003123	-	463	011111	-	435
003123	-	474	011111	-	435
003123	-	485	011111	-	446
003123	-	496	011111	-	447
003950	5801351224	357	011112	-	435
003950	581631433	357	011112	-	447
003950	69500026	357	012621	42471138	347
003951	5801351218	357	012621	42471138	353
003951	581631438	357	012621	42471138	373
003951	69500032	357	012621	42471138	377
003970	1904639	347	012621	42471138	380
003970	1907700	347	012621	42471138	385
003980	1904640	347	012621	7984015	347
003980	1907701	347	012621	7984015	353
006140	-	435	012621	7984015	373
006140	-	446	012621	7984015	377
006141	99463243	435	012621	7984015	380
006141	99463243	447	012621	7984015	385
006142	99463242	435	012721	42471137	347
006142	99463242	447	012721	42471137	353
006143	99463244	435	012721	42471137	373
006143	99463244	447	012721	42471137	377
006150	-	435	012721	42471137	380
006150	-	446	012721	42471137	385
006151	-	435	012721	7984016	347
006151	-	447	012721	7984016	353
006152	-	435	012721	7984016	373
006152	-	447	012721	7984016	377
006153	5801363428	509	012721	7984016	380
006153	5801363428	520	012721	7984016	385
006154	5801363431	509	013901	42555131	357
006154	5801363431	520	013901	42555132	357
006155	5801363432	509	106.02002	504110983	367
006155	5801363432	520	106.02002	504110983	374
006157	-	509	106.02002	504110983	378
006157	-	520	106.02002	8142413	367
006880	-	435	106.02002	8142413	374
006880	-	447	106.02002	8142413	378
008550	500382617	373	106.08100	500431530	523
008550	500382617	377	106.09100	5949782801	524
008550	500382617	380	106.11501	4814210	417
008550	500382617	385	106.11503	4786009	417
008550	98421202	373	106.18150	5801690072	406
008550	98421202	377	106.18150	5801690072	411
008550	98421202	380	106.18151	5801690084	406
008550	98421202	385	106.18151	5801690084	411
008560	500382616	373	106.18152	5801711046	406
008560	500382616	377	106.18152	5801711046	411
008560	500382616	380	106.18153	5801711048	406
008560	500382616	385	106.18153	5801711048	411
008560	98421203	373	106.18154	5801733767	406
008560	98421203	377	106.18154	5801733767	411
008560	98421203	380	106.19048	42332745	419
008560	98421203	385	106.22470	4722470	422
008590	500356782	353	106.23100	93924351	340



106.23101	93924352	340	206.11522	4787187	417
106.23102	93914768	340	206.11523	4787184	417
106.23103	93914769	340	206.13000	504054940	386
106.23150	93923150	340	206.13000	504059309	386
106.23151	93924652	340	206.13001	504054941	386
106.23152	93924614	340	206.13001	504059310	386
106.23737	93923737	341	206.13002	504054942	386
106.33130	93923758	341	206.13003	504054943	386
106.33130	93933130	341	206.13040	504055140	386
106.37476	93937476	341	206.13040	504055140	391
106.37668	93937668	341	206.13041	504055141	386
106.37668	93937670	341	206.13041	504055141	391
106.37669	93937669	341	206.15010	500317978	378
106.39140	3800056	354	206.15011	500317979	378
106.39141	3800059	354	206.17944	500317944	367
106.39144	3802803	354	206.17944	500317946	367
106.39144	3802804	354	206.17945	500317945	367
106.39145	5801255767	354	206.17945	500317947	367
106.40100	5801492603	360	206.17956	500317956	374
106.40101	5801772693	360	206.17957	500318079	374
106.40101	5802341775	360	206.17958	8142605	374
106.40102	5801587018	360	206.17959	8142609	374
106.40103	5801513863	360	206.18011	504054990	391
106.41100	5801342732	358	206.18012	504054991	391
106.43890	8143416	423	206.18013	504054992	391
106.46218	500328278	348	206.18014	504301907	400
106.46218	504046218	348	206.18014	504301907	411
106.68201	4588444	526	206.18014	5801622723	400
106.68202	4597675	526	206.18014	5801622723	411
106.70100	504258217	395	206.18015	504301912	400
106.70100	504258217	400	206.18015	504301912	411
106.70436	504056436	452	206.18336	8142630	374
106.70436	504056436	456	206.18337	8142629	374
106.71666	99471666	348	206.18338	500318338	374
106.75461	504027461	381	206.18339	500318289	374
106.75461	504027461	386	206.18339	500318293	374
106.75461	504027461	391	206.18340	500318341	367
106.80106	500398112	465	206.18341	500318345	367
106.89947	99489947	348	206.18342	8142621	367
106.90100	504170809	486	206.18343	8142626	367
106.90100	504170848	486	206.19031	42341982	419
106.90200	504170979	475	206.23131	93923131	341
106.92100	5801549064	511	206.23132	93923132	341
106.92101	5801549092	501	206.23133	99489794	348
106.92101	5801549092	511	206.23133	99489805	348
106.93150	5801550647	497	206.23134	99489371	348
106.93150	5801550647	501	206.23134	99489793	348
206.00001	8144468	423	206.23136	93936994	341
206.00001	8144468	436	206.23137	93936995	341
206.00001	8144468	448	206.23138	93933538	341
206.00002	8144469	423	206.23139	500326797	348
206.00002	8144469	436	206.23140	500326798	348
206.00002	8144469	448	206.23141	500326802	349
206.01999	8142604	367	206.23142	500326801	349
206.02000	8142603	367	206.24321	42324321	422
206.02927	41002927 sx	424	206.24322	42324322	422
206.02927	41002927 sx	436	206.24323	42324330	422
206.02927	41002927 sx	448	206.28251	2997165	424
206.02927	41003236 dx	424	206.28251	2997165	436
206.02927	41003236 dx	436	206.28251	41032399	424
206.02927	41003236 dx	448	206.28251	41032399	436
206.07200	172145	522	206.28251	42533556	424
206.07201	172146	522	206.28251	42533556	436
206.08200	60164734	527	206.28251	42559051	424

ALL ITEMS MENTIONED IN OUR CATALOGUE ARE NOT ORIGINAL PARTS BUT PERFECTLY INTERCHANGEABLE WITH THEM.

GOVERNING LEGISLATIONS FOR THE SALE OF OUR PRODUCTS DIFFER IN EACH COUNTRY.

INFRINGEMENTS, IF ANY, OF LOCAL LEGISLATIONS ARE RESPONSIBILITY OF THE RETAILER IN THE COUNTRY OF FINAL DISTRIBUTION.



206.28251	42559051	436	206.28934	41032407	438
206.28252	2997166	424	206.28934	41210252	425
206.28252	2997166	436	206.28934	41210252	438
206.28252	41032400	424	206.28934	41210253	425
206.28252	41032400	436	206.28934	41210253	438
206.28252	42533556	424	206.28934	41210254	425
206.28252	42533556	436	206.28934	41210254	438
206.28252	42559051	424	206.28934	41210255	425
206.28252	42559051	436	206.28934	41210255	438
206.28253	2997166	424	206.32881	42332881	419
206.28253	2997166	437	206.39100	3800001	354
206.28253	41032400	424	206.39100	3800001	358
206.28253	41032400	437	206.39100	5801352978	354
206.28254	2997165	424	206.39100	5801352978	358
206.28254	2997165	437	206.39101	3800002	354
206.28254	41032399	424	206.39101	3800002	358
206.28254	41032399	437	206.39101	5801352974	354
206.28255	2997168	424	206.39101	5801352974	358
206.28255	2997168	437	206.39102	3802038	355
206.28255	41032402	424	206.39103	3802037	355
206.28255	41032402	437	206.40150	5801513999	360
206.28256	2997169	424	206.40151	5801513992	360
206.28256	2997169	437	206.40152	5801863943	361
206.28256	42533609	424	206.40153	5801863940	361
206.28256	42533609	437	206.40154	5801847156	361
206.28257	2997167	424	206.40155	5801847150	361
206.28257	2997167	437	206.40156	5801847137	361
206.28257	41032401	424	206.40157	5801847132	361
206.28257	41032401	437	206.40158	5801530202	361
206.28258	2997168	425	206.42028	98442028	436
206.28258	2997168	437	206.42029	98442029	436
206.28258	41032402	425	206.42483	8142843	375
206.28258	41032402	437	206.42842	8142842	368
206.28258	42533556	425	206.42843	98456508	368
206.28258	42533556	437	206.44000	8144329	423
206.28258	42559051	425	206.44000	8144329	448
206.28258	42559051	437	206.44001	8144328	423
206.28259	2997167	425	206.44001	8144328	448
206.28259	2997167	437	206.44002	8144315	423
206.28259	41032401	425	206.44002	8144315	448
206.28259	41032401	437	206.44003	8144314	423
206.28259	42533556	425	206.44003	8144314	448
206.28259	42533556	437	206.44004	8144318	423
206.28259	42559051	425	206.44005	8144317	423
206.28259	42559051	437	206.54008	504003993	452
206.28933	2997163	425	206.54008	504003993	456
206.28933	2997163	437	206.54008	504003993	465
206.28933	41032409	425	206.54008	504208707	452
206.28933	41032409	437	206.54008	504208707	456
206.28933	41032410	425	206.54008	504208707	465
206.28933	41032410	437	206.54009	504003992	452
206.28933	41032412	425	206.54009	504003992	456
206.28933	41032412	437	206.54009	504003992	465
206.28933	41032413	425	206.54009	504208706	452
206.28933	41032413	437	206.54009	504208706	456
206.28934	2997164	425	206.54009	504208706	465
206.28934	2997164	438	206.68639	9068642	416
206.28934	41032403	425	206.68640	9068641	416
206.28934	41032403	438	206.70120	504299444	395
206.28934	41032405	425	206.70120	504299444	406
206.28934	41032405	438	206.70121	504299045	395
206.28934	41032406	425	206.70121	504299045	406
206.28934	41032406	438	206.70530	504103239	452
206.28934	41032407	425	206.70530	504103239	456



206.70530	504211275	452	206.80749	41213751	466
206.70530	504211275	456	206.80749	41213751	476
206.70531	504103238	452	206.80749	41213751	487
206.70531	504103238	456	206.80750	41213750	457
206.70531	504211274	452	206.80750	41213750	466
206.70531	504211274	456	206.80750	41213750	476
206.70532	504047586	475	206.80750	41213750	487
206.70532	504103300	475	206.80751	41213754	457
206.70533	504047585	475	206.80751	41213754	466
206.70533	504102299	475	206.80751	41213754	476
206.75120	504037735	381	206.80751	41213754	487
206.75120	504058445	381	206.80752	41213753	457
206.75121	504037737	381	206.80752	41213753	466
206.75121	504058446	381	206.80752	41213753	476
206.75123	504052237	381	206.80752	41213753	487
206.75123	504058448	381	206.80753	-	457
206.75124	504052236	381	206.80753	-	466
206.75124	504058447	381	206.80753	-	476
206.75300	504027536	381	206.80753	-	488
206.75300	504080951	381	206.80754	41299384	457
206.75301	504027537	381	206.80754	41299384	466
206.75301	504080952	381	206.80754	41299384	475
206.80540	504103307	465	206.80754	41299384	486
206.80540	5801840462	465	206.89964	4689964	526
206.80541	504104892	465	206.90096	504132808	486
206.80541	504108987	465	206.90096	504132808	511
206.80541	5801840490	465	206.90096	504132811	486
206.80700	41218984	456	206.90096	504132811	511
206.80700	41218984	465	206.90096	5801840558	486
206.80700	41218984	475	206.90096	5801840558	511
206.80700	41218984	486	206.90096	5801840561	486
206.80701	41218983	456	206.90096	5801840561	511
206.80701	41218983	465	206.90097	504211219	486
206.80701	41218983	475	206.90097	504211219	511
206.80701	41218983	486	206.90097	5801840565	486
206.80702	41213720	456	206.90097	5801840565	511
206.80702	41213720	465	206.90098	504020073	487
206.80702	41213720	475	206.90098	504020073	511
206.80702	41213720	486	206.90098	504103308	487
206.80703	41213721	456	206.90098	504103308	511
206.80703	41213721	465	206.90098	5801840545	487
206.80703	41213721	475	206.90098	5801840545	511
206.80703	41213721	486	206.90099	500375472	487
206.80747	2997670	457	206.90099	500375472	511
206.80747	2997670	466	206.90099	504103305	487
206.80747	2997670	476	206.90099	504103305	511
206.80747	2997670	487	206.90099	5801840550	487
206.80747	41213696	457	206.90099	5801840550	511
206.80747	41213696	466	206.90100	504090861	476
206.80747	41213696	476	206.90100	504090861	487
206.80747	41213696	487	206.90101	504090862	476
206.80747	41213751	457	206.90101	504090862	487
206.80747	41213751	466	206.90196	2997670	501
206.80747	41213751	476	206.90196	2997670	512
206.80747	41213751	487	206.90196	41298976	501
206.80748	2997670	457	206.90196	41298976	512
206.80748	2997670	466	206.90197	504138502	511
206.80748	2997670	476	206.90198	504138503	511
206.80748	2997670	487	206.90199	41298976	501
206.80748	41213750	457	206.90199	41298976	512
206.80748	41213750	466	206.90200	41298975	502
206.80748	41213750	476	206.90200	41298975	512
206.80748	41213750	487	206.90201	41298962	502
206.80749	41213751	457	206.90201	41298962	512

ALL ITEMS MENTIONED IN OUR CATALOGUE ARE NOT ORIGINAL PARTS BUT PERFECTLY INTERCHANGEABLE WITH THEM.

GOVERNING LEGISLATIONS FOR THE SALE OF OUR PRODUCTS DIFFER IN EACH COUNTRY.

INFRINGEMENTS, IF ANY, OF LOCAL LEGISLATIONS ARE RESPONSIBILITY OF THE RETAILER IN THE COUNTRY OF FINAL DISTRIBUTION.



206.90202	41298964	502	306.05624	2997316	426
206.90202	41298964	512	306.05624	98417357	426
206.90203	41298973	502	306.05625	98429703	425
206.90203	41298973	512	306.05626	98429699	425
206.90204	41298974	502	306.05627	-	425
206.90204	41298974	512	306.05628	-	425
206.90205	41298887	502	306.07300	193997	522
206.90205	41298887	512	306.07301	193996	522
206.90206	41298888	502	306.08300	136213	523
206.90206	41298888	512	306.08300	500420559	523
206.90207	-	502	306.08301	136212	523
206.90207	-	512	306.08301	500420558	523
206.90208	2997670	502	306.09300	5949800616	524
206.90208	2997670	513	306.09301	5949800615	524
206.90208	41213696	502	306.09302	5949800619	524
206.90208	41213696	513	306.09303	5949800617	524
206.90208	41298975	502	306.09304	5949800621	524
206.90208	41298975	513	306.09305	5949800620	524
206.92100	41289079	502	306.09306	5949801378	524
206.92100	41289079	513	306.09307	5949801377	524
206.92101	41288784	503	306.11530	4786002	417
206.92101	41288784	513	306.11531	4786003	417
206.92101	41289081	503	306.15030	500318230	378
206.92101	41289081	513	306.15030	8142616	378
206.92101	5801698293	503	306.15031	500318229	378
206.92101	5801698293	513	306.15031	8142617	378
206.92102	41288786	503	306.18020	504055010	391
206.92102	41288786	513	306.18020	504060076	391
206.92102	41289082	503	306.18021	504055011	391
206.92102	41289082	513	306.18021	504060077	391
206.92102	5801698294	503	306.19049	42332920	419
206.92102	5801698294	513	306.33100	500312441	349
206.92103	41288783	503	306.33101	500312439	349
206.92103	41288783	513	306.35020	93932871	342
206.92103	41289087	503	306.42252	42342252	419
206.92103	41289087	513	306.42644	500318241	375
206.92104	41288785	503	306.42645	500318238	375
206.92104	41288785	513	306.44030	4703771	422
206.92104	41289088	503	306.44031	4703772	422
206.92104	41289088	513	306.66161	2997121	449
206.92105	41288776	503	306.66161	98466162	449
206.92105	41288776	513	306.66162	2997120	449
206.92106	41288777	503	306.66162	98466161	449
206.92106	41288777	513	306.66163	98466330	448
206.92107	2997670	503	306.66164	98466328	448
206.92107	2997670	513	306.66170	3798915	449
206.92107	41213696	503	306.70228	9070228	416
206.92107	41213696	513	306.70229	9070229	416
206.92107	41289079	503	306.78190	2997737	452
206.92107	41289079	513	306.78190	2997737	497
206.93200	-	497	306.78190	504161152	452
206.93201	-	497	306.78190	504161152	497
206.93202	504211275	497	306.78191	2997736	452
206.93203	504211274	497	306.78191	2997736	497
206.93204	-	501	306.78191	504161151	452
206.93205	-	501	306.78191	504161151	497
306.05560	98405560	438	306.78192	2997735	452
306.05561	98405561	438	306.78192	2997735	497
306.05621	2997319	438	306.78192	504161150	452
306.05621	98438467	438	306.78192	504161150	497
306.05622	2997318	438	306.78193	2997734	452
306.05622	98438466	438	306.78193	2997734	497
306.05623	2997317	426	306.78193	504161149	452
306.05623	98417358	426	306.78193	504161149	497



306.78194	2997733	453	306.80012	2997739	477
306.78194	2997733	498	306.80012	2997739	488
306.78194	504103237	453	306.80012	2997739	503
306.78194	504103237	498	306.80012	2997739	513
306.78195	2997732	453	306.80012	504136556	477
306.78195	2997732	498	306.80012	504136556	488
306.78195	504103236	453	306.80012	504136556	503
306.78195	504103236	498	306.80012	504136556	513
306.78196	2997731	453	306.80012	504368383	477
306.78196	2997731	498	306.80012	504368383	488
306.78196	504103235	453	306.80012	504368383	503
306.78196	504103235	498	306.80012	504368383	513
306.78197	2997730	453	306.80013	2997738	477
306.78197	2997730	498	306.80013	2997738	488
306.78197	504103234	453	306.80013	2997738	503
306.78197	504103234	498	306.80013	2997738	513
306.78198	2997524	453	306.80013	504136555	477
306.78198	2997524	498	306.80013	504136555	488
306.78198	504103233	453	306.80013	504136555	503
306.78198	504103233	498	306.80013	504136555	513
306.78198	504218912	453	306.80013	504368379	477
306.78198	504218912	498	306.80013	504368379	488
306.78199	2997523	453	306.80013	504368379	503
306.78199	2997523	498	306.80013	504368379	513
306.78199	504103232	453	306.80014	2997579	458
306.78199	504103232	498	306.80014	2997579	477
306.78199	504218911	453	306.80014	504215973 grigio	458
306.78199	504218911	498	306.80014	504215973 grigio	477
306.78200	504102899	453	306.80014	504368370 nero	458
306.78201	504097984	453	306.80014	504368370 nero	477
306.78202	504097984	453	306.80015	2997578	458
306.78202	504097984	498	306.80015	2997578	477
306.78202	504097996	453	306.80015	504215971 grigio	458
306.78202	504097996	498	306.80015	504215971 grigio	477
306.78202	504102899	453	306.80015	504368371 nero	458
306.78202	504102899	498	306.80015	504368371 nero	477
306.78202	504102900	453	306.80016	2997119	458
306.78202	504102900	498	306.80016	2997119	467
306.78203	5040053092	498	306.80016	500375431	458
306.78204	504053093	498	306.80016	500375431	467
306.79578	3798110	425	306.80017	2997118	458
306.79578	3798110	449	306.80017	2997118	467
306.79579	3798109	425	306.80017	500375430	458
306.79579	3798109	449	306.80017	500375430	467
306.79580	3797997	425	306.80018	504001361	458
306.79580	3797997	438	306.80018	504001361	467
306.79581	3797996	425	306.80018	504001361	477
306.79581	3797996	438	306.80018	504217554 nero	458
306.79582	3796975	426	306.80018	504217554 nero	467
306.79582	3796975	438	306.80018	504217554 nero	477
306.79583	3796974	426	306.80019	504001358	458
306.79583	3796974	438	306.80019	504001358	467
306.79584	3798826	438	306.80019	504001358	477
306.79585	3798602	438	306.80019	504217553 nero	458
306.79586	3797065	426	306.80019	504217553 nero	467
306.79586	3797065	449	306.80019	504217553 nero	477
306.79587	3797064	426	306.80020	504001345	458
306.79587	3797064	449	306.80020	504001345	467
306.79588	3798409	438	306.80020	504001345	477
306.79589	3798408	438	306.80020	504217526 nero	458
306.80010	2997741	477	306.80020	504217526 nero	467
306.80010	504136562	477	306.80020	504217526 nero	477
306.80011	2997740	477	306.80021	504001344	458
306.80011	504136561	477	306.80021	504001344	467

ALL ITEMS MENTIONED IN OUR CATALOGUE ARE NOT ORIGINAL PARTS BUT PERFECTLY INTERCHANGEABLE WITH THEM.

GOVERNING LEGISLATIONS FOR THE SALE OF OUR PRODUCTS DIFFER IN EACH COUNTRY.

INFRINGEMENTS, IF ANY, OF LOCAL LEGISLATIONS ARE RESPONSIBILITY OF THE RETAILER IN THE COUNTRY OF FINAL DISTRIBUTION.



306.80021	504001344	477	406.05628	500389854	439
306.80021	504217525 nero	458	406.11514	9068599	416
306.80021	504217525 nero	467	406.11533	4786006	417
306.80021	504217525 nero	477	406.13090	500042692	386
306.80022	504368373	503	406.13090	500042692	392
306.80022	504368373	513	406.13090	504027618	386
306.80023	504368376	503	406.13090	504027618	392
306.80023	504368376	513	406.13090	504049813	386
306.80024	2997119	458	406.13090	504049813	392
306.80024	2997119	467	406.13091	500042691	387
306.80024	500375431	458	406.13091	500042691	392
306.80024	500375431	467	406.13091	504027620	387
306.80025	2997118	458	406.13091	504027620	392
306.80025	2997118	467	406.13091	504049814	387
306.80025	500375430	458	406.13091	504049814	392
306.80025	500375430	467	406.15089	500317145	378
306.80026	2997119	477	406.15089	8143221	378
306.80026	2997119	488	406.15090	500317145	378
306.80026	2997119	503	406.15091	500317145	379
306.80026	2997119	514	406.15091	8143221	379
306.80026	500375431	477	406.16090	504281893	400
306.80026	500375431	488	406.16090	5801802740	400
306.80026	500375431	503	406.16091	504281894	400
306.80026	500375431	514	406.16091	504281895	400
306.80027	2997119	477	406.16091	5801802741	400
306.80027	2997119	488	406.16091	5801804153	400
306.80027	2997119	503	406.16092	504281899	400
306.80027	2997119	514	406.16092	5801802895	400
306.80027	500375431	477	406.16093	504281900	401
306.80027	500375431	488	406.16093	504281901	401
306.80027	500375431	503	406.16093	504284018	401
306.80027	500375431	514	406.16093	5801802888	401
306.80600	504033938	458	406.16093	5801802903	401
306.80600	504033938	467	406.16093	5801804155	401
306.80601	504033939	458	406.16094	504273184	401
306.80601	504033939	467	406.16094	5801609147	401
306.80602	504016519	467	406.16095	504273185	401
306.80603	504016485	467	406.16095	5801609160	401
306.80604	504017160	467	406.16096	504258162	401
306.80605	504017159	467	406.16096	5801606287	401
306.80606	504016124	467	406.16865	2997106	368
306.80607	504016123	467	406.16865	500316865	368
400.00001	500326871	350	406.17137	500042694	375
400.01900	93806655	342	406.17137	500317137	375
400.01900	93807247	342	406.17138	500042693	375
400.01901	93807247	342	406.17138	8142601	375
400.02000	500326870	350	406.18089	5801691386	412
400.02000	500326870	355	406.18090	5801691384	412
400.02001	500332454	350	406.18091	5801692254	413
400.02001	500332454	355	406.18092	5801692253	413
406.01948	42092364	420	406.18093	5801938050	407
406.02000	2997103	368	406.18093	5801938050	412
406.02000	8142590	368	406.18094	5801692865	413
406.02001	98464670	368	406.18095	5801692867	413
406.03510	93926823	342	406.18096	5801692850	413
406.03511	93926824	342	406.18097	5801692854	413
406.03513	93939908	342	406.18098	5801692828	413
406.03514	93939907	342	406.18099	5801692841	413
406.03515	93939909	342	406.18100	5801690583	412
406.03850	93934203	342	406.18101	5801690585	412
406.03850	93936924	342	406.18102	5801690586	412
406.03851	93934202	342	406.18103	5801690588	412
406.03851	93936925	342	406.18104	5801690590	412
406.05627	500389853	439	406.18105	5801690628	412



406.19048	42348003	420	406.43033	98499858	439
406.33900	504009774	350	406.43034	98473849	368
406.33905	2997500	349	406.43034	98473849	426
406.33905	500333905	349	406.43034	98473849	439
406.33907	2997499	349	406.66100	3799217	449
406.33907	500333907	349	406.66101	98480268	449
406.33909	2997493	349	406.66102	98480269	449
406.33909	500054914	349	406.66103	98459188	449
406.33909	504099353	349	406.70090	504281887	395
406.33910	2997495	349	406.70090	5801797763	395
406.33910	504099351	349	406.70090	5801797825	395
406.33920	500326836	349	406.70091	504258213	395
406.33921	500326835	349	406.70091	504281888	395
406.33922	504099511	349	406.70091	5801797764	395
406.33922	504099511	355	406.70091	5801797858	395
406.33922	504099511	358	406.70091	5801797941	395
406.33923	504099512	349	406.70092	504273193	395
406.33923	504099512	355	406.70092	504273193	401
406.33923	504099512	358	406.70092	504284010	395
406.36915	2997123	342	406.70092	504284010	401
406.36915	93936913	342	406.70093	504273199	395
406.36915	93938863	342	406.70093	504273199	401
406.36915	93941625	342	406.70093	504284009	395
406.38450	2997105	439	406.70093	504284009	401
406.38450	98438450	439	406.70094	504258137	396
406.39189	3802743	355	406.70094	504272598	396
406.39189	5801255055	355	406.70095	504258138	396
406.39190	3802001	355	406.70095	504272597	396
406.39190	5801255053	355	406.70096	500380066	382
406.39191	504245477	355	406.70096	500380066	387
406.39192	504245479	355	406.70096	500380066	392
406.39193	504245478	355	406.70096	500380066	396
406.40090	5801529742	361	406.70096	500383459	382
406.40090	5801772690	361	406.70096	500383459	387
406.40090	5802510213	361	406.70096	500383459	392
406.40091	5801605499	362	406.70096	500383459	396
406.40093	5801629792	362	406.70096	504042191	382
406.40094	5801629789	362	406.70096	504042191	387
406.40095	5801582711	362	406.70096	504042191	392
406.40096	5801582700	362	406.70096	504042191	396
406.40097	5801603636	362	406.70096	504258139	382
406.40098	5801630222	362	406.70096	504258139	387
406.40099	5801541041	361	406.70096	504258139	392
406.40100	5801541042	361	406.70096	504258139	396
406.40101	5801627043	361	406.70096	504284012	382
406.40101	5801627396	361	406.70096	504284012	387
406.40102	5801627054	361	406.70096	504284012	392
406.41090	5801350675	358	406.70096	504284012	396
406.41091	5801362619	358	406.70097	504273162	396
406.41092	5801362626	359	406.70097	504273162	401
406.41093	5801350677	359	406.70098	504274012	396
406.41094	5801362625	359	406.70098	504274012	401
406.41095	5801350681	359	406.70099	504274013	396
406.41096	5801339946	359	406.70099	504274013	401
406.41097	5801339976	359	406.71090	5801696201	407
406.43031	2997104	426	406.71091	5801690552	407
406.43031	8143031	426	406.71092	5801690553	407
406.43032	2997152	426	406.71092	5801693353	407
406.43032	2997152	439	406.71093	5801693457	407
406.43032	8143032	426	406.71094	5801693456	407
406.43032	8143032	439	406.71095	5801693491	407
406.43033	8143033	426	406.71096	5801693487	407
406.43033	8143033	439	406.71097	5801693556	407
406.43033	98499858	426	406.71098	5801693540	407

ALL ITEMS MENTIONED IN OUR CATALOGUE ARE NOT ORIGINAL PARTS BUT PERFECTLY INTERCHANGEABLE WITH THEM.

GOVERNING LEGISLATIONS FOR THE SALE OF OUR PRODUCTS DIFFER IN EACH COUNTRY.

INFRINGEMENTS, IF ANY, OF LOCAL LEGISLATIONS ARE RESPONSIBILITY OF THE RETAILER IN THE COUNTRY OF FINAL DISTRIBUTION.



406.71099	5801692884	407	406.90080	504186932	503
406.71100	5801693423	408	406.90080	504284316	477
406.71101	5801693424	408	406.90080	504284316	503
406.71102	5801693428	408	406.90080	5801603586	477
406.71103	5801693429	408	406.90080	5801603586	503
406.74676	504065982	459	406.90081	504186929	488
406.74676	504065982	468	406.90081	504186929	514
406.74677	504074676	459	406.90081	504284315	488
406.74677	504074676	468	406.90081	504284315	514
406.75090	2997370	381	406.90081	5801603578	488
406.75090	42554000	381	406.90081	5801603578	514
406.75090	504027613	381	406.90081	5801603597	488
406.75091	2997638	382	406.90081	5801603597	514
406.75091	504027614	382	406.90082	504190780	478
406.75093	504043051	382	406.90082	504190780	488
406.75093	504043051	387	406.90083	504190781	478
406.75093	504043051	392	406.90083	504190781	488
406.75093	504043052	382	406.90084	504190747	478
406.75093	504043052	387	406.90084	504190747	488
406.75093	504043052	392	406.90085	504186928	488
406.75093	504102117	382	406.90085	504186928	514
406.75093	504102117	387	406.90085	504287143	488
406.75093	504102117	392	406.90085	504287143	514
406.78090	504060073	453	406.90086	504186932	477
406.78091	504091076	453	406.90086	504186932	504
406.78092	504091075	453	406.90086	504284316	477
406.79090	504221272	498	406.90086	504284316	504
406.79091	504221321	498	406.90087	504190697	478
406.79092	504221320	498	406.90087	504190697	489
406.80100	504065985	459	406.90088	504190699	478
406.80100	504065985	468	406.90088	504190699	489
406.80101	504065984	459	406.90089	504190700	478
406.80101	504065984	468	406.90089	504190700	489
406.83942	500380102	458	406.90090	504186929	488
406.83942	500380102	468	406.90090	504186929	514
406.83943	500380104	458	406.90090	504284315	488
406.83943	500380104	468	406.90090	504284315	514
406.83944	500380095	382	406.90090	5801603578	488
406.83944	500380095	387	406.90090	5801603578	514
406.83944	500380095	392	406.90090	5801603597	488
406.83944	500380095	459	406.90090	5801603597	514
406.83944	500380095	468	406.90091	504186932	478
406.83944	504042188	382	406.90091	504186932	504
406.83944	504042188	387	406.90091	504284316	478
406.83944	504042188	392	406.90091	504284316	504
406.83944	504042188	459	406.90091	5801603586	478
406.83944	504042188	468	406.90091	5801603586	504
406.83945	500380094	382	406.90092	504187294	478
406.83945	500380094	387	406.90092	504187294	489
406.83945	500380094	392	406.90092	504187294	505
406.83945	500380094	459	406.90092	504187294	515
406.83945	500380094	468	406.90093	504187339	478
406.83945	504042187	382	406.90093	504187339	489
406.83945	504042187	387	406.90093	504187339	505
406.83945	504042187	392	406.90093	504187339	515
406.83945	504042187	459	406.90094	504187426	478
406.83945	504042187	468	406.90094	504187426	489
406.83946	500383946	468	406.90094	504187426	505
406.83946	504103125	468	406.90094	504187426	515
406.83947	500383947	459	406.90095	504187427	478
406.83947	504103112	459	406.90095	504187427	489
406.83948	504103124	468	406.90095	504187427	505
406.83949	504103111	459	406.90095	504187427	515
406.90080	504186932	477	406.90096	504187506	479



406.90096	504187506	489	406.92090	5802055590	515
406.90096	504187506	505	406.92090	5802055590	515
406.90096	504187506	515	406.92090	5802062276	515
406.90097	504187507	479	406.92090	5802067033	515
406.90097	504187507	489	406.93081	5802055591	504
406.90097	504187507	505	406.93081	5802066514	504
406.90097	504187507	515	406.93086	5802055591	504
406.90098	504173478	479	406.93086	5802066514	504
406.90098	504173478	489	406.93091	5802055591	504
406.90098	504173478	505	406.93091	5802066514	504
406.90098	504173478	515	416.00011	5006182631	528
406.90099	504173477	479	416.00020	504105684	530
406.90099	504173477	489	416.00030	504097988	530
406.90099	504173477	505	416.00060	5006218166	529
406.90099	504173477	515	416.00061	5006218166	529
406.90100	504188129	489	416.00062	93168568	529
406.90100	504188129	505	416.00067	99442399	529
406.90101	504188130	489	416.00070	5006221163	529
406.90101	504188130	505	506.00000	98472983	426
406.90102	500380111	459	506.00000	98472983	439
406.90102	500380111	468	506.00000	98473011	426
406.90102	500380111	479	506.00000	98473011	439
406.90102	500380111	490	506.00001	98472979	427
406.90102	500380111	505	506.00001	98472979	439
406.90102	500380111	515	506.00001	98473007	427
406.90102	504032325	459	506.00001	98473007	439
406.90102	504032325	468	506.00002	2996671	427
406.90102	504032325	479	506.00002	2996671	439
406.90102	504032325	490	506.00002	504132249	427
406.90102	504032325	505	506.00002	504132249	439
406.90102	504032325	515	506.00003	93193197	427
406.90102	504194669	459	506.00003	93193197	440
406.90102	504194669	468	506.00004	93193198	427
406.90102	504194669	479	506.00004	93193198	440
406.90102	504194669	490	506.00005	42548403	427
406.90102	504194669	505	506.00005	42548403	440
406.90102	504194669	515	506.00005	93193199	427
406.90103	504135514	401	506.00005	93193199	440
406.90103	504135514	479	506.00009	98472977	427
406.90103	504135514	490	506.00009	98472977	440
406.90103	504135514	505	506.00010	98472982	427
406.90103	504135514	516	506.00010	98472982	440
406.90104	504187939	479	506.00011	2996670	427
406.90105	504187940	479	506.00011	2996670	440
406.90106	-	479	506.00011	504132248	427
406.90107	-	479	506.00011	504132248	440
406.90108	504008290	479	506.00011	98472987	427
406.90108	504194532	479	506.00011	98472987	440
406.90109	504194533	479	506.00012	504132244	428
406.92070	5801562167	504	506.00012	504132244	440
406.92070	5801562167	514	506.00012	98472975	428
406.92071	5801562166	504	506.00012	98472975	440
406.92071	5801562166	514	506.00013	504132243	428
406.92072	5801562137	504	506.00013	504132243	440
406.92072	5801562137	514	506.00013	98472974	428
406.92073	5801584082	516	506.00013	98472974	440
406.92074	5801584081	516	506.00016	93190976	428
406.92075	504135532	516	506.00016	93190976	441
406.92076	504135530	516	506.00017	93190970	428
406.92077	5801974516	504	506.00017	93190970	441
406.92077	5801974516	514	506.00018	93190973	428
406.92081	5802055590	514	506.00018	93190973	441
406.92085	5802055590	515	506.19048	8123386	420
406.92085	5802067261	515	506.19048	98424107	420

ALL ITEMS MENTIONED IN OUR CATALOGUE ARE NOT ORIGINAL PARTS BUT PERFECTLY INTERCHANGEABLE WITH THEM.

GOVERNING LEGISLATIONS FOR THE SALE OF OUR PRODUCTS DIFFER IN EACH COUNTRY.

INFRINGEMENTS, IF ANY, OF LOCAL LEGISLATIONS ARE RESPONSIBILITY OF THE RETAILER IN THE COUNTRY OF FINAL DISTRIBUTION.



506.33000	98424105	368	506.70101	504369979	396
506.35100	93936853	343	506.70101	504369979	401
506.35101	93936852	343	506.70101	5801341206	396
506.35102	93928072	343	506.70101	5801341206	401
506.35102	93936855	343	506.70101	5801580261	396
506.35103	93928073	343	506.70101	5801580261	401
506.35103	93936854	343	506.88886	98472976	429
506.35104	93160520	343	506.88886	98472976	442
506.35104	93160521	343	506.88887	504076983	429
506.35105	-	343	506.88887	504076983	442
506.38094	500325748	350	506.88887	98472986	429
506.38094	504056893	350	506.88887	98472986	442
506.38095	500325747	350	506.88887	98473012	429
506.38095	504056898	350	506.88887	98473012	442
506.38096	500325709	350	506.88888	98472981	429
506.38096	500325711	350	506.88888	98472981	442
506.38096	504056878	350	506.88888	98473008	429
506.38097	500325708	350	506.88888	98473008	442
506.38097	500325710	350	506.90098	504370055	479
506.38097	504056864	350	506.90098	504370055	498
506.38098	500325726	350	506.90098	5801336298	479
506.38099	500325725	350	506.90098	5801336298	498
506.38100	500371327	350	506.90098	5801580230	479
506.38101	2997613	351	506.90098	5801580230	498
506.38101	500371329	351	506.90099	504370048	479
506.39496	5801367641	356	506.90099	504370048	498
506.39496	5801755754	356	506.90099	5801336285	479
506.39497	5801367608	356	506.90099	5801336285	498
506.39497	5801755709	356	506.90100	504150527	490
506.39498	5801367568	356	506.90100	504369961	490
506.39498	5801736696	356	506.90100	580176196	490
506.39499	5801367571	356	506.90101	504150526	490
506.39499	5801736705	356	506.90101	504369910	490
506.39499	5802032045	356	506.90101	580176195	490
506.39500	3801927	356	506.90102	504197878	396
506.39501	3801926	356	506.90102	504197878	402
506.39502	3801929	356	506.90102	504197878	480
506.39503	3801928	356	506.90102	504197878	490
506.40215	93190971	428	506.90103	504197879	396
506.40215	93190971	441	506.90103	504197879	402
506.40216	93190977	428	506.90103	504197879	480
506.40216	93190977	441	506.90103	504197879	490
506.40217	93190974	428	506.90104	504158975	396
506.40217	93190974	441	506.90104	504158975	402
506.40218	93193161	429	506.90104	504158975	480
506.40218	93193161	441	506.90104	504158975	490
506.40219	2997156	429	506.90105	504158974	396
506.40219	2997156	441	506.90105	504158974	402
506.40219	93193202	429	506.90105	504158974	480
506.40219	93193202	441	506.90105	504158974	490
506.40220	93193203	429	506.90106	504158977	397
506.40220	93193203	442	506.90106	504158977	402
506.40220	93193206	429	506.90106	504158977	480
506.40220	93193206	442	506.90106	504158977	490
506.40500	5801552553	362	506.90107	504158976	397
506.40500	5802028037	362	506.90107	504158976	402
506.40501	5801552552	362	506.90107	504158976	480
506.40501	5802028036	362	506.90107	504158976	490
506.70100	504369995	396	506.90108	504168236	480
506.70100	504369995	401	506.90108	504168236	490
506.70100	5801341207	396	506.90108	5801765379	480
506.70100	5801341207	401	506.90108	5801765379	490
506.70100	5801580263	396	506.90109	504168244	480
506.70100	5801580263	401	506.90109	504168244	491



506.90110	504224428	480	806.40008	5801530197	363
506.90110	504224428	491	806.40008	5801811665	363
506.90110	5801806044	480	806.40009	5801530199	363
506.90110	5801806044	491	806.40009	5801811680	363
506.90111	504158947	481	806.40010	5801565760	363
506.90111	504158947	491	806.40010	5801812254	363
506.90111	504369798	481	806.40011	5801540269	363
506.90111	504369798	491	806.40012	5801540271	363
506.90112	504158943	480	806.90361	-	491
506.90112	504158943	491	806.90362	-	491
506.90113	504158937	480	806.90382	41272198	491
506.90113	504158937	491	806.92301	5801592114	492
506.90114	504158951	481	806.92301	5801592114	516
506.90114	504158951	491	806.92302	5801592119	492
506.90114	504369796	481	806.92302	5801592119	516
506.90114	504369796	491	806.92304	5801672866	492
606.92300	5801592113	491	806.92304	5801672866	516
606.92300	5801592113	516	806.92305	5801673301	516
606.93600	5801698782	506	806.92308	5801735386	492
606.93601	5801698762	506	806.92309	5801735398	492
706.35100	1902779	343	806.93602	5801698798	506
706.38500	504107239	442	806.93603	5801698838	506
706.38501	2995675	442	806.93604	5801698793	506
706.39100	2994472	351	806.93605	5801698846	506
706.39100	2994472	356	906.09900	5949782808	525
706.39100	2997108	351	906.09901	5949782807	525
706.39100	2997108	356	906.70180	504056033	454
706.40100	500051520	362	906.70180	504056033	459
706.43400	2995676	429	906.70181	504056034	454
706.43400	93162831	429	906.70181	504056034	459
706.43401	500337805	429	906.70181	504203478	454
706.43402	504107220	430	906.70181	504203478	459
706.60201	1908138	368	906.71180	5801690105	408
706.60201	1908138	375	906.71180	5801690105	413
706.66100	98445371	449	906.71180	5802055522	408
706.70600	504056838	459	906.71180	5802055522	413
706.70600	504056838	481	906.71181	5801690102	408
706.70600	504089372	459	906.71181	5801690102	413
706.70600	504089372	481	906.71181	5802055523	408
706.75300	504061726	382	906.71181	5802055523	413
706.75300	504061726	387	906.75280	504060280	382
706.75300	504061726	397	906.75280	504060280	387
706.75300	504061726	402	906.75280	504060280	392
706.80700	504042824	469	906.75280	504060280	397
706.90800	504146434	491	906.75280	504060280	402
706.90800	504146530 con staffe	491	906.75280	504116074	382
706.92100	5801715565	516	906.75280	504116074	387
706.92100	5801715570 con staffe	516	906.75280	504116074	392
706.93200	5801715566	506	906.75280	504116074	397
806.03651	41225781	469	906.75280	504116074	402
806.03652	41225782	469	906.75281	504060281	382
806.03801	-	469	906.75281	504060281	387
806.03802	-	469	906.75281	504060281	392
806.27275	500327275	351	906.75281	504060281	397
806.27275	500348517	351	906.75281	504060281	402
806.40000	5801808067	362	906.75281	504116073	382
806.40001	5801808084	362	906.75281	504116073	387
806.40002	5801521532	362	906.75281	504116073	392
806.40003	5801521533	362	906.75281	504116073	397
806.40004	5801521540	363	906.75281	504116073	402
806.40005	5801521541	363	906.75282	504027559	368
806.40006	5801565740	363	906.75282	504027559	375
806.40006	5801811471	363	906.75282	504027559	379
806.40007	5801811189	363	906.75282	504027559	382

ALL ITEMS MENTIONED IN OUR CATALOGUE ARE NOT ORIGINAL PARTS BUT PERFECTLY INTERCHANGEABLE WITH THEM.

GOVERNING LEGISLATIONS FOR THE SALE OF OUR PRODUCTS DIFFER IN EACH COUNTRY.

INFRINGEMENTS, IF ANY, OF LOCAL LEGISLATIONS ARE RESPONSIBILITY OF THE RETAILER IN THE COUNTRY OF FINAL DISTRIBUTION.



906.75282	504027559	387	1006.00005	8142610	379
906.75282	504027559	392	1006.00005	8142610	430
906.75282	504027559	397	1006.00005	8142610	443
906.75282	504027559	402	1006.00006	3798587	430
906.75282	504027559	408	1006.00006	3798587	443
906.75282	504027559	413	1006.00006	3798587	450
906.75282	504116084	368	1006.00007	3798583	450
906.75282	504116084	375	1006.00008	3798586	369
906.75282	504116084	379	1006.00008	3798586	375
906.75282	504116084	382	1006.00008	3798586	430
906.75282	504116084	387	1006.00008	3798586	443
906.75282	504116084	392	1006.00008	3798586	450
906.75282	504116084	397	1006.00008	8142607	369
906.75282	504116084	402	1006.00008	8142607	375
906.75282	504116084	408	1006.00008	8142607	430
906.75282	504116084	413	1006.00008	8142607	443
906.75283	504027560	368	1006.00008	8142607	450
906.75283	504027560	375	1006.10241	41032513	443
906.75283	504027560	379	1006.10241	41210241	443
906.75283	504027560	382	1006.10241	42559148	443
906.75283	504027560	387	1006.18000	504043817	382
906.75283	504027560	392	1006.18000	504043817	387
906.75283	504027560	397	1006.18000	504043817	392
906.75283	504027560	402	1006.18000	504043817	397
906.75283	504027560	408	1006.18001	504043819	388
906.75283	504027560	413	1006.18001	504043819	393
906.75283	504116083	368	1006.25033	93924823	343
906.75283	504116083	375	1006.25034	93924822	343
906.75283	504116083	379	1006.25035	93925035	343
906.75283	504116083	382	1006.25036	93925036	343
906.75283	504116083	387	1006.25037	93828917	343
906.75283	504116083	392	1006.25037	93924973	343
906.75283	504116083	397	1006.25038	93928272	343
906.75283	504116083	402	1006.28934	42533495	430
906.75283	504116083	408	1006.28934	42533495	443
906.75283	504116083	413	1006.28934	42559052	430
906.80162	504096162	469	1006.28934	42559052	443
906.80163	504096163	469	1006.33602	42559053	431
906.80163	504203397	469	1006.34400	500337600	351
906.92190	5801546918	517	1006.34401	500333817	351
906.92191	5801552904	517	1006.40100	5801630551	363
906.93180	5801564804	499	1006.40101	5801620745	363
906.93180	5801564804	506	1006.40102	5801618728	363
906.93181	5801564805	499	1006.40103	5801618730	363
906.93181	5801564805	506	1006.40104	5801618741	363
1001.00001	42533556	434	1006.40105	5801605084	363
1001.00001	42533556	446	1006.40106	5801512513	364
1001.00001	42559051	434	1006.40107	5801512484	364
1001.00001	42559051	446	1006.40108	5801513990	364
1006.00002	98452368	430	1006.40109	5801549124	364
1006.00002	98452368	442	1006.60029	2997187	369
1006.00003	98452333	430	1006.60029	2997187	383
1006.00003	98452333	442	1006.60029	2997187	431
1006.00004	3798584	375	1006.60029	2997187	443
1006.00004	3798584	379	1006.60029	98416236	369
1006.00004	3798584	430	1006.60029	98416236	383
1006.00004	3798584	443	1006.60029	98416236	431
1006.00004	8142611	375	1006.60029	98416236	443
1006.00004	8142611	379	1006.70100	500380112	383
1006.00004	8142611	430	1006.70100	500380112	388
1006.00004	8142611	443	1006.70101	504329077	402
1006.00005	3798585	379	1006.70101	504329077	413
1006.00005	3798585	430	1006.70102	504329078	402
1006.00005	3798585	443	1006.70102	504329078	413



1006.70103	504032791	383	1006.90100	504022657	481
1006.70103	504032791	388	1006.90100	504022657	492
1006.70103	504032791	393	1006.90101	504022658	481
1006.70103	504032791	397	1006.90101	504022658	492
1006.70103	504032791	403	1006.90102	41213731	481
1006.70104	504049432	383	1006.90102	41213731	492
1006.70104	504049432	388	1006.90103	41213729	481
1006.70104	504049432	393	1006.90103	41213729	492
1006.70104	504049432	397	1006.90104	41213727	481
1006.70104	504049432	403	1006.90104	41213727	492
1006.70104	504049432	408	1006.90105	41213725	481
1006.70104	504049432	413	1006.90105	41213725	492
1006.70105	504032799	383	1006.90106	98474429	369
1006.70105	504032799	388	1006.90106	98474429	450
1006.70105	504032799	393	1006.90106	98474429	454
1006.70105	504032799	397	1006.90106	98474429	460
1006.70105	504032799	403	1006.90106	98474429	470
1006.70105	504032799	408	1006.90106	98474429	481
1006.70105	504032799	413	1006.90106	98474429	493
1006.70106	504032787	383	1006.90106	98474429	499
1006.70106	504032787	388	1006.90106	98474429	507
1006.70106	504032787	393	1006.90106	98474429	517
1006.70106	504032787	397	1006.90107	4605163	372
1006.70106	504032787	403	1006.90107	4605163	377
1006.70107	504329073	403	1006.90107	4605163	380
1006.70107	504329073	414	1006.90107	4605163	385
1006.70108	504329074	403	1006.90107	4605163	390
1006.70108	504329074	414	1006.90107	4605163	399
1006.70110	504329071	414	1006.90107	4605163	404
1006.70532	504242345	460	1006.90107	4605163	409
1006.70532	504242345	481	1006.90107	4605163	415
1006.70532	504242345	506	1006.90107	4605163	434
1006.70533	504242346	460	1006.90107	4605163	446
1006.70533	504242346	481	1006.90107	4605163	451
1006.70533	504242346	506	1006.90107	4605163	455
1006.70604	500368694	460	1006.90107	4605163	463
1006.70604	500368694	469	1006.90107	4605163	473
1006.70604	500368694	481	1006.90107	4605163	484
1006.70604	500368694	492	1006.90107	4605163	495
1006.70604	500368694	506	1006.90107	4605163	500
1006.70604	500368694	517	1006.90107	4605163	509
1006.70604	504306106	460	1006.90107	4605163	519
1006.70604	504306106	469	1006.90108	500396838	482
1006.70604	504306106	481	1006.90108	500396838	493
1006.70604	504306106	492	1006.90108	500396838	507
1006.70604	504306106	506	1006.90108	500396838	517
1006.70604	504306106	517	1006.90109	4784894	372
1006.78994	41027657	454	1006.90109	4784894	377
1006.78995	41027658	454	1006.90109	4784894	380
1006.78996	504097996	454	1006.90109	4784894	385
1006.78997	504097971	454	1006.90109	4784894	390
1006.80177	504017177	469	1006.90109	4784894	399
1006.80178	504017178	469	1006.90109	4784894	404
1006.80540	504211437	469	1006.90109	4784894	410
1006.80540	504211437	492	1006.90109	4784894	415
1006.80540	504211437	517	1006.90109	4784894	434
1006.80541	504211438	469	1006.90109	4784894	446
1006.80541	504211438	492	1006.90109	4784894	451
1006.80541	504211438	517	1006.90109	4784894	455
1006.80580	504017580	469	1006.90109	4784894	463
1006.80696	2997670	463	1006.90109	4784894	473
1006.80696	2997670	473	1006.90109	4784894	484
1006.80696	41213696	463	1006.90109	4784894	495
1006.80696	41213696	473	1006.90109	4784894	500

ALL ITEMS MENTIONED IN OUR CATALOGUE ARE NOT ORIGINAL PARTS BUT PERFECTLY INTERCHANGEABLE WITH THEM.

GOVERNING LEGISLATIONS FOR THE SALE OF OUR PRODUCTS DIFFER IN EACH COUNTRY.

INFRINGEMENTS, IF ANY, OF LOCAL LEGISLATIONS ARE RESPONSIBILITY OF THE RETAILER IN THE COUNTRY OF FINAL DISTRIBUTION.



1006.90109	4784894	509	1500.00000	-	405
1006.90109	4784894	519	1500.00000	-	410
1006.90110	504194581	398	1500.00000	-	415
1006.90110	504194581	403	1500.00000	-	464
1006.90110	504194581	460	1500.00000	-	474
1006.90110	504194581	470	1500.00000	-	485
1006.90110	504194581	482	1500.00000	-	496
1006.90110	504194581	493	1500.00001	-	399
1006.90110	504194581	507	1500.00001	-	405
1006.90110	504194581	517	1500.00001	-	410
1006.90187	504171187	482	1500.00001	-	415
1006.90187	504171187	493	1500.00001	-	464
1006.90483	504173483	398	1500.00001	-	474
1006.90483	504173483	482	1500.00001	-	485
1006.90483	504173483	493	1500.00001	-	496
1006.90487	504173487	482	1500.00004	-	357
1006.90487	504173487	493	1500.00004	-	359
1006.90916	504256916	482	1500.00004	-	365
1106.40080	5801529858	364	1500.00005	-	357
1106.40081	5801529859	364	1500.00005	-	359
1106.40082	5801562215	364	1500.00005	-	365
1106.40083	5801562216	364	1503.45100	-	485
1106.48043	42348001	420	1503.45100	-	485
1206.42427	8142427	443	1503.45100	-	485
1206.42428	8142428	443	1503.45100	-	485
1206.43812	8143812	369	1503.45100	-	496
1206.43812	8143812	379	1503.45100	-	496
1206.43813	8143813	369	1503.45100	-	496
1206.43813	8143813	379	1503.45100	-	496
1406.04802	1908809	444	1503.45100	-	509
1406.04802	504232501	444	1503.45100	-	509
1406.04803	1908810	444	1503.45100	-	510
1406.04803	504232504	444	1503.45100	-	510
1406.38004	500339322	351	1503.45100	-	520
1406.38005	500339321	351	1503.45100	-	520
1406.60060	-	369	1503.45100	-	520
1406.60061	-	369	1503.45100	-	520
1406.75005	504139861	383	1503.45101	-	485
1406.75005	504139861	388	1503.45101	-	485
1406.75005	504139861	393	1503.45101	-	485
1406.75006	504139860	383	1503.45101	-	485
1406.75006	504139860	388	1503.45101	-	496
1406.75006	504139860	393	1503.45101	-	496
1406.80094	500370048	470	1503.45101	-	496
1406.80094	504045193	470	1503.45101	-	496
1406.80095	500370049	470	1503.45101	-	509
1406.80095	504045194	470	1503.45101	-	509
1406.80980	504044980	470	1503.45101	-	510
1406.80980	504211611	470	1503.45101	-	510
1406.80980	5801847591	470	1503.45101	-	520
1406.80981	504044981	470	1503.45101	-	520
1406.80981	504211612	470	1503.45101	-	520
1406.80981	5801847596	470	1503.45101	-	520
1406.80982	504022500	470	1506.39002	69500805	357
1406.80982	504081118	470	1506.39003	69500806	357
1406.80983	504022499	470	1506.40601	5801557592	366
1406.80983	504081120	470	1506.40602	5801557593	366
1406.80984	504022497	470	1506.92000	5802000573	485
1406.80985	504022498	470	1506.92000	5802000573	496
1406.96753	500396753	444	1506.92000	5802000573	509
1406.96754	500396754	444	1506.92000	5802000573	520
1406.96755	3799162	444	1506.92001	5802062689	485
1406.96756	3799163	444	1506.92001	5802062689	496
1500.00000	-	399	1506.92001	5802062689	509



1506.92001	5802062689	520	1606.35013	500307755	352
1506.92002	5802000767	485	1606.35914	500320425	351
1506.92002	5802000767	496	1606.35914	500320427	351
1506.92002	5802000767	509	1606.35915	500320426	351
1506.92002	5802000767	520	1606.35915	500320428	351
1506.92003	5802000568	485	1606.35916	504104467	351
1506.92003	5802000568	496	1606.35917	504104465	351
1506.92003	5802000568	509	1606.35920	500328136	351
1506.92003	5802000568	520	1606.35921	500328137	351
1506.92004	5802000770	485	1606.35922	500355252	352
1506.92004	5802000770	496	1606.35923	500355253	352
1506.92004	5802000770	510	1606.35924	504104575	352
1506.92004	5802000770	520	1606.35925	504104577	352
1506.92005	5802000570	485	1606.35926	504104580	352
1506.92005	5802000570	496	1606.35927	504104582	352
1506.92005	5802000570	510	1606.35928	500316961	352
1506.92005	5802000570	520	1606.35929	500316960	352
1506.92006	5802000772	485	1606.35930	500319558	353
1506.92006	5802000772	496	1606.35931	500319559	353
1506.92006	5802000772	510	1606.36360	98460036	431
1506.92006	5802000772	520	1606.36361	98460038	431
1506.92007	5802055273	485	1606.36362	98419235	431
1506.92007	5802055273	496	1606.36362	98419235	444
1506.92007	5802055273	510	1606.36363	98419234	431
1506.92007	5802055273	520	1606.36363	98419234	444
1506.92008	5801637201	510	1606.36364	500368110	431
1506.92008	5801637201	520	1606.36364	500368110	444
1506.92009	5801637199	510	1606.36365	500368111	431
1506.92009	5801637199	520	1606.36365	500368111	444
1506.92010	5801637702	510	1606.39200	69500010	356
1506.92010	5801637702	521	1606.39201	69500013	356
1506.92011	5801637182	510	1606.39202	3801915	356
1506.92011	5801637182	521	1606.39203	3801914	356
1506.92012	5801757328	510	1606.40600	5801473749	365
1506.92012	5801757328	521	1606.40601	5801473750	365
1506.92013	5802055272	510	1606.40602	5801585151	364
1506.92013	5802055272	521	1606.40602	5801874639	364
1506.92014	5801757326	510	1606.40603	5801585146	364
1506.92014	5801757326	521	1606.40603	5801874640	364
1506.92100	42575877	510	1606.40604	5801587021	365
1506.92100	42575877	510	1606.40605	5801523220	366
1506.92100	42575877	510	1606.40606	5801523221	366
1506.92100	42575877	510	1606.40607	5801823572	364
1506.92100	42575877	520	1606.40608	5801823334	364
1506.92100	42575877	521	1606.40609	5801610737	364
1506.92100	42575877	521	1606.40610	5801610735	364
1506.92100	42575877	521	1606.40611	-	365
1506.92101	42575315	510	1606.41030	695000590	359
1506.92101	42575315	510	1606.41031	695000591	359
1506.92101	42575315	510	1606.41032	5801377880	359
1506.92101	42575315	520	1606.41033	5801377881	359
1506.92101	42575315	521	1606.41034	5801375415	359
1506.92101	42575315	521	1606.41035	5801375416	359
1601.50013	-	460	1606.48440	4861793	432
1601.50013	-	471	1606.48440	4861793	445
1606.05102	500305102	431	1606.48441	4861794	432
1606.05102	500305102	445	1606.48441	4861794	445
1606.05103	500305103	431	1606.48480	98449181	444
1606.05103	500305103	445	1606.48481	98449182	444
1606.11510	4814863	418	1606.60110	98437475	370
1606.19480	42342171	420	1606.60110	98437475	376
1606.33912	98433912	344	1606.60110	98437475	432
1606.33913	98433913	344	1606.60111	98437476	370
1606.35012	500307754	352	1606.60111	98437476	376

ALL ITEMS MENTIONED IN OUR CATALOGUE ARE NOT ORIGINAL PARTS BUT PERFECTLY INTERCHANGEABLE WITH THEM.

GOVERNING LEGISLATIONS FOR THE SALE OF OUR PRODUCTS DIFFER IN EACH COUNTRY.

INFRINGEMENTS, IF ANY, OF LOCAL LEGISLATIONS ARE RESPONSIBILITY OF THE RETAILER IN THE COUNTRY OF FINAL DISTRIBUTION.



1606.60111	98437476	432	1606.80039	504020193	461
1606.71700	5801738337	408	1606.80039	504020193	472
1606.71700	5801738337	414	1606.80040	41221040	461
1606.75121	500340408	370	1606.80040	41221040	471
1606.75121	500340408	376	1606.80040	41221040	499
1606.75122	500340361	370	1606.80040	42555022	461
1606.75122	500340361	376	1606.80040	42555022	471
1606.75200	500340503	370	1606.80040	42555022	499
1606.75200	500340503	376	1606.80041	41221041	461
1606.75201	500340543	370	1606.80041	41221041	471
1606.75201	500340543	376	1606.80041	41221041	499
1606.75600	504047573	383	1606.80041	42555023	461
1606.75600	504047573	388	1606.80041	42555023	471
1606.75601	504052353	384	1606.80041	42555023	499
1606.75601	504052353	389	1606.80042	504032145	461
1606.75602	504052352	384	1606.80042	504032145	472
1606.75602	504052352	389	1606.80043	504032148	462
1606.75603	504045133	393	1606.80043	504032148	472
1606.75603	504045133	461	1606.80044	504098243 grigio	461
1606.75603	504045133	471	1606.80044	504098243 grigio	471
1606.75604	504055623	393	1606.80044	504250999 nero	461
1606.75604	504055623	461	1606.80044	504250999 nero	471
1606.75604	504055623	471	1606.80045	504098245 grigio	461
1606.75916	500340695	369	1606.80045	504098245 grigio	471
1606.75916	500340695	376	1606.80045	504250991 nero	461
1606.75917	500340696	369	1606.80045	504250991 nero	471
1606.75917	500340696	376	1606.80046	504047265	383
1606.75918	4862220	369	1606.80046	504047265	388
1606.75918	4862220	376	1606.80046	504047265	393
1606.75919	99452662	370	1606.80046	504047265	398
1606.75919	99452662	376	1606.80046	504047265	403
1606.75919	99452662	379	1606.80046	504047265	461
1606.75920	500314717	370	1606.80046	504047265	471
1606.75920	500314717	376	1606.80046	504047265	483
1606.75920	500314717	431	1606.80046	504047265	494
1606.75920	500314717	444	1606.80047	504047264	383
1606.75921	500314716	370	1606.80047	504047264	388
1606.75921	500314716	376	1606.80047	504047264	393
1606.75921	500314716	431	1606.80047	504047264	398
1606.75921	500314716	444	1606.80047	504047264	403
1606.75922	98461649	370	1606.80047	504047264	461
1606.75922	98461649	376	1606.80047	504047264	471
1606.75922	98461649	431	1606.80047	504047264	483
1606.75922	98461649	444	1606.80047	504047264	494
1606.75923	98461648	370	1606.90600	504238093	398
1606.75923	98461648	376	1606.90600	504238093	404
1606.75923	98461648	431	1606.90600	504238093	483
1606.75923	98461648	444	1606.90600	504238093	494
1606.75924	504133023	408	1606.90600	504238093	499
1606.75924	504133023	414	1606.90601	504238117	398
1606.75924	5801573143	408	1606.90601	504238117	404
1606.75924	5801573143	414	1606.90601	504238117	483
1606.75925	504107550	408	1606.90601	504238117	494
1606.75925	504107550	414	1606.90601	504238117	499
1606.75925	5801573145	408	1606.90602	41221039 GRIGIO	461
1606.75925	5801573145	414	1606.90602	41221039 GRIGIO	471
1606.80038	504020189	384	1606.90602	41221039 GRIGIO	483
1606.80038	504020189	389	1606.90602	41221039 GRIGIO	494
1606.80038	504020189	393	1606.90602	504250984 NERO	461
1606.80038	504020189	461	1606.90602	504250984 NERO	471
1606.80038	504020189	472	1606.90602	504250984 NERO	483
1606.80039	504020193	384	1606.90602	504250984 NERO	494
1606.80039	504020193	389	1606.90603	41221029 GRIGIO	461
1606.80039	504020193	393	1606.90603	41221029 GRIGIO	471



1606.90603	41221029 GRIGIO	483	1606.92809	-	409
1606.90603	41221029 GRIGIO	494	1606.92809	-	414
1606.90603	504250958 NERO	461	1606.92809	-	508
1606.90603	504250958 NERO	471	1606.92809	-	518
1606.90603	504250958 NERO	483	1606.92810	-	398
1606.90603	504250958 NERO	494	1606.92810	-	403
1606.90604	42555041	398	1606.92810	-	483
1606.90604	42555041	403	1606.92810	-	494
1606.90604	42555041	483	1606.92810	-	518
1606.90604	42555041	494	1606.92811	-	461
1606.90604	5801755123	398	1606.92811	-	471
1606.90604	5801755123	403	1606.92811	-	483
1606.90604	5801755123	483	1606.92811	-	494
1606.90604	5801755123	494	1606.92811	-	518
1606.90605	42555042	398	1606.92813	5801629859	499
1606.90605	42555042	403	1606.92813	5801754889	499
1606.90605	42555042	483	1606.92814	5801629858	499
1606.90605	42555042	494	1606.92814	5801754888	499
1606.90605	5801755132	398	1606.93900	98433939	344
1606.90605	5801755132	403	1606.93901	98433940	344
1606.90605	5801755132	483	1606.93902	98433941	344
1606.90605	5801755132	494	1606.93903	98433942	344
1606.90606	504181095	398	1706.18000	5801527115	409
1606.90606	504181095	404	1706.18000	5801912787	409
1606.90606	504181095	409	1706.19042	4786977	420
1606.90606	504181095	414	1706.19043	4786978	420
1606.90606	504181095	483	1706.19044	-	420
1606.90606	504181095	494	1706.19045	93017949	420
1606.90607	504181096	483	1706.35120	93936135	344
1606.90607	504181096	494	1706.35121	93936134	344
1606.92798	5801745442	508	1706.35122	-	344
1606.92798	5801745442	518	1706.35123	93926687	344
1606.92799	5801745441	508	1706.35125	93924716	344
1606.92799	5801745441	518	1706.35126	93924717	344
1606.92800	5801745452	409	1706.35127	93924714	344
1606.92800	5801745452	414	1706.35128	93928166	344
1606.92800	5801745452	508	1706.35129	93938673	345
1606.92801	5801745449	409	1706.35130	93926848	345
1606.92801	5801745449	414	1706.35130	93936405	345
1606.92801	5801745449	508	1706.38119	500329761	352
1606.92802	5801572018	507	1706.38120	99489590	352
1606.92802	5801572018	518	1706.38121	99489589	352
1606.92802	5801755107	507	1706.38122	500314228	352
1606.92802	5801755107	518	1706.38123	500314227	352
1606.92803	5801572024	507	1706.60900	98404709	370
1606.92803	5801572024	518	1706.60900	98404709	432
1606.92803	5801755108	507	1706.60900	98404709	445
1606.92803	5801755108	518	1706.60901	98404710	370
1606.92804	5801546522	507	1706.60901	98404710	432
1606.92804	5801546522	518	1706.60901	98404710	445
1606.92805	5801546548	507	1706.60902	500335296	370
1606.92805	5801546548	518	1706.60902	500335296	432
1606.92806	5801572074	508	1706.60902	500335296	445
1606.92806	5801572074	518	1706.60902	98404714	370
1606.92806	5801754885	508	1706.60902	98404714	432
1606.92806	5801754885	518	1706.60902	98404714	445
1606.92807	5801572080	508	1706.60903	98463023	371
1606.92807	5801572080	518	1706.60903	98463023	377
1606.92807	5801754886	508	1706.60903	98463023	379
1606.92807	5801754886	518	1706.60904	98463024	371
1606.92808	-	409	1706.60904	98463024	377
1606.92808	-	414	1706.60904	98463024	379
1606.92808	-	508	1706.60905	98411952	371
1606.92808	-	518	1706.60905	98411952	377

ALL ITEMS MENTIONED IN OUR CATALOGUE ARE NOT ORIGINAL PARTS BUT PERFECTLY INTERCHANGEABLE WITH THEM.

GOVERNING LEGISLATIONS FOR THE SALE OF OUR PRODUCTS DIFFER IN EACH COUNTRY.

INFRINGEMENTS, IF ANY, OF LOCAL LEGISLATIONS ARE RESPONSIBILITY OF THE RETAILER IN THE COUNTRY OF FINAL DISTRIBUTION.



1706.60905	98411952	379	1706.60906	98416419	432
1706.60905	98411952	384	1706.60906	98416419	445
1706.60905	98411952	389	1706.60906	98416419	450
1706.60905	98411952	398	1706.60906	98416419	454
1706.60905	98411952	404	1706.60906	98416419	462
1706.60905	98411952	409	1706.60906	98416419	472
1706.60905	98411952	415	1706.60906	98416419	484
1706.60905	98411952	432	1706.60906	98416419	495
1706.60905	98411952	445	1706.60906	98416419	508
1706.60905	98411952	450	1706.60906	98416419	519
1706.60905	98411952	454	1706.60907	5802132944	371
1706.60905	98411952	462	1706.60907	5802132944	377
1706.60905	98411952	472	1706.60907	5802132944	380
1706.60905	98411952	484	1706.60907	5802132944	384
1706.60905	98411952	495	1706.60907	5802132944	389
1706.60905	98411952	508	1706.60907	5802132944	399
1706.60905	98411952	519	1706.60907	5802132944	404
1706.60905	98416424	371	1706.60907	5802132944	409
1706.60905	98416424	377	1706.60907	5802132944	415
1706.60905	98416424	379	1706.60907	5802132944	432
1706.60905	98416424	384	1706.60907	5802132944	445
1706.60905	98416424	389	1706.60907	5802132944	450
1706.60905	98416424	398	1706.60907	5802132944	455
1706.60905	98416424	404	1706.60907	5802132944	462
1706.60905	98416424	409	1706.60907	5802132944	472
1706.60905	98416424	415	1706.60907	5802132944	484
1706.60905	98416424	432	1706.60907	5802132944	495
1706.60905	98416424	445	1706.60907	5802132944	508
1706.60905	98416424	450	1706.60907	5802132944	519
1706.60905	98416424	454	1706.60907	99476268	371
1706.60905	98416424	462	1706.60907	99476268	377
1706.60905	98416424	472	1706.60907	99476268	380
1706.60905	98416424	484	1706.60907	99476268	384
1706.60905	98416424	495	1706.60907	99476268	389
1706.60905	98416424	508	1706.60907	99476268	399
1706.60905	98416424	519	1706.60907	99476268	404
1706.60906	98411951	371	1706.60907	99476268	409
1706.60906	98411951	377	1706.60907	99476268	415
1706.60906	98411951	379	1706.60907	99476268	432
1706.60906	98411951	384	1706.60907	99476268	445
1706.60906	98411951	389	1706.60907	99476268	450
1706.60906	98411951	398	1706.60907	99476268	455
1706.60906	98411951	404	1706.60907	99476268	462
1706.60906	98411951	409	1706.60907	99476268	472
1706.60906	98411951	415	1706.60907	99476268	484
1706.60906	98411951	432	1706.60907	99476268	495
1706.60906	98411951	445	1706.60907	99476268	508
1706.60906	98411951	450	1706.60907	99476268	519
1706.60906	98411951	454	1706.60908	5802132946	371
1706.60906	98411951	462	1706.60908	5802132946	377
1706.60906	98411951	472	1706.60908	5802132946	380
1706.60906	98411951	484	1706.60908	5802132946	384
1706.60906	98411951	495	1706.60908	5802132946	389
1706.60906	98411951	508	1706.60908	5802132946	399
1706.60906	98411951	519	1706.60908	5802132946	404
1706.60906	98416419	371	1706.60908	5802132946	409
1706.60906	98416419	377	1706.60908	5802132946	415
1706.60906	98416419	379	1706.60908	5802132946	432
1706.60906	98416419	384	1706.60908	5802132946	445
1706.60906	98416419	389	1706.60908	5802132946	450
1706.60906	98416419	398	1706.60908	5802132946	455
1706.60906	98416419	404	1706.60908	5802132946	462
1706.60906	98416419	409	1706.60908	5802132946	472
1706.60906	98416419	415	1706.60908	5802132946	484



1706.60908	5802132946	495	1806.60124	98408394	371
1706.60908	5802132946	508	1806.60124	98408394	433
1706.60908	5802132946	519	1806.60125	8142801	371
1706.60908	99476267	371	1806.60125	8142801	433
1706.60908	99476267	377	1806.60126	8142802	371
1706.60908	99476267	380	1806.60126	8142802	433
1706.60908	99476267	384	1806.60127	98409363	371
1706.60908	99476267	389	1806.60127	98409363	433
1706.60908	99476267	399	1806.60128	98409362	371
1706.60908	99476267	404	1806.60128	98409362	433
1706.60908	99476267	409	1806.60131	99477139	372
1706.60908	99476267	415	1806.60131	99477139	433
1706.60908	99476267	432	1806.60132	8142404	372
1706.60908	99476267	445	1806.60132	8142404	433
1706.60908	99476267	450	1806.60133	98404902	372
1706.60908	99476267	455	1806.60133	98404902	377
1706.60908	99476267	462	1806.60133	98404902	380
1706.60908	99476267	472	1806.60133	98404902	384
1706.60908	99476267	484	1806.60133	98404902	389
1706.60908	99476267	495	1806.60133	98404902	399
1706.60908	99476267	508	1806.60133	98404902	404
1706.60908	99476267	519	1806.60133	98404902	409
1706.80800	-	384	1806.60133	98404902	415
1706.80800	-	389	1806.60133	98404902	433
1706.80800	-	462	1806.60133	98404902	445
1706.80800	-	472	1806.60133	98404902	451
1706.80801	-	384	1806.60133	98404902	455
1706.80801	-	389	1806.60133	98404902	462
1706.80801	-	462	1806.60133	98404902	473
1706.80801	-	472	1806.60133	98404902	484
1706.80802	504052936	384	1806.60133	98404902	495
1706.80802	504052936	389	1806.60133	98404902	508
1706.80802	504052936	462	1806.60133	98404902	519
1706.80802	504052936	472	1806.60134	98484152	372
1801.36000	504021635	353	1806.60134	98484152	377
1801.36000	97169308	353	1806.60134	98484152	380
1806.19020	42343172	421	1806.60134	98484152	384
1806.24015	8143852	432	1806.60134	98484152	389
1806.24015	8143852	462	1806.60134	98484152	399
1806.35012	93902026	345	1806.60134	98484152	404
1806.35012	93926149	345	1806.60134	98484152	409
1806.35012	93940727	345	1806.60134	98484152	415
1806.35014	503645305	345	1806.60134	98484152	433
1806.35014	93930986	345	1806.60134	98484152	445
1806.35015	93926317	345	1806.60134	98484152	451
1806.35017	93926310	345	1806.60134	98484152	455
1806.35018	93926309	345	1806.60134	98484152	462
1806.35020	93933106 (spezzone)	345	1806.60134	98484152	473
1806.35022	93929967	345	1806.60134	98484152	484
1806.35022	93931353	345	1806.60134	98484152	495
1806.35023	93902121	346	1806.60134	98484152	508
1806.36001	504203320	353	1806.60134	98484152	519
1806.36001	504203320	356	1906.19026	2997174	421
1806.36001	504364956	353	1906.19026	4817018	421
1806.36001	504364956	356	1906.19027	2997175	421
1806.44015	8143853	445	1906.19027	4817019	421
1806.44015	8143853	472	1906.19028	2997176	421
1806.60120	8143851	371	1906.19028	4817201	421
1806.60121	8142799	371	1906.19029	2997177	421
1806.60121	8142799	432	1906.19029	4817202	421
1806.60122	8142800	371	1906.20010	500314230	353
1806.60122	8142800	432	1906.20010	504053528	353
1806.60123	98408393	371	1906.20010	504173866	353
1806.60123	98408393	433	1906.20011	500314229	353

ALL ITEMS MENTIONED IN OUR CATALOGUE ARE NOT ORIGINAL PARTS BUT PERFECTLY INTERCHANGEABLE WITH THEM.

GOVERNING LEGISLATIONS FOR THE SALE OF OUR PRODUCTS DIFFER IN EACH COUNTRY.

INFRINGEMENTS, IF ANY, OF LOCAL LEGISLATIONS ARE RESPONSIBILITY OF THE RETAILER IN THE COUNTRY OF FINAL DISTRIBUTION.



1906.20011	504053527	353	1906.60033	2997196	508
1906.20011	504173868	353	1906.60033	2997196	519
1906.39000	42574135	357	1906.60033	98407722	372
1906.39000	504356351	357	1906.60033	98407722	384
1906.39001	42574134	357	1906.60033	98407722	389
1906.39001	504356352	357	1906.60033	98407722	433
1906.60030	2997185	372	1906.60033	98407722	446
1906.60030	2997185	433	1906.60033	98407722	455
1906.60030	98407741	372	1906.60033	98407722	462
1906.60030	98407741	433	1906.60033	98407722	473
1906.60031	2997186	372	1906.60033	98407722	484
1906.60031	2997186	433	1906.60033	98407722	495
1906.60031	98407744	372	1906.60033	98407722	500
1906.60031	98407744	433	1906.60033	98407722	508
1906.60032	2997195	372	1906.60033	98407722	519
1906.60032	2997195	384	1906.60033	99487781	372
1906.60032	2997195	389	1906.60033	99487781	384
1906.60032	2997195	433	1906.60033	99487781	389
1906.60032	2997195	446	1906.60033	99487781	433
1906.60032	2997195	455	1906.60033	99487781	446
1906.60032	2997195	462	1906.60033	99487781	455
1906.60032	2997195	473	1906.60033	99487781	462
1906.60032	2997195	484	1906.60033	99487781	473
1906.60032	2997195	495	1906.60033	99487781	484
1906.60032	2997195	500	1906.60033	99487781	495
1906.60032	2997195	508	1906.60033	99487781	500
1906.60032	2997195	519	1906.60033	99487781	508
1906.60032	98407721	372	1906.60033	99487781	519
1906.60032	98407721	384	1906.90030	504040988	385
1906.60032	98407721	389	1906.90030	504040988	390
1906.60032	98407721	433	1906.90030	504040988	394
1906.60032	98407721	446	1906.90030	504040988	399
1906.60032	98407721	455	1906.90030	504040988	455
1906.60032	98407721	462	1906.90030	504040988	463
1906.60032	98407721	473	1906.90030	504040988	473
1906.60032	98407721	484	1906.90030	504040988	484
1906.60032	98407721	495	1906.90030	504040988	495
1906.60032	98407721	500	1906.90030	504040988	500
1906.60032	98407721	508	1906.90030	504040988	509
1906.60032	98407721	519	1906.90030	504040988	519
1906.60032	99487780	372	1906.90030	504157968	385
1906.60032	99487780	384	1906.90030	504157968	390
1906.60032	99487780	389	1906.90030	504157968	394
1906.60032	99487780	433	1906.90030	504157968	399
1906.60032	99487780	446	1906.90030	504157968	455
1906.60032	99487780	455	1906.90030	504157968	463
1906.60032	99487780	462	1906.90030	504157968	473
1906.60032	99487780	473	1906.90030	504157968	484
1906.60032	99487780	484	1906.90030	504157968	495
1906.60032	99487780	495	1906.90030	504157968	500
1906.60032	99487780	500	1906.90030	504157968	509
1906.60032	99487780	508	1906.90030	504157968	519
1906.60032	99487780	519	1906.90030	5801324907	385
1906.60033	2997196	372	1906.90030	5801324907	390
1906.60033	2997196	384	1906.90030	5801324907	394
1906.60033	2997196	389	1906.90030	5801324907	399
1906.60033	2997196	433	1906.90030	5801324907	455
1906.60033	2997196	446	1906.90030	5801324907	463
1906.60033	2997196	455	1906.90030	5801324907	473
1906.60033	2997196	462	1906.90030	5801324907	484
1906.60033	2997196	473	1906.90030	5801324907	495
1906.60033	2997196	484	1906.90030	5801324907	500
1906.60033	2997196	495	1906.90030	5801324907	509
1906.60033	2997196	500	1906.90030	5801324907	519



1906.90031	504040989	385	2106.43080	98409491	446
1906.90031	504040989	390	2106.43081	8166285	451
1906.90031	504040989	394	2106.70080	98426669	404
1906.90031	504040989	399	2106.80080	41215631	463
1906.90031	504040989	455	2106.80080	41215631	473
1906.90031	504040989	463	2106.80080	41215631	484
1906.90031	504040989	473	2106.80080	41215631	495
1906.90031	504040989	484	2106.92080	41215632	519
1906.90031	504040989	495	2406.36100	98476371	434
1906.90031	504040989	500	2406.48100	98483247	446
1906.90031	504040989	509	2406.60100	500359930	372
1906.90031	504040989	519	2406.60100	98444263	372
1906.90031	504157969	385	2406.60101	500359924	373
1906.90031	504157969	390	2406.60101	98444262	373
1906.90031	504157969	394	2406.75100	504032792	373
1906.90031	504157969	399	2406.75100	504032792	377
1906.90031	504157969	455	2406.75100	504032792	380
1906.90031	504157969	463	2406.75100	504032792	385
1906.90031	504157969	473	2406.75100	504032792	390
1906.90031	504157969	484	2406.75100	504032792	394
1906.90031	504157969	495	2406.75100	504032792	399
1906.90031	504157969	500	2406.75100	504032792	405
1906.90031	504157969	509	2406.75100	504032792	410
1906.90031	504157969	519	2406.75100	504032792	415
1906.90031	5801324893	385	2406.83100	500390551	463
1906.90031	5801324893	390	2406.83100	500390551	473
1906.90031	5801324893	394	3000.02005	98437200	369
1906.90031	5801324893	399	3006.00000	-	373
1906.90031	5801324893	455	3006.00000	-	380
1906.90031	5801324893	463	3006.00000	-	385
1906.90031	5801324893	473	3006.00000	-	390
1906.90031	5801324893	484	3006.00000	-	434
1906.90031	5801324893	495	3006.00000	-	446
1906.90031	5801324893	500	3006.00000	-	474
1906.90031	5801324893	509	3006.00000	-	485
1906.90031	5801324893	519	3006.00001	-	365
1906.96001	2997194	346			
1906.96001	4856064	346			
1906.96001	99485358	346			
1906.96002	2997193	346			
1906.96002	4856063	346			
1906.96002	99485357	346			
1906.96003	2997184	346			
1906.96003	93926735	346			
1906.96003	93941271	346			
1906.96004	2997183	346			
1906.96004	93926734	346			
1906.96004	93941270	346			
2000.00010	-	346			
2000.00011	-	353			
2000.00012	-	434			
2000.00200	99477376	346			
2000.00201	-	346			
2000.00202	-	346			
2000.00203	5801804152	365			
2000.00206	500316950	373			
2000.00211	41027910	434			
2000.00213	41032687	435			
2000.00216	-	435			
2000.00250	93824452	346			
2000.00251	-	347			
2000.00252	-	435			
2106.40080	504359964	365			
2106.43080	98409491	434			
			COS.MA		
			COS.PEL ref.	SIMILAR ref.	PAG
			003092	-	536
			003092	-	540
			003092	-	544
			003092	-	561
			003092	-	573
			003092	-	602
			003092	-	611
			003120	-	536
			003120	-	540
			003120	-	544
			003120	-	561
			003120	-	573
			003120	-	602
			003120	-	611
			003123	-	573
			003123	-	587
			006120	81252286028	551
			006130	81252286027	551
			006132	-	573
			006133	-	573
			011111	81252296055	551
			011111	81252296055	551
			011112	-	573

107.00043	81611100043	547	207.00194	81612100616	553
107.00049	81611500110	562	207.00194	81612100616	579
107.00049	81611505066	562	207.00194	81615100288	553
107.00049	81611506050	562	207.00194	81615100288	579
107.00050	81416850044	562	207.00194	81615100346	553
107.00068	81611100048	553	207.00194	81615100346	579
107.00068	81611100054	553	207.00195	81612100617	553
107.00068	81611100063	553	207.00195	81612100617	579
107.00069	81611505068	553	207.00195	81615100552	553
107.00069	81611506051	553	207.00195	81615100552	579
107.00070	81416850043	553	207.00195	81615100553	553
107.00070	81416850052	553	207.00195	81615100553	579
107.11100	81611106058	604	207.00195	81615100558	553
107.11100	81611106081	604	207.00195	81615100558	579
107.11100	81611106095	604	207.00196	81612100726	554
107.11102	81611456004	538	207.00196	81615100364	554
107.11102	81611456004	542	207.00197	81615100363	554
107.11102	81611456004	588	207.00198	81612100602	554
107.11102	81611456004	604	207.00198	81615100284	554
107.11103	81611456005	538	207.00199	81612100603	554
107.11103	81611456005	542	207.00199	81615100285	554
107.11103	81611456005	588	207.00200	81612100684	554
107.11103	81611456005	604	207.00200	81612100684	574
107.12100	81611100109	588	207.00200	81664100162	554
107.12100	81611106057	588	207.00200	81664100162	574
107.12100	81611106082	588	207.00200	81664100363	554
107.12100	81611106096	588	207.00200	81664100363	574
107.12101	81611500138	588	207.00200	81664100367	554
107.12101	81611500138	604	207.00200	81664100367	574
107.15001	81611100066	579	207.00201	81612100683	554
107.15001	81611106039	579	207.00201	81612100683	574
107.15001	81611106042	579	207.00201	81664100155	554
107.15001	81611106077	579	207.00201	81664100155	574
107.15001	81611106092	579	207.00201	81664100362	554
107.15001	81611106101	579	207.00201	81664100362	574
107.26100	81611106090	538	207.00201	81664100366	554
107.26100	81611106090	542	207.00201	81664100366	574
107.26100	81611106104	538	207.00202	81612100674	554
107.26100	81611106104	542	207.00202	81612100674	575
107.26102	81611500147	538	207.00202	81612100676	554
107.26102	81611500147	542	207.00202	81612100676	575
107.26102	81611500172	538	207.00202	81664100360	554
107.26102	81611500172	542	207.00202	81664100360	575
207.00185	81615100393	574	207.00202	81664100364	554
207.00185	81615100395	574	207.00202	81664100364	575
207.00186	81615100366	574	207.00203	81612100675	554
207.00186	81615100368	574	207.00203	81612100675	575
207.00187	81615100360	574	207.00203	81664100181	554
207.00187	81615100389	574	207.00203	81664100181	575
207.00187	81615100391	574	207.00203	81664100361	554
207.00189	81615100552	574	207.00203	81664100361	575
207.00189	81615100553	574	207.00203	81664100365	554
207.00190	81615100344	574	207.00203	81664100365	575
207.00191	81615100345	574	207.00408	81615100408	562
207.00191	81615100427	574	207.00409	81615100409	562
207.00191	81615100429	574	207.02000	85612100004	532
207.00192	81612100742	553	207.02001	85612100003	532
207.00192	81612100742	579	207.02002	85612100008	532
207.00193	81612100743	553	207.02003	85612100007	532
207.00193	81612100743	579	207.02004	85612300028	532
207.00193	81615100554	553	207.05080	81664100352	547
207.00193	81615100554	579	207.05081	81664100353	547
207.00193	81615100555	553	207.05161	81615105161	547
207.00193	81615100555	579	207.05162	81615105162	547



207.05163	81615105163	547	207.06085	81664100173	595
207.05164	81615105164	547	207.06085	81664100173	605
207.05363	81612105363	547	207.06086	81664106086	555
207.05364	81612105364	547	207.06086	81664106086	563
207.06072	81612100462	562	207.06086	81664106086	580
207.06072	81612100462	604	207.06086	81664106086	589
207.06076	81664100226	554	207.06086	81664106086	596
207.06076	81664100226	563	207.06086	81664106086	605
207.06076	81664100226	579	207.06087	81664106606	555
207.06076	81664100226	589	207.06087	81664106606	564
207.06076	81664100226	595	207.06087	81664106606	580
207.06076	81664100226	605	207.06087	81664106606	589
207.06076	81664106086	554	207.06087	81664106606	596
207.06076	81664106086	563	207.06087	81664106606	605
207.06076	81664106086	579	207.06088	81664106625	580
207.06076	81664106086	589	207.06088	81664106625	596
207.06076	81664106086	595	207.06088	81664106625	605
207.06076	81664106086	605	207.06089	81664106573	580
207.06077	81664106606	554	207.06089	81664106573	596
207.06077	81664106606	563	207.06089	81664106573	606
207.06077	81664106606	580	207.06090	81664106574	580
207.06077	81664106606	589	207.06090	81664106574	596
207.06077	81664106606	595	207.06090	81664106574	606
207.06077	81664106606	605	207.06091	81664100462	555
207.06077	81664400192	554	207.06091	81664100462	564
207.06077	81664400192	563	207.06091	81664100462	580
207.06077	81664400192	580	207.06091	81664100462	589
207.06077	81664400192	589	207.06091	81664100462	596
207.06077	81664400192	595	207.06091	81664100462	606
207.06077	81664400192	605	207.06092	81664100463	555
207.06078	81664100204	562	207.06092	81664100463	564
207.06078	81664100308	562	207.06092	81664100463	580
207.06078	81664100312	562	207.06092	81664100463	589
207.06079	81664100205	562	207.06092	81664100463	596
207.06079	81664100309	562	207.06092	81664100463	606
207.06079	81664100313	562	207.06093	81664106599	581
207.06080	81664100184	563	207.06093	81664106599	589
207.06080	81664100306	563	207.06093	81664106599	596
207.06080	81664100310	563	207.06093	81664106599	606
207.06081	81664100185	563	207.06094	81664400189	588
207.06081	81664100307	563	207.06094	81664400189	604
207.06081	81664100311	563	207.06095	81664100484	554
207.06082	81664100294	555	207.06095	81664100484	563
207.06082	81664100294	563	207.06095	81664100484	575
207.06082	81664100294	580	207.06096	81664106612	554
207.06082	81664100294	589	207.06096	81664106612	563
207.06082	81664100294	595	207.06096	81664106612	575
207.06082	81664100294	605	207.06096	81664106612	579
207.06083	81664100293	555	207.06096	81664106612	588
207.06083	81664100293	563	207.06096	81664106612	595
207.06083	81664100293	580	207.06096	81664106612	596
207.06083	81664100293	589	207.06097	81664106608	555
207.06083	81664100293	595	207.06097	81664106608	564
207.06083	81664100293	605	207.06097	81664106608	575
207.06084	81664100172	555	207.06097	81664106608	581
207.06084	81664100172	563	207.06097	81664106608	590
207.06084	81664100172	580	207.06097	81664106608	596
207.06084	81664100172	589	207.06097	81664106608	606
207.06084	81664100172	595	207.06098	81664400187	564
207.06084	81664100172	605	207.06099	81664106607	555
207.06085	81664100173	555	207.06099	81664106607	564
207.06085	81664100173	563	207.06099	81664106607	581
207.06085	81664100173	580	207.06099	81664106607	590
207.06085	81664100173	589	207.06099	81664106607	596

ALL ITEMS MENTIONED IN OUR CATALOGUE ARE NOT ORIGINAL PARTS BUT PERFECTLY INTERCHANGEABLE WITH THEM.

GOVERNING LEGISLATIONS FOR THE SALE OF OUR PRODUCTS DIFFER IN EACH COUNTRY.

INFRINGEMENTS, IF ANY, OF LOCAL LEGISLATIONS ARE RESPONSIBILITY OF THE RETAILER IN THE COUNTRY OF FINAL DISTRIBUTION.



207.06099	81664106607	606	307.00304	81615100936	575
207.06100	81664106607	555	307.00305	81615100587	575
207.06100	81664106607	564	307.00305	81615100771	575
207.06100	81664106607	581	307.00305	81615100883	575
207.06100	81664106607	590	307.00306	81615100474	575
207.06100	81664106607	597	307.00306	81615100476	575
207.06100	81664106607	606	307.00307	81615100475	575
207.06100	81664400192	555	307.00307	81615100477	575
207.06100	81664400192	564	307.00332	81615100468	564
207.06100	81664400192	581	307.00332	81615100468	581
207.06100	81664400192	590	307.00332	81615100468	590
207.06100	81664400192	597	307.00332	81615100468	597
207.06100	81664400192	606	307.00332	81615100468	606
307.00129	81615100129	545	307.00332	81615100536	564
307.00130	81615100130	545	307.00332	81615100536	581
307.00225	81615100225	548	307.00332	81615100536	590
307.00226	81615100226	548	307.00332	81615100536	597
307.00229	81615100229	548	307.00332	81615100536	606
307.00230	81615100230	548	307.00332	81615100822	564
307.00300	81615100474	556	307.00332	81615100822	581
307.00300	81615100474	590	307.00332	81615100822	590
307.00300	81615100476	556	307.00332	81615100822	597
307.00300	81615100476	590	307.00332	81615100822	606
307.00300	81615100848	556	307.00332	81615100823	564
307.00300	81615100848	590	307.00332	81615100823	581
307.00300	81615100856	556	307.00332	81615100823	590
307.00300	81615100856	590	307.00332	81615100823	597
307.00301	81615100475	556	307.00332	81615100823	606
307.00301	81615100475	590	307.00333	81615100311	565
307.00301	81615100477	556	307.00333	81615100311	598
307.00301	81615100477	590	307.00333	81615100311	607
307.00301	81615100847	556	307.00333	81615100333	565
307.00301	81615100847	590	307.00333	81615100333	598
307.00301	81615100855	556	307.00333	81615100333	607
307.00301	81615100855	590	307.00333	81615100801	565
307.00302	81615100470	556	307.00333	81615100801	598
307.00302	81615100470	581	307.00333	81615100801	607
307.00302	81615100470	590	307.00334	81615100800	564
307.00302	81615100472	556	307.00334	81615100800	597
307.00302	81615100472	581	307.00334	81615100800	606
307.00302	81615100472	590	307.00335	81615100799	565
307.00302	81615100760	556	307.00335	81615100799	597
307.00302	81615100760	581	307.00335	81615100799	607
307.00302	81615100760	590	307.00336	81615100804	565
307.00302	81615100763	556	307.00336	81615100804	597
307.00302	81615100763	581	307.00336	81615100804	607
307.00302	81615100763	590	307.00337	81615100803	565
307.00302	81615100872	556	307.00337	81615100803	597
307.00302	81615100872	581	307.00337	81615100803	607
307.00302	81615100872	590	307.00338	81615100752	565
307.00303	81615100471	556	307.00338	81615100752	598
307.00303	81615100471	581	307.00338	81615100752	607
307.00303	81615100471	590	307.00339	81615100751	565
307.00303	81615100473	556	307.00339	81615100751	598
307.00303	81615100473	581	307.00339	81615100751	607
307.00303	81615100473	590	307.00374	81615100312	565
307.00303	81615100759	556	307.00374	81615100312	598
307.00303	81615100759	581	307.00374	81615100312	607
307.00303	81615100759	590	307.00374	81615100374	565
307.00303	81615100871	556	307.00374	81615100374	598
307.00303	81615100871	581	307.00374	81615100374	607
307.00303	81615100871	590	307.00374	81615100802	565
307.00304	81615100770	575	307.00374	81615100802	598
307.00304	81615100882	575	307.00374	81615100802	607



307.00400	81615100280	565	307.15201	81615100735	581
307.00400	81615100280	597	307.15201	81615100735	590
307.00400	81615100280	607	307.15202	81615100348	556
307.00400	81615100400	565	307.15202	81615100348	581
307.00400	81615100400	597	307.15202	81615100348	590
307.00400	81615100400	607	307.15202	81615100644	556
307.00400	81615100704	565	307.15202	81615100644	581
307.00400	81615100704	597	307.15202	81615100644	590
307.00400	81615100704	607	307.15202	81615100738	556
307.00400	81615100824	565	307.15202	81615100738	581
307.00400	81615100824	597	307.15202	81615100738	590
307.00400	81615100824	607	307.15202	81615100980	556
307.00401	81615100331	565	307.15202	81615100980	581
307.00401	81615100331	597	307.15202	81615100980	590
307.00401	81615100331	607	307.15203	81615100381	556
307.00401	81615100401	565	307.15203	81615100381	581
307.00401	81615100401	597	307.15203	81615100381	590
307.00401	81615100401	607	307.15203	81615100643	556
307.00401	81615100405	565	307.15203	81615100643	581
307.00401	81615100405	597	307.15203	81615100643	590
307.00401	81615100405	607	307.15203	81615100737	556
307.00401	81615100915	565	307.15203	81615100737	581
307.00401	81615100915	597	307.15203	81615100737	590
307.00401	81615100915	607	307.15203	81615100979	556
307.00402	81615100332	565	307.15203	81615100979	581
307.00402	81615100332	597	307.15203	81615100979	590
307.00402	81615100332	607	307.25200	81615100274	533
307.00402	81615100402	565	307.25200	81615100820	533
307.00402	81615100402	597	307.25200	81615100942	533
307.00402	81615100402	607	307.25201	81615100275	533
307.00402	81615100406	565	307.25201	81615100821	533
307.00402	81615100406	597	307.25201	81615100941	533
307.00402	81615100406	607	307.25202	81615100276	533
307.00402	81615100916	565	307.25202	81615100812	533
307.00402	81615100916	597	307.25203	81615100277	533
307.00402	81615100916	607	307.25203	81615100813	533
307.00411	81615100331	565	307.25204	81615100562	533
307.00411	81615100331	597	307.25204	81615100564	533
307.00411	81615100331	607	307.25204	81615100810	533
307.00411	81615100401	565	307.25205	81615100563	533
307.00411	81615100401	597	307.25205	81615100565	533
307.00411	81615100401	607	307.25205	81615100811	533
307.00411	81615100405	565	307.25206	81612100382	533
307.00411	81615100405	597	307.25206	81612100482	533
307.00411	81615100405	607	307.25206	81612100704	533
307.00411	81615100705	565	307.25207	81612100383	533
307.00411	81615100705	597	307.25207	81612100483	533
307.00411	81615100705	607	307.25207	81612100699	533
307.00411	81615100827	565	307.25208	81612100368	533
307.00411	81615100827	597	307.25208	81612100486	533
307.00411	81615100827	607	307.25208	81612100698	533
307.15200	81615100380	556	307.25209	81612100369	533
307.15200	81615100380	581	307.25209	81612100487	533
307.15200	81615100380	590	307.25209	81612100697	533
307.15200	81615100736	556	307.25210	81612100474	534
307.15200	81615100736	581	307.25210	81612100692	534
307.15200	81615100736	590	307.25211	81612100475	534
307.15201	81615100323	556	307.25212	81612100478	534
307.15201	81615100323	581	307.25213	81612100479	534
307.15201	81615100323	590	307.25214	81615100570	534
307.15201	81615100351	556	307.25214	81615100862	534
307.15201	81615100351	581	307.25215	81615100573	534
307.15201	81615100351	590	307.25215	81615100861	534
307.15201	81615100735	556	407.00001	81416104067	545

ALL ITEMS MENTIONED IN OUR CATALOGUE ARE NOT ORIGINAL PARTS BUT PERFECTLY INTERCHANGEABLE WITH THEM.

GOVERNING LEGISLATIONS FOR THE SALE OF OUR PRODUCTS DIFFER IN EACH COUNTRY.

INFRINGEMENTS, IF ANY, OF LOCAL LEGISLATIONS ARE RESPONSIBILITY OF THE RETAILER IN THE COUNTRY OF FINAL DISTRIBUTION.



407.00002	81416104066	545	407.05454	81416105454	552
407.00003	81416104071	545	407.05455	81416105376	552
407.00004	81416104072	545	407.10185	81416100402	598
407.00150	81416100150	548	407.10187	81416100369	599
407.00151	81416100151	548	407.10188	81416100370	599
407.00152	81416100152	548	407.10189	81416100364	598
407.00191	81416100191	548	407.10190	81416100363	598
407.00225	81416100225	556	407.10191	81416140025	598
407.00226	81416100226	556	407.10192	81416140026	598
407.00227	81416100227	565	407.10193	81416142183	591
407.00228	81416100228	565	407.10193	81416142183	598
407.00300	81416850029	535	407.10193	81416142183	607
407.00300	81416850029	583	407.10194	81416142184	591
407.00301	81416100231	566	407.10194	81416142184	598
407.00301	81416100315	566	407.10194	81416142184	608
407.00302	81416100232	566	407.10195	81416505010	591
407.00302	81416100314	566	407.10195	81416505010	608
407.00303	81416100229	557	407.10196	81416850134	599
407.00303	81416100313	557	407.10196	81416850136	599
407.00304	81416100230	557	407.10197	81416850133	599
407.00304	81416100312	557	407.10197	81416850135	599
407.00305	81416100305	566	407.10198	81416144000	599
407.00306	81416100306	566	407.10199	81416146003	599
407.00307	81416100307	556	407.10200	81416146004	599
407.00308	81416100308	556	407.10201	81416850071	599
407.00309	81416105451	575	407.10201	81416850073	599
407.00309	81416105664	575	407.10202	81416850072	599
407.00309	81416105722	575	407.10202	81416850074	599
407.00310	81416105508	575	407.10203	81416850065	582
407.00310	81416105598	575	407.10203	81416850065	599
407.00310	81416105600	575	407.10203	81416850072	582
407.00311	81416105507	575	407.10203	81416850072	599
407.00311	81416105597	575	407.10203	81416850074	582
407.00311	81416105599	575	407.10203	81416850074	599
407.00312	81416100376	576	407.10203	81416850074	599
407.00313	81416100375	576	407.10204	81416850072	582
407.00314	81416850031	556	407.10204	81416850072	599
407.00314	81416850031	566	407.10204	81416850074	582
407.00315	81416850040	557	407.10204	81416850074	599
407.00315	81416850040	566	407.10204	81416850114	582
407.00316	81416102882	557	407.10204	81416850114	599
407.00316	81416102882	566	407.11088	81416106752	608
407.00317	81416102881	557	407.11089	81416106753	608
407.00317	81416102881	566	407.11090	81416106750	608
407.00318	81416102900	534	407.11091	81416106751	608
407.00319	81960020466	557	407.11092	81416106754	608
407.00319	81960020466	566	407.11093	81416106755	608
407.00319	81960020491	557	407.11094	81416140076	608
407.00319	81960020491	566	407.11095	81416106863	608
407.00319	81960020497	557	407.11096	81416146009	608
407.00319	81960020497	566	407.11097	81416100744	591
407.02090	85416104002	532	407.11097	81416100744	609
407.02091	85416104003	532	407.11098	81416100575	591
407.04066	81416130014	546	407.11098	81416100575	609
407.04066	81416130015	546	407.11099	81416100533	591
407.04067	81416130018	546	407.11099	81416100533	609
407.04067	81416130019	546	407.11100	81416100532	591
407.04068	81416130020	546	407.11100	81416100532	609
407.04068	81416130021	546	407.11101	81416100559	609
407.04118	81416100166	549	407.11102	81416100558	609
407.04119	81416100167	549	407.11103	81416140075	609
407.04120	81416100164	549	407.11104	81416140074	609
407.04121	81416104114	548	407.12080	81416106764	591
407.05453	81416105453	552	407.12081	81416106763	591
			407.12082	81416106766	591



407.12083	81416106765	591	407.26105	81416105741	539
407.12084	81416140077	591	407.26105	81416105746	539
407.12084	81416146008	591	407.26106	81416106806	539
407.12085	81416146006	592	407.26107	81416100562	539
407.12085	81416146010	592	407.26107	81416100562	543
407.12086	81416100560	592	407.26108	81416100563	539
407.12087	81416100561	592	407.26108	81416100563	543
407.12088	81416140078	592	407.26109	81429400304	539
407.12089	81416140079	592	407.26110	81416100463	540
407.12090	81416106769	592	407.26110	81416100463	543
407.15184	81416100397	582	407.26111	81416100464	540
407.15185	81416100399	582	407.26111	81416100464	543
407.15186	81416505013	557	407.27104	81416106685	543
407.15186	81416505013	567	407.27105	81416105742	543
407.15186	81416505013	576	407.27105	81416105747	543
407.15187	81416100367	583	407.27106	81416106807	543
407.15188	81416100368	583	407.27107	81416106657	543
407.15189	81416100362	582	407.30069	81416130081	549
407.15189	81416100409	582	407.30070	81416130080	549
407.15189	81416100569	582	407.30071	81416130071	548
407.15190	81416100361	582	407.30073	81416130073	548
407.15190	81416100408	582	407.30074	81416130078	549
407.15190	81416100568	582	407.30075	81416130079	549
407.15191	81416140023	582	501.89373	81637330069	549
407.15191	81416140027	582	504.99026	81637330067	549
407.15192	81416140024	582	504.99026	81637330075	549
407.15192	81416140028	582	507.00031	81637306430	567
407.15193	81416850095	582	507.00032	81637306432	567
407.15194	81416850094	582	507.00033	81637336033	567
407.15195	81416850099	582	507.00033	81637336049	567
407.15196	81416850098	582	507.00034	81637336057	567
407.15197	81416850129	583	507.00035	81637320059	567
407.15197	81416850131	583	507.00036	81637320060	567
407.15198	81416850130	583	507.00037	81637320061	567
407.15198	81416850132	583	507.00038	81637320062	567
407.15199	81416146001	583	507.00040	81637316556	567
407.15200	81416146000	583	507.00041	81637310261	567
407.25190	81416100224	534	507.00042	81637310260	567
407.25190	81416100353	534	507.07750	81637306305	549
407.25190	81416100359	534	507.07750	81637306316	549
407.25290	81416100223	534	507.07900	81637306307	549
407.25290	81416100352	534	507.10500	81637306531	599
407.25291	81416100333	534	507.10500	81637306531	609
407.25291	81416100343	534	507.10501	81637306529	599
407.25292	81416100334	534	507.10501	81637306529	609
407.25292	81416100342	534	507.10502	81637306561	599
407.25293	81416850059	534	507.10502	81637306561	609
407.26092	81416100414	538	507.10503	81637306560	599
407.26093	81416100415	538	507.10503	81637306560	609
407.26096	81416105680	538	507.15500	81637306534	583
407.26097	81416105681	538	507.15500	81637306534	592
407.26098	81416100472	539	507.15501	81637306533	583
407.26098	81416100472	542	507.15501	81637306533	592
407.26099	81416100471	539	507.15502	81637306550	583
407.26099	81416100471	542	507.15502	81637306550	592
407.26100	81416105712	539	507.15503	81637306549	583
407.26100	81416105712	542	507.15503	81637306549	592
407.26101	81416105711	539	507.15504	81637336071	583
407.26101	81416105711	542	507.15504	81637336071	592
407.2610281416105728 (81416105700)		539	507.15505	81637336073	583
407.2610281416105728 (81416105700)		543	507.15505	81637336073	592
407.2610381416105727 (81416105699)		539	507.15506	81637336072	583
407.2610381416105727 (81416105699)		543	507.15506	81637336072	592
407.26104	81416106684	539	507.15507	81637310356	584

ALL ITEMS MENTIONED IN OUR CATALOGUE ARE NOT ORIGINAL PARTS BUT PERFECTLY INTERCHANGEABLE WITH THEM.

GOVERNING LEGISLATIONS FOR THE SALE OF OUR PRODUCTS DIFFER IN EACH COUNTRY.

INFRINGEMENTS, IF ANY, OF LOCAL LEGISLATIONS ARE RESPONSIBILITY OF THE RETAILER IN THE COUNTRY OF FINAL DISTRIBUTION.



507.15507	81637310356	593	907.1118381611100123 (81611100091)	593	
507.15508	81637320074	584	907.1118381611100123 (81611100091)	609	
507.15508	81637320074	593	907.25100	81624100184	535
507.15509	81637320073	584	907.25100	81624100186	535
507.15509	81637320073	593	907.25101	81624100183	535
507.15510	81637320076	584	907.25101	81624100185	535
507.15510	81637320076	593	907.25102	81624100182	536
507.15511	81637320075	584	907.25102	81624100188	536
507.15511	81637320075	593	907.25103	81624100181	536
507.15512	81637306735	584	907.25103	81624100187	536
507.15513	81637306736	584	907.26170	81611100101	540
507.15514	81637306513	568	907.26170	81611100101	544
507.15515	81637306512	568	907.26171	81611100100	540
507.25500	81637336061	535	907.26171	81611100100	544
507.25500	81637336067	535	907.2617281611100124 (81611100099)	540	
507.25501	81637336062	535	907.2617281611100124 (81611100099)	544	
507.25501	81637336068	535	907.2617381611100125 (81611100098)	540	
507.25502	81637306449	535	907.2617381611100125 (81611100098)	544	
507.25502	81637306573	535	1001.14951	81664400192	560
507.25503	81637330116	535	1001.14951	81664400192	572
507.25504	81637306572	535	1001.14951	81664400192	602
507.25504	81637306572	557	1007.00001	81664100226	572
507.25504	81637306572	568	1007.00010	81418606090	568
507.25504	81637306656	535	1007.00011	81418600144	558
507.25504	81637306656	557	1007.00011	81418600144	569
507.25504	81637306656	568	1007.00011	81418600144	584
507.25504	81637306660	535	1007.00011	81418600144	600
507.25504	81637306660	557	1007.00058	81418600058	550
507.25504	81637306660	568	1007.00059	81416135035	550
507.30049	81637330049	550	1007.05187	81615105187	536
507.36006	81637336006	546	1007.05187	81615105187	558
707.10200	81637010048	568	1007.05187	81615105187	569
707.10200	81637010048	600	1007.05187	81615105187	600
707.10201	81637010057	568	1007.05187	81615105187	610
707.10201	81637010057	600	1007.05188	81615110001	536
707.10202	81637010044	568	1007.05188	81615110001	558
707.10202	81637010044	600	1007.05188	81615110001	569
707.15300	81637010047	557	1007.05188	81615110001	576
707.25100	81637010055	535	1007.05188	81615110001	600
707.25100	81637010058	535	1007.05188	81615110001	610
907.00048	81624100048	568	1007.05189	81615100273	569
907.00049	81624100049	568	1007.05189	81615100273	576
907.00050	81624100046	568	1007.05189	81615100273	601
907.00051	81624100047	568	1007.05189	81615100273	610
907.00063	81624100063	550	1007.05190	81615100271	558
907.00064	81624100064	550	1007.05190	81615100271	576
907.10180	81611100068	584	1007.05190	81615100271	584
907.10180	81611100068	600	1007.05190	81615100271	593
907.10181	81611100067	584	1007.05190	81615100490	558
907.10181	81611100067	600	1007.05190	81615100490	576
907.10182	81611106032	584	1007.05190	81615100490	584
907.10182	81611106032	600	1007.05190	81615100490	593
907.10182	81611106048	584	1007.10100	81664200234	558
907.10182	81611106048	600	1007.10100	81664200234	569
907.10183	81611106033	584	1007.10100	81664200234	576
907.10183	81611106033	600	1007.10101	81664200237	558
907.10183	81611106049	584	1007.10101	81664200237	569
907.10183	81611106049	600	1007.10101	81664200237	576
907.11180	81611100088	593	1007.10102	81664200125	558
907.11180	81611100088	609	1007.10102	81664200125	569
907.11181	81611100089	593	1007.10102	81664200125	576
907.11181	81611100089	609	1107.11000	81416106760	593
907.1118281611100122 (81611100090)	593		1107.11000	81416106760	610
907.1118281611100122 (81611100090)	609		1107.11001	81416106759	593



1107.11001	81416106759	610	1607.00705	81253206111	571
1407.00023	81626100023	569	1607.00706	81253206114	571
1407.00023	81626100023	601	1607.00707	81253206113	571
1407.00024	81626100024	569	1607.00708	81253206115	559
1407.00024	81626100024	601	1607.00708	81253206115	570
1407.00024	81626100040	569	1607.00708	81253206115	577
1407.00024	81626100040	601	1607.00708	81253206117	559
1407.15001	81626100021	558	1607.00708	81253206117	570
1407.15002	81626100020	558	1607.00708	81253206117	577
1500.00000	-	573	1607.00709	81253206116	559
1500.00000	-	587	1607.00709	81253206116	570
1500.00001	-	573	1607.00709	81253206116	577
1500.00001	-	587	1607.00709	81253206118	559
1504.10500	81252286028	551	1607.00709	81253206118	570
1504.10501	81252286027	551	1607.00709	81253206118	577
1507.10000	8125225-6545	537	1607.00710	81252606101	559
1507.10000	8125225-6545	540	1607.00710	81252606101	570
1507.10000	8125225-6545	544	1607.00710	81252606101	577
1507.10000	8125225-6545	561	1607.00711	81253206102	559
1507.10000	8125225-6545	573	1607.00711	81253206102	570
1507.10000	8125225-6545	603	1607.00711	81253206102	577
1507.10000	8125225-6545	611	1607.00712	81253206100	559
1507.10001	8125225-6544	537	1607.00712	81253206100	570
1507.10001	8125225-6544	540	1607.00712	81253206100	577
1507.10001	8125225-6544	544	1607.00713	81252606099	559
1507.10001	8125225-6544	561	1607.00713	81252606099	570
1507.10001	8125225-6544	573	1607.00713	81252606099	577
1507.10001	8125225-6544	603	1607.00713	81252606099	585
1507.10001	8125225-6544	611	1607.00714	81252606121	559
1507.10002	8125225-6547	537	1607.00714	81252606121	570
1507.10002	8125225-6547	541	1607.00714	81252606121	577
1507.10002	8125225-6547	544	1607.00714	81252606121	601
1507.10002	8125225-6547	561	1607.00715	81253206089	571
1507.10002	8125225-6547	573	1607.00716	81253206090	571
1507.10002	8125225-6547	603	1607.00717	-	570
1507.10002	8125225-6547	611	1607.10746	81251016658	585
1507.10100	8125229-6060	537	1607.10746	81251016658	601
1507.10100	8125229-6060	537	1607.10746	81251016682	585
1507.10100	8125229-6060	540	1607.10746	81251016682	601
1507.10100	8125229-6060	541	1607.10747	81251016657	585
1507.10100	8125229-6060	544	1607.10747	81251016657	601
1507.10100	8125229-6060	544	1607.10747	81251016681	585
1507.10100	8125229-6060	561	1607.10747	81251016681	601
1507.10100	8125229-6060	561	1607.10748	81251016504	585
1507.10100	8125229-6060	573	1607.10748	81251016504	601
1507.10100	8125229-6060	573	1607.10748	81251016664	585
1507.10100	8125229-6060	603	1607.10748	81251016664	601
1507.10100	8125229-6060	603	1607.10748	81251016688	585
1507.10100	8125229-6060	611	1607.10748	81251016688	601
1507.10100	8125229-6060	611	1607.10749	81251016503	585
1507.10101	8125229-6059	537	1607.10749	81251016503	601
1507.10101	8125229-6059	540	1607.10749	81251016663	585
1507.10101	8125229-6059	544	1607.10749	81251016663	601
1507.10101	8125229-6059	561	1607.10749	81251016687	585
1507.10101	8125229-6059	573	1607.10749	81251016687	601
1507.10101	8125229-6059	603	1607.10750	-	585
1507.10101	8125229-6059	611	1607.10750	-	601
1607.00700	81251016448	571	1607.10752	81251016522	585
1607.00701	81251016449	571	1607.10752	81251016522	601
1607.00702	81251016450	571	1607.10753	81251016521	585
1607.00703	81251016451	571	1607.10753	81251016521	601
1607.00704	81253206092	571	1607.10754	81251016498	585
1607.00704	81253206112	571	1607.10754	81251016498	601
1607.00705	81253206091	571	1607.10754	81251016660	585

ALL ITEMS MENTIONED IN OUR CATALOGUE ARE NOT ORIGINAL PARTS BUT PERFECTLY INTERCHANGEABLE WITH THEM.

GOVERNING LEGISLATIONS FOR THE SALE OF OUR PRODUCTS DIFFER IN EACH COUNTRY.

INFRINGEMENTS, IF ANY, OF LOCAL LEGISLATIONS ARE RESPONSIBILITY OF THE RETAILER IN THE COUNTRY OF FINAL DISTRIBUTION.



1607.10754	81251016660	601	1707.00606	81626906052	594
1607.10754	81251016684	585	1707.00606	81626906052	602
1607.10754	81251016684	601	1707.00606	81626906052	610
1607.10755	81251016499	585	1707.00607	81616906051	560
1607.10755	81251016499	601	1707.00607	81616906051	571
1607.10755	81251016659	585	1707.00607	81616906051	577
1607.10755	81251016659	601	1707.00607	81616906051	586
1607.10755	81251016683	585	1707.00607	81616906051	594
1607.10755	81251016683	601	1707.00607	81616906051	610
1707.00599	81971006079	550	1707.00607	81626906031	560
1707.00599	81971006098	550	1707.00607	81626906031	571
1707.00600	81626416080	559	1707.00607	81626906031	577
1707.00600	81626416080	571	1707.00607	81626906031	586
1707.00600	81626416080	585	1707.00607	81626906031	594
1707.00600	81626416080	593	1707.00607	81626906031	610
1707.00600	81626416080	610	1707.00607	81626906047	560
1707.00601	81626416081	559	1707.00607	81626906047	571
1707.00601	81626416081	571	1707.00607	81626906047	577
1707.00601	81626416081	585	1707.00607	81626906047	586
1707.00601	81626416081	593	1707.00607	81626906047	594
1707.00601	81626416081	610	1707.00607	81626906047	610
1707.00602	81626416068	560	1707.00607	81626906049	560
1707.00602	81626416068	571	1707.00607	81626906049	571
1707.00602	81626416068	585	1707.00607	81626906049	577
1707.00602	81626416068	594	1707.00607	81626906049	586
1707.00602	81626416068	610	1707.00607	81626906049	594
1707.00603	81626416067	560	1707.00607	81626906049	610
1707.00603	81626416067	571	1707.00608	81616906056	560
1707.00603	81626416067	585	1707.00608	81616906056	572
1707.00603	81626416067	594	1707.00608	81616906056	578
1707.00603	81626416067	610	1707.00608	81616906056	586
1707.00604	81626806142	540	1707.00608	81616906056	594
1707.00604	81626806142	544	1707.00608	81616906056	611
1707.00604	81626806142	594	1707.00608	81626906046	560
1707.00604	81626806142	610	1707.00608	81626906046	572
1707.00605	81626806143	540	1707.00608	81626906046	578
1707.00605	81626806143	544	1707.00608	81626906046	586
1707.00605	81626806143	594	1707.00608	81626906046	594
1707.00605	81626806143	610	1707.00608	81626906046	611
1707.00606	81626906030	560	1707.00608	81626906054	560
1707.00606	81626906030	571	1707.00608	81626906054	572
1707.00606	81626906030	577	1707.00608	81626906054	578
1707.00606	81626906030	586	1707.00608	81626906054	586
1707.00606	81626906030	594	1707.00608	81626906054	594
1707.00606	81626906030	602	1707.00608	81626906054	611
1707.00606	81626906030	610	1707.00608	81626906062	560
1707.00606	81626906048	560	1707.00608	81626906062	572
1707.00606	81626906048	571	1707.00608	81626906062	578
1707.00606	81626906048	577	1707.00608	81626906062	586
1707.00606	81626906048	586	1707.00608	81626906062	594
1707.00606	81626906048	594	1707.00608	81626906062	611
1707.00606	81626906048	602	1707.00608	81626906064	560
1707.00606	81626906048	610	1707.00608	81626906064	572
1707.00606	81626906050	560	1707.00608	81626906064	578
1707.00606	81626906050	571	1707.00608	81626906064	586
1707.00606	81626906050	577	1707.00608	81626906064	594
1707.00606	81626906050	586	1707.00608	81626906064	611
1707.00606	81626906050	594	1707.00609	81626906045	560
1707.00606	81626906050	602	1707.00609	81626906045	572
1707.00606	81626906050	610	1707.00609	81626906045	578
1707.00606	81626906052	560	1707.00609	81626906045	586
1707.00606	81626906052	571	1707.00609	81626906045	594
1707.00606	81626906052	577	1707.00609	81626906045	611
1707.00606	81626906052	586	1707.00609	81626906055	560



1707.00609	81626906055	572
1707.00609	81626906055	578
1707.00609	81626906055	586
1707.00609	81626906055	594
1707.00609	81626906055	611
1707.00609	81626906061	560
1707.00609	81626906061	572
1707.00609	81626906061	578
1707.00609	81626906061	586
1707.00609	81626906061	594
1707.00609	81626906061	611
1707.00609	81626906063	560
1707.00609	81626906063	572
1707.00609	81626906063	578
1707.00609	81626906063	586
1707.00609	81626906063	594
1707.00609	81626906063	611
1907.20000	81626406056	572
1907.20001	81626406055	572
1907.25000	81626456052	536
1907.25000	81626456052	560
1907.25000	81626456052	572
1907.25000	81626456052	578
1907.25001	81626456053	536
1907.25001	81626456053	560
1907.25001	81626456053	572
1907.25001	81626456053	578
2000.00016	-	573
2107.02080	81061026098	550
2107.02080	81061026099	550
2107.02080	81061026201	550
2107.02080	81061026202	550
2107.02080	81061026218	550
2107.02081	81061026110	550
2107.02081	81061026112	550
2107.02081	81061026205	550
2107.02081	81061026209	550
2107.02082	81473016048	550
2107.02082	81473016048	560
2107.02082	81473016048	572
2107.02082	81473016048	586
2107.02082	81473016048	602
2407.00100	81611400016	572
2407.00101	81970060002	560
2407.00101	81970060002	586
2407.00102	81970060036	560
2407.00102	81970060036	586
2407.00103	81970060003	561
2407.00103	81970060003	586
2407.11100	81970060027	602
2407.11101	81970060028	602
2407.12100	81970060029	586
2407.12101	81970060030	586
3007.00000	-	536
3007.00000	-	546
3007.00000	-	561
3007.00000	-	572
3007.00000	-	578
3007.00000	-	587
3007.00000	-	602
3007.00001	-	536

COS.RE

SIMILAR ref.	COS.PEL ref.	PAG			
-	003004	28	5001823641	201.32440	52
-	003120	9	5001823641	1001.23641	30
-	003120	14	5001823641	1001.23641	55
-	003120	15	5001832947	501.32947	26
-	003120	22	5001832948	501.32948	26
-	003120	49	5001833310	1006.33602	28
-	003120	64	5001833310	1006.33602	46
-	003121	22	5001834442	1101.50010	28
-	003121	31	5001834444	1101.50011	28
-	003122	31	5001834559	1601.50022	29
-	003123	49	5001834560	1601.50021	29
-	006121	31	5001834561	1601.50025	46
-	006122	31	5001834564	1601.50014	28
-	011112	31	5001834565	1601.50018	21
-	202.13202	58	5001834565	1601.50018	29
-	301.30011	39	5001834566	1601.50018	29
-	301.30012	39	5001834568	1601.50015	21
-	501.04016	11	5001834568	1601.50015	29
-	501.04017	11	5001838475	501.07923	53
-	501.04018	11	5001840475	1601.50020	29
-	501.04019	11	5001840476	1601.50019	29
-	801.10101	27	5001842202	501.07922	53
-	801.10104	27	5001842757	201.28254	24
-	1002.56557	55	5001842757	201.28254	51
-	1500.00000	49	5001842757	1001.00001	30
-	1500.00001	49	5001842757	1001.00001	55
-	1502.14000	65	5001847153	1501.03100	9
-	1701.53604	30	5001847153	1501.03100	14
-	1701.53605	30	5001847153	1501.03100	15
-	1901.30700	48	5001847153	1501.03100	22
-	1901.30701	48	5001847584	006130	31
-	2000.00016	35	5001847584	006131	31
-	3002.00002	22	5001847584	1504.10501	31
-	3002.00002	49	5001847586	006131	31
1209177	FO141602	14	5001847587	006120	31
20864256	1701.53611	47	5001847587	1504.10500	31
20864258	1701.53610	30	5001847589	1601.50013	28
20864258	1701.53610	47	5001850374	701.25600	26
26010-MB400	1601.05062	14	5001853757	1801.78000	54
26060-MB400	1601.05063	14	5001856184	201.14950	23
265500023R	007910	13	5001856184	201.14950	50
265500023L	007911	13	5001856184	201.14953	24
4421265	1501.03001	9	5001856184	201.14953	51
4421265	1501.03001	14	5001856184	1001.14951	30
4421265	1501.03001	15	5001856184	1001.14951	55
4421265	1501.03001	22	5001856195	201.28255	24
4421266	1501.03000	9	5001856195	201.28255	37
4421266	1501.03000	14	5001856290	501.56290	26
4421266	1501.03000	15	5001856292	501.53500	20
5000289377	501.89377	54	5001856292	501.53500	33
5000296594	011111	31	5001858126	1701.53615	48
5000296594	011111	31	5001858127	1701.53614	48
5000296594	011111	31	5001858129	1701.53601	21
5000296871	501.07913	53	5001858129	1701.53601	29
5000336341	501.36341	16	5001858129 + 50018348471701.53603		30
5000805326	501.05326	17	5001858130	1701.53600	21
5000938737	401.19008	53	5001858130	1701.53600	29
5001823641	201.32440	24	5001862030	003003	28
			5001867497	201.30544	37
			5001870556	1501.03000	9
			5001870556	1501.03000	14
			5001870556	1501.03000	15
			5001870556	1501.03000	22
			5001872437	1601.05060	14

5001872439	1601.05061	14	5010314953	201.28256	37
5001873673	501.07913	53	5010353003	301.30007	25
5010132441	201.32440	24	5010353003	301.30007	39
5010132441	201.32440	52	5010353004	301.30008	25
5010132441	201.32441	24	5010353004	301.30008	39
5010132441	201.32441	52	5010353104	401.53315	19
5010211001	801.11001	54	5010353105	401.53314	19
5010219006	401.19009	53	5010353170	1701.53612	47
5010219008	401.19006	53	5010353495	301.53001	18
5010220067	1701.53607	30	5010353496	301.53000	18
5010220068	1701.53606	30	5010353608	1701.60601	54
5010220413	1801.73000	30	5010353702	2401.50101	31
5010220975	1801.53000	22	5010353703	2401.25100	34
5010225061	101.01972	23	5010353843	701.53104	20
5010225068	301.00001	25	5010367075	301.25243	32
5010225392	301.25241	32	5010417132	1001.53099	21
5010225393	301.25240	32	5010417802	1001.53098	21
5010225404	301.30005	25	5010441111	1701.60600	54
5010225404	301.30005	39	5010445634	201.30543	37
5010225405	301.30006	25	5010445661	901.50001	27
5010225405	301.30006	39	5010445662	901.50000	27
5010225411	401.25090	32	5010468003	2401.25101	34
5010225459	1701.30600	47	5010468439	301.53003	18
5010225716	1701.53613	48	5010468440	301.53002	18
5010225722	301.00002	25	5010468441	1001.53105	21
5010225813	401.25813	25	5010468464	2401.53100	22
5010225815	401.25815	25	5010468537	401.53317	20
5010225817	401.25817	25	5010468538	401.53316	19
5010225819	401.25819	25	5010468582	101.23101	50
5010225821	401.25811	25	5010468593	401.19012	53
5010225822	401.25812	25	5010468635	301.30007	25
5010225908	1701.53609	47	5010468635	301.30007	39
5010225922	2401.50100	31	5010468636	301.30008	25
5010225930	1701.53608	47	5010468636	301.30008	39
5010228158	201.28252	24	5010468879	1701.30600	47
5010228253	201.28253	24	5010468880	1701.53616	22
5010228253	201.28253	51	5010468880	1701.53616	48
5010228253	201.28254	24	5010468940	1901.23600	55
5010228253	201.28254	51	5010468980	1601.50017	29
5010231669	1601.50027	29	5010468980	1601.53601	21
5010231670	1601.50026	29	5010468981	1601.50016	29
5010231849	1601.50023	29	5010468981	1601.53600	21
5010231850	1601.50024	29	5010491629	401.19008	53
5010271807	1601.23604	54	5010505041	1001.00015	27
5010301143	401.25820	26	5010544026	1001.53101	21
5010301144	401.25821	26	5010544026	1001.53101	27
5010301249	401.25091	33	5010544027	1001.53100	21
5010301971	101.01971	23	5010544027	1001.53100	27
5010301993	1901.30703	48	5010544029	1001.53103	28
5010301994	1901.30702	48	5010544029	1001.53103	34
5010304722	1001.30001	45	5010544030	1001.53102	28
5010304723	1001.30000	45	5010544030	1001.53102	34
5010306792	003001	28	5010544069	401.53311	19
5010312972	1601.23603	54	5010544070	401.53310	19
5010314693	1001.25101	33	5010544308	401.53308	19
5010314951	201.14950	23	5010544309	401.53309	19
5010314951	201.14950	50	5010544561	401.19012	53
5010314951	201.14951	23	5010544648	801.53021	27
5010314951	201.14951	50	5010544653	801.53021	27
5010314952	201.14952	23	5010544660	801.53020	27
5010314952	201.14952	50	5010544664	801.53020	27
5010314952	201.14953	24	5010544978	1601.23600	54
5010314952	201.14953	51	5010574309	401.19010	53
5010314953	201.28256	24	5010574311	401.19011	53



5010578237	901.30161	45	5010623231	501.31505	44
5010578238	901.30160	45	5010623232	501.31506	44
5010578243	901.30161	45	5010623246	501.31507	44
5010578244	901.30160	45	5010623247	501.31508	44
5010578246	101.30101	36	5010623483	2401.30101	34
5010578248	101.30100	36	5010623483	2401.30101	49
5010578255	701.30100	45	5010623600	401.30590	39
5010578335	401.30591	40	5010623600	401.30600	40
5010578335	401.30601	40	5010623600	401.30606	40
5010578335	401.30607	41	5010623600	401.30612	40
5010578336	401.30592	40	5010623600	401.30615	39
5010578336	401.30602	40	5010623600	401.30616	40
5010578336	401.30608	41	5010623619	1601.23600	54
5010578344	401.30599	41	5010623620	1601.23601	54
5010578346	401.30598	41	5010623868	401.53307	18
5010578348	401.30597	41	5010623868	401.53308	19
5010578350	401.30596	41	5010623869	401.53306	18
5010578352	401.30605	41	5010623869	401.53309	19
5010578354	401.30603	41	5010623889	401.53313	19
5010578355	401.30604	41	5010623890	401.53312	19
5010578376	301.30003	39	5010628893	401.25092	33
5010578378	301.30009	39	5010634248	1001.25103	34
5010578395	301.30005	25	5010640331	1001.25105	34
5010578395	301.30005	39	5010640332	1001.25104	34
5010578396	301.30006	25	5021012002	801.10002	26
5010578396	301.30006	39	62010BZ50A	401.04090	11
5010578401	201.30551	37	62010BZ51A	401.04091	11
5010578407	201.30552	37	620220006R	401.04090	11
5010578451	1601.30805	47	620220007R	401.04091	11
5010578452	1601.30801	47	623100256R	101.04002	10
5010578454	1601.30803	47	7420493931	1001.30006	45
5010578475	1601.30804	47	7420493933	1001.30005	45
5010578476	1601.30800	47	7420498623	202.71388	38
5010578478	1601.30802	47	7420498623	1002.56558	48
5010578503	501.30409	43	7420498623	1002.56558	55
5010578504	501.30410	43	7420583442	201.92545	37
5010578505	501.30413	43	7420583447	201.92546	37
5010578506	501.30414	43	7420583488	202.92544	38
5010578511	501.30418	43	7420583488	202.92544	52
5010578522	101.01972	23	7420721840	202.92547	36
5010578534	101.30101	36	7420726748	202.71389	38
5010578586	2401.30100	49	7420726748	202.71389	52
5010578630	101.25101	32	7420726748	202.71390	38
5010578659	901.25601	20	7420726748	202.71390	52
5010578659	901.25601	33	7420771757	202.92544	38
5010578660	901.25600	20	7420771757	202.92544	52
5010578660	901.25600	33	7420802348	1501.30001	49
5010578661	901.25601	20	7420802348	1501.30001	65
5010578661	901.25601	33	7420802350	1501.30000	49
5010578667	901.25600	20	7420802350	1501.30000	65
5010578667	901.25600	33	7420802353	1501.30002	49
5010578754	201.92548	36	7420802353	1501.30002	65
5010578812	401.30613	41	7420802418	1501.30100	49
5010578813	401.30614	41	7420802418	1501.30100	49
5010578876	301.30004	39	7420802418	1501.30100	65
5010578878	301.30010	39	7420802418	1501.30100	65
5010578888	101.53101	18	7420819613	1001.30000	45
5010588488	1001.53097	20	7420819616	1001.30001	45
5010610556	1001.25102	34	7420842848	1002.13010	46
5010610723	1001.00016	27	7420843793	101.30100	36
5010610723	1001.00016	45	7420849799	501.07924	53
5010623057	501.30411	43	7420849837	501.30420	20
5010623058	501.30412	43	7420849837	501.30420	33
5010623108	2401.53101	22	7420849837	501.30420	44

ALL ITEMS MENTIONED IN OUR CATALOGUE ARE NOT ORIGINAL PARTS BUT PERFECTLY INTERCHANGEABLE WITH THEM.

GOVERNING LEGISLATIONS FOR THE SALE OF OUR PRODUCTS DIFFER IN EACH COUNTRY.

INFRINGEMENTS, IF ANY, OF LOCAL LEGISLATIONS ARE RESPONSIBILITY OF THE RETAILER IN THE COUNTRY OF FINAL DISTRIBUTION.



7420850409	501.07925	53	7420973762	401.30589	39
7420862779	501.30405	42	7420973762	401.30593	40
7420862795	501.30399	42	7420973762	401.30595	40
7420862795	501.30400	42	7420973875	401.30598	41
7420862800	501.31500	44	7420973877	401.30599	41
7420862809	501.31501	44	7420980740	401.25091	33
7420862810	501.31503	44	7421015810	1701.60601	54
7420862813	501.31502	44	7421015813	1701.60600	54
7420862815	501.31504	44	7421087113	1001.00016	27
7420864256	1701.53611	47	7421087113	1001.00016	45
7420864258	1701.53610	30	7421090272	1002.13006	46
7420864258	1701.53610	47	7421090272	1002.13006	62
7420866665	501.30398	42	7421094387	202.13199	38
7420866665	501.30399	42	7421094387	202.13199	52
7420866665	501.30406	43	7421094387	202.13200	38
7420870164	301.25242	32	7421094387	202.13200	52
7420881197	1601.23603	54	7421094389	201.30545	51
7420903722	501.31511	45	7421094389	201.30547	51
7420903723	501.31509	44	7421094390	201.30546	37
7420903727	501.31512	45	7421094390	201.30546	51
7420903732	501.31510	44	7421094390	201.30546	58
7420903736	501.31499	44	7421094390	201.30548	37
7420903745	501.30395	42	7421094390	201.30548	51
7420903745	501.30397	42	7421094390	201.30548	58
7420903745	501.30401	42	7421094392	201.30550	37
7420903746	501.30394	42	7421094392	201.30550	51
7420903746	501.30396	42	7421094393	201.30549	37
7420903746	501.30402	42	7421094393	201.30549	51
7420903880	501.30399	42	7421094394	202.13201	38
7420903880	501.30405	42	7421094394	202.13201	52
7420903881	501.30398	42	7421094394	202.13201	58
7420903881	501.30417	43	7421094406	202.14202	36
7420903882	501.30397	42	7421094406	202.14202	50
7420903882	501.30403	42	7421094406	202.14202	58
7420903883	501.30396	42	7421094410	1001.30102	46
7420903883	501.30404	42	7421094410	1001.30102	62
7420903885	501.30395	42	7421094413	1002.13008	63
7420903885	501.30415	43	7421094415	1001.30101	45
7420903887	501.30394	42	7421094454	1001.30104	46
7420903887	501.30416	43	7421094454	1001.30104	62
7420904268	501.30395	42	7421094456	1001.30103	46
7420904268	501.30397	42	7421094456	1001.30103	62
7420904268	501.30407	43	7421094457	201.30545	51
7420904269	501.30394	42	7421094457	201.30546	37
7420904269	501.30396	42	7421094457	201.30546	51
7420904269	501.30408	43	7421094457	201.30546	58
7420928994	401.30590	39	7421094457	202.13199	38
7420928994	401.30600	40	7421094457	202.13199	52
7420928994	401.30606	40	7421094457	1002.13005	48
7420928994	401.30612	40	7421094457	1002.13005	55
7420928994	401.30615	39	7421103284	1601.50018	21
7420928994	401.30616	40	7421103284	1601.50018	29
7420936768	202.71389	38	7421213203	1002.13007	46
7420936768	202.71389	52	7421213203	1002.13007	62
7420936768	202.71390	38	7421275875	1901.23600	55
7420936768	202.71390	52	7421276373	501.32948	26
7420936772	202.71388	38	7421276373	501.53501	20
7420936772	202.71391	38	7421276373	501.53501	33
7420937430	701.53100	20	7421304658	301.00001	25
7420937446	701.25100	26	7421304660	301.00002	25
7420937446	701.25100	33	7421321475	401.29100	57
7420973757	401.30589	39	7421321542	401.29098	60
7420973757	401.30593	40	7421321562	401.29099	60
7420973757	401.30595	40	7421326526	501.31508	44



7421326527	501.31506	44	7482408451	501.29505	61
7421326550	501.30410	43	7482408482	501.29512	61
7421326551	501.30414	43	7482408487	501.29508	61
7421346867	501.07925	53	7482408488	501.29510	61
7421636295	1601.30805	47	7482408492	501.29500	60
7421636296	1601.30801	47	7482408493	501.29502	60
7421636309	1601.30804	47	7482491182	401.25092	33
7421636310	1601.30800	47	7482497193	1901.30703	48
7421636312	1601.30802	47	7482497194	1901.30702	48
7422078106	1001.29100	61	7482510540	1401.29505	63
7422189860	1901.30703	48	7482510542	1401.29504	63
7422189861	1901.30702	48	7482510548	1401.29501	63
7422800391	1502.14100	65	7482510549	1401.29500	63
7422800391	1502.14100	65	7482516626	1401.29507	63
7423005983	1701.29702	64	7482516638	1401.29506	63
7423005984	1701.29703	64	7482517786	1401.29503	63
7425982261	1502.14001	65	7482517788	1401.29502	63
7425982262	1502.14002	65	7482557005	201.29203	58
7482148692	301.29105	59	7482557008	201.29202	58
7482214695	301.29113	59	7482560239	1001.29105	62
7482219461	101.29100	56	7482567551	401.29092	60
7482220048	101.29107	57	7482567573	401.29091	60
7482221093	101.29105	57	7482567574	401.29090	60
7482223396	301.29112	59	7482574171	501.29515	61
7482226025	501.30420	20	7482574172	501.29514	61
7482226025	501.30420	33	7482574778	301.29107	58
7482226025	501.30420	44	7482574779	301.29106	58
7482230393	1701.29711	64	7482574835	301.29101	58
7482231340	301.29109	59	7482574837	301.29100	58
7482232463	1701.29710	64	7482575895	301.29108	59
7482250945	101.29106	57	7482577386	301.29111	59
7482252914	1601.29805	64	7482577387	301.29110	59
7482252916	1601.29804	64	7482582181	501.29506	61
7482265705	501.07924	53	7482582213	501.29507	61
7482275624	301.29104	59	7482584431	401.25090	32
7482275664	401.29107	57	7482585425	1101.29801	63
7482275772	1701.29701	64	7482585426	1101.29800	63
7482275869	101.29103	56	7482585431	1001.29103	62
7482275889	301.29103	59	7482585433	1001.29104	62
7482275921	1701.29700	64	7482587401	1001.29106	62
7482276014	101.29102	56	7482588678	1601.30805	47
7482282172	401.29097	60	7482588679	1601.30801	47
7482282179	401.29096	60	7482588681	1601.30803	47
7482282197	401.29093	60	7482588692	1601.30804	47
7482282217	401.29102	57	7482588693	1601.30800	47
7482282309	301.29102	59	7482589730	1701.29709	64
7482291434	1101.29802	63	7482589732	1701.29708	64
7482291437	1101.29803	63	7482590340	101.29101	56
7482295644	101.29104	57	7482622151	1601.29800	63
7482304801	401.29105	57	7482622235	1601.29801	63
7482304803	401.29106	57	7482622240	1601.29800	63
7482317468	1001.30001	45	7482622242	1601.29801	63
7482317469	1001.30000	45	7482622272	1601.29802	64
7482342590	401.29095	59	7482622276	1601.29803	64
7482342591	401.29094	59	7482677299	401.30590	39
7482366153	701.29700	61	7482677299	401.30600	40
7482376965	1001.29101	62	7482677299	401.30606	40
7482376967	1001.29102	62	7482690386	1701.53612	47
7482408426	501.29513	61	7482701283	401.29101	57
7482408433	501.29509	61	7482962977	1001.00011	27
7482408435	501.29511	61	7482962977	1001.00011	45
7482408447	501.29501	60	7484537795	101.29099	56
7482408449	501.29503	60	7484538758	003001	28
7482408450	501.29504	60	7484539338	1001.29106	62

ALL ITEMS MENTIONED IN OUR CATALOGUE ARE NOT ORIGINAL PARTS BUT PERFECTLY INTERCHANGEABLE WITH THEM.

GOVERNING LEGISLATIONS FOR THE SALE OF OUR PRODUCTS DIFFER IN EACH COUNTRY.

INFRINGEMENTS, IF ANY, OF LOCAL LEGISLATIONS ARE RESPONSIBILITY OF THE RETAILER IN THE COUNTRY OF FINAL DISTRIBUTION.



7484539407	3001.29000	64	8200002469	1601.04083	13
7484575384	401.29093	60	8200002470	1601.04082	13
7484838520	2401.30101	34	8200057679	801.04011	12
7484838520	2401.30101	49	8200057680	801.04012	12
7485113512	701.19100	54	8200074008	FO141602	14
7485118470	1501.03001	9	8200106346	1801.36000	7
7485118470	1501.03001	14	8200162710	1901.00500	7
7485118470	1501.03001	15	8200162710	1901.00500	15
7485118470	1501.03001	22	8200163516	1601.03801	9
7485120611	1601.04080	12	8200163518	1601.03800	9
7485120616	1601.04081	12	8200163914	1601.03803	8
7485120625	007910	13	8200163918	1601.03802	8
7485120626	007911	13	8200187234	101.03001	8
7485120736	401.04090	11	8200197134	401.03090	8
7485120738	401.04091	11	8200228394	003811	9
7485120742	101.04002	10	8200228395	003810	9
7485120747	201.04100	10	8200263356	1601.03805	9
7485120748	201.04101	10	8200263364	1601.03804	9
7485120759	101.04000	10	8200301026	1601.04083	13
7485120820	501.30398	42	8200301027	1601.04082	13
7485120820	501.30399	42	8200432027	201.00003	7
7485120820	501.30406	43	8200432028	201.00002	7
7485120974	501.04010	11	8200657209	101.04001	10
7485120975	501.04012	11	851200001R	401.04092	11
7485120981	501.04011	11	851210001R	401.04093	11
7485120982	501.04013	11	963016903R	501.04012	11
7485120988	501.04014	11	963021976R	501.04013	11
7485120990	501.04015	11			
7485122193	401.04089	10			
7485122295	801.04002	12			
7485122297	801.04002	12			
7485122298	801.04005	12			
7485122501	801.04007	12			
7485122504	801.04009	12			
7485122505	801.04006	12			
7485122506	801.04008	12			
7485122511	801.04010	12			
7485122727	801.04000	12			
7485122728	801.04001	12			
7485122751	801.04004	12			
7485122752	801.04003	12			
7485132205	2101.30080	34			
7485132205	2101.30080	48			
7485143226	101.04002	10			
7700351250	1801.36000	7			
7700353946	1601.00005	7			
7700353947	1601.00004	7			
7700376750	401.80700	15			
7701028236	501.28236	15			
7701044518	1601.00001	7			
7701044520	1601.00000	7			
7701044522	1601.00003	7			
7701044523	1601.00002	7			
7701470784	401.70784	7			
7750350504	201.00001	6			
7750350505	201.00000	6			
7751469067	101.69067	6			
7751474717	101.03000	8			
7751475533	201.03101	8			
7751475534	201.03100	8			
7751688433	101.88433	6			
7751688434	101.88434	6			
7751688435	101.88435	6			
7751690121	101.90121	6			

COS.VO

SIMILAR ref.	COS.PEL ref.	PAG
-	003002	110
-	003120	73
-	003120	86
-	003120	123
-	003120	136
-	003121	73
-	003122	113
-	003123	113
-	006007	113
-	011117	113
-	202.13206	103
-	202.13206	117
-	502.62804	107
-	502.62805	107
-	802.99017	96
-	802.99018	96
-	902.14077	131
-	902.99000	96
-	902.99001	96
-	1002.02004	107
-	1002.13009	120
-	1002.99013	97
-	1002.99014	97
-	1102.14610	133
-	1500.00000	114
-	1500.00001	114
-	1602.61662	110
-	1602.61671	110
-	1702.65598	111
-	1702.65599	111
-	3002.00001	78
-	3002.00001	81



-	3002.00001	99	1621448	1002.21149	90
-	3002.00001	113	1621449	1002.21148	90
-	3002.00001	123	1621450	1002.21451	90
-	3002.00002	69	1621451	1002.21450	90
-	3002.00002	73	1621905	1002.21905	90
1062133	302.64301	78	1621907	1002.21906	90
1062134	302.64300	78	1623147	1702.14607	111
1062163	1102.64501	78	1623147	1702.14607	122
1062190	1602.81665	98	1623147	1702.14607	135
1062547	1102.62547	97	1623248	1702.14606	111
1062548	1102.62548	97	1623248	1702.14606	122
1062565	1702.65601	80	1623248	1702.14606	135
1062565	1702.65601	98	1623459	202.23459	93
1062565	1702.65601	111	1623726	1602.61660	110
1062566	1702.65600	80	1623727	1602.61661	110
1062566	1702.65600	98	1623888	202.16121	89
1062566	1702.65600	111	1626679	402.89327	78
1062636	1702.14608	111	1626679	402.89327	95
1062636	1702.14608	123	1626680	402.89328	78
1062636	1702.14608	135	1626680	402.89328	95
1062637	1702.14605	111	1674918	2102.64080	81
1062637	1702.14605	122	1674918	2102.64080	99
1062637	1702.14605	135	1674918	2102.64080	112
1063327	1702.65605	99	1676400	2102.13080	80
1063327	1702.65605	112	1676400	2102.13080	99
1063328	1702.65606	99	1676400	2102.13080	112
1063328	1702.65606	112	1676576	2102.13080	80
1063509	102.44482	77	1676576	2102.13080	99
1063509	102.44482	93	1676576	2102.13080	112
1077451	1002.77451	96	1697007	502.33333	89
1079965	202.71389	94	1698144	902.98145	90
1079965	202.71389	103	1698145	902.98144	90
1079965	202.71390	95	1698146	1102.98147	91
1079965	202.71390	104	1698147	1102.98146	91
1079981	202.71381	103	1699011	502.99011	90
1079981	202.71387	103	1699013	502.99013	90
1079981	202.71389	94	1699014	502.44444	89
1079981	202.71389	103	1699017	502.99017	90
1079981	1002.56557	99	20207881	501.31505	69
1079981	1002.56557	112	20207881	501.31505	71
1079997	202.13207	103	20360266	102.60266	102
1079997	202.13207	117	20360273	1602.60273	98
1080061	1002.80061	91	20360274	1602.60274	98
1086533	1402.86533	98	20360507	102.44455	93
1086534	1402.86534	98	20360788	1002.60789	108
1088870	1102.88871	91	20360789	1002.60788	108
1088871	1102.88870	91	20360806	502.62798	106
1089122	1002.89123	91	20360807	502.62799	106
1509844	1002.09844	88	20360810	502.62801	106
1509846	1002.09846	88	20360811	502.62799	106
1573830	402.73830	88	20360811	502.62800	106
1584316	702.00012	90	20360898	1602.61667	111
1593923	1602.93923	91	20360899	1602.61668	111
1593924	1602.93924	91	20372037	1702.14607	111
1610782	1202.10783	91	20372037	1702.14607	122
1610783	1202.10782	91	20372037	1702.14607	135
1619106	2402.44100	136	20372038	1702.14606	111
1619148	1202.89093	98	20372038	1702.14606	122
1619149	1202.89092	98	20372038	1702.14606	135
1619690	1402.86533	98	20372039	1702.14605	111
1619691	1402.86534	98	20372039	1702.14605	122
1621181	102.12163	89	20372039	1702.14605	135
1621182	1102.21183	91	20372064	202.75931	102
1621183	1102.21182	91	20372064	202.75931	116

ALL ITEMS MENTIONED IN OUR CATALOGUE ARE NOT ORIGINAL PARTS BUT PERFECTLY INTERCHANGEABLE WITH THEM.

GOVERNING LEGISLATIONS FOR THE SALE OF OUR PRODUCTS DIFFER IN EACH COUNTRY.

INFRINGEMENTS, IF ANY, OF LOCAL LEGISLATIONS ARE RESPONSIBILITY OF THE RETAILER IN THE COUNTRY OF FINAL DISTRIBUTION.



20372065	202.75932	102	20425626	402.74999	104
20372065	202.75932	116	20425626	402.74999	118
20372226	402.89327	78	20425627	402.74998	104
20372226	402.89327	95	20425627	402.74998	118
20372227	402.89328	78	20425732	010080	81
20372227	402.89328	95	20425732	010080	81
20379171	1202.65181	80	20425732	010080	113
20379172	1202.65180	80	20425732	010080	114
20379175	1202.79175	109	20429679	402.75003	105
20379175	1202.79175	121	20429680	402.75005	105
20379176	1202.79176	109	20429681	402.75004	105
20379176	1202.79176	121	20433678	402.75011	105
20379348	2402.53100	81	20433678	402.75011	118
20379348	2402.53100	113	20452847	1102.62551	108
20379348	2402.53100	123	20452848	1102.62552	108
20379357	102.53719	101	20452886	1102.62549	108
20379358	102.53720	101	20452887	1102.62550	108
20379428	1602.61665	111	20453627	1102.62557	109
20379429	1602.61666	111	20453628	1102.62558	109
20379437	1002.91313	97	20453676	402.75011	105
20379438	1002.91314	97	20453676	402.75011	118
20379439	1002.91315	97	20453677	402.75012	105
20379439	1002.91315	108	20453677	402.75012	118
20382890	1002.56562	108	20453679	402.75012	105
20383038	1002.56561	108	20453679	402.75012	118
20383543	1702.65603	112	20453690	102.53960	101
20391583	902.85000	107	20453690	102.53960	116
20392544	202.92544	95	20453716	102.53716	101
20392544	202.92544	104	20453900	202.75935	102
20398135	1702.14607	111	20453900	202.75935	116
20398135	1702.14607	122	20453930	1102.62555	109
20398135	1702.14607	135	20453931	1102.62556	109
20398136	1702.14606	111	20453960	102.53960	101
20398136	1702.14606	122	20453960	102.53960	116
20398136	1702.14606	135	20455981	502.62803	106
20398385	1102.62547	97	20455982	502.62802	106
20398386	1102.62548	97	20455984	502.62803	106
20398387	1102.64501	78	20455986	502.55986	106
20398388	1102.64500	78	20455995	502.55995	106
20398389	1102.64501	78	20455995	502.62799	106
20398390	1102.64500	78	20456550	402.75010	105
20398466	1702.65601	80	20456709	702.01220	107
20398466	1702.65601	98	20456804	402.75007	80
20398466	1702.65601	111	20456804	402.75007	105
20398467	1702.65600	80	20456805	402.75009	80
20398467	1702.65600	98	20456805	402.75009	105
20398467	1702.65600	111	20456806	402.75008	80
20398660	003000	109	20456806	402.75008	105
20398707	402.75005	105	20456963	102.53717	101
20398708	402.75004	105	20466895	1002.56560	107
20398709	402.75003	105	20467037	1402.67037	109
20398824	1602.61659	110	20467038	1402.67038	109
20398907	1402.86533	98	20467387	1102.62559	109
20398908	1402.86534	98	20467388	1102.62560	109
20409818	102.53718	101	20467442	402.75010	105
20409874	1602.61669	110	20467448	402.75006	105
20409875	1602.61670	110	20498620	1002.56559	107
20425418	1102.62553	109	20498623	1002.56558	113
20425419	1102.62554	109	20507020	1102.62555	109
20425469	202.65201	77	20507021	1102.62556	109
20425469	202.65201	79	20507252	1002.91005	97
20425484	1602.61658	110	20507252	1002.91005	108
20425625	402.74997	104	20507623	006011	81
20425625	402.74997	118	20507623	006011	114



20507624	006012	81	20583434	1002.56559	107
20507624	006012	114	20583440	1002.56564	108
20516776	102.53716	101	20588325	1702.65607	80
20527443	702.01219	107	20588325	1702.65607	112
20529478	202.65201	77	20588326	1702.65608	80
20529478	202.65201	79	20588326	1702.65608	112
20529483	202.65200	77	20593721	301.30003	70
20529483	202.65200	79	20593731	302.30006	70
20529638	302.41007	104	20593734	302.30004	70
20529638	302.41007	118	20593735	301.30004	70
20529640	302.41008	104	20703983	501.31506	69
20529640	302.41008	118	20703983	501.31506	71
20529668	102.53719	101	20707874	501.31507	71
20529672	102.53720	101	20707881	501.31505	69
20529682	202.75933	102	20707881	501.31505	71
20529684	202.75934	102	20708303	501.31508	71
20529685	202.75937	103	20710524	1602.61665	111
20529686	202.75936	103	20710525	1602.61666	111
20529704	102.53718	101	20711859	402.75003	105
20529705	102.75545	102	20711860	402.75005	105
20529706	102.75546	102	20711861	402.75004	105
20529707	102.75547	102	20713720	1602.61667	111
20529708	102.75548	102	20713721	1602.61668	111
20529740	402.75000	79	20716739	502.13602	118
20529740	402.75000	104	20716956	502.13606	106
20529740	402.75000	118	20716956	502.13606	119
20529741	402.75001	79	20721840	202.92547	94
20529741	402.75001	104	20722652	202.71389	94
20529741	402.75001	118	20722652	202.71389	103
20529742	402.75002	79	20722652	202.71390	95
20529742	402.75002	104	20722652	202.71390	104
20529742	402.75002	118	20723630	202.71380	103
20529765	202.65202	77	20723630	202.71381	103
20529765	202.65202	79	20734485	003001	109
20530146	1702.65602	112	20745227	1601.50015	72
20533138	102.53717	101	20746401	502.62801	106
20534600	1102.62557	109	20762992	1602.61667	111
20534601	1102.62558	109	20762993	1602.61668	111
20537185	202.65201	77	20763003	1602.61664	111
20537185	202.65201	79	20763004	1602.61663	111
20537280	1501.03100	73	20769783	1501.03001	73
20538003	301.53000	68	20769784	1501.03000	73
20538003	301.53000	74	20779458	1602.12702	72
20538006	301.53001	68	20789440	003000	109
20538006	301.53001	74	20818763	1602.12701	69
20538011	1001.53100	69	20818771	1602.12700	69
20538011	1001.53100	72	20826211	1602.61669	110
20538011	1001.53100	75	20826213	1602.61670	110
20538012	1001.53101	69	20826227	1102.62553	109
20538012	1001.53101	72	20826231	1102.62554	109
20538012	1001.53101	75	20827042	1102.62557	109
20538247	1001.53103	72	20827044	1102.62558	109
20538248	1001.53102	72	20842848	1002.13010	120
20545094	1002.13001	119	20843850	202.13205	103
20545095	1002.13000	119	20843850	202.13205	117
20549696	202.71380	103	20847082	702.01218	107
20549696	202.71381	103	20854568	502.91757	96
20565103	006013	114	20861573	1602.61663	111
20565104	006014	114	20861574	1602.61664	111
20565107	010081	114	20861576	1602.61668	111
20567637	502.62803	106	20861583	1602.61667	111
20567647	502.62802	106	20861584	1602.61668	111
20567670	502.55986	106	20862575	1602.61667	111
20567685	502.55995	106	20862779	501.30405	68

ALL ITEMS MENTIONED IN OUR CATALOGUE ARE NOT ORIGINAL PARTS BUT PERFECTLY INTERCHANGEABLE WITH THEM.

GOVERNING LEGISLATIONS FOR THE SALE OF OUR PRODUCTS DIFFER IN EACH COUNTRY.

INFRINGEMENTS, IF ANY, OF LOCAL LEGISLATIONS ARE RESPONSIBILITY OF THE RETAILER IN THE COUNTRY OF FINAL DISTRIBUTION.



20862779	501.30405	71	21090272	1002.13006	119
20862782	501.30406	71	21094384	202.13203	85
20862795	501.30400	68	21094384	202.13203	117
20862795	501.30400	71	21094384	202.13203	128
20862800	501.31500	68	21094387	202.13199	84
20862800	501.31500	71	21094387	202.13199	116
20862809	501.31501	71	21094387	202.13199	127
20862810	501.31504	69	21094387	202.13200	84
20862810	501.31504	71	21094387	202.13200	117
20862813	501.31502	71	21094387	202.13200	128
20862815	501.31503	69	21094388	202.13203	85
20862815	501.31503	71	21094388	202.13203	117
20892384	006012	81	21094388	202.13203	128
20892384	006012	114	21094388	202.13204	85
20892386	006011	81	21094388	202.13204	117
20892386	006011	114	21094388	202.13204	128
20900679	502.13604	105	21094389	201.30545	84
20900679	502.13604	118	21094389	201.30545	127
20900682	502.13605	106	21094389	201.30547	84
20900682	502.13605	119	21094389	201.30547	127
20903722	501.31505	69	21094391	202.13202	84
20903722	501.31505	71	21094391	202.13202	117
20903722	501.31511	72	21094391	202.13202	128
20903723	501.31510	72	21094392	201.30550	84
20903727	501.31512	72	21094392	201.30550	127
20903732	501.31509	72	21094393	201.30549	84
20910229	010080	81	21094393	201.30549	127
20910229	010080	81	21094394	202.13201	84
20910229	010080	113	21094394	202.13201	117
20910229	010080	114	21094394	202.13201	128
20917957	1102.62557	109	21094397	202.13202	84
20917958	1102.62558	109	21094397	202.13202	117
20936169	502.62803	106	21094397	202.13202	128
20936170	502.62802	106	21094406	202.14202	126
20936759	202.71389	94	21094413	1002.13008	119
20936759	202.71389	103	21094457	201.30545	84
20936759	202.71390	95	21094457	201.30545	127
20936759	202.71390	104	21094457	202.13199	84
20936769	202.71387	103	21094457	202.13199	116
20936769	202.71391	104	21094457	202.13199	127
20937431	701.53104	72	21094457	202.13204	85
20937431	701.53104	75	21094457	202.13204	117
20961733	402.12090	68	21094457	202.13204	128
21001645	1602.61663	111	21094457	1002.13005	86
21001649	1602.61664	111	21094457	1002.13005	123
21001663	1602.61667	111	21094457	1002.13005	135
21001668	1602.61668	111	21097448	006012	81
21023794	102.75545	102	21097448	006012	114
21023797	102.75546	102	21097449	006011	81
21023802	102.75548	102	21097449	006011	114
21035637	1602.13800	122	21097450	006008	81
21035638	1602.13801	122	21097450	006008	113
21035644	1602.13808	122	21103284	1601.50018	72
21035645	1602.13807	122	21123489	1602.13798	122
21035690	1602.13802	122	21123523	1602.13799	122
21035692	1602.13803	122	21151129	502.13604	105
21063887	006013	114	21151129	502.13604	118
21063895	006014	114	21151132	502.13605	106
21068469	1002.13011	120	21151132	502.13605	119
21068473	1002.13012	120	21190825	102.13100	115
21078543	1102.13509	121	21203311	502.91757	96
21078545	1102.13508	121	21213202	1002.13007	119
21087346	1602.13812	121	21213203	1002.13007	119
21087347	1602.13813	122	21221129	1602.14800	86



21221129	1602.14800	134	21413732	202.14203	126
21221130	1602.14801	86	21413734	1102.14607	133
21221130	1602.14801	134	21413763	202.14200	126
21221133	1602.14808	86	21413774	1102.14606	133
21221133	1602.14808	134	21413786	402.14088	129
21221134	1602.14807	86	21413786	402.14092	85
21221134	1602.14807	134	21413786	402.14092	129
21221142	1602.14805	134	21413787	402.14090	85
21221145	1602.14804	134	21413787	402.14090	129
21221151	1602.14824	135	21413789	402.14089	129
21221152	1602.14823	135	21413789	402.14091	85
21221153	1602.14816	134	21413789	402.14091	129
21221154	1602.14815	134	21425186	102.53960	101
21221155	1602.14818	134	21425186	102.53960	116
21221156	1602.14817	134	21430598	1102.62553	109
21221157	1602.14819	135	21430599	402.75007	80
21221158	1602.14820	135	21430599	402.75007	105
21221159	1602.14822	135	21430600	402.75009	80
21221160	1602.14821	135	21430600	402.75009	105
21261274	1702.65607	80	21430672	402.75008	80
21261274	1702.65607	112	21430672	402.75008	105
21261275	1702.65608	80	21443604	702.14901	131
21261275	1702.65608	112	21448885	1102.13507	121
21297258	1002.13013	120	21451000	1102.13505	121
21297261	1002.13014	120	21451002	1102.13504	121
21297909	1602.13802	122	21469918	1102.62549	108
21297911	1602.13803	122	21469924	1102.62550	108
21297917	1602.13810	122	21469979	1102.62554	109
21297918	1602.13809	122	21475603	501.31508	71
21299955	1402.67037	109	21478751	1102.13506	121
21300059	1402.67038	109	21478755	1102.13502	120
21302470	202.75930	102	21478759	1102.13503	120
21302470	202.75930	116	21484901	402.75010	105
21316575	402.14085	85	21495266	402.14097	130
21316575	402.14085	129	21495267	402.14096	130
21316576	402.14084	85	21495268	402.14098	130
21316576	402.14084	129	21505893	1702.65607	80
21316577	402.14086	85	21505893	1702.65607	112
21316577	402.14086	129	21505894	1702.65608	80
21323106	1602.13800	122	21505894	1702.65608	112
21323108	1602.13801	122	21520015	302.66101	85
21323113	1602.13808	122	21520119	302.66100	85
21323114	1602.13807	122	21608661	1602.14802	134
21326526	501.31508	71	21608663	1602.14803	134
21326527	501.31506	69	21608666	1602.14814	134
21326527	501.31506	71	21608667	1602.14813	134
21344647	302.14101	128	21642377	1402.14501	133
21344649	302.14100	128	21642399	1402.14500	133
21346521	1602.14811	134	21735299	1502.14004	76
21346522	1602.14812	134	21735299	1502.14004	87
21350581	1702.13700	69	21735299	1502.14004	136
21350581	1702.13700	73	21735301	1502.14003	76
21358670	102.53716	101	21735301	1502.14003	87
21359080	402.74997	104	21735301	1502.14003	136
21359080	402.74997	118	21765994	502.14507	131
21359082	402.74999	104	21766009	502.14508	131
21359082	402.74999	118	21828914	402.75003	105
21359090	402.74998	104	21829051	402.75005	105
21359090	402.74998	118	21829052	402.75004	105
21359257	1102.62555	109	21838427	402.14099	130
21359260	1102.62556	109	21838939	402.14100	130
21392183	302.14101	128	21838944 FONDO	402.14101	130
21392187	302.14100	128	21838945 FONDO	402.14100	130
21412897	1002.13010	120	21849884	902.31601	75

ALL ITEMS MENTIONED IN OUR CATALOGUE ARE NOT ORIGINAL PARTS BUT PERFECTLY INTERCHANGEABLE WITH THEM.

GOVERNING LEGISLATIONS FOR THE SALE OF OUR PRODUCTS DIFFER IN EACH COUNTRY.

INFRINGEMENTS, IF ANY, OF LOCAL LEGISLATIONS ARE RESPONSIBILITY OF THE RETAILER IN THE COUNTRY OF FINAL DISTRIBUTION.



21849885	902.31600	75	3175247	202.75246	94
21849897	902.31603	75	3175366	1702.65604	112
21849909	902.31602	75	3175367	1702.65602	112
21849913	102.31100	74	3175376	102.65100	79
21868931	402.14101	130	3175406	302.41007	104
21874450	1102.14601	133	3175406	302.41007	118
21874457	1102.14600	133	3175407	302.41008	104
21924923	1002.13010	120	3175407	302.41008	118
21940892	202.14201	126	3175417	402.75000	79
21963005	1102.66601	86	3175417	402.75000	104
21963141	1102.66600	86	3175417	402.75000	118
22078082	1002.14020	132	3175418	402.75001	79
22105756	1602.81665	98	3175418	402.75001	104
22239217	1602.14800	86	3175418	402.75001	118
22239217	1602.14800	134	3175419	402.75002	79
22239219	1602.14801	86	3175419	402.75002	104
22239219	1602.14801	134	3175419	402.75002	118
22239220	1602.14808	86	3175545	102.75545	102
22239220	1602.14808	134	3175546	102.75546	102
22239221	1602.14807	86	3175547	102.75547	102
22239221	1602.14807	134	3175548	102.75548	102
22239225	1602.14802	134	3175918	1702.65601	80
22239226	1602.14803	134	3175918	1702.65601	98
22239232	1602.14814	134	3175918	1702.65601	111
22239234	1602.14813	134	3175919	1702.65600	80
22239248	1602.14804	134	3175919	1702.65600	98
22239254	1602.14805	134	3175919	1702.65600	111
22247766 FONDO	402.14099	130	3175927	202.75927	102
22249883	402.14084	85	3175927	202.75927	116
22249883	402.14084	129	3175928	202.75928	102
22332592	1602.14824	135	3175928	202.75928	116
22332593	1602.14823	135	3175929	202.75929	102
22332594	1602.14816	134	3175929	202.75929	116
22332595	1602.14815	134	3175930	202.75930	102
22332596	1602.14818	134	3175930	202.75930	116
22332597	1602.14817	134	3175933	202.75933	102
22332598	1602.14819	135	3175934	202.75934	102
22332600	1602.14820	135	3176541	1902.65203	99
22332603	1602.14822	135	3176541	1902.65203	112
22332604	1602.14821	135	3176541	1902.65203	123
22376336	402.31090	74	3176542	1902.65202	99
24426873	1701.53601	73	3176542	1902.65202	112
24426875	1701.53600	73	3176542	1902.65202	123
25369341	401.30605	70	3176545	1902.65201	80
25369342	401.30603	70	3176545	1902.65201	99
25369343	401.30604	70	3176546	1902.65200	80
3090971	1102.62548	97	3176546	1902.65200	99
3090972	1102.62547	97	3980869	1102.62547	97
3091256	502.00001	95	3980870	1102.62548	97
3091259	502.00000	95	3981043	202.65202	77
3091757	502.91757	96	3981043	202.65202	79
3092854	502.91756	96	3981256	402.88888	78
3127594	1002.91005	97	3981256	402.88888	95
3127594	1002.91005	108	3981455	006010	100
3171391	202.71389	94	3981456	006000	100
3171391	202.71389	103	3981594	1602.81669	98
3171391	202.71390	95	3981666	1602.81666	98
3171391	202.71390	104	3981668	1602.81668	98
3175032	1602.93922	92	3981762	202.75247	94
3175158	202.65201	77	3981764	202.75246	94
3175158	202.65201	79	3981782	011211	100
3175159	202.65200	77	3981920	2402.53101	113
3175159	202.65200	79	3981923	1902.65201	80
3175246	202.75247	94	3981923	1902.65201	99



3981924	1902.65200	80	8191421	102.64100	77
3981924	1902.65200	99	81915870	1102.64500	78
3987252	1002.56559	107	8191593	302.64301	78
8122893	202.41237	93	8191594	302.64300	78
8122894	202.41236	93	8191747	005890	92
8140333	1002.40333	96	8191748	005880	92
8141003	302.41003	95	82052484	1102.13505	121
8141004	302.41004	95	82053690	1102.13501	120
8141236	202.41237	93	82056727	102.13100	115
8141237	202.41236	93	82056840	102.13102	115
8141289	1102.41289	78	82056986	1102.13500	120
8141289	1102.41289	97	82056991	1102.13504	121
8141290	1102.41290	78	82060441	1002.13003	119
8141290	1102.41290	97	82060445	1002.13004	119
8141312	302.41005	95	82062209	102.13105	115
8141313	302.41004	95	82063513	102.13107	116
8142043	1702.65605	99	82063911	102.13104	115
8142043	1702.65605	112	82065120	102.13108	116
8142044	1702.65606	99	82065607	102.13102	115
8142044	1702.65606	112	82065609	102.13103	115
8142919	011111	92	82072463	102.13106	115
8143670	2402.53101	113	82076158	1102.13503	120
8144107	202.75247	94	82076266	1102.13502	120
8144108	202.75246	94	82078418	1602.13806	121
8144454	402.89329	78	82090731	402.14089	129
8144454	402.89329	95	82090733	402.14087	129
8144455	102.44455	93	82090735	402.14088	129
8144482	102.44482	77	82101910	402.14095	130
8144482	102.44482	93	82101912	402.14093	129
8144551	202.44551	94	82101914	402.14094	130
8144552	202.44552	94	82107271	1402.14501	133
8151345	1002.51346	91	82110404	202.14209	127
8152722	402.88888	78	82114500	1602.13804	121
8152722	402.88888	95	82114502	1102.13506	121
8155808	202.55807	94	82114504	1102.13507	121
8155808	202.55808	94	82114506	1602.13805	121
8156551	202.56551	94	82116545	1602.13811	80
8156552	202.56552	94	82116545	1602.13811	121
8156556	202.55807	94	82131055	702.14900	131
8156556	1002.56556	99	82136982	302.14103	128
8158216	402.58216	89	82141521	302.14102	128
8189092	1202.89093	98	82141524	202.14208	127
8189093	1202.89092	98	82141971	302.14107	129
8189195	202.75247	94	82142327	1002.14033	132
8189196	202.75246	94	82142329	1002.14021	132
8189300	202.75247	94	82142373	302.14106	129
8189301	202.75246	94	82151157	1602.14809	86
8189310	702.01216	96	82151157	1602.14809	133
8189318	702.01212	96	82151205	1602.14810	86
8189329	402.89329	78	82151205	1602.14810	133
8189329	402.89329	95	82151654	1002.14032	132
8189337	402.88888	78	82151656	1002.14022	132
8189337	402.88888	95	82166469	702.14901	131
8191142	1602.81666	98	82171603	1002.14019	132
8191220	102.91220	93	82177794	102.14114	125
8191313	1002.91313	97	82178247	1402.14500	133
8191314	1002.91314	97	82180491	102.14111	125
8191315	1002.91315	97	82181355	202.14203	126
8191315	1002.91315	108	82208512	102.14110	125
8191401	1002.91401	97	82208564	1702.14604	135
8191402	1002.91402	97	82209788	1102.13501	120
8191406	102.64101	77	82209849	1102.13500	120
8191409	1202.64701	78	82213089	1002.14002	131
8191412	1202.64700	78	82219161	102.14115	126

ALL ITEMS MENTIONED IN OUR CATALOGUE ARE NOT ORIGINAL PARTS BUT PERFECTLY INTERCHANGEABLE WITH THEM.

GOVERNING LEGISLATIONS FOR THE SALE OF OUR PRODUCTS DIFFER IN EACH COUNTRY.

INFRINGEMENTS, IF ANY, OF LOCAL LEGISLATIONS ARE RESPONSIBILITY OF THE RETAILER IN THE COUNTRY OF FINAL DISTRIBUTION.



82220161	102.14110	125	82637711	202.14210	84
82220206	102.14113	125	82637711	202.14210	127
82232959	1002.14001	131	82642339	402.31090	74
82248325	102.14108	125	82819477	302.14104	128
82248327	102.14105	124	82819482	302.14105	128
82248338	102.14106	125	82846107	1002.14026	132
82248340	102.14107	125	82846112	1002.14025	132
82252302	1002.13002	119	82846116	102.14118	126
82255346	102.14112	125	82846118	102.14119	126
82258426	102.14109	125	82849894	1502.14001	86
82268557	502.14505	131	82849894	1502.14001	123
82268562	502.14506	131	82849894	1502.14001	136
82285617	102.14116	126	82849905	1502.14100	86
82298483	102.14122	126	82849905	1502.14100	87
82298657	102.14113	125	82849905	1502.14100	123
82304585	1602.13798	122	82849905	1502.14100	123
82304599	1602.13799	122	82849905	1502.14100	136
82328081	202.14204	127	82849905	1502.14100	136
82328082	202.14205	127	82849923	1502.14000	86
82356810	502.14503	130	82849923	1502.14000	123
82356824	502.14504	130	82849923	1502.14000	136
82359214	502.14502	130	82849925	1502.14002	87
82360122	102.14100	124	82849925	1502.14002	123
82367098	1102.13501	120	82849925	1502.14002	136
82367957	1102.13500	120	82858486	102.14103	124
82409793	102.66113	83	82858516	102.14104	124
82410206	102.66114	83	82859306	1002.14018	132
82419488	102.66108	83	82884080	1102.14603	133
82419490	102.66107	83	82884084	1102.14602	133
82430056	102.66103	82	82928883	1002.14031	132
82430057	102.66104	82	82943356	502.14500	130
82431911	102.66101	82	82943538	502.14501	130
82444204	102.66111	83	82943981	1002.14030	132
82446592	1102.14605	133	82944866	502.14507	131
82448104	102.66106	83	82945196	502.14508	131
82448110	102.66105	83	82992301	402.31095	75
82453926	1102.14604	133	82992302	402.31094	75
82454671	102.66112	83	84000742	402.31091	74
82454672	102.66109	83	84004927	502.14509	131
82455156	102.66110	83	84004929	502.14510	131
82462702	1102.14609	133	84007259	202.14207	83
82462703	1102.14608	133	84007259	202.14207	127
82483073	1502.14006	76	84014254	702.14900	131
82483073	1502.14006	87	84024496	102.14117	126
82483073	1502.14006	136	84025799	1002.14029	132
82483074	1502.14005	76	84025801	1002.14027	132
82483074	1502.14005	87	84026559	1002.14028	132
82483074	1502.14005	136	84027588	102.14102	124
82491903	102.14101	124	84027783	1102.66602	86
82497193	1901.30703	73	84028392	1102.66603	86
82497194	1901.30702	73	84033228	102.14115	126
82523575	102.31101	74	84034942	1102.14608	133
82523847	402.31093	75	84034945	1102.14609	133
82523848	402.31092	75	84046776	102.14117	126
82524665	402.31097	75	84058023	102.14116	126
82526640	1602.31601	76	84086799	102.66102	82
82531174	402.31096	75	84096588	202.14205	127
82532284	1602.31600	76	84096589	202.14204	127
82534527	402.31099	75	84104142	1002.66001	85
82534529	402.31098	75	84104144	1002.66000	85
82637695	202.14207	83	84122332	1502.14101	76
82637695	202.14207	127	84122332	1502.14101	76
82637710	202.14211	84	84122332	1502.14101	87
82637710	202.14211	127	84122332	1502.14101	87



84122332	1502.14101	136	-	005931	178
84122332	1502.14101	136	-	005932	178
84139886	1102.14609	133	-	011112	178
84139933	1102.14608	133	-	011114	177
84151777	102.14121	82	-	011115	177
84151824	102.14120	82	-	011115	178
84162402	102.66100	82	-	503.44003	169
84162403	102.66101	82	-	503.44004	169
84167321	502.14510	131	-	503.44005	169
84195505	1502.14001	86	-	503.44006	169
84195505	1502.14001	123	-	503.44007	169
84195505	1502.14001	136	-	503.44008	169
84195519	1502.14002	87	-	503.45003	170
84195519	1502.14002	123	-	503.45004	170
84195519	1502.14002	136	-	503.45005	170
84195521	1502.14000	86	-	503.45006	170
84195521	1502.14000	123	-	503.45007	170
84195521	1502.14000	136	-	503.45008	170
84195623	402.14087	129	-	703.45503	171
84233571	202.14200	126	-	1500.00000	161
84429873	3002.00000	136	-	1500.00000	178
84441759	1502.14005	76	-	1500.00000	188
84441759	1502.14005	87	-	1500.00000	193
84441759	1502.14005	136	-	1500.00001	161
84441760	1502.14006	76	-	1500.00001	178
84441760	1502.14006	87	-	1500.00001	188
84441760	1502.14006	136	-	1500.00001	193
84441766	1502.14001	86	-	1503.45000	161
84441766	1502.14001	123	-	1503.45000	178
84441766	1502.14001	136	-	1503.45000	188
84441767	1502.14002	87	-	1503.45000	193
84441767	1502.14002	123	-	1503.45000	205
84441767	1502.14002	136	-	1503.45001	161
84441768	1502.14000	86	-	1503.45001	178
84441768	1502.14000	123	-	1503.45001	188
84441768	1502.14000	136	-	1503.45001	193
84441936	1502.14003	76	-	1503.45001	205
84441936	1502.14003	87	-	1503.45002	161
84441936	1502.14003	136	-	1503.45002	178
84441937	1502.14004	76	-	1503.45002	188
84441937	1502.14004	87	-	1503.45002	194
84441937	1502.14004	136	-	1503.45002	206
84577628	102.66102	82	-	1503.45003	161
			-	1503.45003	178
			-	1503.45003	188
			-	1503.45003	194
			-	1503.45003	206
			-	1503.45005	162
			-	1503.45005	178
			-	1503.45005	188
			-	1503.45005	194
			-	1503.45005	206
			-	1503.45100	161
			-	1503.45100	161
			-	1503.45100	178
			-	1503.45100	178
			-	1503.45100	188
			-	1503.45100	188
			-	1503.45100	188
			-	1503.45100	193
			-	1503.45100	194
			-	1503.45100	205
			-	1503.45100	206
			-	1503.45101	161
			-	1503.45101	161

COS.SCA

SIMILAR ref.	COS.PEL ref.	PAG			
-	003092	161	-	1503.45003	178
-	003120	147	-	1503.45005	188
-	003120	161	-	1503.45005	194
-	003120	177	-	1503.45005	206
-	003120	188	-	1503.45100	161
-	003120	193	-	1503.45100	161
-	003120	205	-	1503.45100	178
-	003123	161	-	1503.45100	178
-	003123	177	-	1503.45100	188
-	003123	188	-	1503.45100	188
-	003123	193	-	1503.45100	193
-	005727	177	-	1503.45100	194
-	005731	177	-	1503.45100	205
-	005732	177	-	1503.45100	206
-	005733	178	-	1503.45101	161
-	005734	178	-	1503.45101	161

ALL ITEMS MENTIONED IN OUR CATALOGUE ARE NOT ORIGINAL PARTS BUT PERFECTLY INTERCHANGEABLE WITH THEM.

GOVERNING LEGISLATIONS FOR THE SALE OF OUR PRODUCTS DIFFER IN EACH COUNTRY.

INFRINGEMENTS, IF ANY, OF LOCAL LEGISLATIONS ARE RESPONSIBILITY OF THE RETAILER IN THE COUNTRY OF FINAL DISTRIBUTION.



-	1503.45101	162	1346163	1403.46005	187
-	1503.45101	178	1346164	1403.46006	146
-	1503.45101	178	1346164	1403.46006	187
-	1503.45101	178	1346380	503.45011	170
-	1503.45101	188	1346683	503.44015	169
-	1503.45101	188	1346684	503.44016	169
-	1503.45101	188	1349783	1603.85411	159
-	1503.45101	193	1349784	1603.87150	159
-	1503.45101	194	1350339	005930	150
-	1503.45101	194	1350340	005920	150
-	1503.45101	205	1350343	011111	150
-	1503.45101	206	1351193	303.11051	141
-	1503.45101	206	1351193	303.11051	155
-	1903.45300	176	1351194	303.11050	141
-	1903.45301	176	1351194	303.11050	155
-	3003.00000	177	1351203	1003.00016	142
(1523607 rinforzo)	1003.00019	142	1351203	1003.00016	158
(1523607 rinforzo)	1003.00019	158	1354593	303.11053	141
(1523607 rinforzo)	1003.00023	142	1354593	303.11053	156
(1523607 rinforzo)	1003.00023	158	1354594	303.11052	141
(1523608 rinforzo)	1003.00020	142	1354594	303.11052	156
(1523608 rinforzo)	1003.00020	158	1355655	703.45500	171
(1523608 rinforzo)	1003.00024	142	1357599	203.44599	140
(1523608 rinforzo)	1003.00024	158	1357599	203.44599	154
1110057	303.10057	151	1357599	203.44599	166
1110058	303.10058	151	1357599	203.44599	184
1300831	1103.00831	150	1357599	203.44599	190
1300832	1103.00831	150	1357600	203.44600	140
1302696	103.43421	148	1357600	203.44600	155
1303318	403.03318	149	1357600	203.44600	166
1306492	2403.44100	147	1357600	203.44600	184
1306492	2403.44100	176	1357600	203.44600	190
1306975	1703.20075	152	1357601	203.95277	155
1306976	1703.20074	152	1357601	203.95277	166
1308473	1603.13073	150	1357601	203.95277	185
1308474	1603.13074	150	1357601	203.95277	191
1309584	1403.09585	152	1357601	203.95278	155
1309585	1403.09584	152	1357601	203.95278	166
1313592	203.13592	148	1357601	203.95278	185
1313592	203.13592	151	1357601	203.95278	191
1313594	203.13594	148	1357602	203.57601	140
1313594	203.13594	151	1357602	203.57601	155
1317538	103.08292	138	1357602	203.57601	166
1324596	403.24596	156	1357602	203.57601	184
1324597	403.24597	156	1357602	203.57601	190
1324598	403.24598	156	1357602	203.57602	140
1324599	1103.24599	143	1357602	203.57602	155
1324599	1103.24599	159	1357602	203.57602	166
1324600	1103.24600	143	1357602	203.57602	184
1324600	1103.24600	159	1357602	203.57602	191
1324605	203.08469	154	1358315	1003.00023	142
1324606	203.08470	154	1358315	1003.00023	158
1325265	203.25265	151	1358316	1003.00024	142
1325266	203.25266	151	1358316	1003.00024	158
1326523	1003.00003	152	1358831	1603.22991	160
1326524	1003.00004	152	1358832	1603.22992	160
1329551	403.29551	152	1362691	1003.00031	158
1329552	403.29552	152	1362707	1603.44707	159
1334054	103.43450	151	1362707	1603.44707	174
1335391	203.08465	140	1362708	203.68651	140
1335391	203.08465	154	1362708	203.68651	154
1335392	203.08466	140	1362708	203.68651	165
1335392	203.08466	154	1364665	203.08467	154
1346163	1403.46005	146	1364666	203.08468	154



1366141	503.44017	169	1383858	203.95275	184
1366243	103.43134	139	1383858	203.95275	191
1366243	103.43134	154	1383858	203.95278	155
1366287	1003.00011	142	1383858	203.95278	166
1366287	1003.00011	157	1383858	203.95278	185
1366288	1003.00012	142	1383858	203.95278	191
1366288	1003.00012	157	1383858	1003.00144	143
1366384	103.43124	139	1383858	1003.00144	160
1366384	103.43124	153	1383858	1003.00144	176
1366736	103.01929	153	1383858	1003.00144	205
1366832	103.43134	139	1383887	1003.00011	142
1366832	103.43134	154	1383887	1003.00011	157
1366847	1903.45303	160	1383888	1003.00012	142
1366847	1903.45303	176	1383888	1003.00012	157
1366848	1903.45302	160	1385402	1603.67003	159
1366848	1903.45302	176	1385403	1603.67004	159
1366849	1903.45305	160	1385410	1603.85411	159
1366849	1903.45305	176	1385966	2103.44080	160
1366850	1903.45304	160	1386957	903.23235	141
1366850	1903.45304	176	1386958	903.23236	141
1368652	203.68652	140	1386959	903.86961	141
1368652	203.68652	154	1386960	903.86962	141
1368652	203.68652	165	1387155	1603.87150	159
1370107	903.86959	141	1390074	303.11054	141
1370108	903.86960	141	1390074	303.11054	156
1370329	903.23233	157	1390075	303.11055	141
1370330	903.23234	157	1390075	303.11055	156
1370707	2103.44080	160	1390076	1003.00015	142
1371754	103.97573	139	1390076	1003.00015	158
1371757	103.71757	153	1391144	003006	159
1371758	103.71758	153	1393447	1003.00012	142
1371856	103.43144	153	1393447	1003.00012	157
1374642	2403.44101	147	1395276	203.95275	140
1374642	2403.44101	177	1395276	203.95275	155
1376832	403.76832	141	1395276	203.95275	166
1380819	011211	161	1395276	203.95275	184
1380819	011211	178	1395276	203.95275	191
1380819	011211	179	1395276	203.95276	141
1381479	1003.00013	142	1395276	203.95276	155
1381479	1003.00013	157	1395276	203.95276	166
1381480	1003.00014	142	1395276	203.95276	184
1381480	1003.00014	157	1395276	203.95276	191
1381563	1003.00009	142	1395871	403.24599	156
1381563	1003.00009	157	1396529	503.45013	170
1381564	1003.00010	142	1396530	503.45012	170
1381564	1003.00010	157	1396542	503.44014	169
1381565	903.70103	157	1397570	103.43144	153
1381566	903.70102	157	1397571	103.97571	139
1382727	903.70101	157	1400207	1603.22991	160
1382728	903.70100	157	1400208	1603.22992	160
1383520	1003.00007	142	1400213	403.24596	156
1383520	1003.00007	157	1400899	1003.00019	142
1383520	1003.00007	172	1400899	1003.00019	158
1383609	103.83609	154	1400900	1003.00020	142
1383858	203.48241	201	1400900	1003.00020	158
1383858	203.48243	201	1401929	103.01929	153
1383858	203.57601	140	1401931	103.97572	139
1383858	203.57601	155	1406223	1703.30223	143
1383858	203.57601	166	1406224	1703.30224	143
1383858	203.57601	184	1406613	1903.14351	150
1383858	203.57601	190	1406614	1903.14350	150
1383858	203.95275	140	1406627	503.44009	169
1383858	203.95275	155	1406628	503.44018	169
1383858	203.95275	166	1406634	503.44010	169

ALL ITEMS MENTIONED IN OUR CATALOGUE ARE NOT ORIGINAL PARTS BUT PERFECTLY INTERCHANGEABLE WITH THEM.

GOVERNING LEGISLATIONS FOR THE SALE OF OUR PRODUCTS DIFFER IN EACH COUNTRY.

INFRINGEMENTS, IF ANY, OF LOCAL LEGISLATIONS ARE RESPONSIBILITY OF THE RETAILER IN THE COUNTRY OF FINAL DISTRIBUTION.



1408465	203.08465	140	1451270	103.46163	183
1408465	203.08465	154	1451271	103.46162	145
1408466	203.08466	140	1451271	103.46162	183
1408466	203.08466	154	1451527	103.46143	165
1412392	011214	161	1451528	103.46144	165
1421090	2103.44080	160	1457887	1003.00023	142
1422843	403.45137	145	1457887	1003.00023	158
1422843	403.45137	168	1457888	1003.00024	142
1422991	1603.22991	160	1457888	1003.00024	158
1422992	1603.22992	160	1457895	1003.00019	142
1423017	1703.30221	160	1457895	1003.00019	158
1423017	1703.30221	175	1457896	1003.00020	142
1423018	1703.30220	160	1457896	1003.00020	158
1423018	1703.30220	175	1459133	103.45142	163
1425051	1003.45054	159	1459134	103.45143	144
1425052	1003.45055	159	1459134	103.45143	163
1426927	1703.30225	143	1459135	103.45144	144
1429393	203.08469	154	1459135	103.45144	163
1429394	203.08470	154	1459141	103.45147	145
1431256	1603.67002	160	1459141	103.45147	164
1431257	1603.67001	160	1459142	103.45148	145
1431920	1103.45531	173	1459142	103.45148	164
1431921	1103.45530	173	1459145	103.45150	164
1431922	1103.45533	173	1459146	103.45152	144
1431923	1103.45532	173	1459146	103.45152	164
1431924	403.45129	167	1459488	103.45139	164
1431925	403.45131	168	1466031	103.45141	163
1431926	403.45132	168	1466032	103.45140	163
1431931	203.45203	165	1467000	1603.67001	160
1431932	203.45204	165	1467003	1603.67002	160
1431933	203.45201	165	1471599	003006	159
1431934	203.45202	165	1479758	103.46165	165
1435542	2403.45100	177	1479759	103.46166	165
1435542	2403.45100	188	1481372	2403.43100	146
1438557	1103.45535	174	1481372	2403.43100	187
1438558	1103.45534	174	1481373	2403.43101	146
1439788	403.45133	145	1481373	2403.43101	187
1439788	403.45133	168	1482070	403.24599	156
1439789	403.45134	145	1482404	1003.00022	158
1439789	403.45134	168	1482405	1003.00021	158
1440108	1003.00009	142	1484076	503.45015	170
1440108	1003.00009	157	1484078	503.45017	156
1440113	1003.00010	142	1484078	503.45017	171
1440113	1003.00010	157	1484079	503.45016	156
1440780	1003.00026	158	1484079	503.45016	171
1440781	1003.00025	158	1484080	503.45014	156
1442294	1903.45305	160	1484080	503.45014	170
1442294	1903.45305	176	1485072	1703.30222	160
1442295	1903.45304	160	1485072	1703.30222	175
1442295	1903.45304	176	1485485	203.08465	140
1442653	303.45245	167	1485485	203.08465	154
1442654	303.45244	167	1485486	203.08466	140
1442655	203.46203	184	1485486	203.08466	154
1442705	503.44001	168	1486647	303.45241	167
1443864	503.44002	168	1486648	303.45240	167
1443884	003006	159	1488409	1703.30221	160
1446353	1603.45521	175	1488409	1703.30221	175
1446354	1603.45520	175	1488410	1703.30220	160
1446355	1603.45523	175	1488410	1703.30220	175
1446356	1603.45522	175	1495577	403.45127	168
1446587	1603.67001	160	1495578	403.45128	168
1446588	1603.67002	160	1495956	903.45229	171
1451246	103.45151	165	1495956	903.45229	186
1451270	103.46163	145	1495957	903.45228	171



1495957	903.45228	186	1543635	1103.24600	143
1496293	903.43163	146	1543635	1103.24600	159
1496294	903.43162	146	1544330	1703.30221	160
1496659	803.96659	157	1544330	1703.30221	175
1496666	803.96659	157	1544331	1703.30220	160
1498102	009490	178	1544331	1703.30220	175
1498103	009480	178	1548053	403.45140	146
1498179	303.45249	167	1549814	1603.45529	175
1498180	303.45248	167	1549815	1603.45530	175
1499230	403.24599	156	1721731	103.45151	165
1499231	403.76832	141	1721891	1003.45059	172
1501342	303.45251	167	1721892	1003.45058	172
1501343	303.45250	167	1721893	1003.45057	172
1504131	403.45130	167	1721894	1003.45056	172
1504608	005730	161	1723518	503.45009	170
1504609	005720	161	1723519	503.45010	170
1508182	005725	161	1725663	1003.00023	142
1508184	005726	161	1725663	1003.00023	158
1511775	2103.44080	160	1725664	1003.00024	142
1512423	303.45243	167	1725664	1003.00024	158
1512424	303.45242	167	1725671	1003.00019	142
1514524_5_6+1726328	103.45149	164	1725671	1003.00019	158
1515190	403.76832	141	1725672	1003.00020	142
1515194	303.11050	141	1725672	1003.00020	158
1515194	303.11050	155	1725675	1003.46237	173
1515195	303.11051	141	1725676	1003.46236	173
1515195	303.11051	155	1726851	1003.00010	142
1517649	203.08469	154	1726851	1003.00010	157
1517650	203.08470	154	1727991	1103.45535	174
1523508	403.45135	168	1727992	1103.45534	174
1523509	403.45136	168	1731206	403.45137	145
1523881	1003.45053	172	1731206	403.45137	168
1523882	1003.45052	172	1732322	303.45247	167
1529070	1603.22991	160	1732509	1603.67001	160
1529071	1603.22992	160	1732510	1603.67002	160
1529886	303.45246	167	1732515	1603.85412	159
1535039	1003.45051	172	1732776	503.44001	168
1535040	1003.45050	172	1732778	503.44002	168
1535045	1003.00016	142	1732782	503.44011	169
1535045	1003.00016	158	1732783	503.44012	169
1535048	1003.45048	172	1737413	002999	174
1535049	1003.00015	142	1742377	1003.00023	142
1535049	1003.00015	158	1742377	1003.00023	158
1535052	1003.45049	172	1742378	1003.00024	142
1536807	103.45146	145	1742378	1003.00024	158
1536807	103.45146	164	1742386	1003.00020	142
1537675	903.23236	141	1742386	1003.00020	158
1538383	103.45145	163	1743176	103.45139	164
1538384	903.45231	171	1743177	103.43101	144
1538384	903.45231	186	1743177	103.43101	164
1538385	903.45230	171	1746585	103.45151	165
1538385	903.45230	186	1746586	103.43102	145
1539870	703.45501	171	1747981	1603.45524	174
1539871	703.45502	171	1748085	103.45139	164
1540268	203.46201	184	1748086	103.43101	144
1540268	203.46201	190	1748086	103.43101	164
1540269	203.46200	184	1749716	903.45229	171
1540269	203.46200	190	1749716	903.45229	186
1541484	103.45153	173	1749717	903.45228	171
1543607	103.43100	144	1749717	903.45228	186
1543608	903.43161	146	1751405	903.45231	171
1543609	903.43160	146	1751405	903.45231	186
1543634	1103.24599	143	1751406	903.45230	171
1543634	1103.24599	159	1751406	903.45230	186

ALL ITEMS MENTIONED IN OUR CATALOGUE ARE NOT ORIGINAL PARTS BUT PERFECTLY INTERCHANGEABLE WITH THEM.

GOVERNING LEGISLATIONS FOR THE SALE OF OUR PRODUCTS DIFFER IN EACH COUNTRY.

INFRINGEMENTS, IF ANY, OF LOCAL LEGISLATIONS ARE RESPONSIBILITY OF THE RETAILER IN THE COUNTRY OF FINAL DISTRIBUTION.



1751661	103.43102	145	1791369	1503.45008	162
1755594	103.45145	163	1791369	1503.45008	179
1756751	1503.45006	147	1791369	1503.45008	189
1756751	1503.45006	162	1791369	1503.45008	206
1756751	1503.45006	178	1792374	1503.45010	179
1756751	1503.45006	189	1792375	1503.45011	179
1756751	1503.45006	206	1798863	903.45229	171
1756754	1503.45007	147	1798863	903.45229	186
1756754	1503.45007	162	1798864	903.45228	171
1756754	1503.45007	178	1798864	903.45228	186
1756754	1503.45007	189	1798980	1603.45526	174
1756754	1503.45007	206	1800467	1703.30229	143
1760551	1603.45527	175	1800468	1703.30230	143
1760554	1603.45528	175	1804628	103.45151	165
1763296	403.45137	145	1805341	203.46203	184
1763296	403.45137	168	1805342	203.46202	184
1765735	2103.44080	160	1805447	1003.45048	172
1765808	503.44012	169	1852569	1603.45521	175
1765809	503.44011	169	1852570	1603.45520	175
1765985	503.44001	168	1852572	1603.45523	175
1767265	503.44002	168	1852573	1603.45522	175
1767631	1703.30226	143	1853164	403.45139	146
1770301	1603.45525	174	1853165	403.45138	146
1779113	1003.46229	187	1853346	403.45131	168
1779114	1003.46228	187	1853347	403.45132	168
1779118	303.45251	167	1854227	303.45249	167
1779119	303.45250	167	1854228	303.45248	167
1779120	303.45241	167	1855164	2103.44080	160
1779121	303.45240	167	1856472	903.43162	146
1784669	1503.45103	147	1856473	903.43163	146
1784669	1503.45103	147	1856474	903.45228	171
1784669	1503.45103	162	1856474	903.45228	186
1784669	1503.45103	162	1856475	903.45229	171
1784669	1503.45103	178	1856475	903.45229	186
1784669	1503.45103	179	1857591	1703.30225	143
1784669	1503.45103	189	1858803	103.43102	145
1784669	1503.45103	189	1859174	103.46145	180
1784669	1503.45103	206	1865178	403.46102	186
1784669	1503.45103	206	1865178	403.46102	192
1784670	1503.45102	147	1865182	403.46091	185
1784670	1503.45102	147	1865182	403.46091	192
1784670	1503.45102	162	1865182	403.46090	185
1784670	1503.45102	162	1865183	403.46090	192
1784670	1503.45102	178	1865183	403.46090	192
1784670	1503.45102	179	1865186	403.46106	186
1784670	1503.45102	189	1865188	403.46084	185
1784670	1503.45102	189	1866913	103.46164	145
1784670	1503.45102	189	1866913	103.46164	183
1784670	1503.45102	206	1867654	1703.30231	143
1784670	1503.45102	206	1867655	1703.30232	143
1785530	1003.00022	158	1867658	1703.30233	176
1785531	1003.00021	158	1867659	1703.30234	176
1786692	1003.45053	172	1870592	103.46149	180
1786693	1003.45052	172	1870593	103.46150	180
1788757	803.46802	186	1870594	103.46151	180
1788758	803.46801	186	1870595	103.46159	181
1789305	1703.30223	143	1870596	103.46158	181
1789306	1703.30224	143	1870597	103.46153	182
1789311	1703.30231	143	1870598	103.46154	181
1789312	1703.30232	143	1870599	103.46155	181
1789317	1703.30233	176	1870689	103.43134	139
1789318	1703.30234	176	1870689	103.43134	154
1790006	1103.45531	173	1871667	103.46142	165
1790007	1103.45530	173	1872158	103.46146	180
1791369	1503.45008	147	1872159	103.46157	182



1872160	103.46148	182	1930811	103.47108	183
1875843	103.46160	182	1930812	103.47109	183
1875846	103.46156	182	1931613	1603.45533	174
1875847	103.46161	183	1931614	1603.45532	174
1875858	103.46160	182	1936674	1103.45531	173
1880736	103.45145	163	1936675	1103.45530	173
1880737	103.45143	144	1942252	1003.46231	187
1880737	103.45143	163	1942253	1003.46230	187
1884483	403.46087	185	1945731	503.44013	169
1884483	403.46087	191	1946923	303.47241	191
1884485	403.46085	185	1946924	303.47240	191
1884486	403.46086	185	1947568	203.45206	165
1884914	403.46089	185	1947568	203.45206	183
1884914	403.46089	191	1947568	203.45206	190
1884915	403.46088	185	1947569	203.45205	165
1884915	403.46088	191	1947569	203.45205	183
1885932	103.46147	181	1947569	203.45205	190
1885996	403.46103	186	1949900	1603.45531	174
1889297	1003.43101	146	2000390	002999	174
1889298	1003.43100	146	2005369	1703.30221	160
1889299	1003.46103	172	2005369	1703.30221	175
1889299	1003.46103	186	2005370	1703.30220	160
1889300	1003.46102	172	2005370	1703.30220	175
1889300	1003.46102	186	2008861	103.43102	145
1890176	103.46152	182	2021575	1503.45006	147
1890728	103.47106	183	2021575	1503.45006	162
1890787	103.46152	182	2021575	1503.45006	178
1892322	1603.45527	175	2021575	1503.45006	189
1892324	1603.45528	175	2021575	1503.45006	206
1894478	2103.44080	160	2021576	1503.45008	147
1900349	1603.45527	175	2021576	1503.45008	162
1900351	1603.45528	175	2021576	1503.45008	179
1902355	1703.30227	176	2021576	1503.45008	189
1902356	1703.30228	176	2021576	1503.45008	206
1902975	1703.30223	143	2021578	1503.45009	147
1902976	1703.30224	143	2021578	1503.45009	162
1904814	103.43102	145	2021578	1503.45009	179
1910437	1603.45526	174	2021578	1503.45009	189
1917216	103.46145	180	2021578	1503.45009	206
1923742	403.46101	185	2021579	1503.45007	147
1923742	403.46101	192	2021579	1503.45007	162
1923743	403.46100	185	2021579	1503.45007	178
1923743	403.46100	192	2021579	1503.45007	189
1923744	403.46105	186	2021579	1503.45007	206
1923744	403.46105	192	2026618	203.68651	140
1923745	403.46104	186	2026618	203.68651	154
1923745	403.46104	192	2026618	203.68651	165
1927257	1003.45059	172	2026619	203.68652	140
1927258	1003.45058	172	2026619	203.68652	154
1927259	1003.46235	173	2026619	203.68652	165
1927260	1003.46234	173	2026620	203.68651	140
1927261	1003.46233	173	2026620	203.68651	154
1927262	1003.46232	173	2026620	203.68651	165
1928063	1603.45535	175	2026621	203.68652	140
1928063	1603.45535	187	2026621	203.68652	154
1928063	1603.45535	193	2026621	203.68652	165
1930649	1703.30225	143	2031054	1603.45533	174
1930792	103.47100	181	2031055	1603.45532	174
1930793	103.47101	181	2031866	2403.43100	146
1930794	103.47102	181	2031866	2403.43100	187
1930799	103.47107	182	2031868	2403.43101	146
1930800	103.47103	183	2031868	2403.43101	187
1930805	103.47104	181	2031872	2403.45101	177
1930806	103.47105	182	2031872	2403.45101	188

ALL ITEMS MENTIONED IN OUR CATALOGUE ARE NOT ORIGINAL PARTS BUT PERFECTLY INTERCHANGEABLE WITH THEM.

GOVERNING LEGISLATIONS FOR THE SALE OF OUR PRODUCTS DIFFER IN EACH COUNTRY.

INFRINGEMENTS, IF ANY, OF LOCAL LEGISLATIONS ARE RESPONSIBILITY OF THE RETAILER IN THE COUNTRY OF FINAL DISTRIBUTION.



2052103	1603.45525	174	2129987	1503.45006	206
2052117	1603.44707	159	2129988	1503.45008	147
2052117	1603.44707	174	2129988	1503.45008	162
2054579	1003.45057	172	2129988	1503.45008	179
2054580	1003.45056	172	2129988	1503.45008	189
2054581	1003.45059	172	2129988	1503.45008	206
2054582	1003.45058	172	2129991	1503.45102	147
2054583	1003.46235	173	2129991	1503.45102	147
2054584	1003.46234	173	2129991	1503.45102	162
2054585	1003.46233	173	2129991	1503.45102	162
2054586	1003.46232	173	2129991	1503.45102	178
2054589	1003.46231	187	2129991	1503.45102	179
2054590	1003.46230	187	2129991	1503.45102	189
2054601	1003.00023	142	2129991	1503.45102	189
2054601	1003.00023	158	2129991	1503.45102	206
2054602	1003.00024	142	2129991	1503.45102	206
2054602	1003.00024	158	2129992	1503.45103	147
2054603	1003.00019	142	2129992	1503.45103	147
2054603	1003.00019	158	2129992	1503.45103	162
2055972	903.47600	193	2129992	1503.45103	162
2055973	903.47601	193	2129992	1503.45103	178
2057119	1003.00023	142	2129992	1503.45103	179
2057119	1003.00023	158	2129992	1503.45103	189
2057120	1003.00024	142	2129992	1503.45103	189
2057120	1003.00024	158	2129992	1503.45103	206
2058757	703.47700	192	2129992	1503.45103	206
2077926	403.48095	203	2141714	1003.46805	176
2077927	403.48094	203	2145647	1703.30221	160
2077928	403.48093	202	2145647	1703.30221	175
2080688	1603.45523	175	2145648	1703.30220	160
2080689	1603.45522	175	2145648	1703.30220	175
2080828	002999	174	2162652	903.47603	193
2083830	1603.45535	175	2162653	903.47602	193
2083830	1603.45535	187	2165863	903.43161	146
2083830	1603.45535	193	2165864	903.43160	146
2093720	1003.00022	158	2182273	1003.46804	173
2093721	1003.00021	158	2183823	103.48133	198
2117867	703.47701	192	2183824	103.48132	198
2117868	703.47702	192	2196771	1003.46803	173
2117870	703.47703	192	2226744	1003.48110	204
2117871	703.47701	192	2226746	1003.48109	204
2124015	1103.45533	173	2229102	303.48106	202
2126392	403.46102	186	2230750	903.48601	203
2126392	403.46102	192	2230751	903.48600	203
2126955	903.47605	193	2230756	903.48603	203
2126956	903.47604	193	2230757	903.48602	203
2127431	1603.45533	174	2234214	1003.48108	204
2127432	1603.45532	174	2241544	1603.45534	175
2128511	403.48101	203	2241826	1603.46501	187
2128512	403.48102	203	2241827	1603.46500	187
2129985	1503.45007	147	2241828	1603.46503	187
2129985	1503.45007	162	2241829	1603.46502	187
2129985	1503.45007	178	2246818	203.48243	201
2129985	1503.45007	189	2246818	203.48244	201
2129985	1503.45007	206	2246819	203.48241	201
2129986	1503.45009	147	2246819	203.48242	201
2129986	1503.45009	162	2246830	203.48211	199
2129986	1503.45009	179	2246831	203.48210	199
2129986	1503.45009	189	2246834	203.48234	200
2129986	1503.45009	206	2248103	1603.45521	175
2129987	1503.45006	147	2248114	1603.45520	175
2129987	1503.45006	162	2286062	103.48122	197
2129987	1503.45006	178	2295948	403.48091	202
2129987	1503.45006	189	2295950	403.48092	202



2295953	403.48097	203	2349683	303.48103	202
2295955	403.48098	203	2349684	303.48102	202
2297701	103.48101	195	2349685	303.48103	202
2297703	103.48102	195	2349686	303.48102	202
2297983	203.48201	198	2349687	303.48108	202
2297984	203.48200	198	2360072	1003.48101	204
2297985	203.48225	200	2365426	103.48134	198
2297986	203.48224	200	2365443	103.48135	198
2297987	203.48221	199	2371254	1703.30221	160
2297988	203.48220	199	2371254	1703.30221	175
2297989	203.48219	199	2371255	1703.30220	160
2297990	203.48218	199	2371255	1703.30220	175
2297991	203.48205	198	2373889	1603.48603	205
2297992	203.48204	198	2379890	1603.48601	205
2297993	203.48209	199	2379893	1603.48602	205
2297994	203.48208	199	2379894	1603.48600	205
2297995	203.48207	199	2392771	103.48123	197
2297996	203.48206	199	2394400	1103.48903	205
2297997	203.48231	200	2394401	1103.48902	205
2297998	203.48230	200	2402012	903.48607	204
2298022	203.48236	200	2402035	903.48606	204
2298045	203.48237	201	2402039	903.48605	204
2298046	203.48238	201	2402042	903.48604	204
2302630	203.48239	201	2403511	203.48203	198
2302631	203.48240	201	2403512	203.48202	198
2304657	203.48215	199	2403513	203.48223	200
2304658	203.48214	199	2403514	203.48222	200
2304659	203.48233	200	2403515	203.48217	199
2304660	203.48232	200	2403516	203.48216	199
2304661	203.48229	200	2416136	1603.46503	187
2304662	203.48228	200	2416137	1603.46502	187
2304675	203.48213	199	2442629	1603.45527	175
2304676	203.48212	199	2442631	1603.45528	175
2304677	203.48227	200	2442637	1603.45534	175
2304678	203.48226	200	2442689	1603.45524	174
2305632	103.48112	196	2443019	103.48103	195
2307678	103.48105	195	2443020	103.48104	195
2307679	103.48100	195	2443021	203.48235	200
2310450	103.48115	196	2476494	1003.46231	187
2311419	403.48090	202	2476495	1003.46230	187
2311420	403.48096	203	2492751	1003.48103	204
2311423	403.48099	203	2492752	1003.48102	204
2311424	403.48103	203	2502345	103.48121	197
2311427	403.48100	203	2507857	103.48131	198
2311428	403.48104	203	2507858	103.48130	198
2324292	103.48125	197	2533983	1103.48902	205
2324293	103.48124	197	2535458	103.48136	198
2324296	103.48127	197	2542870	103.48120	197
2324347	103.48126	197	2559297	303.48105	202
2324348	103.48129	197	2559298	303.48104	202
2324349	103.48128	197	2559301	303.48105	202
2324352	103.48107	195	2559302	303.48104	202
2324353	103.48106	195	2559303	303.48101	201
2324355	103.48109	196	2559304	303.48100	201
2324356	103.48111	196	2559305	303.48106	202
2324367	103.48110	196	2559306	303.48107	202
2324368	103.48113	196	2559309	303.48101	201
2324369	103.48114	196	2559310	303.48100	201
2329044	103.48116	196	2584635	103.48113	196
2329046	103.48117	196	2584637	103.48114	196
2329070	103.48108	196	2592644	1103.48901	205
2334727	1603.48607	205	2592645	1103.48900	205
2334728	1603.48606	205	2599549	203.48237	201
2341865	1003.48100	204	2599550	203.48238	201

ALL ITEMS MENTIONED IN OUR CATALOGUE ARE NOT ORIGINAL PARTS BUT PERFECTLY INTERCHANGEABLE WITH THEM.

GOVERNING LEGISLATIONS FOR THE SALE OF OUR PRODUCTS DIFFER IN EACH COUNTRY.

INFRINGEMENTS, IF ANY, OF LOCAL LEGISLATIONS ARE RESPONSIBILITY OF THE RETAILER IN THE COUNTRY OF FINAL DISTRIBUTION.



2614805	103.48119	197	-	1500.00001	229
2614806	103.48118	197	-	1500.00001	234
2655840	1603.48603	205	-	1500.00001	249
2655841	1603.48602	205	-	1503.45100	250
2655842	1603.48601	205	-	1503.45100	250
2655843	1603.48600	205	-	1503.45100	260
288177	203.42433	148	-	1503.45100	260
288178	203.42434	148	-	1503.45100	270
296538	503.11111	149	-	1503.45100	270
316756	703.00001	149	-	1503.45101	250
316918	503.55555	149	-	1503.45101	250
330749	403.00001	149	-	1503.45101	260
350419	203.50419	149	-	1503.45101	260
350420	203.50420	149	-	1503.45101	270
376243	503.22222	149	-	1503.45101	270
388169	203.42431	148	-	1504.10607	250
388170	203.42432	148	-	1504.10607	260
388309	1203.25251	138	-	1504.10607	270
388311	1203.24241	150	-	1504.10608	250
388312	1203.24242	150	-	1504.10608	260
390303	903.23231	150	-	1504.10608	270
390304	903.23232	150	-	1504.10609	250
391555	1003.00005	150	-	1504.10609	260
393356	1103.39395	152	-	1504.10609	270
393357	1103.39396	152	-	1504.10610	250
581025	1703.30222	160	-	1504.10610	260
581025	1703.30222	175	-	1504.10610	270
581076	1003.00001	150	-	3004.00001	239
			-	3004.00001	249
			-	3004.00002	269
			0159149	1704.10567	238
			0159149	1704.10567	248
			0159149	1704.10567	258
			0159149	1704.10567	268
			0159150	1704.10566	238
			0159150	1704.10566	248
			0159150	1704.10566	258
			0159150	1704.10566	268
			0393391	2104.95080	248
			0673143	1004.00013	245
			0673144	1004.00014	245
			0699854	502.99017	238
			0750899	1004.10028	226
			081110	404.81110	237
			081140	304.81151	237
			081150	304.81150	237
			084096	304.84097	220
			084097	304.84096	220
			085487	204.85487	236
			085488	204.85488	236
			085510	404.85510	237
			085511	404.85510	237
			0948779	404.10541	242
			0948779	404.10541	253
			0962101	1004.10022	225
			0962643	1004.00010	245
			096755	404.96755	237
			096756	404.96756	237
			096757	1104.96757	238
			096758	1104.96758	238
			1227146	204.85487	236
			1227147	204.85488	236
			1232015	502.99013	237
			1234554	3004.00000	229

COS.DA

SIMILAR ref.	COS.PEL ref.	PAG			
-	003119	234			
-	003119	249			
-	003119	259			
-	003119	269			
-	003120	212			
-	003120	229			
-	003121	212			
-	003122	212			
-	003122	229			
-	003122	249			
-	003122	259			
-	003123	229			
-	003123	234			
-	003123	249			
-	006132	259			
-	006133	259			
-	011112	259			
-	304.10512	252			
-	304.10513	252			
-	304.10514	252			
-	304.10515	252			
-	304.95736	242			
-	304.95737	242			
-	404.95090	242			
-	1004.10531	265			
-	1004.10533	265			
-	1404.95613	227			
-	1404.95614	227			
-	1500.00000	229			
-	1500.00000	234			
-	1500.00000	249			



1238280	2404.95100	249	1317126	404.17126	242
1246301	404.46301	221	1319678	1004.00003	244
1272653	0111111	239	1319679	1004.00002	244
1272653	0111111	249	1328724	1704.63701	221
1272653	0111111	250	1328724	1704.63701	228
1284211	005910	239	1328725	1704.63700	221
1284212	005900	239	1328725	1704.63700	228
1290191	404.90191	242	1328860	1604.10583	247
1291172	204.91173	241	1328861	1604.10582	247
1291173	204.91172	241	1328934	204.28932	220
1294948	1104.99049	246	1328934	204.28932	223
1294949	1104.99048	246	1328934	204.28932	236
1295619	1404.95619	247	1328934	204.28932	241
1295619	1404.95619	257	1328934	204.28932	251
1295620	1404.95620	247	1328934	204.28934	220
1295620	1404.95620	257	1328934	204.28934	223
1295732	304.95735	242	1328934	204.28934	236
1295735	304.95732	242	1328934	204.28934	241
1295910	2104.95080	248	1328934	204.28934	251
1296590	1704.10565	238	1328935	204.28933	220
1296590	1704.10565	248	1328935	204.28933	223
1296590	1704.10565	258	1328935	204.28933	236
1296590	1704.10565	268	1328935	204.28933	241
1296591	1704.10564	238	1328935	204.28933	251
1296591	1704.10564	248	1328935	204.28935	220
1296591	1704.10564	258	1328935	204.28935	223
1296591	1704.10564	268	1328935	204.28935	237
1297699	304.84097	220	1328935	204.28935	241
1297700	304.84096	220	1328935	204.28935	252
1298974	704.63400	225	1328945	804.02007	244
1299417	904.99417	238	1329523	1004.00005	244
1299417	904.99417	244	1329524	1004.00004	244
1299418	904.99418	238	1329718	003001	211
1299418	904.99418	244	1329718	003001	227
1300041	404.27140	242	1329718	003001	247
1300557	704.10501	243	1329718	003001	257
1300557	704.10501	255	1334108	1604.10587	247
1302983	904.80063	238	1334109	1604.10586	247
1302983	904.80063	244	1340450	204.28933	220
1302984	904.80062	238	1340450	204.28933	223
1302984	904.80062	244	1340450	204.28933	236
1303892	003001	211	1340450	204.28933	241
1303892	003001	227	1340450	204.28933	251
1303892	003001	247	1340450	204.28937	241
1303892	003001	257	1340450	204.28937	252
1303943	1004.00007	244	1340450	1001.00001	228
1303944	1004.00006	244	1340450	1001.00001	238
1305462	502.44444	237	1340450	1001.00001	248
1305479	1704.10563	248	1340450	1001.00001	259
1305480	1704.10562	248	1347131	1004.00007	244
1305481	1704.10561	248	1347132	1004.00006	244
1305481	1704.10561	258	1353295	502.99011	237
1305482	1704.10560	248	1354702	1904.95651	248
1305482	1704.10560	258	1354702	1904.95651	259
1308687	704.10500	243	1354703	1904.95650	248
1308687	704.10500	255	1354703	1904.95650	259
1308794	1104.99047	246	1362870	904.72003	225
1308795	1104.99046	246	1362871	904.72002	225
1309400	104.09400	240	1363278	804.02007	244
1309401	104.09401	240	1363373	1104.63373	226
1311329	604.00095	243	1363374	1104.63374	226
1312789	104.12789	240	1363375	404.63375	223
1312864	704.63400	225	1363817	204.37810	222
1312868	704.63400	225	1364798	304.64799	223

ALL ITEMS MENTIONED IN OUR CATALOGUE ARE NOT ORIGINAL PARTS BUT PERFECTLY INTERCHANGEABLE WITH THEM.

GOVERNING LEGISLATIONS FOR THE SALE OF OUR PRODUCTS DIFFER IN EACH COUNTRY.

INFRINGEMENTS, IF ANY, OF LOCAL LEGISLATIONS ARE RESPONSIBILITY OF THE RETAILER IN THE COUNTRY OF FINAL DISTRIBUTION.



1364799	304.64798	223	1400753	1904.55551	219
1366253	1004.10021	225	1400754	1904.55550	212
1366254	1004.10020	225	1400754	1904.55550	216
1368836	1004.10021	225	1400754	1904.55550	219
1368837	1004.10020	225	1400769	1701.53601	212
1371224	1004.10557	265	1400778	1701.53600	212
1371225	1004.10556	265	1401713	1501.03001	213
1371226	1004.10556	265	1401713	1501.03001	229
1371329	2104.85080	228	1401731	1501.03000	213
1372532	904.72001	225	1401731	1501.03000	229
1372533	904.72000	225	1401818	1004.55003	211
1372534	104.72534	222	1401819	1004.55002	211
1372535	104.72535	222	1401824	404.55091	209
1372540	2404.63100	228	1401828	104.55011	208
1372801	1104.63375	226	1404308	1004.55001	211
1372802	1104.63376	226	1404308	1004.55001	215
1374568	1904.72751	228	1404871	501.53500	210
1374569	1904.72750	228	1404997	204.55022	209
1375876	104.72536	222	1404998	204.55023	209
1389296	204.69437	222	1405008	104.55010	208
1389296	204.69437	240	1405010	404.55094	209
1389297	204.69438	222	1405011	404.55093	209
1389297	204.69438	240	1405015	104.55011	208
1389563	201.28252	241	1405027	404.55090	209
1389563	201.28252	251	1405030	404.55091	209
1395361	1604.10588	227	1405031	404.55092	209
1395361	1604.10588	247	1405032	404.55089	209
1395361	1604.10588	258	1405230	904.55181	211
1396936	1104.99053	246	1405231	904.55180	211
1396936	1104.99053	257	1405233	704.55101	210
1396937	1104.99052	246	1405241	1004.55000	211
1396937	1104.99052	257	1405241	1004.55000	218
1398284	1104.99051	246	1405243	304.55031	209
1398284	1104.99051	257	1405244	304.55030	209
1398284	1104.99055	257	1405247	204.55021	209
1398284	1104.99057	257	1405247	204.55021	214
1398285	1104.99050	246	1405250	204.55020	209
1398285	1104.99050	257	1405250	204.55020	214
1398285	1104.99054	257	1405262	304.55031	209
1398285	1104.99058	257	1405263	304.55030	209
1399185	1004.10024	225	1405295	501.53500	210
1399833	1004.10025	225	1405766	404.55090	209
1400004	104.00004	240	1405767	404.55089	209
1400011	904.00011	244	1405880	404.55091	209
1400011	904.00011	255	1405881	404.55092	209
1400012	904.00012	244	1405990	304.55031	209
1400012	904.00012	255	1405991	304.55030	209
1400013	904.00013	244	1406622	1701.53600	212
1400013	904.00013	255	1406623	1704.55701	212
1400014	904.00014	244	1406624	1704.55700	212
1400014	904.00014	255	1406665	1904.55551	212
1400501	104.55010	208	1406665	1904.55551	216
1400502	404.55094	209	1406665	1904.55551	219
1400503	404.55093	209	1406666	1904.55550	212
1400504	1104.55061	211	1406666	1904.55550	216
1400505	1104.55060	211	1406666	1904.55550	219
1400506	104.55009	208	1407256	1701.53601	212
1400636	204.55022	209	1407464	1104.55060	211
1400637	204.55023	209	1407465	1104.55061	211
1400705	2404.55100	212	1408227	204.55021	209
1400710	904.55181	211	1408227	204.55021	214
1400711	904.55180	211	1408232	204.55020	209
1400753	1904.55551	212	1408232	204.55020	214
1400753	1904.55551	216	1409962	501.30418	209



1425124	504.10545	254	1629036	1004.00015	245
1425577	1104.99056	246	1629045	1004.00017	246
1425577	1104.99056	257	1629046	1004.00016	245
1427140	404.27140	242	1634640	404.10538	252
1435754	1104.63377	226	1634640	404.10539	253
1435755	1104.63378	226	1634640	404.10540	253
1436683	1604.10587	247	1635802	104.10501	251
1436684	1604.10586	247	1636911	1604.10590	227
1437809	204.37809	222	1636911	1604.10590	247
1437810	204.37810	222	1636911	1604.10590	258
1438576	1004.10027	226	1638480	1004.10021	225
1438577	1004.10026	226	1638481	1004.10020	225
1439348	1104.99053	246	1640320	104.72536	222
1439348	1104.99053	257	1641630	1004.10551	255
1439349	1104.99052	246	1641631	1004.10550	255
1439349	1104.99052	257	1641742	1604.10581	227
1440242	304.64797	223	1641742	1604.10581	247
1440243	304.64796	223	1641742	1604.10581	258
1440244	304.64101	223	1641743	1604.10580	227
1440245	304.64100	223	1641743	1604.10580	247
1445563	1004.00009	245	1641743	1604.10580	258
1445564	1004.00008	245	1642682	304.10511	252
1449528	1604.10587	247	1642683	304.10510	252
1449529	1604.10586	247	1644303	504.10540	254
1450155	1404.95611	226	1644323	504.10536	254
1450156	1404.95612	226	1644324	504.10537	254
1450976	1004.00005	244	1644325	504.10534	253
1450977	1004.00004	244	1644326	504.10535	254
1451482	1501.03100	213	1649363	1104.10517	256
1451482	1501.03100	229	1649363	1104.10519	256
1526649	501.30418	209	1649363	1104.10521	256
1603386	1004.10555	226	1649364	1104.10516	256
1603386	1004.10555	246	1649364	1104.10518	256
1603386	1004.10555	256	1649364	1104.10520	256
1605932	1004.00009	245	1649588	1006.33602	221
1605933	1004.00008	245	1649588	1006.33602	226
1607794	2104.95080	248	1649588	1006.33602	238
1608352	1601.50013	211	1649588	1006.33602	246
1608352	1601.50013	227	1649588	1006.33602	256
1610182	501.89373	224	1649918	3004.00000	229
1610182	501.89373	243	1650329	1104.99056	246
1610184	504.99027	224	1650329	1104.99056	257
1610184	504.99027	243	1651597	704.10502	243
1610187	504.99028	225	1651597	704.10502	255
1610187	504.99028	243	1651601	2404.10500	249
1610190	504.99026	224	1651601	2404.10500	259
1610190	504.99026	243	1651634	1704.63701	221
1610191	501.89373	224	1651634	1704.63701	228
1610191	501.89373	243	1651635	1704.63700	221
1610454	1004.00012	245	1651635	1704.63700	228
1614021	504.72500	224	1653605	003003	227
1614022	504.10545	254	1656562	404.63375	223
1617040	1704.63701	221	1656563	404.63375	223
1617040	1704.63701	228	1656911	204.91173	241
1617041	1704.63700	221	1656912	204.91172	241
1617041	1704.63700	228	1656917	204.37809	222
1625985	006130	249	1656918	204.37810	222
1625985	1504.10501	250	1656923	204.91173	241
1625986	006120	249	1656924	204.91172	241
1625986	1504.10500	250	1656977	204.37810	222
1626101	1604.55001	212	1657685	104.72536	222
1626102	1601.50015	211	1658382	1104.63374	226
1627643	1004.10025	225	1658383	1104.63377	226
1627646	1004.10024	225	1658384	1104.63378	226

ALL ITEMS MENTIONED IN OUR CATALOGUE ARE NOT ORIGINAL PARTS BUT PERFECTLY INTERCHANGEABLE WITH THEM.

GOVERNING LEGISLATIONS FOR THE SALE OF OUR PRODUCTS DIFFER IN EACH COUNTRY.

INFRINGEMENTS, IF ANY, OF LOCAL LEGISLATIONS ARE RESPONSIBILITY OF THE RETAILER IN THE COUNTRY OF FINAL DISTRIBUTION.



1658401	804.10593	255	1699300	1604.10581	227
1659248	504.10534	253	1699300	1604.10581	247
1659249	504.10535	254	1699300	1604.10581	258
1659253	204.69437	222	1699301	1604.10580	227
1659253	204.69437	240	1699301	1604.10580	247
1659254	204.69438	222	1699301	1604.10580	258
1659254	204.69438	240	1699472	1004.10027	226
1659811	204.28936	241	1699473	1004.10026	226
1659811	204.28936	252	1699932	1604.10589	227
1659811	204.28937	241	1699932	1604.10589	247
1659811	204.28937	252	1699932	1604.10589	258
1660859	2104.85080	228	1699933	1604.10590	227
1660960	1604.10585	258	1699933	1604.10590	247
1660961	1604.10584	258	1699933	1604.10590	258
1660962	1604.72501	227	1700265	501.31507	210
1660963	1604.72500	227	1700265	501.31507	215
1662370	1004.10552	256	1700265	501.31507	218
1667520	1004.10553	256	1700269	501.31508	210
1667521	1004.10554	256	1700269	501.31508	215
1667885	1004.10019	225	1700269	501.31508	218
1670877	504.99028	225	1700303	501.31505	210
1670877	504.99028	243	1700303	501.31505	215
1672846	804.10598	255	1700303	501.31505	218
1674548	1004.10552	256	1700306	501.31506	210
1676218	1404.95621	247	1700306	501.31506	215
1676218	1404.95621	257	1700306	501.31506	218
1676219	1404.95622	247	1700387	104.55008	208
1676219	1404.95622	257	1700801	104.55012	208
1683721	1104.10521	256	1700802	104.55008	208
1683722	1104.10516	256	1700877	404.55092	209
1683722	1104.10517	256	1701039	204.55023	209
1683722	1104.10518	256	1701040	204.55022	209
1683722	1104.10519	256	1701375	104.55012	208
1683722	1104.10520	256	1704604	501.31506	210
1684038	504.10543	254	1704604	501.31506	215
1684042	504.10542	254	1704604	501.31506	218
1684046	504.10544	254	1704605	501.31508	210
1684676	804.10599	255	1704605	501.31508	215
1684871	1104.10523	256	1704605	501.31508	218
1684872	1104.10522	256	1705698	1904.55551	212
1685324	504.10539	254	1705698	1904.55551	216
1685325	504.10538	254	1705698	1904.55551	219
1685330	504.10532	253	1705699	1904.55550	212
1685330	504.10532	264	1705699	1904.55550	216
1685331	504.10533	253	1705699	1904.55550	219
1689347	504.10531	224	1706904	404.56100	214
1689347	504.10531	232	1706904	404.56100	217
1689347	504.10531	253	1706919	904.56171	215
1689348	504.10530	224	1706919	904.56171	218
1689348	504.10530	232	1706920	904.56170	215
1689348	504.10530	253	1706920	904.56170	218
1689348	504.10530	264	1706953	104.56012	214
1693114	1004.10019	225	1706968	104.56011	217
1693664	1004.10553	256	1706969	104.56011	217
1693665	1004.10554	256	1706972	404.56099	214
1695109	1104.10523	256	1706972	404.56099	217
1695110	1104.10522	256	1706973	404.56100	214
1695228	304.64799	223	1706973	404.56100	217
1695229	304.64798	223	1706976	404.56099	214
1695234	304.10511	252	1706976	404.56099	217
1695235	304.10510	252	1706984	1104.56031	216
1696660	1004.10027	226	1706984	1104.56031	218
1696662	1004.10027	226	1706985	1104.56030	216
1696663	1004.10026	226	1706985	1104.56030	218



1706986	404.56101	215	1738627	1104.99058	257
1706986	404.56101	217	1742638	704.55100	210
1706987	404.56102	215	1742640	704.55101	210
1706987	404.56102	217	1743684	1604.10581	227
1706996	1604.56605	216	1743684	1604.10581	247
1706996	1604.56605	219	1743684	1604.10581	258
1706997	1604.56604	216	1743685	1604.10580	227
1706997	1604.56604	219	1743685	1604.10580	247
1707002	1104.56032	216	1743685	1604.10580	258
1707003	1104.56033	216	1743690	1604.10589	227
1707006	304.56050	217	1743690	1604.10589	247
1707007	304.56051	217	1743690	1604.10589	258
1707123	104.56010	214	1743691	1604.10590	227
1707356	1904.55551	212	1743691	1604.10590	247
1707356	1904.55551	216	1743691	1604.10590	258
1707356	1904.55551	219	1745335	1004.10555	226
1707357	1904.55550	212	1745335	1004.10555	246
1707357	1904.55550	216	1745335	1004.10555	256
1707357	1904.55550	219	1747244	104.72534	222
1707973	304.56050	217	1779721	1904.95655	259
1708932	304.56051	217	1779722	1904.95654	259
1709693	904.56171	215	1779727	1904.72755	228
1709693	904.56171	218	1779728	1904.72754	228
1709694	904.56170	215	1781902	504.10541	254
1709694	904.56170	218	1796244	304.10517	252
1714558	1604.56605	216	1796245	304.10516	252
1714558	1604.56605	219	1796324	501.53501	210
1714559	1604.56604	216	1796324	501.53501	224
1714559	1604.56604	219	1796324	501.53501	242
1714809	1904.55551	212	1798448	1104.10615	266
1714809	1904.55551	216	1798449	1104.10614	266
1714809	1904.55551	219	1798457	1104.10617	266
1714810	1904.55550	212	1798458	1104.10616	266
1714810	1904.55550	216	1798459	1004.10653	266
1714810	1904.55550	219	1798460	1004.10652	266
1725270	1604.10585	258	1798461	304.10611	263
1725271	1604.10584	258	1798461	304.10615	263
1725272	1604.72501	227	1798462	304.10610	263
1725273	1604.72500	227	1798462	304.10614	263
1732653	1004.10555	226	1798463	1004.10651	266
1732653	1004.10555	246	1798464	1004.10650	266
1732653	1004.10555	256	1798471	1104.10621	267
1733892	501.31511	210	1798471	1104.10627	267
1733892	501.31511	215	1798472	1104.10620	267
1733892	501.31511	218	1798472	1104.10626	267
1733893	501.31512	210	1798782	804.10598	255
1733893	501.31512	215	1805712	501.53500	210
1733893	501.31512	218	1808561	504.10541	254
1735355	1604.10588	227	1809265	204.91173	241
1735355	1604.10588	247	1809266	204.91172	241
1735355	1604.10588	258	1812862	504.10530	224
1736953	501.31510	210	1812862	504.10530	232
1736953	501.31510	215	1812862	504.10530	253
1736953	501.31510	218	1812862	504.10530	264
1736954	501.31509	210	1812867	504.10539	254
1736954	501.31509	215	1814096	1604.10588	227
1736954	501.31509	218	1814096	1604.10588	247
1738626	1104.99051	246	1814096	1604.10588	258
1738626	1104.99051	257	1816910	504.10543	254
1738626	1104.99055	257	1816912	504.10542	254
1738626	1104.99057	257	1816914	504.10544	254
1738627	1104.99050	246	1817860	504.10531	224
1738627	1104.99050	257	1817860	504.10531	232
1738627	1104.99054	257	1817860	504.10531	253

ALL ITEMS MENTIONED IN OUR CATALOGUE ARE NOT ORIGINAL PARTS BUT PERFECTLY INTERCHANGEABLE WITH THEM.

GOVERNING LEGISLATIONS FOR THE SALE OF OUR PRODUCTS DIFFER IN EACH COUNTRY.

INFRINGEMENTS, IF ANY, OF LOCAL LEGISLATIONS ARE RESPONSIBILITY OF THE RETAILER IN THE COUNTRY OF FINAL DISTRIBUTION.



1825005	404.63375	223	1861672	204.10621	262
1825008	404.10540	253	1861673	204.10620	262
1825434	404.10692	264	1861949	1104.10619	267
1826225	404.10538	252	1861949	1104.10629	267
1826225	404.10539	253	1861950	1104.10618	267
1826225	404.10540	253	1861950	1104.10628	267
1826226	404.63375	223	1861983	404.10692	264
1826510	404.10691	264	1862945	1104.99053	246
1828855	304.10613	263	1862945	1104.99053	257
1828855	304.10617	263	1862946	1104.99052	246
1828856	304.10612	263	1862946	1104.99052	257
1828856	304.10616	263	1869588	404.10690	263
1830562	504.10538	254	1869588	404.10693	264
1835023	204.10621	262	1871493	2104.85080	228
1835024	204.10620	262	1872760	1704.10601	268
1835027	204.10623	263	1872761	1704.10600	268
1835028	204.10622	263	1875549	204.10533	231
1835031	204.10625	263	1875549	204.10533	262
1835032	204.10624	263	1875550	204.10534	231
1835065	204.10626	263	1875550	204.10534	262
1835066	204.10627	263	1875551	204.10529	230
1835170	1404.10671	267	1875551	204.10529	261
1835170	1404.10673	268	1875551	204.10530	231
1835171	1404.10670	267	1875551	204.10530	262
1835171	1404.10672	268	1875552	204.10529	230
1835709	904.10681	265	1875552	204.10529	261
1835710	904.10680	265	1875552	204.10530	231
1835710	904.10682	265	1875552	204.10530	262
1835710	904.10683	265	1875553	204.10531	231
1835763	904.10681	265	1875553	204.10531	262
1835764	904.10680	265	1875554	204.10532	231
1835874	1604.10601	233	1875554	204.10532	262
1835874	1604.10601	268	1875563	204.10531	231
1835875	1604.10600	233	1875563	204.10531	262
1835875	1604.10600	268	1875564	204.10532	231
1835886	1604.10603	268	1875564	204.10532	262
1835887	1604.10602	268	1875567	204.10535	231
1836304	304.10517	252	1875567	204.10535	262
1836305	304.10516	252	1875576	1504.10600	234
1836599	1404.95611	226	1875576	1504.10600	269
1836600	1404.95612	226	1875577	1504.10601	234
1837641	1104.64609	233	1875577	1504.10601	269
1837642	1104.64608	233	1875578	1504.10602	234
1837654	1104.64605	232	1875578	1504.10602	269
1837655	1104.64604	232	1875579	1504.10604	234
1843492	204.10623	263	1875579	1504.10604	269
1843493	204.10622	263	1875580	1504.10603	234
1844275	904.64081	232	1875580	1504.10603	269
1844276	904.64080	232	1875581	1504.10606	235
1846491	1604.10605	233	1875581	1504.10606	269
1846491	1604.10605	268	1876631	404.64090	232
1846492	1604.10604	233	1877261	104.64101	230
1846492	1604.10604	268	1879827	1704.63702	221
1848557	1104.64603	233	1879827	1704.63702	228
1848558	1104.64602	233	1880378	1104.10621	267
1852685	404.63375	223	1880378	1104.10627	267
1857526	1604.10607	233	1880379	1104.10620	267
1857526	1604.10607	268	1880379	1104.10626	267
1857527	1604.10606	233	1880397	1104.10623	267
1857527	1604.10606	268	1880398	1104.10622	267
1857653	104.10601	230	1881344	304.64201	231
1857653	104.10601	261	1881345	304.64200	231
1857654	104.10602	230	1881346	304.64203	232
1857654	104.10602	261	1881347	304.64202	232



1881350	1104.64601	233	1922985	1004.10655	232
1881351	1104.64600	233	1922985	1004.10655	266
1886591	104.10600	261	1922986	1004.10654	232
1886592	104.64100	230	1922986	1004.10654	266
1887134	1104.64607	233	1927847	204.10529	230
1887135	1104.64606	233	1927847	204.10529	261
1887709	104.10604	261	1927847	1004.10530	269
1892197	204.10531	231	1933253	404.64090	232
1892197	204.10531	262	1936285	104.10604	261
1892198	204.10532	231	1936302	204.10540	231
1892198	204.10532	262	1936302	204.10540	262
1892245	204.10537	231	1936302 Antispray	204.10531	231
1892245	204.10537	262	1936302 Antispray	204.10531	262
1892246	204.10536	231	1936302 Antispray	204.10532	231
1892246	204.10536	262	1936302 Antispray	204.10532	262
1892248	204.10541	231	1940334	504.10638	264
1892248	204.10541	262	1940335	504.10639	264
1892911	1604.56601	216	1940341	504.10630	232
1892911	1604.56601	219	1940341	504.10630	264
1892911	1604.56601	233	1940342	504.10631	264
1892912	1604.56600	216	1940527	1404.95612	226
1892912	1604.56600	219	1945871	1004.10651	266
1892912	1604.56600	233	1945872	1004.10650	266
1892913	1604.56603	216	1945944	1004.10622	266
1892913	1604.56603	219	1945945	1004.10621	266
1892913	1604.56603	234	1945946	1004.10620	266
1892914	1604.56602	216	1948151	1004.10653	266
1892914	1604.56602	219	1948152	1004.10652	266
1892914	1604.56602	234	1948243	304.10611	263
1893585	1004.10559	265	1948243	304.10615	263
1893586	1004.10558	265	1948244	304.10610	263
1893901	204.37809	222	1948244	304.10614	263
1893902	204.37810	222	1949304	504.72500	224
1893917	104.64102	230	1949305	504.10545	254
1895877	1004.10655	232	1952141	504.63501	224
1895877	1004.10655	266	1952146	504.63500	224
1895878	1004.10654	232	1952791	304.64201	231
1895878	1004.10654	266	1952792	304.64200	231
1911154	304.64799	223	1953385	404.10690	263
1911155	304.64798	223	1953385	404.10693	264
1911162	1104.99049	246	1954514	104.10501	251
1911163	1104.99048	246	1956193	104.64101	230
1914690	1504.10681	234	1973239	003092	234
1914690	1504.10681	234	1973239	003092	269
1914690	1504.10681	269	1973359	1104.10517	256
1914690	1504.10681	269	1973359	1104.10519	256
1914691	1504.10680	234	1973359	1104.10521	256
1914691	1504.10680	234	1973360	1104.10516	256
1914691	1504.10680	234	1973360	1104.10518	256
1914691	1504.10680	235	1973360	1104.10520	256
1914691	1504.10680	269	2011376	1104.10617	266
1914691	1504.10680	269	2011377	1104.10616	266
1914691	1504.10680	269	2013729	1704.10567	238
1914691	1504.10680	269	2013729	1704.10567	248
1918141	1904.95649	248	2013729	1704.10567	258
1918141	1904.95649	258	2013729	1704.10567	268
1918142	1904.95648	248	2013730	1704.10566	238
1918142	1904.95648	258	2013730	1704.10566	248
1918143	1904.72753	228	2013730	1704.10566	258
1918144	1904.72752	228	2013730	1704.10566	268
1918145	1904.95653	259	2032703	1604.10603	268
1918146	1904.95652	259	2032704	1604.10602	268
1922030	1104.10617	266	2032705	1604.56601	216
1922031	1104.10616	266	2032705	1604.56601	219

ALL ITEMS MENTIONED IN OUR CATALOGUE ARE NOT ORIGINAL PARTS BUT PERFECTLY INTERCHANGEABLE WITH THEM.

GOVERNING LEGISLATIONS FOR THE SALE OF OUR PRODUCTS DIFFER IN EACH COUNTRY.

INFRINGEMENTS, IF ANY, OF LOCAL LEGISLATIONS ARE RESPONSIBILITY OF THE RETAILER IN THE COUNTRY OF FINAL DISTRIBUTION.



2032705	1604.56601	233
2032706	1604.56600	216
2032706	1604.56600	219
2032706	1604.56600	233
2032707	1604.56603	216
2032707	1604.56603	219
2032707	1604.56603	234
2032708	1604.56602	216
2032708	1604.56602	219
2032708	1604.56602	234
2033875	1104.10625	267
2033875	1104.10631	267
2033876	1104.10624	267
2033876	1104.10630	267
2041669	1404.10671	267
2041669	1404.10673	268
2041670	1404.10670	267
2041670	1404.10672	268
2046358	1404.10671	267
2046358	1404.10673	268
2046359	1404.10670	267
2046359	1404.10672	268
2046502	104.10600	261
2046503	104.64100	230
2048272	104.10600	261
2050044	1004.00011	245
2104217	104.10603	261
2107372	1104.10613	266
2107373	1104.10612	266
2114704	904.10681	265
2114705	904.10680	265
2114705	904.10682	265
2114705	904.10683	265
2120351	204.10531	231
2120351	204.10531	262
2120352	204.10532	231
2120352	204.10532	262
2120359	204.10531	231
2120359	204.10531	262
2120360	204.10532	231
2120360	204.10532	262
2120361	204.10531	231
2120361	204.10531	262
2120362	204.10532	231
2120362	204.10532	262
2130640	1904.72753	228
2130641	1904.72752	228
2130642	1904.95653	259
2130643	1904.95652	259
2144204	104.64102	230
2148561	1904.72755	228
2148562	1904.72754	228
2148573	1904.95655	259
2148574	1904.95654	259
280059	104.80059	236
280062	904.80062	238
280062	904.80062	244
280063	904.80063	238
280063	904.80063	244
964275	404.56103	215
964275	404.56103	218

COS.ME

SIMILAR ref.	COS.PEL ref.	PAG
-	003120	278
-	003120	280
-	003123	307
-	003123	317
-	003123	326
-	003123	335
-	005561	307
-	005562	307
-	005590	307
-	005600	307
-	009122	274
-	009612	336
-	011113	307
-	011191	307
-	011201	307
-	205.94312	308
-	205.94312	318
-	505.12100	312
-	505.12101	312
-	505.12102	312
-	505.12103	312
-	505.94306	322
-	505.94307	322
-	505.94308	322
-	505.94309	322
-	505.94326	323
-	905.94162	304
-	905.94163	304
-	1005.96003	335
-	1500.00000	307
-	1500.00000	317
-	1500.00000	326
-	1500.00000	336
-	1500.00001	307
-	1500.00001	317
-	1500.00001	326
-	1500.00001	336
-	1605.92602	277
-	1605.92603	277
-	1605.92606	277
-	1605.92607	277
-	1605.94067	298
-	2000.00013	273
-	2000.00014	307
-	3005.00000	335
-	3005.00001	317
-	3005.00001	326
-	3005.00002	287
-	3005.00002	299
-	3005.00003	307
0007200079	1905.94001	326
0007200179	1905.94000	326
0007601359	1705.97310	273
0007601359	1705.97310	287
0008102079	505.97351	283
0008102079	505.97351	295
0008102179	505.97350	283
0008102179	505.97350	295
0008102479	505.97354	284



0008102479	505.97354	296	6736600301	305.67320	281
0008109016	505.12106	313	6738800170	405.67300	281
0008200777	1605.94064	298	9013100722	405.91671	273
0008264610	1605.94368	326	9016306907	205.91101	272
0008264710	1605.94369	326	9016307007	205.91100	272
0015402670	005630	289	9016710020	1805.91094	273
0015402770	005640	289	9016710220	1805.91094	273
0018109116	505.12107	313	9017201146	1905.91501	273
0018109216	505.12109	313	9017201246	1905.91500	273
0018112033	505.12033	303	9017500202	105.91202	272
0018112233	505.12233	303	9018800103	105.91201	272
0018116033	505.12110	313	9018800385	105.91200	272
0018229020 + 00082012771605.92610		277	9018800670	405.91670	272
0018229320 + 00082012771605.92611		277	9018800870	405.91670	272
0028100816	505.12232	303	9066200024	105.92103	275
0028102416	505.94321	323	9068101893	505.92501	276
0028102516	505.94320	323	9068101993	505.92500	276
0028102616	505.94317	323	9068102293	505.92505	276
0028102716	505.94316	323	9068102393	505.92504	276
0028103214	505.94323	323	9068102693	505.92509	276
0028103314	505.94322	323	9068102793	505.92508	276
0028106016	505.12231	283	9068104816	505.92501	276
0028106016	505.12231	303	9068104916	505.92500	276
0028110433	505.12108	313	9068105216	505.92505	276
0028111533	505.92513	277	9068105316	505.92504	276
0028111633	505.92512	277	9068105616	505.92509	276
0028111933	505.92515	277	9068105716	505.92508	276
0028112033	505.92514	277	9068106016	505.92503	276
0028113333	505.94313	323	9068106116	505.92502	276
0028113433	505.94312	323	9068106416	505.92507	276
0028113733	505.94315	323	9068106516	505.92506	276
0028113833	505.94314	323	9068106816	505.92511	277
0301081114	1605.94164	306	9068106916	505.92510	277
0301081119	1605.94165	306	9068202361	1605.93601	280
3755410103	1005.97302	285	9068202461	1605.93600	280
5007501602	105.64102	288	9068204061	1605.93603	280
6417200346	1905.64100	289	9068204161	1605.93602	280
6417201171	1405.64151	289	9068800003	105.92102	275
6417201271	1405.64150	289	9068800257	105.93100	279
6417500002	105.64102	288	9068800403	105.93101	279
6417501009	105.64101	288	90688015709B51	405.93400	279
6418104216	505.64110	289	90688017709B51	405.93401	280
6418104216	505.64110	291	9068810101	205.93201	279
6418104616	505.64111	289	9068810201	205.93200	279
6418104616	505.64111	291	9068880051	105.93102	279
6418104716	505.64112	289	9100002004	2105.94180	316
6418104716	505.64112	291	9305200007	205.20006	308
6418800236	405.00236	289	9305200007	205.20007	292
6418800270	405.00270	288	9305200007	205.20007	309
6418800473	405.00472	289	9305200019	205.20011	293
6418800473	405.00472	291	9305200019	205.20011	309
6418809970	405.00471	289	9305200019	205.20011	319
6418809970	405.00471	291	9305200020	205.20013	309
6418810201	205.10201	288	9305200020	205.20013	319
6418810301	205.10300	288	9305200107	205.20012	309
6497500118	105.64900	290	9305200107	205.20012	319
6498800070	405.00070	291	9305200107	205.20015	309
6498800136	405.00136	291	9305200107	205.20015	319
6498800736	405.64988	291	9305200119	205.20010	293
6498810001	205.10101	290	9305200119	205.20010	309
6498810101	205.10100	290	9305200119	205.20010	319
6625200019	201.32440	290	9305200120	205.20014	293
6625200019	201.32441	290	9305200120	205.20014	309
6736600201	305.67321	281	9305200120	205.20014	319

ALL ITEMS MENTIONED IN OUR CATALOGUE ARE NOT ORIGINAL PARTS BUT PERFECTLY INTERCHANGEABLE WITH THEM.

GOVERNING LEGISLATIONS FOR THE SALE OF OUR PRODUCTS DIFFER IN EACH COUNTRY.

INFRINGEMENTS, IF ANY, OF LOCAL LEGISLATIONS ARE RESPONSIBILITY OF THE RETAILER IN THE COUNTRY OF FINAL DISTRIBUTION.



9305200207	205.20008	292	9416661901	305.94105	301
9305200207	205.20008	309	9416661901	305.94105	310
9305200207	205.20008	318	9416661901	305.94105	319
9305200207	205.20009	309	9416662001	305.94104	301
9305200207	205.20009	318	9416662001	305.94104	310
9305200820	205.20014	293	9416662001	305.94104	319
9305200820	205.20014	309	9416662101	305.94107	301
9305200820	205.20014	319	9416662101	305.94107	319
9406600101	305.94005	293	9416662201	305.94106	301
9406600201	305.94004	293	9416662201	305.94106	319
9406601101	305.94007	293	9416663328	1005.94305	305
9406601201	305.94006	293	9416663328	1005.94305	325
9406601830	1005.94003	297	9416663428	1005.94300	305
9406601930	1005.94002	297	9416663428	1005.94300	324
9406604701	305.94005	293	9416663528	1005.94304	305
9406604801	305.94004	293	9416663528	1005.94304	325
9406660005-7C72	305.94010	293	9416663728	1005.94303	305
9406660101	305.94005	293	9416663728	1005.94303	325
9406660128	1005.94001	297	9416663828	1005.94302	305
9406660128	1005.94001	324	9416663828	1005.94302	325
9406660201	305.94004	293	9417200037	1705.94351	316
9406660428	1005.94000	297	9417200348	1405.94105	325
9406660428	1005.94000	324	9417200448	1405.94104	325
9406660501	305.94007	293	9417200837	1705.94352	316
9406660601	305.94006	293	9417230120	1705.94350	316
9406662401	305.94003	293	9417280856	1405.94103	325
9406662501	305.94002	293	9417280956	1405.94102	325
9408105516	505.94010	283	9417500009	105.11219	300
9408105516	505.94010	295	9418100010	705.94120	303
9408107316	505.94324	283	9418102116	505.94327	283
9408107316	505.94324	295	9418102116	505.94327	295
9408200056	1605.94065	298	9418102116	505.94327	303
9408200156	1605.94066	298	9418102116	505.94327	313
9408200161	1605.94061	298	9418102116	505.94327	323
9408200221	1605.94064	298	9418110010	705.94121	303
9408200261	1605.94060	298	9418110610	705.94121	303
9408200321	1605.94063	297	9418201321	1605.94166	305
9408200421	1605.94062	297	9418202561	1605.94161	306
9408812901-7354	205.94084	292	9418202661	1605.94160	306
9408850122	405.94023	294	9418205161	1605.94161	306
9408850125	405.94013	295	9418205261	1605.94160	306
9408850225	405.94014	295	9418205361	1605.94165	306
9408850322	405.94025	294	9418205461	1605.94164	306
9408850422	405.94024	294	9418800225	405.94108	302
9408900525-7354	205.94081	292	9418800325	405.94109	303
9408900625-7354	205.94080	292	9418800344	905.94161	304
9415200320	205.20001	300	9418800444	905.94160	304
9415201620	205.20000	300	9418800970	405.94101	301
9415220004	205.20004	301	9418801070	405.94100	301
9415220004	205.20005	301	9418802370	405.94103	302
9415220067	1001.23641	306	9418802470	405.94104	302
9415220167	201.32440	290	9418802770	405.94105	302
9415220167	205.20005	301	9418802870	405.94106	302
9415220167	205.20006	308	9418811501	205.94101	300
9415220167	1005.00003	306	9418811601	205.94100	300
9415240029	205.19999	300	9418840222	905.84123	304
9415240129	205.19998	300	9418840322	905.84122	304
9415410103	1005.00002	304	9418840422	905.84125	304
9416600001	305.94101	301	9418840522	905.84124	304
9416600101	305.94100	301	9418840622	905.94165	304
9416600201	305.94101	301	9418840722	905.94164	304
9416600301	305.94100	301	9418841122	905.84129	304
9416600401	305.94103	301	9418841222	905.84128	304
9416600501	305.94102	301	9418841422	905.84127	304



9418841522	905.84126	304	9438110307	505.94319	323
9418850825-7C72	405.94111	302	9438110407	505.94318	323
9418850922	405.94110	295	9438111010	705.94308	314
9418850922	405.94110	302	9438111210	705.94310	314
9418850925-7C72	405.94112	302	9438200056	1605.94363	316
9418851301	405.94107	302	9438200156	1605.94362	316
9418851401	405.94102	294	9438200161	1605.94361	316
9418851401	405.94102	301	9438200261	1605.94360	316
9418853422	405.94115	302	9438200361	1605.94359	316
9418853522	405.94114	302	9438200461	1605.94358	316
9418853822	405.94113	302	9438202261	1605.94355	315
9436600128	305.94354	311	9438202361	1605.94354	315
9436600228	305.94353	310	9438260259	1605.94371	316
9436600601	305.94345	310	9438260359	1605.94370	316
9436600601	305.94345	319	9438800004	405.94377	311
9436600701	305.94344	310	9438800004	405.94377	321
9436600701	305.94344	319	9438800073	405.94361	311
9436600801	305.94349	310	9438800073	405.94361	320
9436600801	305.94349	320	9438800104	405.94376	311
9436600901	305.94348	310	9438800104	405.94376	321
9436600901	305.94348	320	9438800173	405.94360	311
9436601001	305.94341	310	9438800173	405.94360	320
9436601101	305.94340	310	9438800270	405.94359	311
9436660005	305.94352	310	9438800270	405.94359	320
9436660005	305.94352	320	9438800306	205.94311	308
9436660028	1005.94301	314	9438800370	405.94358	311
9436660178	1005.94317	315	9438800370	405.94358	320
9436660278	1005.94316	315	9438800406	205.94310	308
9436660401	305.94107	301	9438804373	405.94368	311
9436660401	305.94107	319	9438804373	405.94368	320
9436660478	1005.94313	315	9438804473	405.94377	311
9436660501	305.94106	301	9438804473	405.94377	321
9436660501	305.94106	319	9438804573	405.94376	311
9436660578	1005.94312	315	9438804573	405.94376	321
9436660637	305.94339	310	9438804872-7354	405.94393	321
9436660678	1005.94315	315	9438804972-7354	405.94394	321
9436660737	305.94338	310	9438806072-7354	405.94395	321
9436660778	1005.94314	315	9438806172-7354	405.94396	321
9436660801	305.94351	320	9438807270	405.94376	311
9436660901	305.94350	320	9438807270	405.94376	321
9436660931	1005.94307	315	9438807370	405.94377	311
9436661031	1005.94308	315	9438807370	405.94377	321
9436663801	305.94105	301	9438807470	405.94368	311
9436663801	305.94105	310	9438807470	405.94368	320
9436663801	305.94105	319	9438807570	405.94369	311
9436663901	305.94104	301	9438807570	405.94369	320
9436663901	305.94104	310	9438809870	405.94368	311
9436663901	305.94104	319	9438809870	405.94368	320
9436664201	305.94107	301	9438809872	405.94359	311
9436664201	305.94107	319	9438809872	405.94359	320
9436664301	305.94106	301	9438809972	405.94358	311
9436664301	305.94106	319	9438809972	405.94358	320
9437500009	105.94300	308	9438810011	1005.94306	315
9437500518	105.94302	308	9438840023	905.94371	314
9437501418	105.94304	318	9438840060	405.94381	322
9437501518	105.94303	318	9438840074	405.94371	312
9438100410	705.94313	324	9438840123	905.94370	314
9438100610	705.94312	324	9438840160	405.94380	322
9438104716	505.12104	313	9438840174	405.94372	312
9438105116	505.94325	313	9438840223	905.94373	314
9438105816	505.94311	322	9438840323	905.94372	314
9438106016	505.94310	322	9438840623	905.94375	314
9438110010	705.94309	314	9438840723	905.94374	314
9438110210	705.94311	314	9438841722	905.94377	324

ALL ITEMS MENTIONED IN OUR CATALOGUE ARE NOT ORIGINAL PARTS BUT PERFECTLY INTERCHANGEABLE WITH THEM.

GOVERNING LEGISLATIONS FOR THE SALE OF OUR PRODUCTS DIFFER IN EACH COUNTRY.

INFRINGEMENTS, IF ANY, OF LOCAL LEGISLATIONS ARE RESPONSIBILITY OF THE RETAILER IN THE COUNTRY OF FINAL DISTRIBUTION.



9438841822	905.94376	324	9606662228	305.96204	329
9438841922	905.94379	324	9607200901-7277	1405.96101	334
9438842022	905.94378	324	9607201001-7277	1405.96100	334
9438850063	405.94379	322	9607201101-7277	1405.96103	334
9438850074	405.94397	312	9607201201-7277	1405.96102	334
9438850163	405.94378	322	9607230609	1705.96101	335
9438850174	405.94398	312	9607230709	1705.96100	335
9438850301	405.94370	311	9607510430	905.96181	333
9438850301	405.94370	321	9607510530	905.96182	333
9438850325	405.94365	312	9607510630	905.96173	333
9438850374	405.94373	312	9607510730	905.96174	333
9438850422	405.94375	312	9607511030	905.96179	333
9438850425	405.94366	312	9607511130	905.96180	333
9438850522	405.94374	312	9607511230	905.96171	333
9438850525	405.94367	312	9607511330	905.96172	333
9438851122	405.94392	322	9608103316	505.96503	331
9438851125	405.94385	321	9608103416	505.96502	331
9438851225	405.94386	321	9608103516	505.96501	331
9438851325	405.94387	321	9608104316	505.96502	331
9438851422	405.94389	322	9608104716	505.96500	331
9438851522	405.94388	322	9608110010	705.96902	332
9438851625	405.94383	321	9608110607	505.96507	331
9438851725	405.94382	321	9608110707	505.96506	331
9438851825	405.94384	321	9608111007	505.96505	331
9438853414	1005.94319	315	9608111107	505.96504	331
9438853514	1005.94318	315	9608111407	505.96509	332
9445220167	201.32440	290	9608111507	505.96508	332
9445220167	205.20005	301	9608112210	705.96902	332
9445220167	1001.23641	306	9608200239	1605.96101	334
9446660101	305.94009	293	9608200339	1605.96100	334
9446660201	305.94008	293	9608200439	1605.96105	334
9446660301-7354	305.94011	294	9608200539	1605.96104	334
9446660401-7354	305.94012	294	9608200639	1605.96103	334
9446661301-7354	305.94001	293	9608200739	1605.96102	334
9446661401-7354	305.94000	293	9608201021	1605.96111	334
9448800104	405.94009	294	9608201121	1605.96110	334
9448800270	405.94011	294	9608801790-7G99	405.96103	330
9448800370	405.94010	294	9608802603	1105.96501	333
9448802404	405.94008	294	9608802703	1105.96500	333
9448812801-7354	205.94085	292	9608803303	1105.96503	333
9448840022	905.94091	297	9608803403	1105.96502	333
9448840122	905.94090	297	9608803905-9135	905.96175	333
9448840222	905.94093	297	9608804005-9135	905.96176	333
9448840322	905.94092	297	9608813403	205.96026	327
9448840422	905.94095	297	9608813503	205.96025	327
9448840522	905.94094	297	9608816803-7G99	205.96027	328
9448840722	905.94090	297	9608816903-7G99	205.96028	328
9448850125	405.94016	295	9608817102	205.96025	327
9448850525	405.94019	295	9608850438-7G99	405.96109	331
9448850574	405.94021	294	9608850438-9135	405.96107	331
9448850625	405.94018	295	9608850538-7G99	405.96110	331
9448850674	405.94022	294	9608850538-9135	405.96108	331
9448850725	405.94017	295	9608852584-9135	105.96153	327
9448850774	405.94020	294	9608852684-9135	105.96152	327
9605200019	205.96023	328	9608853674	405.96089	329
9605200067	205.96018	328	9608853774	405.96088	329
9605200067	205.96019	328	9608854925-7G99	405.96101	330
9605200067	1005.96001	335	9608855025-7G99	405.96102	330
9605200119	205.96024	328	9608857874	405.96087	329
9606661703-7277	305.96203	329	9608857974	405.96086	329
9606661703-9135	305.96207	329	9608859408-9135	905.96177	333
9606661903-7277	305.96202	329	9608859508-9135	905.96178	333
9606662103-7277	305.96202	329	9616661601-7277	305.96205	329
9606662103-9135	305.96208	329	9616661601-9135	305.96201	328



9616661801-7277	305.96206	329	A0025444790	011241	273
9616661801-9135	305.96200	328	A0025444790	011241	287
9618850053-9135	105.96154	327	A0025445403	005740	273
9618850153-9135	105.96151	327	A0025445503	005750	273
9618851453	105.96149	327	A0025447390	096300	335
9678200121	1605.97313	286	A0025447390	096300	336
9678200221	1605.97312	286	A0028106016	505.96519	324
9678201121	1605.97319	286	A0028106016	505.96519	332
9678201221	1605.97318	286	A0028110033	505.97357	284
9705253439	1005.97001	285	A0028110033	505.97357	296
9705253539	1005.97000	285	A0028114633	505.97358	284
9736661328	1005.97303	285	A0028114633	505.97358	296
9736661428	1005.97304	285	A0028114733	505.97359	284
9736661528	1005.97305	285	A0028114733	505.97359	296
9736661628	1005.97306	285	A0028116333	505.96511	332
9736663101	305.97343	282	A0028116433	505.96510	332
9736663201	305.97342	282	A0028116533	505.96513	332
9737200346	1905.97351	287	A0028116633	505.96512	332
9737200346	1905.97351	298	A0028208456	1605.94167	306
9737200446	1905.97350	287	A0028208556	1605.94168	306
9737200446	1905.97350	298	A0028208656	1605.94169	306
9738110410	705.97300	284	A0028208756	1605.94170	306
9738110510	705.94011	297	A0035441703	009611	335
9738110710	705.97301	285	A0035441803	009610	335
9738110810	705.94010	296	A0035445303	005790	287
9738200161	1605.97307	286	A0035445703	005780	287
9738200261	1605.97306	286	A008262056	1503.45103	278
9738200321	1605.97301	285	A008262056	1503.45103	280
9738200421	1605.97300	285	A008262156	1503.45102	278
9738200521	1605.97303	286	A008262156	1503.45102	280
9738200561	1605.97305	286	A2118200556	1605.92601	277
9738200621	1605.97302	286	A2118200656	1605.92600	277
9738200661	1605.97304	286	A6288800171	415.00105	338
9738202861	1605.97309	286	A6288802671	415.00100	337
9738202961	1605.97308	286	A6288850102	415.00107	338
9738840123	905.97311	285	A6288850202	415.00108	338
9738840223	905.97312	285	A6288850401	415.00090	337
A0005003049	2105.94181	316	A6288850505	415.00104	337
A0005003149	2105.94180	316	A6416201436	905.64990	291
A0005003449	2105.94181	316	A6416201536	905.64991	291
A0005003849	2105.94181	316	A6417500618	105.64100	288
A0005445411	003007	305	A6496600006	305.64931	290
A0008101579	505.97352	284	A6496600106	305.64930	290
A0008101579	505.97352	296	A9018201061	1605.91601	273
A0008101679	505.97355	284	A9018201161	1605.91600	273
A0008101679	505.97355	296	A9066200234	405.92192	276
A0008101879	505.97353	284	A9066377719	205.92201	275
A0008101879	505.97353	296	A9066377819	205.92200	275
A0008261556	009121	273	A9067500002	105.92100	275
A0008261656	009120	273	A9068200161	1605.92605	277
A0015401470	005630	289	A9068200164	009211	278
A0015402870	005640	289	A9068200164	009211	280
A0015406270	005560	307	A9068200256	1605.93605	280
A0015406370	005550	307	A9068200261	1605.92604	277
A0018119933	505.97356	284	A9068200264	009210	278
A0018119933	505.97356	296	A9068200264	009210	280
A0019808464	2405.94100	298	A9068200356	1605.93604	280
A0019808464	2405.94100	306	A9068200464	1505.92001	278
A0019808464	2405.94100	317	A9068200464	1505.92001	280
A0019808464	2405.94100	326	A9068200561	1605.92609	278
A0025440790	011171	289	A9068200661	1605.92608	278
A0025440790	011171	307	A9068201764	1505.92000	278
A0025441290	011181	289	A9068201764	1505.92000	280
A0025441290	011181	307	A9068800170	405.92190	276

ALL ITEMS MENTIONED IN OUR CATALOGUE ARE NOT ORIGINAL PARTS BUT PERFECTLY INTERCHANGEABLE WITH THEM.

GOVERNING LEGISLATIONS FOR THE SALE OF OUR PRODUCTS DIFFER IN EACH COUNTRY.

INFRINGEMENTS, IF ANY, OF LOCAL LEGISLATIONS ARE RESPONSIBILITY OF THE RETAILER IN THE COUNTRY OF FINAL DISTRIBUTION.



A9068800385	105.92101	275	A9608801790-9135	405.96092	329
A9068800570-9B51	405.92191	276	A9608801990-7G99	405.96095	330
A9405010003	2105.94080	298	A9608801990-9135	405.96106	331
A9408200361	1605.94059	298	A9608850181	405.96100	330
A9408200461	1605.94058	298	A9608850311	405.96098	330
A9408900576-7354	205.94083	292	A9608852108-9135	405.96099	330
A9408900676-7354	205.94082	292	A9608853874	405.96097	330
A9415200119	205.20003	300	A9608853974	405.96096	330
A9415200219	205.20002	300	A9608854725-7G99	405.96093	330
A9417200570	1405.94101	305	A9608854725-9135	405.96105	331
A9417600459	1705.94101	306	A9608854825-7G99	405.96094	330
A9417600559	1705.94100	306	A9608854825-9135	405.96104	331
A9418101016	505.94327	283	A9608854925-9135	405.96091	329
A9418101016	505.94327	295	A9608855025-9135	405.96090	329
A9418101016	505.94327	303	A97366625017354	305.97341	282
A9418101016	505.94327	313	A97366626017354	305.97340	282
A9418101016	505.94327	323	A9738200121	1605.97311	286
A9418200521	1605.94163	305	A9738200221	1605.97310	286
A9418200921	1605.94162	305	A9738202461	1605.97317	287
A9436600301-7354	305.94341	310	A9738202561	1605.97316	287
A9436600401-7354	305.94340	310	A9738202661	1605.97315	286
A9436660837-7354	305.94343	310	A9738202761	1605.97314	286
A9436660937-7354	305.94342	310	A97388004707354	405.97381	283
A9438200756	1605.94373	315	A97388005707354	405.97382	283
A9438200756	1605.94373	325	A97388010707354	405.97380	282
A9438200856	1605.94372	315	A97388011707354	405.97390	283
A9438200856	1605.94372	325	A97388016707354	405.97391	283
A9438201461	1605.94365	325	A97388017707354	405.97392	283
A9438201561	1605.94364	325	A9738814701	205.97305	282
A9438201661	1605.94367	325	A9738840185	105.97310	282
A9438201761	1605.94366	325			
A9438800670-7354	405.94361	311			
A9438800670-7354	405.94361	320			
A9438800770-7354	405.94360	311			
A9438800770-7354	405.94360	320			
A9438850201-7354	405.94362	311			
A9438850201-7354	405.94362	320			
A9438850226	405.94363	311			
A9438850226	405.94363	320			
A9438850426-7354	405.94363	311			
A9438850426-7354	405.94363	320			
A9438851222	405.94391	322			
A9438851322	405.94390	322			
A9605200007	205.96018	328			
A9605200007	205.96020	328			
A9605200107	205.96019	328			
A9605200107	205.96021	328			
A9605200520	205.96022	328			
A96052040559135	805.96802	332			
A96052065559135	805.96801	332			
A96052066559135	805.96801	332			
A96052082559135	805.96801	332			
A96052083559135	805.96802	332			
A9605211540	1005.96002	335			
A9608110110	705.96900	332			
A9608111210	705.96901	332			
A9608112310	705.96900	332			
A9608113010	705.96901	332			
A9608200456	1605.96109	334			
A9608200556	1605.96108	334			
A9608200839	1605.96113	335			
A9608200939	1605.96112	335			
A9608200956	1605.96107	334			
A9608201056	1605.96106	334			

COS.IVE

SIMILAR ref.	COS.PEL ref.	PAG
-	002987	450
-	002987	454
-	002987	460
-	002987	470
-	002987	482
-	002987	493
-	002987	499
-	002987	507
-	002987	517
-	003119	485
-	003119	496
-	003119	509
-	003119	520
-	003122	463
-	003122	474
-	003123	357
-	003123	359
-	003123	365
-	003123	399
-	003123	405
-	003123	410
-	003123	415
-	003123	463
-	003123	474
-	003123	485
-	003123	496
-	006140	435
-	006140	446
-	006150	435



-	006150	446	-	1503.45100	496
-	006151	435	-	1503.45100	496
-	006151	447	-	1503.45100	509
-	006152	435	-	1503.45100	509
-	006152	447	-	1503.45100	510
-	006157	509	-	1503.45100	510
-	006157	520	-	1503.45100	520
-	006880	435	-	1503.45100	520
-	006880	447	-	1503.45100	520
-	011111	435	-	1503.45100	520
-	011111	435	-	1503.45101	485
-	011111	446	-	1503.45101	485
-	011111	447	-	1503.45101	485
-	011112	435	-	1503.45101	485
-	011112	447	-	1503.45101	496
-	206.80753	457	-	1503.45101	496
-	206.80753	466	-	1503.45101	496
-	206.80753	476	-	1503.45101	496
-	206.80753	488	-	1503.45101	509
-	206.90207	502	-	1503.45101	509
-	206.90207	512	-	1503.45101	510
-	206.93200	497	-	1503.45101	510
-	206.93201	497	-	1503.45101	520
-	206.93204	501	-	1503.45101	520
-	206.93205	501	-	1503.45101	520
-	306.05627	425	-	1503.45101	520
-	306.05628	425	-	1601.50013	460
-	406.90106	479	-	1601.50013	471
-	406.90107	479	-	1606.40611	365
-	506.35105	343	-	1606.92808	409
-	806.03801	469	-	1606.92808	414
-	806.03802	469	-	1606.92808	508
-	806.90361	491	-	1606.92808	518
-	806.90362	491	-	1606.92809	409
-	1406.60060	369	-	1606.92809	414
-	1406.60061	369	-	1606.92809	508
-	1500.00000	399	-	1606.92809	518
-	1500.00000	405	-	1606.92810	398
-	1500.00000	410	-	1606.92810	403
-	1500.00000	415	-	1606.92810	483
-	1500.00000	464	-	1606.92810	494
-	1500.00000	474	-	1606.92810	518
-	1500.00000	485	-	1606.92811	461
-	1500.00000	496	-	1606.92811	471
-	1500.00001	399	-	1606.92811	483
-	1500.00001	405	-	1606.92811	494
-	1500.00001	410	-	1606.92811	518
-	1500.00001	415	-	1706.19044	420
-	1500.00001	464	-	1706.35122	344
-	1500.00001	474	-	1706.80800	384
-	1500.00001	485	-	1706.80800	389
-	1500.00001	496	-	1706.80800	462
-	1500.00004	357	-	1706.80800	472
-	1500.00004	359	-	1706.80801	384
-	1500.00004	365	-	1706.80801	389
-	1500.00005	357	-	1706.80801	462
-	1500.00005	359	-	1706.80801	472
-	1500.00005	365	-	2000.00010	346
-	1503.45100	485	-	2000.00011	353
-	1503.45100	485	-	2000.00012	434
-	1503.45100	485	-	2000.00201	346
-	1503.45100	485	-	2000.00202	346
-	1503.45100	496	-	2000.00216	435
-	1503.45100	496	-	2000.00251	347

ALL ITEMS MENTIONED IN OUR CATALOGUE ARE NOT ORIGINAL PARTS BUT PERFECTLY INTERCHANGEABLE WITH THEM.

GOVERNING LEGISLATIONS FOR THE SALE OF OUR PRODUCTS DIFFER IN EACH COUNTRY.

INFRINGEMENTS, IF ANY, OF LOCAL LEGISLATIONS ARE RESPONSIBILITY OF THE RETAILER IN THE COUNTRY OF FINAL DISTRIBUTION.



-	2000.00252	435	2997164	206.28934	425
-	3006.00000	373	2997164	206.28934	438
-	3006.00000	380	2997165	206.28251	424
-	3006.00000	385	2997165	206.28251	436
-	3006.00000	390	2997165	206.28254	424
-	3006.00000	434	2997165	206.28254	437
-	3006.00000	446	2997166	206.28252	424
-	3006.00000	474	2997166	206.28252	436
-	3006.00000	485	2997166	206.28253	424
-	3006.00001	365	2997166	206.28253	437
136212	306.08301	523	2997167	206.28257	424
136213	306.08300	523	2997167	206.28257	437
172145	206.07200	522	2997167	206.28259	425
172146	206.07201	522	2997167	206.28259	437
1902779	706.35100	343	2997168	206.28255	424
1904639	003970	347	2997168	206.28255	437
1904640	003980	347	2997168	206.28258	425
1907700	003970	347	2997168	206.28258	437
1907701	003980	347	2997169	206.28256	424
1908138	706.60201	368	2997169	206.28256	437
1908138	706.60201	375	2997174	1906.19026	421
1908809	1406.04802	444	2997175	1906.19027	421
1908810	1406.04803	444	2997176	1906.19028	421
193996	306.07301	522	2997177	1906.19029	421
193997	306.07300	522	2997183	1906.96004	346
2994472	706.39100	351	2997184	1906.96003	346
2994472	706.39100	356	2997185	1906.60030	372
2995675	706.38501	442	2997185	1906.60030	433
2995676	706.43400	429	2997186	1906.60031	372
2996670	506.00011	427	2997186	1906.60031	433
2996670	506.00011	440	2997187	1006.60029	369
2996671	506.00002	427	2997187	1006.60029	383
2996671	506.00002	439	2997187	1006.60029	431
2997103	406.02000	368	2997187	1006.60029	443
2997104	406.43031	426	2997193	1906.96002	346
2997105	406.38450	439	2997194	1906.96001	346
2997106	406.16865	368	2997195	1906.60032	372
2997108	706.39100	351	2997195	1906.60032	384
2997108	706.39100	356	2997195	1906.60032	389
2997118	306.80017	458	2997195	1906.60032	433
2997118	306.80017	467	2997195	1906.60032	446
2997118	306.80025	458	2997195	1906.60032	455
2997118	306.80025	467	2997195	1906.60032	462
2997119	306.80016	458	2997195	1906.60032	473
2997119	306.80016	467	2997195	1906.60032	484
2997119	306.80024	458	2997195	1906.60032	495
2997119	306.80024	467	2997195	1906.60032	500
2997119	306.80026	477	2997195	1906.60032	508
2997119	306.80026	488	2997195	1906.60032	519
2997119	306.80026	503	2997196	1906.60033	372
2997119	306.80026	514	2997196	1906.60033	384
2997119	306.80027	477	2997196	1906.60033	389
2997119	306.80027	488	2997196	1906.60033	433
2997119	306.80027	503	2997196	1906.60033	446
2997119	306.80027	514	2997196	1906.60033	455
2997120	306.66162	449	2997196	1906.60033	462
2997121	306.66161	449	2997196	1906.60033	473
2997123	406.36915	342	2997196	1906.60033	484
2997152	406.43032	426	2997196	1906.60033	495
2997152	406.43032	439	2997196	1906.60033	500
2997156	506.40219	429	2997196	1906.60033	508
2997156	506.40219	441	2997196	1906.60033	519
2997163	206.28933	425	2997316	306.05624	426
2997163	206.28933	437	2997317	306.05623	426



2997318	306.05622	438	3797064	306.79587	449
2997319	306.05621	438	3797065	306.79586	426
2997370	406.75090	381	3797065	306.79586	449
2997493	406.33909	349	3797996	306.79581	425
2997495	406.33910	349	3797996	306.79581	438
2997499	406.33907	349	3797997	306.79580	425
2997500	406.33905	349	3797997	306.79580	438
2997523	306.78199	453	3798109	306.79579	425
2997523	306.78199	498	3798109	306.79579	449
2997524	306.78198	453	3798110	306.79578	425
2997524	306.78198	498	3798110	306.79578	449
2997578	306.80015	458	3798408	306.79589	438
2997578	306.80015	477	3798409	306.79588	438
2997579	306.80014	458	3798583	1006.00007	450
2997579	306.80014	477	3798584	1006.00004	375
2997613	506.38101	351	3798584	1006.00004	379
2997638	406.75091	382	3798584	1006.00004	430
2997670	206.80747	457	3798584	1006.00004	443
2997670	206.80747	466	3798585	1006.00005	379
2997670	206.80747	476	3798585	1006.00005	430
2997670	206.80747	487	3798585	1006.00005	443
2997670	206.80748	457	3798586	1006.00008	369
2997670	206.80748	466	3798586	1006.00008	375
2997670	206.80748	476	3798586	1006.00008	430
2997670	206.80748	487	3798586	1006.00008	443
2997670	206.80748	487	3798586	1006.00008	443
2997670	206.90196	501	3798586	1006.00008	450
2997670	206.90196	512	3798587	1006.00006	430
2997670	206.90208	502	3798587	1006.00006	443
2997670	206.90208	513	3798587	1006.00006	450
2997670	206.92107	503	3798602	306.79585	438
2997670	206.92107	513	3798826	306.79584	438
2997670	1006.80696	463	3798915	306.66170	449
2997670	1006.80696	473	3799162	1406.96755	444
2997730	306.78197	453	3799163	1406.96756	444
2997730	306.78197	498	3799217	406.66100	449
2997731	306.78196	453	3800001	206.39100	354
2997731	306.78196	498	3800001	206.39100	358
2997732	306.78195	453	3800002	206.39101	354
2997732	306.78195	498	3800002	206.39101	358
2997733	306.78194	453	3800056	106.39140	354
2997733	306.78194	498	3800059	106.39141	354
2997734	306.78193	452	3801914	1606.39203	356
2997734	306.78193	497	3801915	1606.39202	356
2997735	306.78192	452	3801926	506.39501	356
2997735	306.78192	497	3801927	506.39500	356
2997736	306.78191	452	3801928	506.39503	356
2997736	306.78191	497	3801929	506.39502	356
2997737	306.78190	452	3802001	406.39190	355
2997737	306.78190	497	3802037	206.39103	355
2997738	306.80013	477	3802038	206.39102	355
2997738	306.80013	488	3802743	406.39189	355
2997738	306.80013	503	3802803	106.39144	354
2997738	306.80013	513	3802804	106.39144	354
2997739	306.80012	477	41002927 sx	206.02927	424
2997739	306.80012	488	41002927 sx	206.02927	436
2997739	306.80012	503	41002927 sx	206.02927	448
2997739	306.80012	513	41003236 dx	206.02927	424
2997740	306.80011	477	41003236 dx	206.02927	436
2997741	306.80010	477	41003236 dx	206.02927	448
3796974	306.79583	426	41027657	1006.78994	454
3796974	306.79583	438	41027658	1006.78995	454
3796975	306.79582	426	41027910	2000.00211	434
3796975	306.79582	438	41032399	206.28251	424
3797064	306.79587	426	41032399	206.28251	436

ALL ITEMS MENTIONED IN OUR CATALOGUE ARE NOT ORIGINAL PARTS BUT PERFECTLY INTERCHANGEABLE WITH THEM.

GOVERNING LEGISLATIONS FOR THE SALE OF OUR PRODUCTS DIFFER IN EACH COUNTRY.

INFRINGEMENTS, IF ANY, OF LOCAL LEGISLATIONS ARE RESPONSIBILITY OF THE RETAILER IN THE COUNTRY OF FINAL DISTRIBUTION.



41032399	206.28254	424	41213721	206.80703	456
41032399	206.28254	437	41213721	206.80703	465
41032400	206.28252	424	41213721	206.80703	475
41032400	206.28252	436	41213721	206.80703	486
41032400	206.28253	424	41213725	1006.90105	481
41032400	206.28253	437	41213725	1006.90105	492
41032401	206.28257	424	41213727	1006.90104	481
41032401	206.28257	437	41213727	1006.90104	492
41032401	206.28259	425	41213729	1006.90103	481
41032401	206.28259	437	41213729	1006.90103	492
41032402	206.28255	424	41213731	1006.90102	481
41032402	206.28255	437	41213731	1006.90102	492
41032402	206.28258	425	41213750	206.80748	457
41032402	206.28258	437	41213750	206.80748	466
41032403	206.28934	425	41213750	206.80748	476
41032403	206.28934	438	41213750	206.80748	487
41032405	206.28934	425	41213750	206.80750	457
41032405	206.28934	438	41213750	206.80750	466
41032406	206.28934	425	41213750	206.80750	476
41032406	206.28934	438	41213750	206.80750	487
41032407	206.28934	425	41213751	206.80747	457
41032407	206.28934	438	41213751	206.80747	466
41032409	206.28933	425	41213751	206.80747	476
41032409	206.28933	437	41213751	206.80747	487
41032410	206.28933	425	41213751	206.80749	457
41032410	206.28933	437	41213751	206.80749	466
41032412	206.28933	425	41213751	206.80749	476
41032412	206.28933	437	41213751	206.80749	487
41032413	206.28933	425	41213753	206.80752	457
41032413	206.28933	437	41213753	206.80752	466
41032513	1006.10241	443	41213753	206.80752	476
41032687	2000.00213	435	41213753	206.80752	487
41200664	002988	450	41213754	206.80751	457
41200664	002988	454	41213754	206.80751	466
41200664	002988	460	41213754	206.80751	476
41200664	002988	470	41213754	206.80751	487
41200664	002988	482	41215631	2106.80080	463
41200664	002988	493	41215631	2106.80080	473
41200664	002988	499	41215631	2106.80080	484
41200664	002988	507	41215631	2106.80080	495
41200664	002988	518	41215632	2106.92080	519
41210241	1006.10241	443	41218983	206.80701	456
41210252	206.28934	425	41218983	206.80701	465
41210252	206.28934	438	41218983	206.80701	475
41210253	206.28934	425	41218983	206.80701	486
41210253	206.28934	438	41218984	206.80700	456
41210254	206.28934	425	41218984	206.80700	465
41210254	206.28934	438	41218984	206.80700	475
41210255	206.28934	425	41218984	206.80700	486
41210255	206.28934	438	41221029 GRIGIO	1606.90603	461
41213696	206.80747	457	41221029 GRIGIO	1606.90603	471
41213696	206.80747	466	41221029 GRIGIO	1606.90603	483
41213696	206.80747	476	41221029 GRIGIO	1606.90603	494
41213696	206.80747	487	41221039 GRIGIO	1606.90602	461
41213696	206.90208	502	41221039 GRIGIO	1606.90602	471
41213696	206.90208	513	41221039 GRIGIO	1606.90602	483
41213696	206.92107	503	41221039 GRIGIO	1606.90602	494
41213696	206.92107	513	41221040	1606.80040	461
41213696	1006.80696	463	41221040	1606.80040	471
41213696	1006.80696	473	41221040	1606.80040	499
41213720	206.80702	456	41221041	1606.80041	461
41213720	206.80702	465	41221041	1606.80041	471
41213720	206.80702	475	41221041	1606.80041	499
41213720	206.80702	486	41225781	806.03651	469



41225782	806.03652	469	42471137	012721	353
41272198	806.90382	491	42471137	012721	373
41288776	206.92105	503	42471137	012721	377
41288776	206.92105	513	42471137	012721	380
41288777	206.92106	503	42471137	012721	385
41288777	206.92106	513	42471138	012621	347
41288783	206.92103	503	42471138	012621	353
41288783	206.92103	513	42471138	012621	373
41288784	206.92101	503	42471138	012621	377
41288784	206.92101	513	42471138	012621	380
41288785	206.92104	503	42471138	012621	385
41288785	206.92104	513	42533495	1006.28934	430
41288786	206.92102	503	42533495	1006.28934	443
41288786	206.92102	513	42533556	206.28251	424
41289079	206.92100	502	42533556	206.28251	436
41289079	206.92100	513	42533556	206.28252	424
41289079	206.92107	503	42533556	206.28252	436
41289079	206.92107	513	42533556	206.28258	425
41289081	206.92101	503	42533556	206.28258	437
41289081	206.92101	513	42533556	206.28259	425
41289082	206.92102	503	42533556	206.28259	437
41289082	206.92102	513	42533556	1001.00001	434
41289087	206.92103	503	42533556	1001.00001	446
41289087	206.92103	513	42533609	206.28256	424
41289088	206.92104	503	42533609	206.28256	437
41289088	206.92104	513	42548403	506.00005	427
41298887	206.90205	502	42548403	506.00005	440
41298887	206.90205	512	42554000	406.75090	381
41298888	206.90206	502	42555022	1606.80040	461
41298888	206.90206	512	42555022	1606.80040	471
41298962	206.90201	502	42555022	1606.80040	499
41298962	206.90201	512	42555023	1606.80041	461
41298964	206.90202	502	42555023	1606.80041	471
41298964	206.90202	512	42555023	1606.80041	499
41298973	206.90203	502	42555041	1606.90604	398
41298973	206.90203	512	42555041	1606.90604	403
41298974	206.90204	502	42555041	1606.90604	483
41298974	206.90204	512	42555041	1606.90604	494
41298975	206.90200	502	42555042	1606.90605	398
41298975	206.90200	512	42555042	1606.90605	403
41298975	206.90208	502	42555042	1606.90605	483
41298975	206.90208	513	42555042	1606.90605	494
41298976	206.90196	501	42555131	013901	357
41298976	206.90196	512	42555132	013901	357
41298976	206.90199	501	42559051	206.28251	424
41298976	206.90199	512	42559051	206.28251	436
41299384	206.80754	457	42559051	206.28252	424
41299384	206.80754	466	42559051	206.28252	436
41299384	206.80754	475	42559051	206.28258	425
41299384	206.80754	486	42559051	206.28258	437
42092364	406.01948	420	42559051	206.28259	425
42324321	206.24321	422	42559051	206.28259	437
42324322	206.24322	422	42559051	1001.00001	434
42324330	206.24323	422	42559051	1001.00001	446
42332745	106.19048	419	42559052	1006.28934	430
42332881	206.32881	419	42559052	1006.28934	443
42332920	306.19049	419	42559053	1006.33602	431
42341982	206.19031	419	42559148	1006.10241	443
42342171	1606.19480	420	42574134	1906.39001	357
42342252	306.42252	419	42574135	1906.39000	357
42343172	1806.19020	421	42575315	1506.92101	510
42348001	1106.48043	420	42575315	1506.92101	510
42348003	406.19048	420	42575315	1506.92101	510
42471137	012721	347	42575315	1506.92101	520

ALL ITEMS MENTIONED IN OUR CATALOGUE ARE NOT ORIGINAL PARTS BUT PERFECTLY INTERCHANGEABLE WITH THEM.

GOVERNING LEGISLATIONS FOR THE SALE OF OUR PRODUCTS DIFFER IN EACH COUNTRY.

INFRINGEMENTS, IF ANY, OF LOCAL LEGISLATIONS ARE RESPONSIBILITY OF THE RETAILER IN THE COUNTRY OF FINAL DISTRIBUTION.



42575315	1506.92101	521	4814210	106.11501	417
42575315	1506.92101	521	4814863	1606.11510	418
42575877	1506.92100	510	4817018	1906.19026	421
42575877	1506.92100	510	4817019	1906.19027	421
42575877	1506.92100	510	4817201	1906.19028	421
42575877	1506.92100	510	4817202	1906.19029	421
42575877	1506.92100	520	4856063	1906.96002	346
42575877	1506.92100	521	4856064	1906.96001	346
42575877	1506.92100	521	4861793	1606.48440	432
42575877	1506.92100	521	4861793	1606.48440	445
4588444	106.68201	526	4861794	1606.48441	432
4597675	106.68202	526	4861794	1606.48441	445
4605163	1006.90107	372	4862220	1606.75918	369
4605163	1006.90107	377	4862220	1606.75918	376
4605163	1006.90107	380	500042691	406.13091	387
4605163	1006.90107	385	500042691	406.13091	392
4605163	1006.90107	390	500042692	406.13090	386
4605163	1006.90107	399	500042692	406.13090	392
4605163	1006.90107	404	500042693	406.17138	375
4605163	1006.90107	409	500042694	406.17137	375
4605163	1006.90107	415	500051520	706.40100	362
4605163	1006.90107	434	500054914	406.33909	349
4605163	1006.90107	446	500305102	1606.05102	431
4605163	1006.90107	451	500305102	1606.05102	445
4605163	1006.90107	455	500305103	1606.05103	431
4605163	1006.90107	463	500305103	1606.05103	445
4605163	1006.90107	473	500307754	1606.35012	352
4605163	1006.90107	484	500307755	1606.35013	352
4605163	1006.90107	495	500308514	003001	460
4605163	1006.90107	500	500308514	003001	471
4605163	1006.90107	509	500312439	306.33101	349
4605163	1006.90107	519	500312441	306.33100	349
4689964	206.89964	526	500314227	1706.38123	352
4703771	306.44030	422	500314228	1706.38122	352
4703772	306.44031	422	500314229	1906.20011	353
4722470	106.22470	422	500314230	1906.20010	353
4784894	1006.90109	372	500314716	1606.75921	370
4784894	1006.90109	377	500314716	1606.75921	376
4784894	1006.90109	380	500314716	1606.75921	431
4784894	1006.90109	385	500314716	1606.75921	444
4784894	1006.90109	390	500314717	1606.75920	370
4784894	1006.90109	399	500314717	1606.75920	376
4784894	1006.90109	404	500314717	1606.75920	431
4784894	1006.90109	410	500314717	1606.75920	444
4784894	1006.90109	415	500316865	406.16865	368
4784894	1006.90109	434	500316950	2000.00206	373
4784894	1006.90109	446	500316960	1606.35929	352
4784894	1006.90109	451	500316961	1606.35928	352
4784894	1006.90109	455	500317137	406.17137	375
4784894	1006.90109	463	500317145	406.15089	378
4784894	1006.90109	473	500317145	406.15090	378
4784894	1006.90109	484	500317145	406.15091	379
4784894	1006.90109	495	500317944	206.17944	367
4784894	1006.90109	500	500317945	206.17945	367
4784894	1006.90109	509	500317946	206.17944	367
4784894	1006.90109	519	500317947	206.17945	367
4786002	306.11530	417	500317956	206.17956	374
4786003	306.11531	417	500317978	206.15010	378
4786006	406.11533	417	500317979	206.15011	378
4786009	106.11503	417	500318079	206.17957	374
4786977	1706.19042	420	500318229	306.15031	378
4786978	1706.19043	420	500318230	306.15030	378
4787184	206.11523	417	500318238	306.42645	375
4787187	206.11522	417	500318241	306.42644	375



500318289	206.18339	374	500368110	1606.36364	431
500318293	206.18339	374	500368110	1606.36364	444
500318338	206.18338	374	500368111	1606.36365	431
500318341	206.18340	367	500368111	1606.36365	444
500318345	206.18341	367	500368694	1006.70604	460
500319558	1606.35930	353	500368694	1006.70604	469
500319559	1606.35931	353	500368694	1006.70604	481
500320425	1606.35914	351	500368694	1006.70604	492
500320426	1606.35915	351	500368694	1006.70604	506
500320427	1606.35914	351	500368694	1006.70604	517
500320428	1606.35915	351	500370048	1406.80094	470
500325708	506.38097	350	500370049	1406.80095	470
500325709	506.38096	350	500371327	506.38100	350
500325710	506.38097	350	500371329	506.38101	351
500325711	506.38096	350	500375430	306.80017	458
500325725	506.38099	350	500375430	306.80017	467
500325726	506.38098	350	500375430	306.80025	458
500325747	506.38095	350	500375430	306.80025	467
500325748	506.38094	350	500375431	306.80016	458
500326797	206.23139	348	500375431	306.80016	467
500326798	206.23140	348	500375431	306.80024	458
500326801	206.23142	349	500375431	306.80024	467
500326802	206.23141	349	500375431	306.80026	477
500326835	406.33921	349	500375431	306.80026	488
500326836	406.33920	349	500375431	306.80026	503
500326870	400.02000	350	500375431	306.80026	514
500326870	400.02000	355	500375431	306.80027	477
500326871	400.00001	350	500375431	306.80027	488
500327275	806.27275	351	500375431	306.80027	503
500328136	1606.35920	351	500375431	306.80027	514
500328137	1606.35921	351	500375472	206.90099	487
500328278	106.46218	348	500375472	206.90099	511
500329761	1706.38119	352	500380066	406.70096	382
500332454	400.02001	350	500380066	406.70096	387
500332454	400.02001	355	500380066	406.70096	392
500333817	1006.34401	351	500380066	406.70096	396
500333905	406.33905	349	500380094	406.83945	382
500333907	406.33907	349	500380094	406.83945	387
500335296	1706.60902	370	500380094	406.83945	392
500335296	1706.60902	432	500380094	406.83945	459
500335296	1706.60902	445	500380094	406.83945	468
500337600	1006.34400	351	500380095	406.83944	382
500337805	706.43401	429	500380095	406.83944	387
500339321	1406.38005	351	500380095	406.83944	392
500339322	1406.38004	351	500380095	406.83944	459
500340361	1606.75122	370	500380095	406.83944	468
500340361	1606.75122	376	500380102	406.83942	458
500340408	1606.75121	370	500380102	406.83942	468
500340408	1606.75121	376	500380104	406.83943	458
500340503	1606.75200	370	500380104	406.83943	468
500340503	1606.75200	376	500380111	406.90102	459
500340543	1606.75201	370	500380111	406.90102	468
500340543	1606.75201	376	500380111	406.90102	479
500340695	1606.75916	369	500380111	406.90102	490
500340695	1606.75916	376	500380111	406.90102	505
500340696	1606.75917	369	500380111	406.90102	515
500340696	1606.75917	376	500380112	1006.70100	383
500348517	806.27275	351	500380112	1006.70100	388
500355252	1606.35922	352	500382616	008560	373
500355253	1606.35923	352	500382616	008560	377
500356782	008590	353	500382616	008560	380
500356783	008600	353	500382616	008560	385
500359924	2406.60101	373	500382617	008550	373
500359930	2406.60100	372	500382617	008550	377

ALL ITEMS MENTIONED IN OUR CATALOGUE ARE NOT ORIGINAL PARTS BUT PERFECTLY INTERCHANGEABLE WITH THEM.

GOVERNING LEGISLATIONS FOR THE SALE OF OUR PRODUCTS DIFFER IN EACH COUNTRY.

INFRINGEMENTS, IF ANY, OF LOCAL LEGISLATIONS ARE RESPONSIBILITY OF THE RETAILER IN THE COUNTRY OF FINAL DISTRIBUTION.



500382617	008550	380	504020193	1606.80039	384
500382617	008550	385	504020193	1606.80039	389
500383459	406.70096	382	504020193	1606.80039	393
500383459	406.70096	387	504020193	1606.80039	461
500383459	406.70096	392	504020193	1606.80039	472
500383459	406.70096	396	504021635	1801.36000	353
500383946	406.83946	468	504022497	1406.80984	470
500383947	406.83947	459	504022498	1406.80985	470
500389853	406.05627	439	504022499	1406.80983	470
500389854	406.05628	439	504022500	1406.80982	470
500390551	2406.83100	463	504022657	1006.90100	481
500390551	2406.83100	473	504022657	1006.90100	492
500396753	1406.96753	444	504022658	1006.90101	481
500396754	1406.96754	444	504022658	1006.90101	492
500396838	1006.90108	482	504027461	106.75461	381
500396838	1006.90108	493	504027461	106.75461	386
500396838	1006.90108	507	504027461	106.75461	391
500396838	1006.90108	517	504027536	206.75300	381
500398112	106.80106	465	504027537	206.75301	381
500420558	306.08301	523	504027559	906.75282	368
500420559	306.08300	523	504027559	906.75282	375
500431530	106.08100	523	504027559	906.75282	379
5006182631	416.00011	528	504027559	906.75282	382
5006218166	416.00060	529	504027559	906.75282	387
5006218166	416.00061	529	504027559	906.75282	392
5006221163	416.00070	529	504027559	906.75282	397
503645305	1806.35014	345	504027559	906.75282	402
504001344	306.80021	458	504027559	906.75282	408
504001344	306.80021	467	504027559	906.75282	413
504001344	306.80021	477	504027560	906.75283	368
504001345	306.80020	458	504027560	906.75283	375
504001345	306.80020	467	504027560	906.75283	379
504001345	306.80020	477	504027560	906.75283	382
504001358	306.80019	458	504027560	906.75283	387
504001358	306.80019	467	504027560	906.75283	392
504001358	306.80019	477	504027560	906.75283	397
504001361	306.80018	458	504027560	906.75283	402
504001361	306.80018	467	504027560	906.75283	408
504001361	306.80018	477	504027560	906.75283	413
504003992	206.54009	452	504027613	406.75090	381
504003992	206.54009	456	504027614	406.75091	382
504003992	206.54009	465	504027618	406.13090	386
504003993	206.54008	452	504027618	406.13090	392
504003993	206.54008	456	504027620	406.13091	387
504003993	206.54008	465	504027620	406.13091	392
5040053092	306.78203	498	504032145	1606.80042	461
504008290	406.90108	479	504032145	1606.80042	472
504009774	406.33900	350	504032148	1606.80043	462
504016123	306.80607	467	504032148	1606.80043	472
504016124	306.80606	467	504032325	406.90102	459
504016485	306.80603	467	504032325	406.90102	468
504016519	306.80602	467	504032325	406.90102	479
504017159	306.80605	467	504032325	406.90102	490
504017160	306.80604	467	504032325	406.90102	505
504017177	1006.80177	469	504032325	406.90102	515
504017178	1006.80178	469	504032787	1006.70106	383
504017580	1006.80580	469	504032787	1006.70106	388
504020073	206.90098	487	504032787	1006.70106	393
504020073	206.90098	511	504032787	1006.70106	397
504020189	1606.80038	384	504032787	1006.70106	403
504020189	1606.80038	389	504032791	1006.70103	383
504020189	1606.80038	393	504032791	1006.70103	388
504020189	1606.80038	461	504032791	1006.70103	393
504020189	1606.80038	472	504032791	1006.70103	397



504032791	1006.70103	403	504043051	406.75093	387
504032792	2406.75100	373	504043051	406.75093	392
504032792	2406.75100	377	504043052	406.75093	382
504032792	2406.75100	380	504043052	406.75093	387
504032792	2406.75100	385	504043052	406.75093	392
504032792	2406.75100	390	504043817	1006.18000	382
504032792	2406.75100	394	504043817	1006.18000	387
504032792	2406.75100	399	504043817	1006.18000	392
504032792	2406.75100	405	504043817	1006.18000	397
504032792	2406.75100	410	504043819	1006.18001	388
504032792	2406.75100	415	504043819	1006.18001	393
504032799	1006.70105	383	504044980	1406.80980	470
504032799	1006.70105	388	504044981	1406.80981	470
504032799	1006.70105	393	504045133	1606.75603	393
504032799	1006.70105	397	504045133	1606.75603	461
504032799	1006.70105	403	504045133	1606.75603	471
504032799	1006.70105	408	504045193	1406.80094	470
504032799	1006.70105	413	504045194	1406.80095	470
504033938	306.80600	458	504046218	106.46218	348
504033938	306.80600	467	504047264	1606.80047	383
504033939	306.80601	458	504047264	1606.80047	388
504033939	306.80601	467	504047264	1606.80047	393
504037735	206.75120	381	504047264	1606.80047	398
504037737	206.75121	381	504047264	1606.80047	403
504040988	1906.90030	385	504047264	1606.80047	461
504040988	1906.90030	390	504047264	1606.80047	471
504040988	1906.90030	394	504047264	1606.80047	483
504040988	1906.90030	399	504047264	1606.80047	494
504040988	1906.90030	455	504047265	1606.80046	383
504040988	1906.90030	463	504047265	1606.80046	388
504040988	1906.90030	473	504047265	1606.80046	393
504040988	1906.90030	484	504047265	1606.80046	398
504040988	1906.90030	495	504047265	1606.80046	403
504040988	1906.90030	500	504047265	1606.80046	461
504040988	1906.90030	509	504047265	1606.80046	471
504040988	1906.90030	519	504047265	1606.80046	483
504040989	1906.90031	385	504047265	1606.80046	494
504040989	1906.90031	390	504047573	1606.75600	383
504040989	1906.90031	394	504047573	1606.75600	388
504040989	1906.90031	399	504047585	206.70533	475
504040989	1906.90031	455	504047586	206.70532	475
504040989	1906.90031	463	504049432	1006.70104	383
504040989	1906.90031	473	504049432	1006.70104	388
504040989	1906.90031	484	504049432	1006.70104	393
504040989	1906.90031	495	504049432	1006.70104	397
504040989	1906.90031	500	504049432	1006.70104	403
504040989	1906.90031	509	504049432	1006.70104	408
504040989	1906.90031	519	504049432	1006.70104	413
504042187	406.83945	382	504049813	406.13090	386
504042187	406.83945	387	504049813	406.13090	392
504042187	406.83945	392	504049814	406.13091	387
504042187	406.83945	459	504049814	406.13091	392
504042187	406.83945	468	504052236	206.75124	381
504042188	406.83944	382	504052237	206.75123	381
504042188	406.83944	387	504052352	1606.75602	384
504042188	406.83944	392	504052352	1606.75602	389
504042188	406.83944	459	504052353	1606.75601	384
504042188	406.83944	468	504052353	1606.75601	389
504042191	406.70096	382	504052936	1706.80802	384
504042191	406.70096	387	504052936	1706.80802	389
504042191	406.70096	392	504052936	1706.80802	462
504042191	406.70096	396	504052936	1706.80802	472
504042824	706.80700	469	504053093	306.78204	498
504043051	406.75093	382	504053527	1906.20011	353

ALL ITEMS MENTIONED IN OUR CATALOGUE ARE NOT ORIGINAL PARTS BUT PERFECTLY INTERCHANGEABLE WITH THEM.

GOVERNING LEGISLATIONS FOR THE SALE OF OUR PRODUCTS DIFFER IN EACH COUNTRY.

INFRINGEMENTS, IF ANY, OF LOCAL LEGISLATIONS ARE RESPONSIBILITY OF THE RETAILER IN THE COUNTRY OF FINAL DISTRIBUTION.



504053528	1906.20010	353	504081118	1406.80982	470
504054940	206.13000	386	504081120	1406.80983	470
504054941	206.13001	386	504089372	706.70600	459
504054942	206.13002	386	504089372	706.70600	481
504054943	206.13003	386	504090861	206.90100	476
504054990	206.18011	391	504090861	206.90100	487
504054991	206.18012	391	504090862	206.90101	476
504054992	206.18013	391	504090862	206.90101	487
504055010	306.18020	391	504091075	406.78092	453
504055011	306.18021	391	504091076	406.78091	453
504055140	206.13040	386	504096162	906.80162	469
504055140	206.13040	391	504096163	906.80163	469
504055141	206.13041	386	504097971	1006.78997	454
504055141	206.13041	391	504097984	306.78201	453
504055623	1606.75604	393	504097984	306.78202	453
504055623	1606.75604	461	504097984	306.78202	498
504055623	1606.75604	471	504097988	416.00030	530
504056033	906.70180	454	504097996	306.78202	453
504056033	906.70180	459	504097996	306.78202	498
504056034	906.70181	454	504097996	1006.78996	454
504056034	906.70181	459	504098243 grigio	1606.80044	461
504056436	106.70436	452	504098243 grigio	1606.80044	471
504056436	106.70436	456	504098245 grigio	1606.80045	461
504056838	706.70600	459	504098245 grigio	1606.80045	471
504056838	706.70600	481	504099351	406.33910	349
504056864	506.38097	350	504099353	406.33909	349
504056878	506.38096	350	504099511	406.33922	349
504056893	506.38094	350	504099511	406.33922	355
504056898	506.38095	350	504099511	406.33922	358
504058445	206.75120	381	504099512	406.33923	349
504058446	206.75121	381	504099512	406.33923	355
504058447	206.75124	381	504099512	406.33923	358
504058448	206.75123	381	504102117	406.75093	382
504059309	206.13000	386	504102117	406.75093	387
504059310	206.13001	386	504102117	406.75093	392
504060073	406.78090	453	504102299	206.70533	475
504060076	306.18020	391	504102899	306.78200	453
504060077	306.18021	391	504102899	306.78202	453
504060280	906.75280	382	504102899	306.78202	498
504060280	906.75280	387	504102900	306.78202	453
504060280	906.75280	392	504102900	306.78202	498
504060280	906.75280	397	504103111	406.83949	459
504060280	906.75280	402	504103112	406.83947	459
504060281	906.75281	382	504103124	406.83948	468
504060281	906.75281	387	504103125	406.83946	468
504060281	906.75281	392	504103232	306.78199	453
504060281	906.75281	397	504103232	306.78199	498
504060281	906.75281	402	504103233	306.78198	453
504061726	706.75300	382	504103233	306.78198	498
504061726	706.75300	387	504103234	306.78197	453
504061726	706.75300	397	504103234	306.78197	498
504061726	706.75300	402	504103235	306.78196	453
504065982	406.74676	459	504103235	306.78196	498
504065982	406.74676	468	504103236	306.78195	453
504065984	406.80101	459	504103236	306.78195	498
504065984	406.80101	468	504103237	306.78194	453
504065985	406.80100	459	504103237	306.78194	498
504065985	406.80100	468	504103238	206.70531	452
504074676	406.74677	459	504103238	206.70531	456
504074676	406.74677	468	504103239	206.70530	452
504076983	506.88887	429	504103239	206.70530	456
504076983	506.88887	442	504103239	206.70530	456
504080951	206.75300	381	504103300	206.70532	475
504080952	206.75301	381	504103305	206.90099	487
			504103305	206.90099	511



504103307	206.80540	465	504135514	406.90103	479
504103308	206.90098	487	504135514	406.90103	490
504103308	206.90098	511	504135514	406.90103	505
504104465	1606.35917	351	504135514	406.90103	516
504104467	1606.35916	351	504135530	406.92076	516
504104575	1606.35924	352	504135532	406.92075	516
504104577	1606.35925	352	504136555	306.80013	477
504104580	1606.35926	352	504136555	306.80013	488
504104582	1606.35927	352	504136555	306.80013	503
504104892	206.80541	465	504136555	306.80013	513
504105684	416.00020	530	504136556	306.80012	477
504107220	706.43402	430	504136556	306.80012	488
504107239	706.38500	442	504136556	306.80012	503
504107550	1606.75925	408	504136556	306.80012	513
504107550	1606.75925	414	504136561	306.80011	477
504108987	206.80541	465	504136562	306.80010	477
504110983	106.02002	367	504138502	206.90197	511
504110983	106.02002	374	504138503	206.90198	511
504110983	106.02002	378	504139860	1406.75006	383
504116073	906.75281	382	504139860	1406.75006	388
504116073	906.75281	387	504139860	1406.75006	393
504116073	906.75281	392	504139861	1406.75005	383
504116073	906.75281	397	504139861	1406.75005	388
504116073	906.75281	402	504139861	1406.75005	393
504116074	906.75280	382	504146434	706.90800	491
504116074	906.75280	387	504146530 con staffe	706.90800	491
504116074	906.75280	392	504150526	506.90101	490
504116074	906.75280	397	504150527	506.90100	490
504116074	906.75280	402	504157968	1906.90030	385
504116083	906.75283	368	504157968	1906.90030	390
504116083	906.75283	375	504157968	1906.90030	394
504116083	906.75283	379	504157968	1906.90030	399
504116083	906.75283	382	504157968	1906.90030	455
504116083	906.75283	387	504157968	1906.90030	463
504116083	906.75283	392	504157968	1906.90030	473
504116083	906.75283	397	504157968	1906.90030	484
504116083	906.75283	402	504157968	1906.90030	495
504116083	906.75283	408	504157968	1906.90030	500
504116083	906.75283	413	504157968	1906.90030	509
504116084	906.75282	368	504157968	1906.90030	519
504116084	906.75282	375	504157969	1906.90031	385
504116084	906.75282	379	504157969	1906.90031	390
504116084	906.75282	382	504157969	1906.90031	394
504116084	906.75282	387	504157969	1906.90031	399
504116084	906.75282	392	504157969	1906.90031	455
504116084	906.75282	397	504157969	1906.90031	463
504116084	906.75282	402	504157969	1906.90031	473
504116084	906.75282	408	504157969	1906.90031	484
504116084	906.75282	413	504157969	1906.90031	495
504132243	506.00013	428	504157969	1906.90031	500
504132243	506.00013	440	504157969	1906.90031	509
504132244	506.00012	428	504157969	1906.90031	519
504132244	506.00012	440	504158937	506.90113	480
504132248	506.00011	427	504158937	506.90113	491
504132248	506.00011	440	504158943	506.90112	480
504132249	506.00002	427	504158943	506.90112	491
504132249	506.00002	439	504158947	506.90111	481
504132808	206.90096	486	504158947	506.90111	491
504132808	206.90096	511	504158951	506.90114	481
504132811	206.90096	486	504158951	506.90114	491
504132811	206.90096	511	504158974	506.90105	396
504133023	1606.75924	408	504158974	506.90105	402
504133023	1606.75924	414	504158974	506.90105	480
504135514	406.90103	401	504158974	506.90105	490

ALL ITEMS MENTIONED IN OUR CATALOGUE ARE NOT ORIGINAL PARTS BUT PERFECTLY INTERCHANGEABLE WITH THEM.

GOVERNING LEGISLATIONS FOR THE SALE OF OUR PRODUCTS DIFFER IN EACH COUNTRY.

INFRINGEMENTS, IF ANY, OF LOCAL LEGISLATIONS ARE RESPONSIBILITY OF THE RETAILER IN THE COUNTRY OF FINAL DISTRIBUTION.



504158975	506.90104	396	504187294	406.90092	478
504158975	506.90104	402	504187294	406.90092	489
504158975	506.90104	480	504187294	406.90092	505
504158975	506.90104	490	504187294	406.90092	515
504158976	506.90107	397	504187339	406.90093	478
504158976	506.90107	402	504187339	406.90093	489
504158976	506.90107	480	504187339	406.90093	505
504158976	506.90107	490	504187339	406.90093	515
504158977	506.90106	397	504187426	406.90094	478
504158977	506.90106	402	504187426	406.90094	489
504158977	506.90106	480	504187426	406.90094	505
504158977	506.90106	490	504187426	406.90094	515
504161149	306.78193	452	504187427	406.90095	478
504161149	306.78193	497	504187427	406.90095	489
504161150	306.78192	452	504187427	406.90095	505
504161150	306.78192	497	504187427	406.90095	515
504161151	306.78191	452	504187506	406.90096	479
504161151	306.78191	497	504187506	406.90096	489
504161152	306.78190	452	504187506	406.90096	505
504161152	306.78190	497	504187506	406.90096	515
504168236	506.90108	480	504187507	406.90097	479
504168236	506.90108	490	504187507	406.90097	489
504168244	506.90109	480	504187507	406.90097	505
504168244	506.90109	491	504187507	406.90097	515
504170809	106.90100	486	504187939	406.90104	479
504170848	106.90100	486	504187940	406.90105	479
504170979	106.90200	475	504188129	406.90100	489
504171187	1006.90187	482	504188129	406.90100	505
504171187	1006.90187	493	504188130	406.90101	489
504173477	406.90099	479	504188130	406.90101	505
504173477	406.90099	489	504190697	406.90087	478
504173477	406.90099	505	504190697	406.90087	489
504173477	406.90099	515	504190699	406.90088	478
504173478	406.90098	479	504190699	406.90088	489
504173478	406.90098	489	504190700	406.90089	478
504173478	406.90098	505	504190700	406.90089	489
504173478	406.90098	515	504190747	406.90084	478
504173483	1006.90483	398	504190747	406.90084	488
504173483	1006.90483	482	504190780	406.90082	478
504173483	1006.90483	493	504190780	406.90082	488
504173487	1006.90487	482	504190781	406.90083	478
504173487	1006.90487	493	504190781	406.90083	488
504173866	1906.20010	353	504194532	406.90108	479
504173868	1906.20011	353	504194533	406.90109	479
504181095	1606.90606	398	504194581	1006.90110	398
504181095	1606.90606	404	504194581	1006.90110	403
504181095	1606.90606	409	504194581	1006.90110	460
504181095	1606.90606	414	504194581	1006.90110	470
504181095	1606.90606	483	504194581	1006.90110	482
504181095	1606.90606	494	504194581	1006.90110	493
504181096	1606.90607	483	504194581	1006.90110	507
504181096	1606.90607	494	504194581	1006.90110	517
504186928	406.90085	488	504194669	406.90102	459
504186928	406.90085	514	504194669	406.90102	468
504186929	406.90081	488	504194669	406.90102	479
504186929	406.90081	514	504194669	406.90102	490
504186929	406.90090	488	504194669	406.90102	505
504186929	406.90090	514	504194669	406.90102	515
504186932	406.90080	477	504197878	506.90102	396
504186932	406.90080	503	504197878	506.90102	402
504186932	406.90086	477	504197878	506.90102	480
504186932	406.90086	504	504197878	506.90102	490
504186932	406.90091	478	504197879	506.90103	396
504186932	406.90091	504	504197879	506.90103	402



504197879	506.90103	480	504238117	1606.90601	494
504197879	506.90103	490	504238117	1606.90601	499
504203320	1806.36001	353	504242345	1006.70532	460
504203320	1806.36001	356	504242345	1006.70532	481
504203397	906.80163	469	504242345	1006.70532	506
504203478	906.70181	454	504242346	1006.70533	460
504203478	906.70181	459	504242346	1006.70533	481
504208706	206.54009	452	504242346	1006.70533	506
504208706	206.54009	456	504245477	406.39191	355
504208706	206.54009	465	504245478	406.39193	355
504208707	206.54008	452	504245479	406.39192	355
504208707	206.54008	456	504250958 NERO	1606.90603	461
504208707	206.54008	465	504250958 NERO	1606.90603	471
504211219	206.90097	486	504250958 NERO	1606.90603	483
504211219	206.90097	511	504250958 NERO	1606.90603	494
504211274	206.70531	452	504250984 NERO	1606.90602	461
504211274	206.70531	456	504250984 NERO	1606.90602	471
504211274	206.93203	497	504250984 NERO	1606.90602	483
504211275	206.70530	452	504250984 NERO	1606.90602	494
504211275	206.70530	456	504250991 nero	1606.80045	461
504211275	206.93202	497	504250991 nero	1606.80045	471
504211437	1006.80540	469	504250999 nero	1606.80044	461
504211437	1006.80540	492	504250999 nero	1606.80044	471
504211437	1006.80540	517	504256916	1006.90916	482
504211438	1006.80541	469	504258137	406.70094	396
504211438	1006.80541	492	504258138	406.70095	396
504211438	1006.80541	517	504258139	406.70096	382
504211611	1406.80980	470	504258139	406.70096	387
504211612	1406.80981	470	504258139	406.70096	392
504215971 grigio	306.80015	458	504258139	406.70096	396
504215971 grigio	306.80015	477	504258162	406.16096	401
504215973 grigio	306.80014	458	504258213	406.70091	395
504215973 grigio	306.80014	477	504258217	106.70100	395
504217525 nero	306.80021	458	504258217	106.70100	400
504217525 nero	306.80021	467	504272597	406.70095	396
504217525 nero	306.80021	477	504272598	406.70094	396
504217526 nero	306.80020	458	504273162	406.70097	396
504217526 nero	306.80020	467	504273162	406.70097	401
504217526 nero	306.80020	477	504273184	406.16094	401
504217553 nero	306.80019	458	504273185	406.16095	401
504217553 nero	306.80019	467	504273193	406.70092	395
504217553 nero	306.80019	477	504273193	406.70092	401
504217554 nero	306.80018	458	504273199	406.70093	395
504217554 nero	306.80018	467	504273199	406.70093	401
504217554 nero	306.80018	477	504274012	406.70098	396
504218911	306.78199	453	504274012	406.70098	401
504218911	306.78199	498	504274013	406.70099	396
504218912	306.78198	453	504274013	406.70099	401
504218912	306.78198	498	504281887	406.70090	395
504221272	406.79090	498	504281888	406.70091	395
504221320	406.79092	498	504281893	406.16090	400
504221321	406.79091	498	504281894	406.16091	400
504224428	506.90110	480	504281895	406.16091	400
504224428	506.90110	491	504281899	406.16092	400
504232501	1406.04802	444	504281900	406.16093	401
504232504	1406.04803	444	504281901	406.16093	401
504238093	1606.90600	398	504284009	406.70093	395
504238093	1606.90600	404	504284009	406.70093	401
504238093	1606.90600	483	504284010	406.70092	395
504238093	1606.90600	494	504284010	406.70092	401
504238093	1606.90600	499	504284012	406.70096	382
504238117	1606.90601	398	504284012	406.70096	387
504238117	1606.90601	404	504284012	406.70096	392
504238117	1606.90601	483	504284012	406.70096	396

ALL ITEMS MENTIONED IN OUR CATALOGUE ARE NOT ORIGINAL PARTS BUT PERFECTLY INTERCHANGEABLE WITH THEM.

GOVERNING LEGISLATIONS FOR THE SALE OF OUR PRODUCTS DIFFER IN EACH COUNTRY.

INFRINGEMENTS, IF ANY, OF LOCAL LEGISLATIONS ARE RESPONSIBILITY OF THE RETAILER IN THE COUNTRY OF FINAL DISTRIBUTION.



504284018	406.16093	401	504369979	506.70101	401
504284315	406.90081	488	504369995	506.70100	396
504284315	406.90081	514	504369995	506.70100	401
504284315	406.90090	488	504370048	506.90099	479
504284315	406.90090	514	504370048	506.90099	498
504284316	406.90080	477	504370055	506.90098	479
504284316	406.90080	503	504370055	506.90098	498
504284316	406.90086	477	5801255053	406.39190	355
504284316	406.90086	504	5801255055	406.39189	355
504284316	406.90091	478	5801255767	106.39145	354
504284316	406.90091	504	5801324893	1906.90031	385
504287143	406.90085	488	5801324893	1906.90031	390
504287143	406.90085	514	5801324893	1906.90031	394
504299045	206.70121	395	5801324893	1906.90031	399
504299045	206.70121	406	5801324893	1906.90031	455
504299444	206.70120	395	5801324893	1906.90031	463
504299444	206.70120	406	5801324893	1906.90031	473
504301907	206.18014	400	5801324893	1906.90031	484
504301907	206.18014	411	5801324893	1906.90031	495
504301912	206.18015	400	5801324893	1906.90031	500
504301912	206.18015	411	5801324893	1906.90031	509
504306106	1006.70604	460	5801324893	1906.90031	519
504306106	1006.70604	469	5801324907	1906.90030	385
504306106	1006.70604	481	5801324907	1906.90030	390
504306106	1006.70604	492	5801324907	1906.90030	394
504306106	1006.70604	506	5801324907	1906.90030	399
504306106	1006.70604	517	5801324907	1906.90030	455
504329071	1006.70110	414	5801324907	1906.90030	463
504329073	1006.70107	403	5801324907	1906.90030	473
504329073	1006.70107	414	5801324907	1906.90030	484
504329074	1006.70108	403	5801324907	1906.90030	495
504329074	1006.70108	414	5801324907	1906.90030	500
504329077	1006.70101	402	5801324907	1906.90030	509
504329077	1006.70101	413	5801324907	1906.90030	519
504329078	1006.70102	402	5801336285	506.90099	479
504329078	1006.70102	413	5801336285	506.90099	498
504356351	1906.39000	357	5801336298	506.90098	479
504356352	1906.39001	357	5801336298	506.90098	498
504359964	2106.40080	365	5801339946	406.41096	359
504364956	1806.36001	353	5801339976	406.41097	359
504364956	1806.36001	356	5801341206	506.70101	396
504368370 nero	306.80014	458	5801341206	506.70101	401
504368370 nero	306.80014	477	5801341207	506.70100	396
504368371 nero	306.80015	458	5801341207	506.70100	401
504368371 nero	306.80015	477	5801342732	106.41100	358
504368373	306.80022	503	5801350675	406.41090	358
504368373	306.80022	513	5801350677	406.41093	359
504368376	306.80023	503	5801350681	406.41095	359
504368376	306.80023	513	5801351218	003951	357
504368379	306.80013	477	5801351224	003950	357
504368379	306.80013	488	5801352974	206.39101	354
504368379	306.80013	503	5801352974	206.39101	358
504368379	306.80013	513	5801352978	206.39100	354
504368383	306.80012	477	5801352978	206.39100	358
504368383	306.80012	488	5801362619	406.41091	358
504368383	306.80012	503	5801362625	406.41094	359
504368383	306.80012	513	5801362626	406.41092	359
504369796	506.90114	481	5801363428	006153	509
504369796	506.90114	491	5801363428	006153	520
504369798	506.90111	481	5801363431	006154	509
504369798	506.90111	491	5801363431	006154	520
504369910	506.90101	490	5801363432	006155	509
504369961	506.90100	490	5801363432	006155	520
504369979	506.70101	396	5801367568	506.39498	356



5801367571	506.39499	356	5801572018	1606.92802	518
5801367608	506.39497	356	5801572024	1606.92803	507
5801367641	506.39496	356	5801572024	1606.92803	518
5801375415	1606.41034	359	5801572074	1606.92806	508
5801375416	1606.41035	359	5801572074	1606.92806	518
5801377880	1606.41032	359	5801572080	1606.92807	508
5801377881	1606.41033	359	5801572080	1606.92807	518
5801473749	1606.40600	365	5801573143	1606.75924	408
5801473750	1606.40601	365	5801573143	1606.75924	414
5801492603	106.40100	360	5801573145	1606.75925	408
5801512484	1006.40107	364	5801573145	1606.75925	414
5801512513	1006.40106	364	5801580230	506.90098	479
5801513863	106.40103	360	5801580230	506.90098	498
5801513990	1006.40108	364	5801580261	506.70101	396
5801513992	206.40151	360	5801580261	506.70101	401
5801513999	206.40150	360	5801580263	506.70100	396
5801521532	806.40002	362	5801580263	506.70100	401
5801521533	806.40003	362	5801582700	406.40096	362
5801521540	806.40004	363	5801582711	406.40095	362
5801521541	806.40005	363	5801584081	406.92074	516
5801523220	1606.40605	366	5801584082	406.92073	516
5801523221	1606.40606	366	5801585146	1606.40603	364
5801527115	1706.18000	409	5801585151	1606.40602	364
5801529742	406.40090	361	5801587018	106.40102	360
5801529858	1106.40080	364	5801587021	1606.40604	365
5801529859	1106.40081	364	5801592113	606.92300	491
5801530197	806.40008	363	5801592113	606.92300	516
5801530199	806.40009	363	5801592114	806.92301	492
5801530202	206.40158	361	5801592114	806.92301	516
5801540269	806.40011	363	5801592119	806.92302	492
5801540271	806.40012	363	5801592119	806.92302	516
5801541041	406.40099	361	5801603578	406.90081	488
5801541042	406.40100	361	5801603578	406.90081	514
5801546522	1606.92804	507	5801603578	406.90090	488
5801546522	1606.92804	518	5801603578	406.90090	514
5801546548	1606.92805	507	5801603586	406.90080	477
5801546548	1606.92805	518	5801603586	406.90080	503
5801546918	906.92190	517	5801603586	406.90091	478
5801549064	106.92100	511	5801603586	406.90091	504
5801549092	106.92101	501	5801603597	406.90081	488
5801549092	106.92101	511	5801603597	406.90081	514
5801549124	1006.40109	364	5801603597	406.90090	488
5801550647	106.93150	497	5801603597	406.90090	514
5801550647	106.93150	501	5801603636	406.40097	362
5801552552	506.40501	362	5801605084	1006.40105	363
5801552553	506.40500	362	5801605499	406.40091	362
5801552904	906.92191	517	5801606287	406.16096	401
5801557592	1506.40601	366	5801609147	406.16094	401
5801557593	1506.40602	366	5801609160	406.16095	401
5801562137	406.92072	504	5801610735	1606.40610	364
5801562137	406.92072	514	5801610737	1606.40609	364
5801562166	406.92071	504	5801618728	1006.40102	363
5801562166	406.92071	514	5801618730	1006.40103	363
5801562167	406.92070	504	5801618741	1006.40104	363
5801562167	406.92070	514	5801620745	1006.40101	363
5801562215	1106.40082	364	5801622723	206.18014	400
5801562216	1106.40083	364	5801622723	206.18014	411
5801564804	906.93180	499	5801627043	406.40101	361
5801564804	906.93180	506	5801627054	406.40102	361
5801564805	906.93181	499	5801627396	406.40101	361
5801564805	906.93181	506	5801629789	406.40094	362
5801565740	806.40006	363	5801629792	406.40093	362
5801565760	806.40010	363	5801629858	1606.92814	499
5801572018	1606.92802	507	5801629859	1606.92813	499

ALL ITEMS MENTIONED IN OUR CATALOGUE ARE NOT ORIGINAL PARTS BUT PERFECTLY INTERCHANGEABLE WITH THEM.

GOVERNING LEGISLATIONS FOR THE SALE OF OUR PRODUCTS DIFFER IN EACH COUNTRY.

INFRINGEMENTS, IF ANY, OF LOCAL LEGISLATIONS ARE RESPONSIBILITY OF THE RETAILER IN THE COUNTRY OF FINAL DISTRIBUTION.



5801630222	406.40098	362	5801698798	806.93602	506
5801630551	1006.40100	363	5801698838	806.93603	506
5801631615	002986	408	5801698846	806.93605	506
5801631615	002986	414	5801711046	106.18152	406
5801631615	002986	499	5801711046	106.18152	411
5801631615	002986	507	5801711048	106.18153	406
5801631615	002986	517	5801711048	106.18153	411
5801637182	1506.92011	510	5801715565	706.92100	516
5801637182	1506.92011	521	5801715566	706.93200	506
5801637199	1506.92009	510	5801715570 con staffe	706.92100	516
5801637199	1506.92009	520	5801733767	106.18154	406
5801637201	1506.92008	510	5801733767	106.18154	411
5801637201	1506.92008	520	5801735386	806.92308	492
5801637702	1506.92010	510	5801735398	806.92309	492
5801637702	1506.92010	521	5801736696	506.39498	356
5801672866	806.92304	492	5801736705	506.39499	356
5801672866	806.92304	516	5801738337	1606.71700	408
5801673301	806.92305	516	5801738337	1606.71700	414
5801690072	106.18150	406	5801745441	1606.92799	508
5801690072	106.18150	411	5801745441	1606.92799	518
5801690084	106.18151	406	5801745442	1606.92798	508
5801690084	106.18151	411	5801745442	1606.92798	518
5801690102	906.71181	408	5801745449	1606.92801	409
5801690102	906.71181	413	5801745449	1606.92801	414
5801690105	906.71180	408	5801745449	1606.92801	508
5801690105	906.71180	413	5801745452	1606.92800	409
5801690552	406.71091	407	5801745452	1606.92800	414
5801690553	406.71092	407	5801745452	1606.92800	508
5801690583	406.18100	412	5801754885	1606.92806	508
5801690585	406.18101	412	5801754885	1606.92806	518
5801690586	406.18102	412	5801754886	1606.92807	508
5801690588	406.18103	412	5801754886	1606.92807	518
5801690590	406.18104	412	5801754888	1606.92814	499
5801690628	406.18105	412	5801754889	1606.92813	499
5801691384	406.18090	412	5801755107	1606.92802	507
5801691386	406.18089	412	5801755107	1606.92802	518
5801692253	406.18092	413	5801755108	1606.92803	507
5801692254	406.18091	413	5801755108	1606.92803	518
5801692828	406.18098	413	5801755123	1606.90604	398
5801692841	406.18099	413	5801755123	1606.90604	403
5801692850	406.18096	413	5801755123	1606.90604	483
5801692854	406.18097	413	5801755123	1606.90604	494
5801692865	406.18094	413	5801755132	1606.90605	398
5801692867	406.18095	413	5801755132	1606.90605	403
5801692884	406.71099	407	5801755132	1606.90605	483
5801693353	406.71092	407	5801755132	1606.90605	494
5801693423	406.71100	408	5801755709	506.39497	356
5801693424	406.71101	408	5801755754	506.39496	356
5801693428	406.71102	408	5801757326	1506.92014	510
5801693429	406.71103	408	5801757326	1506.92014	521
5801693456	406.71094	407	5801757328	1506.92012	510
5801693457	406.71093	407	5801757328	1506.92012	521
5801693487	406.71096	407	580176195	506.90101	490
5801693491	406.71095	407	580176196	506.90100	490
5801693540	406.71098	407	5801765379	506.90108	480
5801693556	406.71097	407	5801765379	506.90108	490
5801696201	406.71090	407	5801772690	406.40090	361
5801698293	206.92101	503	5801772693	106.40101	360
5801698293	206.92101	513	5801797763	406.70090	395
5801698294	206.92102	503	5801797764	406.70091	395
5801698294	206.92102	513	5801797825	406.70090	395
5801698762	606.93601	506	5801797858	406.70091	395
5801698782	606.93600	506	5801797941	406.70091	395
5801698793	806.93604	506	5801802740	406.16090	400



5801802741	406.16091	400	5802000770	1506.92004	520
5801802888	406.16093	401	5802000772	1506.92006	485
5801802895	406.16092	400	5802000772	1506.92006	496
5801802903	406.16093	401	5802000772	1506.92006	510
5801804152	2000.00203	365	5802000772	1506.92006	520
5801804153	406.16091	400	5802028036	506.40501	362
5801804155	406.16093	401	5802028037	506.40500	362
5801806044	506.90110	480	5802032045	506.39499	356
5801806044	506.90110	491	5802055272	1506.92013	510
5801808067	806.40000	362	5802055272	1506.92013	521
5801808084	806.40001	362	5802055273	1506.92007	485
5801811189	806.40007	363	5802055273	1506.92007	496
5801811471	806.40006	363	5802055273	1506.92007	510
5801811665	806.40008	363	5802055273	1506.92007	520
5801811680	806.40009	363	5802055522	906.71180	408
5801812254	806.40010	363	5802055522	906.71180	413
5801823334	1606.40608	364	5802055523	906.71181	408
5801823572	1606.40607	364	5802055523	906.71181	413
5801840462	206.80540	465	5802055590	406.92081	514
5801840490	206.80541	465	5802055590	406.92085	515
5801840545	206.90098	487	5802055590	406.92090	515
5801840545	206.90098	511	5802055590	406.92090	515
5801840550	206.90099	487	5802055591	406.93081	504
5801840550	206.90099	511	5802055591	406.93086	504
5801840558	206.90096	486	5802055591	406.93091	504
5801840558	206.90096	511	5802062276	406.92090	515
5801840561	206.90096	486	5802062689	1506.92001	485
5801840561	206.90096	511	5802062689	1506.92001	496
5801840565	206.90097	486	5802062689	1506.92001	509
5801840565	206.90097	511	5802062689	1506.92001	520
5801847132	206.40157	361	5802066514	406.93081	504
5801847137	206.40156	361	5802066514	406.93086	504
5801847150	206.40155	361	5802066514	406.93091	504
5801847156	206.40154	361	5802067033	406.92090	515
5801847591	1406.80980	470	5802067261	406.92085	515
5801847596	1406.80981	470	5802132944	1706.60907	371
5801863940	206.40153	361	5802132944	1706.60907	377
5801863943	206.40152	361	5802132944	1706.60907	380
5801874639	1606.40602	364	5802132944	1706.60907	384
5801874640	1606.40603	364	5802132944	1706.60907	389
5801912787	1706.18000	409	5802132944	1706.60907	399
5801938050	406.18093	407	5802132944	1706.60907	404
5801938050	406.18093	412	5802132944	1706.60907	409
5801974516	406.92077	504	5802132944	1706.60907	415
5801974516	406.92077	514	5802132944	1706.60907	432
5802000568	1506.92003	485	5802132944	1706.60907	445
5802000568	1506.92003	496	5802132944	1706.60907	450
5802000568	1506.92003	509	5802132944	1706.60907	455
5802000568	1506.92003	520	5802132944	1706.60907	462
5802000570	1506.92005	485	5802132944	1706.60907	472
5802000570	1506.92005	496	5802132944	1706.60907	484
5802000570	1506.92005	510	5802132944	1706.60907	495
5802000570	1506.92005	520	5802132944	1706.60907	508
5802000573	1506.92000	485	5802132944	1706.60907	519
5802000573	1506.92000	496	5802132946	1706.60908	371
5802000573	1506.92000	509	5802132946	1706.60908	377
5802000573	1506.92000	520	5802132946	1706.60908	380
5802000767	1506.92002	485	5802132946	1706.60908	384
5802000767	1506.92002	496	5802132946	1706.60908	389
5802000767	1506.92002	509	5802132946	1706.60908	399
5802000767	1506.92002	520	5802132946	1706.60908	404
5802000770	1506.92004	485	5802132946	1706.60908	409
5802000770	1506.92004	496	5802132946	1706.60908	415
5802000770	1506.92004	510	5802132946	1706.60908	432

ALL ITEMS MENTIONED IN OUR CATALOGUE ARE NOT ORIGINAL PARTS BUT PERFECTLY INTERCHANGEABLE WITH THEM.

GOVERNING LEGISLATIONS FOR THE SALE OF OUR PRODUCTS DIFFER IN EACH COUNTRY.

INFRINGEMENTS, IF ANY, OF LOCAL LEGISLATIONS ARE RESPONSIBILITY OF THE RETAILER IN THE COUNTRY OF FINAL DISTRIBUTION.



5802132946	1706.60908	445	8142610	1006.00005	379
5802132946	1706.60908	450	8142610	1006.00005	430
5802132946	1706.60908	455	8142610	1006.00005	443
5802132946	1706.60908	462	8142611	1006.00004	375
5802132946	1706.60908	472	8142611	1006.00004	379
5802132946	1706.60908	484	8142611	1006.00004	430
5802132946	1706.60908	495	8142611	1006.00004	443
5802132946	1706.60908	508	8142616	306.15030	378
5802132946	1706.60908	519	8142617	306.15031	378
5802341775	106.40101	360	8142621	206.18342	367
5802510213	406.40090	361	8142626	206.18343	367
581631433	003950	357	8142629	206.18337	374
581631438	003951	357	8142630	206.18336	374
5949782801	106.09100	524	8142799	1806.60121	371
5949782807	906.09901	525	8142799	1806.60121	432
5949782808	906.09900	525	8142800	1806.60122	371
5949800615	306.09301	524	8142800	1806.60122	432
5949800616	306.09300	524	8142801	1806.60125	371
5949800617	306.09303	524	8142801	1806.60125	433
5949800619	306.09302	524	8142802	1806.60126	371
5949800620	306.09305	524	8142802	1806.60126	433
5949800621	306.09304	524	8142842	206.42842	368
5949801377	306.09307	524	8142843	206.42483	375
5949801378	306.09306	524	8143031	406.43031	426
60164734	206.08200	527	8143032	406.43032	426
69500010	1606.39200	356	8143032	406.43032	439
69500013	1606.39201	356	8143033	406.43033	426
69500026	003950	357	8143033	406.43033	439
69500032	003951	357	8143221	406.15089	378
69500590	1606.41030	359	8143221	406.15091	379
69500591	1606.41031	359	8143416	106.43890	423
69500805	1506.39002	357	8143812	1206.43812	369
69500806	1506.39003	357	8143812	1206.43812	379
7984015	012621	347	8143813	1206.43813	369
7984015	012621	353	8143813	1206.43813	379
7984015	012621	373	8143851	1806.60120	371
7984015	012621	377	8143852	1806.24015	432
7984015	012621	380	8143852	1806.24015	462
7984015	012621	385	8143853	1806.44015	445
7984016	012721	347	8143853	1806.44015	472
7984016	012721	353	8144314	206.44003	423
7984016	012721	373	8144314	206.44003	448
7984016	012721	377	8144315	206.44002	423
7984016	012721	380	8144315	206.44002	448
7984016	012721	385	8144317	206.44005	423
8123386	506.19048	420	8144318	206.44004	423
8142404	1806.60132	372	8144328	206.44001	423
8142404	1806.60132	433	8144328	206.44001	448
8142413	106.02002	367	8144329	206.44000	423
8142413	106.02002	374	8144329	206.44000	448
8142413	106.02002	378	8144468	206.00001	423
8142427	1206.42427	443	8144468	206.00001	436
8142428	1206.42428	443	8144468	206.00001	448
8142590	406.02000	368	8144469	206.00002	423
8142601	406.17138	375	8144469	206.00002	436
8142603	206.02000	367	8144469	206.00002	448
8142604	206.01999	367	8166285	2106.43081	451
8142605	206.17958	374	9068599	406.11514	416
8142607	1006.00008	369	9068641	206.68640	416
8142607	1006.00008	375	9068642	206.68639	416
8142607	1006.00008	430	9070228	306.70228	416
8142607	1006.00008	443	9070229	306.70229	416
8142607	1006.00008	450	93017949	1706.19045	420
8142609	206.17959	374	93160520	506.35104	343



93160521	506.35104	343	93926309	1806.35018	345
93161844	011110	435	93926310	1806.35017	345
93161844	011110	435	93926317	1806.35015	345
93161844	011110	447	93926687	1706.35123	344
93161844	011110	447	93926734	1906.96004	346
93161844	011110	509	93926735	1906.96003	346
93161844	011110	509	93926823	406.03510	342
93161844	011110	520	93926824	406.03511	342
93161844	011110	520	93926848	1706.35130	345
93162831	706.43400	429	93928072	506.35102	343
93168568	416.00062	529	93928073	506.35103	343
93190970	506.00017	428	93928166	1706.35128	344
93190970	506.00017	441	93928272	1006.25038	343
93190971	506.40215	428	93929967	1806.35022	345
93190971	506.40215	441	93930986	1806.35014	345
93190973	506.00018	428	93931353	1806.35022	345
93190973	506.00018	441	93932871	306.35020	342
93190974	506.40217	428	93933106 (spezzone)	1806.35020	345
93190974	506.40217	441	93933130	106.33130	341
93190976	506.00016	428	93933538	206.23138	341
93190976	506.00016	441	93934202	406.03851	342
93190977	506.40216	428	93934203	406.03850	342
93190977	506.40216	441	93936134	1706.35121	344
93193161	506.40218	429	93936135	1706.35120	344
93193161	506.40218	441	93936405	1706.35130	345
93193197	506.00003	427	93936852	506.35101	343
93193197	506.00003	440	93936853	506.35100	343
93193198	506.00004	427	93936854	506.35103	343
93193198	506.00004	440	93936855	506.35102	343
93193199	506.00005	427	93936913	406.36915	342
93193199	506.00005	440	93936924	406.03850	342
93193202	506.40219	429	93936925	406.03851	342
93193202	506.40219	441	93936994	206.23136	341
93193203	506.40220	429	93936995	206.23137	341
93193203	506.40220	442	93937476	106.37476	341
93193206	506.40220	429	93937668	106.37668	341
93193206	506.40220	442	93937669	106.37669	341
93806655	400.01900	342	93937670	106.37668	341
93807247	400.01900	342	93938673	1706.35129	345
93807247	400.01901	342	93938863	406.36915	342
93824452	2000.00250	346	93939907	406.03514	342
93828917	1006.25037	343	93939908	406.03513	342
93902026	1806.35012	345	93939909	406.03515	342
93902121	1806.35023	346	93940727	1806.35012	345
93914768	106.23102	340	93941270	1906.96004	346
93914769	106.23103	340	93941271	1906.96003	346
93923131	206.23131	341	93941625	406.36915	342
93923132	206.23132	341	97169308	1801.36000	353
93923150	106.23150	340	98404709	1706.60900	370
93923737	106.23737	341	98404709	1706.60900	432
93923758	106.33130	341	98404709	1706.60900	445
93924351	106.23100	340	98404710	1706.60901	370
93924352	106.23101	340	98404710	1706.60901	432
93924614	106.23152	340	98404710	1706.60901	445
93924652	106.23151	340	98404714	1706.60902	370
93924714	1706.35127	344	98404714	1706.60902	432
93924716	1706.35125	344	98404714	1706.60902	445
93924717	1706.35126	344	98404902	1806.60133	372
93924822	1006.25034	343	98404902	1806.60133	377
93924823	1006.25033	343	98404902	1806.60133	380
93924973	1006.25037	343	98404902	1806.60133	384
93925035	1006.25035	343	98404902	1806.60133	389
93925036	1006.25036	343	98404902	1806.60133	399
93926149	1806.35012	345	98404902	1806.60133	404

ALL ITEMS MENTIONED IN OUR CATALOGUE ARE NOT ORIGINAL PARTS BUT PERFECTLY INTERCHANGEABLE WITH THEM.

GOVERNING LEGISLATIONS FOR THE SALE OF OUR PRODUCTS DIFFER IN EACH COUNTRY.

INFRINGEMENTS, IF ANY, OF LOCAL LEGISLATIONS ARE RESPONSIBILITY OF THE RETAILER IN THE COUNTRY OF FINAL DISTRIBUTION.



98404902	1806.60133	409	98411951	1706.60906	445
98404902	1806.60133	415	98411951	1706.60906	450
98404902	1806.60133	433	98411951	1706.60906	454
98404902	1806.60133	445	98411951	1706.60906	462
98404902	1806.60133	451	98411951	1706.60906	472
98404902	1806.60133	455	98411951	1706.60906	484
98404902	1806.60133	462	98411951	1706.60906	495
98404902	1806.60133	473	98411951	1706.60906	508
98404902	1806.60133	484	98411951	1706.60906	519
98404902	1806.60133	495	98411952	1706.60905	371
98404902	1806.60133	508	98411952	1706.60905	377
98404902	1806.60133	519	98411952	1706.60905	379
98405560	306.05560	438	98411952	1706.60905	384
98405561	306.05561	438	98411952	1706.60905	389
98407721	1906.60032	372	98411952	1706.60905	398
98407721	1906.60032	384	98411952	1706.60905	404
98407721	1906.60032	389	98411952	1706.60905	409
98407721	1906.60032	433	98411952	1706.60905	415
98407721	1906.60032	446	98411952	1706.60905	432
98407721	1906.60032	455	98411952	1706.60905	445
98407721	1906.60032	462	98411952	1706.60905	450
98407721	1906.60032	473	98411952	1706.60905	454
98407721	1906.60032	484	98411952	1706.60905	462
98407721	1906.60032	495	98411952	1706.60905	472
98407721	1906.60032	500	98411952	1706.60905	484
98407721	1906.60032	508	98411952	1706.60905	495
98407721	1906.60032	519	98411952	1706.60905	508
98407722	1906.60033	372	98411952	1706.60905	519
98407722	1906.60033	384	98416236	1006.60029	369
98407722	1906.60033	389	98416236	1006.60029	383
98407722	1906.60033	433	98416236	1006.60029	431
98407722	1906.60033	446	98416236	1006.60029	443
98407722	1906.60033	455	98416419	1706.60906	371
98407722	1906.60033	462	98416419	1706.60906	377
98407722	1906.60033	473	98416419	1706.60906	379
98407722	1906.60033	484	98416419	1706.60906	384
98407722	1906.60033	495	98416419	1706.60906	389
98407722	1906.60033	500	98416419	1706.60906	398
98407722	1906.60033	508	98416419	1706.60906	404
98407722	1906.60033	519	98416419	1706.60906	409
98407741	1906.60030	372	98416419	1706.60906	415
98407741	1906.60030	433	98416419	1706.60906	432
98407744	1906.60031	372	98416419	1706.60906	445
98407744	1906.60031	433	98416419	1706.60906	450
98408393	1806.60123	371	98416419	1706.60906	454
98408393	1806.60123	433	98416419	1706.60906	462
98408394	1806.60124	371	98416419	1706.60906	472
98408394	1806.60124	433	98416419	1706.60906	484
98409362	1806.60128	371	98416419	1706.60906	495
98409362	1806.60128	433	98416419	1706.60906	508
98409363	1806.60127	371	98416419	1706.60906	519
98409363	1806.60127	433	98416424	1706.60905	371
98409491	2106.43080	434	98416424	1706.60905	377
98409491	2106.43080	446	98416424	1706.60905	379
98411951	1706.60906	371	98416424	1706.60905	384
98411951	1706.60906	377	98416424	1706.60905	389
98411951	1706.60906	379	98416424	1706.60905	398
98411951	1706.60906	384	98416424	1706.60905	404
98411951	1706.60906	389	98416424	1706.60905	409
98411951	1706.60906	398	98416424	1706.60905	415
98411951	1706.60906	404	98416424	1706.60905	432
98411951	1706.60906	409	98416424	1706.60905	445
98411951	1706.60906	415	98416424	1706.60905	450
98411951	1706.60906	432	98416424	1706.60905	454



98416424	1706.60905	462	98463023	1706.60903	371
98416424	1706.60905	472	98463023	1706.60903	377
98416424	1706.60905	484	98463023	1706.60903	379
98416424	1706.60905	495	98463024	1706.60904	371
98416424	1706.60905	508	98463024	1706.60904	377
98416424	1706.60905	519	98463024	1706.60904	379
98417357	306.05624	426	98464670	406.02001	368
98417358	306.05623	426	98466161	306.66162	449
98419234	1606.36363	431	98466162	306.66161	449
98419234	1606.36363	444	98466328	306.66164	448
98419235	1606.36362	431	98466330	306.66163	448
98419235	1606.36362	444	98472974	506.00013	428
98421202	008550	373	98472974	506.00013	440
98421202	008550	377	98472975	506.00012	428
98421202	008550	380	98472975	506.00012	440
98421202	008550	385	98472976	506.88886	429
98421203	008560	373	98472976	506.88886	442
98421203	008560	377	98472977	506.00009	427
98421203	008560	380	98472977	506.00009	440
98421203	008560	385	98472979	506.00001	427
98424105	506.33000	368	98472979	506.00001	439
98424107	506.19048	420	98472981	506.88888	429
98426669	2106.70080	404	98472981	506.88888	442
98429699	306.05626	425	98472982	506.00010	427
98429703	306.05625	425	98472982	506.00010	440
98433912	1606.33912	344	98472983	506.00000	426
98433913	1606.33913	344	98472983	506.00000	439
98433939	1606.93900	344	98472986	506.88887	429
98433940	1606.93901	344	98472986	506.88887	442
98433941	1606.93902	344	98472987	506.00011	427
98433942	1606.93903	344	98472987	506.00011	440
98437200	3000.02005	369	98473007	506.00001	427
98437475	1606.60110	370	98473007	506.00001	439
98437475	1606.60110	376	98473008	506.88888	429
98437475	1606.60110	432	98473008	506.88888	442
98437476	1606.60111	370	98473011	506.00000	426
98437476	1606.60111	376	98473011	506.00000	439
98437476	1606.60111	432	98473012	506.88887	429
98438450	406.38450	439	98473012	506.88887	442
98438466	306.05622	438	98473849	406.43034	368
98438467	306.05621	438	98473849	406.43034	426
98442028	206.42028	436	98473849	406.43034	439
98442029	206.42029	436	98474429	1006.90106	369
98444262	2406.60101	373	98474429	1006.90106	450
98444263	2406.60100	372	98474429	1006.90106	454
98445371	706.66100	449	98474429	1006.90106	460
98449181	1606.48480	444	98474429	1006.90106	470
98449182	1606.48481	444	98474429	1006.90106	481
98452333	1006.00003	430	98474429	1006.90106	493
98452333	1006.00003	442	98474429	1006.90106	499
98452368	1006.00002	430	98474429	1006.90106	507
98452368	1006.00002	442	98474429	1006.90106	517
98456508	206.42843	368	98476371	2406.36100	434
98459188	406.66103	449	98480268	406.66101	449
98460036	1606.36360	431	98480269	406.66102	449
98460038	1606.36361	431	98483247	2406.48100	446
98461648	1606.75923	370	98484152	1806.60134	372
98461648	1606.75923	376	98484152	1806.60134	377
98461648	1606.75923	431	98484152	1806.60134	380
98461648	1606.75923	444	98484152	1806.60134	384
98461649	1606.75922	370	98484152	1806.60134	389
98461649	1606.75922	376	98484152	1806.60134	399
98461649	1606.75922	431	98484152	1806.60134	404
98461649	1606.75922	444	98484152	1806.60134	409

ALL ITEMS MENTIONED IN OUR CATALOGUE ARE NOT ORIGINAL PARTS BUT PERFECTLY INTERCHANGEABLE WITH THEM.

GOVERNING LEGISLATIONS FOR THE SALE OF OUR PRODUCTS DIFFER IN EACH COUNTRY.

INFRINGEMENTS, IF ANY, OF LOCAL LEGISLATIONS ARE RESPONSIBILITY OF THE RETAILER IN THE COUNTRY OF FINAL DISTRIBUTION.



98484152	1806.60134	415	99477376	2000.00200	346
98484152	1806.60134	433	99485357	1906.96002	346
98484152	1806.60134	445	99485358	1906.96001	346
98484152	1806.60134	451	99487780	1906.60032	372
98484152	1806.60134	455	99487780	1906.60032	384
98484152	1806.60134	462	99487780	1906.60032	389
98484152	1806.60134	473	99487780	1906.60032	433
98484152	1806.60134	484	99487780	1906.60032	446
98484152	1806.60134	495	99487780	1906.60032	455
98484152	1806.60134	508	99487780	1906.60032	462
98484152	1806.60134	519	99487780	1906.60032	473
98499858	406.43033	426	99487780	1906.60032	484
98499858	406.43033	439	99487780	1906.60032	495
99442399	416.00067	529	99487780	1906.60032	500
99452662	1606.75919	370	99487780	1906.60032	508
99452662	1606.75919	376	99487780	1906.60032	519
99452662	1606.75919	379	99487781	1906.60033	372
99463242	006142	435	99487781	1906.60033	384
99463242	006142	447	99487781	1906.60033	389
99463243	006141	435	99487781	1906.60033	433
99463243	006141	447	99487781	1906.60033	446
99463244	006143	435	99487781	1906.60033	455
99463244	006143	447	99487781	1906.60033	462
99471666	106.71666	348	99487781	1906.60033	473
99476267	1706.60908	371	99487781	1906.60033	484
99476267	1706.60908	377	99487781	1906.60033	495
99476267	1706.60908	380	99487781	1906.60033	500
99476267	1706.60908	384	99487781	1906.60033	508
99476267	1706.60908	389	99487781	1906.60033	519
99476267	1706.60908	399	99489371	206.23134	348
99476267	1706.60908	404	99489589	1706.38121	352
99476267	1706.60908	409	99489590	1706.38120	352
99476267	1706.60908	415	99489793	206.23134	348
99476267	1706.60908	432	99489794	206.23133	348
99476267	1706.60908	445	99489805	206.23133	348
99476267	1706.60908	450	99489947	106.89947	348
99476267	1706.60908	455			
99476267	1706.60908	462			
99476267	1706.60908	472			
99476267	1706.60908	484			
99476267	1706.60908	495			
99476267	1706.60908	508			
99476267	1706.60908	519			
99476268	1706.60907	371			
99476268	1706.60907	377			
99476268	1706.60907	380			
99476268	1706.60907	384			
99476268	1706.60907	389			
99476268	1706.60907	399			
99476268	1706.60907	404			
99476268	1706.60907	409			
99476268	1706.60907	415			
99476268	1706.60907	432			
99476268	1706.60907	445			
99476268	1706.60907	450			
99476268	1706.60907	455			
99476268	1706.60907	462			
99476268	1706.60907	472			
99476268	1706.60907	484			
99476268	1706.60907	495			
99476268	1706.60907	508			
99476268	1706.60907	519			
99477139	1806.60131	372			
99477139	1806.60131	433			

COS.MA

SIMILAR ref.	COS.PEL ref.	PAG
-	003092	536
-	003092	540
-	003092	544
-	003092	561
-	003092	573
-	003092	602
-	003092	611
-	003120	536
-	003120	540
-	003120	544
-	003120	561
-	003120	573
-	003120	602
-	003120	611
-	003123	573
-	003123	587
-	006132	573
-	006133	573
-	011112	573
-	1500.00000	573
-	1500.00000	587
-	1500.00001	573
-	1500.00001	587



-	1607.00717	570	8125225-6544	1507.10001	561
-	1607.10750	585	8125225-6544	1507.10001	573
-	1607.10750	601	8125225-6544	1507.10001	603
-	2000.00016	573	8125225-6544	1507.10001	611
-	3007.00000	536	8125225-6545	1507.10000	537
-	3007.00000	546	8125225-6545	1507.10000	540
-	3007.00000	561	8125225-6545	1507.10000	544
-	3007.00000	572	8125225-6545	1507.10000	561
-	3007.00000	578	8125225-6545	1507.10000	573
-	3007.00000	587	8125225-6545	1507.10000	603
-	3007.00000	602	8125225-6545	1507.10000	611
-	3007.00001	536	8125225-6547	1507.10002	537
81061026098	2107.02080	550	8125225-6547	1507.10002	541
81061026099	2107.02080	550	8125225-6547	1507.10002	544
81061026110	2107.02081	550	8125225-6547	1507.10002	561
81061026112	2107.02081	550	8125225-6547	1507.10002	573
81061026201	2107.02080	550	8125225-6547	1507.10002	603
81061026202	2107.02080	550	8125225-6547	1507.10002	611
81061026205	2107.02081	550	81252286027	006130	551
81061026209	2107.02081	550	81252286027	1504.10501	551
81061026218	2107.02080	550	81252286028	006120	551
81251016448	1607.00700	571	81252286028	1504.10500	551
81251016449	1607.00701	571	81252296055	011111	551
81251016450	1607.00702	571	81252296055	011111	551
81251016451	1607.00703	571	8125229-6059	1507.10101	537
81251016498	1607.10754	585	8125229-6059	1507.10101	540
81251016498	1607.10754	601	8125229-6059	1507.10101	544
81251016499	1607.10755	585	8125229-6059	1507.10101	561
81251016499	1607.10755	601	8125229-6059	1507.10101	573
81251016503	1607.10749	585	8125229-6059	1507.10101	603
81251016503	1607.10749	601	8125229-6059	1507.10101	611
81251016504	1607.10748	585	8125229-6060	1507.10100	537
81251016504	1607.10748	601	8125229-6060	1507.10100	537
81251016521	1607.10753	585	8125229-6060	1507.10100	540
81251016521	1607.10753	601	8125229-6060	1507.10100	541
81251016522	1607.10752	585	8125229-6060	1507.10100	544
81251016522	1607.10752	601	8125229-6060	1507.10100	544
81251016657	1607.10747	585	8125229-6060	1507.10100	561
81251016657	1607.10747	601	8125229-6060	1507.10100	561
81251016658	1607.10746	585	8125229-6060	1507.10100	573
81251016658	1607.10746	601	8125229-6060	1507.10100	573
81251016659	1607.10755	585	8125229-6060	1507.10100	603
81251016659	1607.10755	601	8125229-6060	1507.10100	603
81251016660	1607.10754	585	8125229-6060	1507.10100	611
81251016660	1607.10754	601	8125229-6060	1507.10100	611
81251016663	1607.10749	585	81252606099	1607.00713	559
81251016663	1607.10749	601	81252606099	1607.00713	570
81251016664	1607.10748	585	81252606099	1607.00713	577
81251016664	1607.10748	601	81252606099	1607.00713	585
81251016681	1607.10747	585	81252606101	1607.00710	559
81251016681	1607.10747	601	81252606101	1607.00710	570
81251016682	1607.10746	585	81252606101	1607.00710	577
81251016682	1607.10746	601	81252606121	1607.00714	559
81251016683	1607.10755	585	81252606121	1607.00714	570
81251016683	1607.10755	601	81252606121	1607.00714	577
81251016684	1607.10754	585	81252606121	1607.00714	601
81251016684	1607.10754	601	81253206089	1607.00715	571
81251016687	1607.10749	585	81253206090	1607.00716	571
81251016687	1607.10749	601	81253206091	1607.00705	571
81251016688	1607.10748	585	81253206092	1607.00704	571
81251016688	1607.10748	601	81253206100	1607.00712	559
8125225-6544	1507.10001	537	81253206100	1607.00712	570
8125225-6544	1507.10001	540	81253206100	1607.00712	577
8125225-6544	1507.10001	544	81253206102	1607.00711	559

ALL ITEMS MENTIONED IN OUR CATALOGUE ARE NOT ORIGINAL PARTS BUT PERFECTLY INTERCHANGEABLE WITH THEM.

GOVERNING LEGISLATIONS FOR THE SALE OF OUR PRODUCTS DIFFER IN EACH COUNTRY.

INFRINGEMENTS, IF ANY, OF LOCAL LEGISLATIONS ARE RESPONSIBILITY OF THE RETAILER IN THE COUNTRY OF FINAL DISTRIBUTION.



81253206102	1607.00711	570	81416100409	407.15189	582
81253206102	1607.00711	577	81416100414	407.26092	538
81253206111	1607.00705	571	81416100415	407.26093	538
81253206112	1607.00704	571	81416100463	407.26110	540
81253206113	1607.00707	571	81416100463	407.26110	543
81253206114	1607.00706	571	81416100464	407.26111	540
81253206115	1607.00708	559	81416100464	407.26111	543
81253206115	1607.00708	570	81416100471	407.26099	539
81253206115	1607.00708	577	81416100471	407.26099	542
81253206116	1607.00709	559	81416100472	407.26098	539
81253206116	1607.00709	570	81416100472	407.26098	542
81253206116	1607.00709	577	81416100532	407.11100	591
81253206117	1607.00708	559	81416100532	407.11100	609
81253206117	1607.00708	570	81416100533	407.11099	591
81253206117	1607.00708	577	81416100533	407.11099	609
81253206118	1607.00709	559	81416100558	407.11102	609
81253206118	1607.00709	570	81416100559	407.11101	609
81253206118	1607.00709	577	81416100560	407.12086	592
81416100150	407.00150	548	81416100561	407.12087	592
81416100151	407.00151	548	81416100562	407.26107	539
81416100152	407.00152	548	81416100562	407.26107	543
81416100164	407.04120	549	81416100563	407.26108	539
81416100166	407.04118	549	81416100563	407.26108	543
81416100167	407.04119	549	81416100568	407.15190	582
81416100191	407.00191	548	81416100569	407.15189	582
81416100223	407.25290	534	81416100575	407.11098	591
81416100224	407.25190	534	81416100575	407.11098	609
81416100225	407.00225	556	81416100744	407.11097	591
81416100226	407.00226	556	81416100744	407.11097	609
81416100227	407.00227	565	81416102881	407.00317	557
81416100228	407.00228	565	81416102881	407.00317	566
81416100229	407.00303	557	81416102882	407.00316	557
81416100230	407.00304	557	81416102882	407.00316	566
81416100231	407.00301	566	81416102900	407.00318	534
81416100232	407.00302	566	81416104066	407.00002	545
81416100305	407.00305	566	81416104067	407.00001	545
81416100306	407.00306	566	81416104071	407.00003	545
81416100307	407.00307	556	81416104072	407.00004	545
81416100308	407.00308	556	81416104114	407.04121	548
81416100312	407.00304	557	81416105376	407.05455	552
81416100313	407.00303	557	81416105451	407.00309	575
81416100314	407.00302	566	81416105453	407.05453	552
81416100315	407.00301	566	81416105454	407.05454	552
81416100333	407.25291	534	81416105507	407.00311	575
81416100334	407.25292	534	81416105508	407.00310	575
81416100342	407.25292	534	81416105597	407.00311	575
81416100343	407.25291	534	81416105598	407.00310	575
81416100352	407.25290	534	81416105599	407.00311	575
81416100353	407.25190	534	81416105600	407.00310	575
81416100359	407.25190	534	81416105664	407.00309	575
81416100361	407.15190	582	81416105680	407.26096	538
81416100362	407.15189	582	81416105681	407.26097	538
81416100363	407.10190	598	81416105711	407.26101	539
81416100364	407.10189	598	81416105711	407.26101	542
81416100367	407.15187	583	81416105712	407.26100	539
81416100368	407.15188	583	81416105712	407.26100	542
81416100369	407.10187	599	81416105722	407.00309	575
81416100370	407.10188	599	81416105727 (81416105699)	407.26103	539
81416100375	407.00313	576	81416105727 (81416105699)	407.26103	543
81416100376	407.00312	576	81416105728 (81416105700)	407.26102	539
81416100397	407.15184	582	81416105728 (81416105700)	407.26102	543
81416100399	407.15185	582	81416105741	407.26105	539
81416100402	407.10185	598	81416105742	407.27105	543
81416100408	407.15190	582	81416105746	407.26105	539



81416105747	407.27105	543	81416505013	407.15186	557
81416106657	407.27107	543	81416505013	407.15186	567
81416106684	407.26104	539	81416505013	407.15186	576
81416106685	407.27104	543	81416850029	407.00300	535
81416106750	407.11090	608	81416850029	407.00300	583
81416106751	407.11091	608	81416850031	407.00314	556
81416106752	407.11088	608	81416850031	407.00314	566
81416106753	407.11089	608	81416850040	407.00315	557
81416106754	407.11092	608	81416850040	407.00315	566
81416106755	407.11093	608	81416850043	107.00070	553
81416106759	1107.11001	593	81416850044	107.00050	562
81416106759	1107.11001	610	81416850052	107.00070	553
81416106760	1107.11000	593	81416850059	407.25293	534
81416106760	1107.11000	610	81416850065	407.10203	582
81416106763	407.12081	591	81416850065	407.10203	599
81416106764	407.12080	591	81416850071	407.10201	599
81416106765	407.12083	591	81416850072	407.10202	599
81416106766	407.12082	591	81416850072	407.10203	582
81416106769	407.12090	592	81416850072	407.10203	599
81416106806	407.26106	539	81416850072	407.10204	582
81416106807	407.27106	543	81416850072	407.10204	599
81416106863	407.11095	608	81416850073	407.10201	599
81416130014	407.04066	546	81416850074	407.10202	599
81416130015	407.04066	546	81416850074	407.10203	582
81416130018	407.04067	546	81416850074	407.10203	599
81416130019	407.04067	546	81416850074	407.10204	582
81416130020	407.04068	546	81416850074	407.10204	599
81416130021	407.04068	546	81416850094	407.15194	582
81416130071	407.30071	548	81416850095	407.15193	582
81416130073	407.30073	548	81416850098	407.15196	582
81416130078	407.30074	549	81416850099	407.15195	582
81416130079	407.30075	549	81416850114	407.10204	582
81416130080	407.30070	549	81416850114	407.10204	599
81416130081	407.30069	549	81416850129	407.15197	583
81416135035	1007.00059	550	81416850130	407.15198	583
81416140023	407.15191	582	81416850131	407.15197	583
81416140024	407.15192	582	81416850132	407.15198	583
81416140025	407.10191	598	81416850133	407.10197	599
81416140026	407.10192	598	81416850134	407.10196	599
81416140027	407.15191	582	81416850135	407.10197	599
81416140028	407.15192	582	81416850136	407.10196	599
81416140074	407.11104	609	81418600058	1007.00058	550
81416140075	407.11103	609	81418600144	1007.00011	558
81416140076	407.11094	608	81418600144	1007.00011	569
81416140077	407.12084	591	81418600144	1007.00011	584
81416140078	407.12088	592	81418600144	1007.00011	600
81416140079	407.12089	592	81418606090	1007.00010	568
81416142183	407.10193	591	81429400304	407.26109	539
81416142183	407.10193	598	81473016048	2107.02082	550
81416142183	407.10193	607	81473016048	2107.02082	560
81416142184	407.10194	591	81473016048	2107.02082	572
81416142184	407.10194	598	81473016048	2107.02082	586
81416142184	407.10194	608	81473016048	2107.02082	602
81416144000	407.10198	599	81611100043	107.00043	547
81416146000	407.15200	583	81611100048	107.00068	553
81416146001	407.15199	583	81611100054	107.00068	553
81416146003	407.10199	599	81611100063	107.00068	553
81416146004	407.10200	599	81611100066	107.15001	579
81416146006	407.12085	592	81611100067	907.10181	584
81416146008	407.12084	591	81611100067	907.10181	600
81416146009	407.11096	608	81611100068	907.10180	584
81416146010	407.12085	592	81611100068	907.10180	600
81416505010	407.10195	591	81611100088	907.11180	593
81416505010	407.10195	608	81611100088	907.11180	609

ALL ITEMS MENTIONED IN OUR CATALOGUE ARE NOT ORIGINAL PARTS BUT PERFECTLY INTERCHANGEABLE WITH THEM.

GOVERNING LEGISLATIONS FOR THE SALE OF OUR PRODUCTS DIFFER IN EACH COUNTRY.

INFRINGEMENTS, IF ANY, OF LOCAL LEGISLATIONS ARE RESPONSIBILITY OF THE RETAILER IN THE COUNTRY OF FINAL DISTRIBUTION.



81611100089	907.11181	593	81612100474	307.25210	534
81611100089	907.11181	609	81612100475	307.25211	534
81611100100	907.26171	540	81612100478	307.25212	534
81611100100	907.26171	544	81612100479	307.25213	534
81611100101	907.26170	540	81612100482	307.25206	533
81611100101	907.26170	544	81612100483	307.25207	533
81611100109	107.12100	588	81612100486	307.25208	533
81611100122 (81611100090)907.11182		593	81612100487	307.25209	533
81611100122 (81611100090)907.11182		609	81612100602	207.00198	554
81611100123 (81611100091)907.11183		593	81612100603	207.00199	554
81611100123 (81611100091)907.11183		609	81612100616	207.00194	553
81611100124 (81611100099)907.26172		540	81612100616	207.00194	579
81611100124 (81611100099)907.26172		544	81612100617	207.00195	553
81611100125 (81611100098)907.26173		540	81612100617	207.00195	579
81611100125 (81611100098)907.26173		544	81612100674	207.00202	554
81611106032	907.10182	584	81612100674	207.00202	575
81611106032	907.10182	600	81612100675	207.00203	554
81611106033	907.10183	584	81612100675	207.00203	575
81611106033	907.10183	600	81612100676	207.00202	554
81611106039	107.15001	579	81612100676	207.00202	575
81611106042	107.15001	579	81612100683	207.00201	554
81611106048	907.10182	584	81612100683	207.00201	574
81611106048	907.10182	600	81612100684	207.00200	554
81611106049	907.10183	584	81612100684	207.00200	574
81611106049	907.10183	600	81612100692	307.25210	534
81611106057	107.12100	588	81612100697	307.25209	533
81611106058	107.11100	604	81612100698	307.25208	533
81611106077	107.15001	579	81612100699	307.25207	533
81611106081	107.11100	604	81612100704	307.25206	533
81611106082	107.12100	588	81612100726	207.00196	554
81611106090	107.26100	538	81612100742	207.00192	553
81611106090	107.26100	542	81612100742	207.00192	579
81611106092	107.15001	579	81612100743	207.00193	553
81611106095	107.11100	604	81612100743	207.00193	579
81611106096	107.12100	588	81612105363	207.05363	547
81611106101	107.15001	579	81612105364	207.05364	547
81611106104	107.26100	538	81615100129	307.00129	545
81611106104	107.26100	542	81615100130	307.00130	545
81611400016	2407.00100	572	81615100225	307.00225	548
81611456004	107.11102	538	81615100226	307.00226	548
81611456004	107.11102	542	81615100229	307.00229	548
81611456004	107.11102	588	81615100230	307.00230	548
81611456004	107.11102	604	81615100271	1007.05190	558
81611456005	107.11103	538	81615100271	1007.05190	576
81611456005	107.11103	542	81615100271	1007.05190	584
81611456005	107.11103	588	81615100271	1007.05190	593
81611456005	107.11103	604	81615100273	1007.05189	569
81611500110	107.00049	562	81615100273	1007.05189	576
81611500138	107.12101	588	81615100273	1007.05189	601
81611500138	107.12101	604	81615100273	1007.05189	610
81611500147	107.26102	538	81615100274	307.25200	533
81611500147	107.26102	542	81615100275	307.25201	533
81611500172	107.26102	538	81615100276	307.25202	533
81611500172	107.26102	542	81615100277	307.25203	533
81611505066	107.00049	562	81615100280	307.00400	565
81611505068	107.00069	553	81615100280	307.00400	597
81611506050	107.00049	562	81615100280	307.00400	607
81611506051	107.00069	553	81615100284	207.00198	554
81612100368	307.25208	533	81615100285	207.00199	554
81612100369	307.25209	533	81615100288	207.00194	553
81612100382	307.25206	533	81615100288	207.00194	579
81612100383	307.25207	533	81615100311	307.00333	565
81612100462	207.06072	562	81615100311	307.00333	598
81612100462	207.06072	604	81615100311	307.00333	607



81615100312	307.00374	565	81615100406	307.00402	565
81615100312	307.00374	598	81615100406	307.00402	597
81615100312	307.00374	607	81615100406	307.00402	607
81615100323	307.15201	556	81615100408	207.00408	562
81615100323	307.15201	581	81615100409	207.00409	562
81615100323	307.15201	590	81615100427	207.00191	574
81615100331	307.00401	565	81615100429	207.00191	574
81615100331	307.00401	597	81615100468	307.00332	564
81615100331	307.00401	607	81615100468	307.00332	581
81615100331	307.00411	565	81615100468	307.00332	590
81615100331	307.00411	597	81615100468	307.00332	597
81615100331	307.00411	607	81615100468	307.00332	606
81615100332	307.00402	565	81615100470	307.00302	556
81615100332	307.00402	597	81615100470	307.00302	581
81615100332	307.00402	607	81615100470	307.00302	590
81615100333	307.00333	565	81615100471	307.00303	556
81615100333	307.00333	598	81615100471	307.00303	581
81615100333	307.00333	607	81615100471	307.00303	590
81615100344	207.00190	574	81615100472	307.00302	556
81615100345	207.00191	574	81615100472	307.00302	581
81615100346	207.00194	553	81615100472	307.00302	590
81615100346	207.00194	579	81615100473	307.00303	556
81615100348	307.15202	556	81615100473	307.00303	581
81615100348	307.15202	581	81615100473	307.00303	590
81615100348	307.15202	590	81615100474	307.00300	556
81615100351	307.15201	556	81615100474	307.00300	590
81615100351	307.15201	581	81615100474	307.00306	575
81615100351	307.15201	590	81615100475	307.00301	556
81615100360	207.00187	574	81615100475	307.00301	590
81615100363	207.00197	554	81615100475	307.00307	575
81615100364	207.00196	554	81615100476	307.00300	556
81615100366	207.00186	574	81615100476	307.00300	590
81615100368	207.00186	574	81615100476	307.00306	575
81615100374	307.00374	565	81615100477	307.00301	556
81615100374	307.00374	598	81615100477	307.00301	590
81615100374	307.00374	607	81615100477	307.00307	575
81615100380	307.15200	556	81615100490	1007.05190	558
81615100380	307.15200	581	81615100490	1007.05190	576
81615100380	307.15200	590	81615100490	1007.05190	584
81615100381	307.15203	556	81615100490	1007.05190	593
81615100381	307.15203	581	81615100536	307.00332	564
81615100381	307.15203	590	81615100536	307.00332	581
81615100389	207.00187	574	81615100536	307.00332	590
81615100391	207.00187	574	81615100536	307.00332	597
81615100393	207.00185	574	81615100536	307.00332	606
81615100395	207.00185	574	81615100552	207.00189	574
81615100400	307.00400	565	81615100552	207.00195	553
81615100400	307.00400	597	81615100552	207.00195	579
81615100400	307.00400	607	81615100553	207.00189	574
81615100401	307.00401	565	81615100553	207.00195	553
81615100401	307.00401	597	81615100553	207.00195	579
81615100401	307.00401	607	81615100554	207.00193	553
81615100401	307.00411	565	81615100554	207.00193	579
81615100401	307.00411	597	81615100555	207.00193	553
81615100401	307.00411	607	81615100555	207.00193	579
81615100402	307.00402	565	81615100558	207.00195	553
81615100402	307.00402	597	81615100558	207.00195	579
81615100402	307.00402	607	81615100562	307.25204	533
81615100405	307.00401	565	81615100563	307.25205	533
81615100405	307.00401	597	81615100564	307.25204	533
81615100405	307.00401	607	81615100565	307.25205	533
81615100405	307.00411	565	81615100570	307.25214	534
81615100405	307.00411	597	81615100573	307.25215	534
81615100405	307.00411	607	81615100587	307.00305	575

ALL ITEMS MENTIONED IN OUR CATALOGUE ARE NOT ORIGINAL PARTS BUT PERFECTLY INTERCHANGEABLE WITH THEM.

GOVERNING LEGISLATIONS FOR THE SALE OF OUR PRODUCTS DIFFER IN EACH COUNTRY.

INFRINGEMENTS, IF ANY, OF LOCAL LEGISLATIONS ARE RESPONSIBILITY OF THE RETAILER IN THE COUNTRY OF FINAL DISTRIBUTION.



81615100643	307.15203	556	81615100821	307.25201	533
81615100643	307.15203	581	81615100822	307.00332	564
81615100643	307.15203	590	81615100822	307.00332	581
81615100644	307.15202	556	81615100822	307.00332	590
81615100644	307.15202	581	81615100822	307.00332	597
81615100644	307.15202	590	81615100822	307.00332	606
81615100704	307.00400	565	81615100823	307.00332	564
81615100704	307.00400	597	81615100823	307.00332	581
81615100704	307.00400	607	81615100823	307.00332	590
81615100705	307.00411	565	81615100823	307.00332	597
81615100705	307.00411	597	81615100823	307.00332	606
81615100705	307.00411	607	81615100824	307.00400	565
81615100735	307.15201	556	81615100824	307.00400	597
81615100735	307.15201	581	81615100824	307.00400	607
81615100735	307.15201	590	81615100827	307.00411	565
81615100736	307.15200	556	81615100827	307.00411	597
81615100736	307.15200	581	81615100827	307.00411	607
81615100736	307.15200	590	81615100847	307.00301	556
81615100737	307.15203	556	81615100847	307.00301	590
81615100737	307.15203	581	81615100848	307.00300	556
81615100737	307.15203	590	81615100848	307.00300	590
81615100738	307.15202	556	81615100855	307.00301	556
81615100738	307.15202	581	81615100855	307.00301	590
81615100738	307.15202	590	81615100856	307.00300	556
81615100751	307.00339	565	81615100856	307.00300	590
81615100751	307.00339	598	81615100861	307.25215	534
81615100751	307.00339	607	81615100862	307.25214	534
81615100752	307.00338	565	81615100871	307.00303	556
81615100752	307.00338	598	81615100871	307.00303	581
81615100752	307.00338	607	81615100871	307.00303	590
81615100759	307.00303	556	81615100872	307.00302	556
81615100759	307.00303	581	81615100872	307.00302	581
81615100759	307.00303	590	81615100872	307.00302	590
81615100760	307.00302	556	81615100882	307.00304	575
81615100760	307.00302	581	81615100883	307.00305	575
81615100760	307.00302	590	81615100915	307.00401	565
81615100763	307.00302	556	81615100915	307.00401	597
81615100763	307.00302	581	81615100915	307.00401	607
81615100763	307.00302	590	81615100916	307.00402	565
81615100770	307.00304	575	81615100916	307.00402	597
81615100771	307.00305	575	81615100916	307.00402	607
81615100799	307.00335	565	81615100936	307.00304	575
81615100799	307.00335	597	81615100941	307.25201	533
81615100799	307.00335	607	81615100942	307.25200	533
81615100800	307.00334	564	81615100979	307.15203	556
81615100800	307.00334	597	81615100979	307.15203	581
81615100800	307.00334	606	81615100979	307.15203	590
81615100801	307.00333	565	81615100980	307.15202	556
81615100801	307.00333	598	81615100980	307.15202	581
81615100801	307.00333	607	81615100980	307.15202	590
81615100802	307.00374	565	81615105161	207.05161	547
81615100802	307.00374	598	81615105162	207.05162	547
81615100802	307.00374	607	81615105163	207.05163	547
81615100803	307.00337	565	81615105164	207.05164	547
81615100803	307.00337	597	81615105187	1007.05187	536
81615100803	307.00337	607	81615105187	1007.05187	558
81615100804	307.00336	565	81615105187	1007.05187	569
81615100804	307.00336	597	81615105187	1007.05187	600
81615100804	307.00336	607	81615105187	1007.05187	610
81615100810	307.25204	533	81615110001	1007.05188	536
81615100811	307.25205	533	81615110001	1007.05188	558
81615100812	307.25202	533	81615110001	1007.05188	569
81615100813	307.25203	533	81615110001	1007.05188	576
81615100820	307.25200	533	81615110001	1007.05188	600



81615110001	1007.05188	610	81626456053	1907.25001	578
81616906051	1707.00607	560	81626806142	1707.00604	540
81616906051	1707.00607	571	81626806142	1707.00604	544
81616906051	1707.00607	577	81626806142	1707.00604	594
81616906051	1707.00607	586	81626806142	1707.00604	610
81616906051	1707.00607	594	81626806143	1707.00605	540
81616906051	1707.00607	610	81626806143	1707.00605	544
81616906056	1707.00608	560	81626806143	1707.00605	594
81616906056	1707.00608	572	81626806143	1707.00605	610
81616906056	1707.00608	578	81626906030	1707.00606	560
81616906056	1707.00608	586	81626906030	1707.00606	571
81616906056	1707.00608	594	81626906030	1707.00606	577
81616906056	1707.00608	611	81626906030	1707.00606	586
81624100046	907.00050	568	81626906030	1707.00606	594
81624100047	907.00051	568	81626906030	1707.00606	602
81624100048	907.00048	568	81626906030	1707.00606	610
81624100049	907.00049	568	81626906031	1707.00607	560
81624100063	907.00063	550	81626906031	1707.00607	571
81624100064	907.00064	550	81626906031	1707.00607	577
81624100181	907.25103	536	81626906031	1707.00607	586
81624100182	907.25102	536	81626906031	1707.00607	594
81624100183	907.25101	535	81626906031	1707.00607	610
81624100184	907.25100	535	81626906045	1707.00609	560
81624100185	907.25101	535	81626906045	1707.00609	572
81624100186	907.25100	535	81626906045	1707.00609	578
81624100187	907.25103	536	81626906045	1707.00609	586
81624100188	907.25102	536	81626906045	1707.00609	594
81626100020	1407.15002	558	81626906045	1707.00609	611
81626100021	1407.15001	558	81626906046	1707.00608	560
81626100023	1407.00023	569	81626906046	1707.00608	572
81626100023	1407.00023	601	81626906046	1707.00608	578
81626100024	1407.00024	569	81626906046	1707.00608	586
81626100024	1407.00024	601	81626906046	1707.00608	594
81626100040	1407.00024	569	81626906046	1707.00608	611
81626100040	1407.00024	601	81626906047	1707.00607	560
81626406055	1907.20001	572	81626906047	1707.00607	571
81626406056	1907.20000	572	81626906047	1707.00607	577
81626416067	1707.00603	560	81626906047	1707.00607	586
81626416067	1707.00603	571	81626906047	1707.00607	594
81626416067	1707.00603	585	81626906047	1707.00607	610
81626416067	1707.00603	594	81626906048	1707.00606	560
81626416067	1707.00603	610	81626906048	1707.00606	571
81626416068	1707.00602	560	81626906048	1707.00606	577
81626416068	1707.00602	571	81626906048	1707.00606	586
81626416068	1707.00602	585	81626906048	1707.00606	594
81626416068	1707.00602	594	81626906048	1707.00606	602
81626416068	1707.00602	610	81626906048	1707.00606	610
81626416080	1707.00600	559	81626906049	1707.00607	560
81626416080	1707.00600	571	81626906049	1707.00607	571
81626416080	1707.00600	585	81626906049	1707.00607	577
81626416080	1707.00600	593	81626906049	1707.00607	586
81626416080	1707.00600	610	81626906049	1707.00607	594
81626416081	1707.00601	559	81626906049	1707.00607	610
81626416081	1707.00601	571	81626906050	1707.00606	560
81626416081	1707.00601	585	81626906050	1707.00606	571
81626416081	1707.00601	593	81626906050	1707.00606	577
81626416081	1707.00601	610	81626906050	1707.00606	586
81626456052	1907.25000	536	81626906050	1707.00606	594
81626456052	1907.25000	560	81626906050	1707.00606	602
81626456052	1907.25000	572	81626906050	1707.00606	610
81626456052	1907.25000	578	81626906052	1707.00606	560
81626456053	1907.25001	536	81626906052	1707.00606	571
81626456053	1907.25001	560	81626906052	1707.00606	577
81626456053	1907.25001	572	81626906052	1707.00606	586

ALL ITEMS MENTIONED IN OUR CATALOGUE ARE NOT ORIGINAL PARTS BUT PERFECTLY INTERCHANGEABLE WITH THEM.

GOVERNING LEGISLATIONS FOR THE SALE OF OUR PRODUCTS DIFFER IN EACH COUNTRY.

INFRINGEMENTS, IF ANY, OF LOCAL LEGISLATIONS ARE RESPONSIBILITY OF THE RETAILER IN THE COUNTRY OF FINAL DISTRIBUTION.



81626906052	1707.00606	594	81637306549	507.15503	583
81626906052	1707.00606	602	81637306549	507.15503	592
81626906052	1707.00606	610	81637306550	507.15502	583
81626906054	1707.00608	560	81637306550	507.15502	592
81626906054	1707.00608	572	81637306560	507.10503	599
81626906054	1707.00608	578	81637306560	507.10503	609
81626906054	1707.00608	586	81637306561	507.10502	599
81626906054	1707.00608	594	81637306561	507.10502	609
81626906054	1707.00608	611	81637306572	507.25504	535
81626906055	1707.00609	560	81637306572	507.25504	557
81626906055	1707.00609	572	81637306572	507.25504	568
81626906055	1707.00609	578	81637306573	507.25502	535
81626906055	1707.00609	586	81637306656	507.25504	535
81626906055	1707.00609	594	81637306656	507.25504	557
81626906055	1707.00609	611	81637306656	507.25504	568
81626906061	1707.00609	560	81637306660	507.25504	535
81626906061	1707.00609	572	81637306660	507.25504	557
81626906061	1707.00609	578	81637306660	507.25504	568
81626906061	1707.00609	586	81637306735	507.15512	584
81626906061	1707.00609	594	81637306736	507.15513	584
81626906061	1707.00609	611	81637310260	507.00042	567
81626906062	1707.00608	560	81637310261	507.00041	567
81626906062	1707.00608	572	81637310356	507.15507	584
81626906062	1707.00608	578	81637310356	507.15507	593
81626906062	1707.00608	586	81637316556	507.00040	567
81626906062	1707.00608	594	81637320059	507.00035	567
81626906062	1707.00608	611	81637320060	507.00036	567
81626906063	1707.00609	560	81637320061	507.00037	567
81626906063	1707.00609	572	81637320062	507.00038	567
81626906063	1707.00609	578	81637320073	507.15509	584
81626906063	1707.00609	586	81637320073	507.15509	593
81626906063	1707.00609	594	81637320074	507.15508	584
81626906063	1707.00609	611	81637320074	507.15508	593
81626906064	1707.00608	560	81637320075	507.15511	584
81626906064	1707.00608	572	81637320075	507.15511	593
81626906064	1707.00608	578	81637320076	507.15510	584
81626906064	1707.00608	586	81637320076	507.15510	593
81626906064	1707.00608	594	81637330049	507.30049	550
81626906064	1707.00608	611	81637330067	504.99026	549
81637010044	707.10202	568	81637330069	501.89373	549
81637010044	707.10202	600	81637330075	504.99026	549
81637010047	707.15300	557	81637330116	507.25503	535
81637010048	707.10200	568	81637336006	507.36006	546
81637010048	707.10200	600	81637336033	507.00033	567
81637010055	707.25100	535	81637336049	507.00033	567
81637010057	707.10201	568	81637336057	507.00034	567
81637010057	707.10201	600	81637336061	507.25500	535
81637010058	707.25100	535	81637336062	507.25501	535
81637306305	507.07750	549	81637336067	507.25500	535
81637306307	507.07900	549	81637336068	507.25501	535
81637306316	507.07750	549	81637336071	507.15504	583
81637306430	507.00031	567	81637336071	507.15504	592
81637306432	507.00032	567	81637336072	507.15506	583
81637306449	507.25502	535	81637336072	507.15506	592
81637306512	507.15515	568	81637336073	507.15505	583
81637306513	507.15514	568	81637336073	507.15505	592
81637306529	507.10501	599	81664100155	207.00201	554
81637306529	507.10501	609	81664100155	207.00201	574
81637306531	507.10500	599	81664100162	207.00200	554
81637306531	507.10500	609	81664100162	207.00200	574
81637306533	507.15501	583	81664100172	207.06084	555
81637306533	507.15501	592	81664100172	207.06084	563
81637306534	507.15500	583	81664100172	207.06084	580
81637306534	507.15500	592	81664100172	207.06084	589



81664100172	207.06084	595	81664100462	207.06091	606
81664100172	207.06084	605	81664100463	207.06092	555
81664100173	207.06085	555	81664100463	207.06092	564
81664100173	207.06085	563	81664100463	207.06092	580
81664100173	207.06085	580	81664100463	207.06092	589
81664100173	207.06085	589	81664100463	207.06092	596
81664100173	207.06085	595	81664100463	207.06092	606
81664100173	207.06085	605	81664100484	207.06095	554
81664100181	207.00203	554	81664100484	207.06095	563
81664100181	207.00203	575	81664100484	207.06095	575
81664100184	207.06080	563	81664106086	207.06076	554
81664100185	207.06081	563	81664106086	207.06076	563
81664100204	207.06078	562	81664106086	207.06076	579
81664100205	207.06079	562	81664106086	207.06076	589
81664100226	207.06076	554	81664106086	207.06076	595
81664100226	207.06076	563	81664106086	207.06076	605
81664100226	207.06076	579	81664106086	207.06086	555
81664100226	207.06076	589	81664106086	207.06086	563
81664100226	207.06076	595	81664106086	207.06086	580
81664100226	207.06076	605	81664106086	207.06086	589
81664100226	1007.00001	572	81664106086	207.06086	596
81664100293	207.06083	555	81664106086	207.06086	605
81664100293	207.06083	563	81664106573	207.06089	580
81664100293	207.06083	580	81664106573	207.06089	596
81664100293	207.06083	589	81664106573	207.06089	606
81664100293	207.06083	595	81664106574	207.06090	580
81664100293	207.06083	605	81664106574	207.06090	596
81664100294	207.06082	555	81664106574	207.06090	606
81664100294	207.06082	563	81664106599	207.06093	581
81664100294	207.06082	580	81664106599	207.06093	589
81664100294	207.06082	589	81664106599	207.06093	596
81664100294	207.06082	595	81664106599	207.06093	606
81664100294	207.06082	605	81664106606	207.06077	554
81664100306	207.06080	563	81664106606	207.06077	563
81664100307	207.06081	563	81664106606	207.06077	580
81664100308	207.06078	562	81664106606	207.06077	589
81664100309	207.06079	562	81664106606	207.06077	595
81664100310	207.06080	563	81664106606	207.06077	605
81664100311	207.06081	563	81664106606	207.06087	555
81664100312	207.06078	562	81664106606	207.06087	564
81664100313	207.06079	562	81664106606	207.06087	580
81664100352	207.05080	547	81664106606	207.06087	589
81664100353	207.05081	547	81664106606	207.06087	596
81664100360	207.00202	554	81664106606	207.06087	605
81664100360	207.00202	575	81664106607	207.06099	555
81664100361	207.00203	554	81664106607	207.06099	564
81664100361	207.00203	575	81664106607	207.06099	581
81664100362	207.00201	554	81664106607	207.06099	590
81664100362	207.00201	574	81664106607	207.06099	596
81664100363	207.00200	554	81664106607	207.06099	606
81664100363	207.00200	574	81664106607	207.06100	555
81664100364	207.00202	554	81664106607	207.06100	564
81664100364	207.00202	575	81664106607	207.06100	581
81664100365	207.00203	554	81664106607	207.06100	590
81664100365	207.00203	575	81664106607	207.06100	597
81664100366	207.00201	554	81664106607	207.06100	606
81664100366	207.00201	574	81664106608	207.06097	555
81664100367	207.00200	554	81664106608	207.06097	564
81664100367	207.00200	574	81664106608	207.06097	575
81664100462	207.06091	555	81664106608	207.06097	581
81664100462	207.06091	564	81664106608	207.06097	590
81664100462	207.06091	580	81664106608	207.06097	596
81664100462	207.06091	589	81664106608	207.06097	606
81664100462	207.06091	596	81664106612	207.06096	554

ALL ITEMS MENTIONED IN OUR CATALOGUE ARE NOT ORIGINAL PARTS BUT PERFECTLY INTERCHANGEABLE WITH THEM.

GOVERNING LEGISLATIONS FOR THE SALE OF OUR PRODUCTS DIFFER IN EACH COUNTRY.

INFRINGEMENTS, IF ANY, OF LOCAL LEGISLATIONS ARE RESPONSIBILITY OF THE RETAILER IN THE COUNTRY OF FINAL DISTRIBUTION.



81664106612	207.06096	563
81664106612	207.06096	575
81664106612	207.06096	579
81664106612	207.06096	588
81664106612	207.06096	595
81664106612	207.06096	605
81664106625	207.06088	580
81664106625	207.06088	596
81664106625	207.06088	605
81664200125	1007.10102	558
81664200125	1007.10102	569
81664200125	1007.10102	576
81664200234	1007.10100	558
81664200234	1007.10100	569
81664200234	1007.10100	576
81664200237	1007.10101	558
81664200237	1007.10101	569
81664200237	1007.10101	576
81664400187	207.06098	564
81664400189	207.06094	588
81664400189	207.06094	604
81664400192	207.06077	554
81664400192	207.06077	563
81664400192	207.06077	580
81664400192	207.06077	589
81664400192	207.06077	595
81664400192	207.06077	605
81664400192	207.06100	555
81664400192	207.06100	564
81664400192	207.06100	581
81664400192	207.06100	590
81664400192	207.06100	597
81664400192	207.06100	606
81664400192	1001.14951	560
81664400192	1001.14951	572
81664400192	1001.14951	602
81960020466	407.00319	557
81960020466	407.00319	566
81960020491	407.00319	557
81960020491	407.00319	566
81960020497	407.00319	557
81960020497	407.00319	566
81970060002	2407.00101	560
81970060002	2407.00101	586
81970060003	2407.00103	561
81970060003	2407.00103	586
81970060027	2407.11100	602
81970060028	2407.11101	602
81970060029	2407.12100	586
81970060030	2407.12101	586
81970060036	2407.00102	560
81970060036	2407.00102	586
81971006079	1707.00599	550
81971006098	1707.00599	550
85416104002	407.02090	532
85416104003	407.02091	532
85612100003	207.02001	532
85612100004	207.02000	532
85612100007	207.02003	532
85612100008	207.02002	532
85612300028	207.02004	532





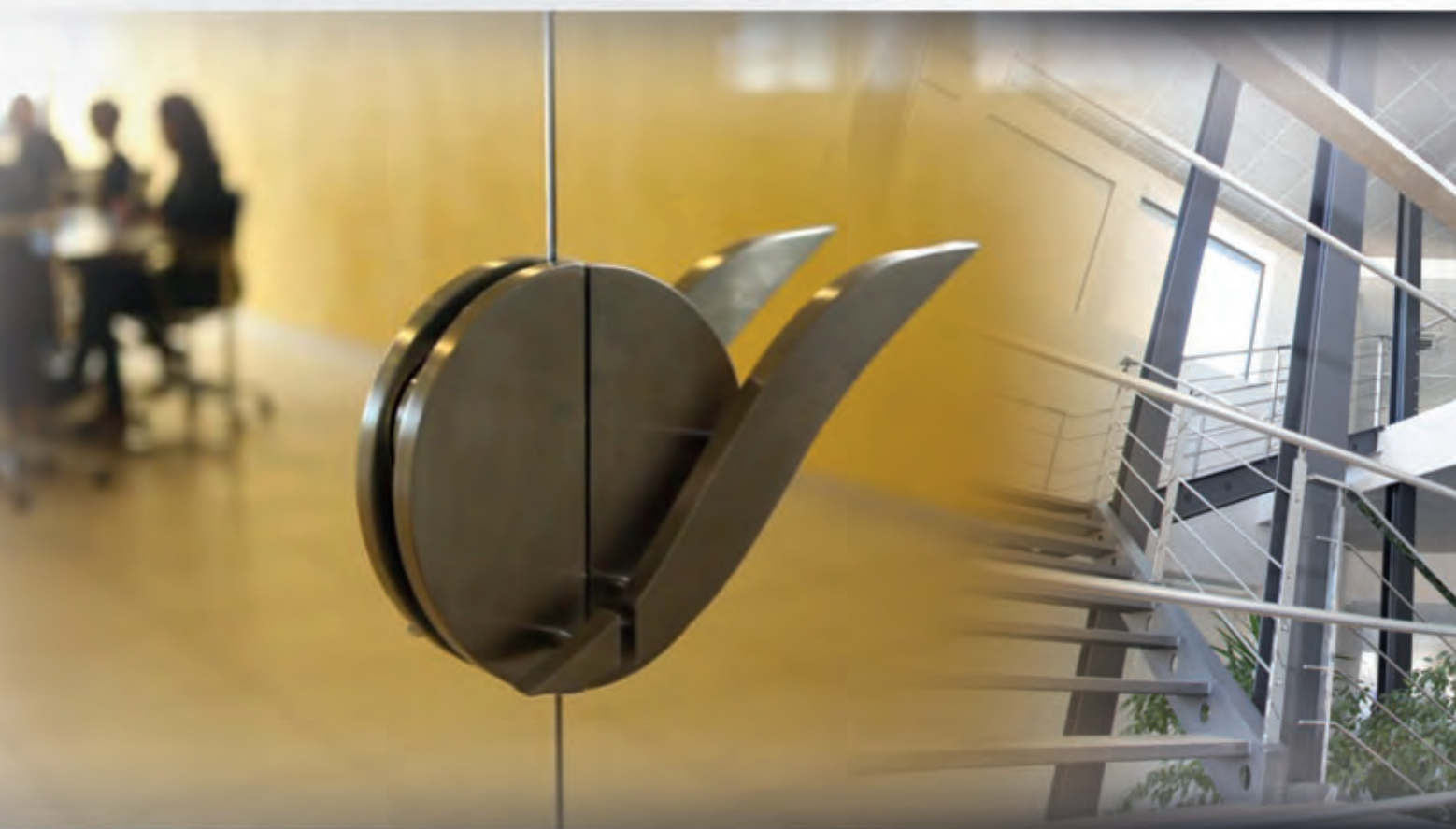





Cos.Pel. Srl

Via Venezia, 58 | 12084 Mondovì (CN)

Tel +39 0174 698502 | Fax +39 0174 698501

www.cospel.it | cospel@cospel.it | export@cospel.it