

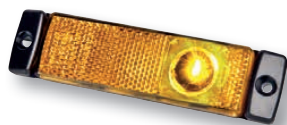

## TRUCK & TRAILER



## Lights & cabling





# Contents



## Contents

### Technical Information

EasyConn cabling and lighting system for 24-V trailers	Page	4–5
The EasyConn system	Page	6–7
The connector system – the technology behind it.	Page	8
EasyConn connector system	Page	9
LED-light failure check and correct electrical connection	Page	10–13

### Front Lighting

Product highlight	Page	14–15
Position lights	Page	16–17

### Side Lighting

Product highlight	Page	18–19
Side marker lights	Page	20–21

### Rear Lighting

Product highlight	Page	22–23
Combination rear lights	Page	24–28
Multi-function lights	Page	29–39
Clearance lights	Page	40–43
License plate lights	Page	44–45
Reflex reflectors	Page	46–47
Reversing spotlights	Page	48
Accessories	Page	49

### Cabling

Adapters, cables, cable sets, distributors, service sets and spare parts	Page	50–59
--	------	-------

### Type Approval Numbers

Overview of front lighting	Page	60
Overview of side lighting	Page	60
Overview of rear lighting	Page	60–63

# The EasyConn cabling and lighting system for 24-V trailers

The EasyConn lighting and cabling system has been especially developed for 24-V trailers. It covers almost all imaginable application cases on a 24-V trailer. With this, HELLA has created an inexpensive system alternative. In future, implement flexible cabling for 24-V trailers with the modular "EasyConn" cabling and lighting system from HELLA.

## The cabling

EasyConn is particularly cost-efficient and flexible: This means that you no longer have to fit a distributor for the cabling, but you can do so at any time if required. For example, cable cross-sections in alignment with market requirements make it possible to fit additional work lights using the standard system. The system is approved for vehicles according to GGVS / ADR.

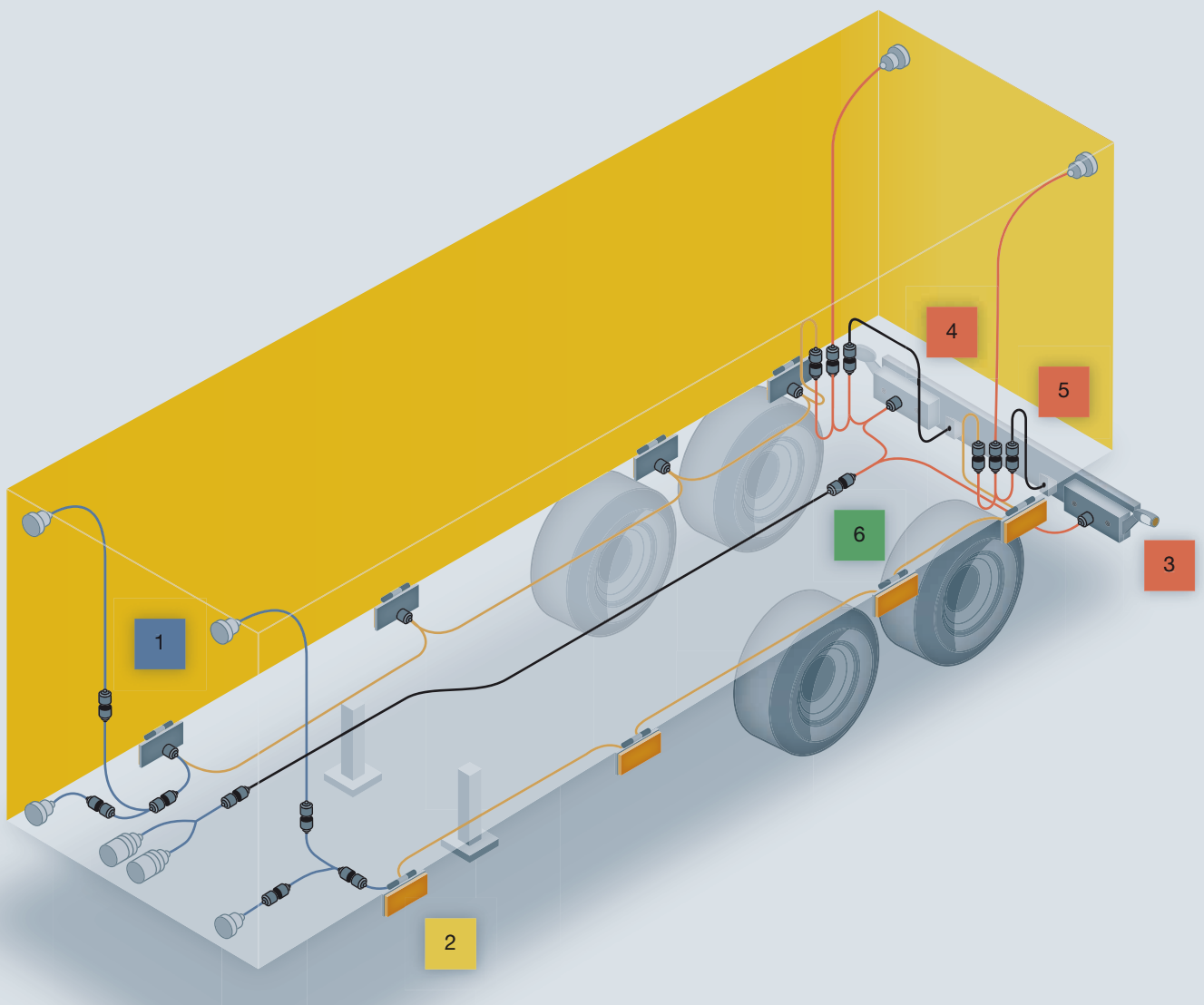

## Explanation of colouring and symbols

- Blue  
Lighting and cabling equipment in the front section
- Yellow  
Lighting and cabling equipment in the side section
- Red  
Lighting and cabling equipment in the rear section

- Green  
Cabling
- Grey  
Accessories and spare parts

GGVS = **G**efahr**G**ut**V**erordn**u**ng**S**traße  
 ADR = **A**ccord européen relatif au transport international  
 des marchandises **d**angereuses par route

1



### Position light

The tried and tested position lights come with a cable and EasyConn male connector housing for connecting to the EasyConn system. Also available with a blade terminal and quick link cabling.

2



### Side marker light

The EasyConn side marker lights can be fitted directly or using a bracket. Connection is possible via a cable with EasyConn female connector housing, blade terminal or quick link cabling.

3



### Clearance light

The EasyConn clearance light with rubber arm and side marker light guarantees positioning precision, flexibility and impact resistance.

4



### Combination rear light

The EasyConn combination rear lights with central plug are available in the following versions: Standard, with side marker lights including reflex reflector or with rubber arm, central plug or cable gland.

5



### License plate light

The license plate light is provided with a cable with EasyConn female connector housing for connecting to the EasyConn system. Also available with a blade terminal.

6



### Cabling

The EasyConn cabling system is made up of front and rear adapters, main supply cables, SMLR chains and auxiliary adapters. Upon request, distributors e.g. to cover special functions, can be integrated in this distributorless system.

# EasyConn system

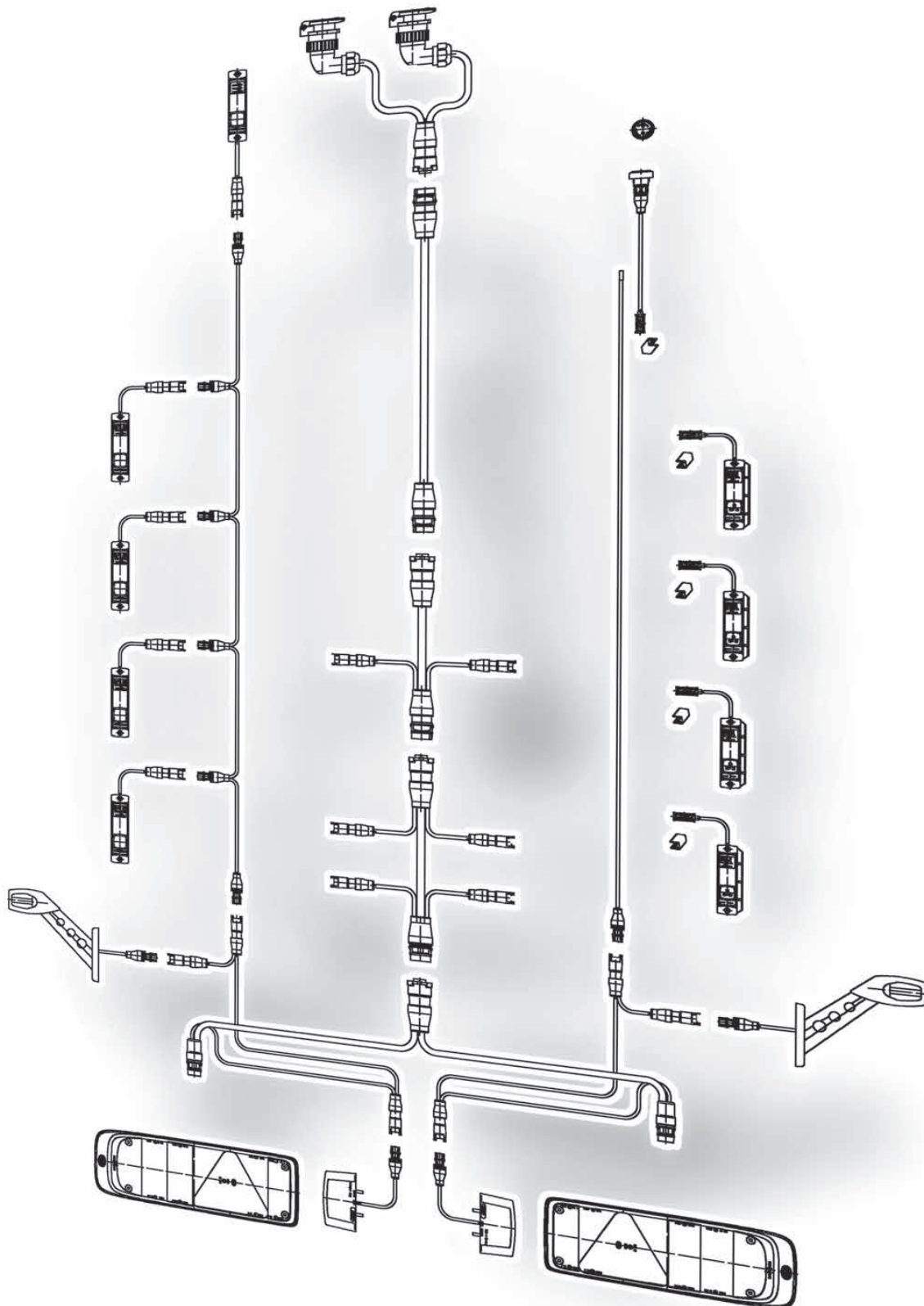

It is possible to expand for lighting and special functions only by using the extra intermediate adapter. As the number of interfaces increases, so does the danger of the entire lighting system failing. A subsequent expansion of the system is only possible under certain circumstances.

If improperly executed, each intervention increases the failure probability of the entire system. The system that has been used so far does not intend for a separation of the light functions of special lighting systems and additional functions as specified by the StVZO.

# EasyConn NextGeneration system

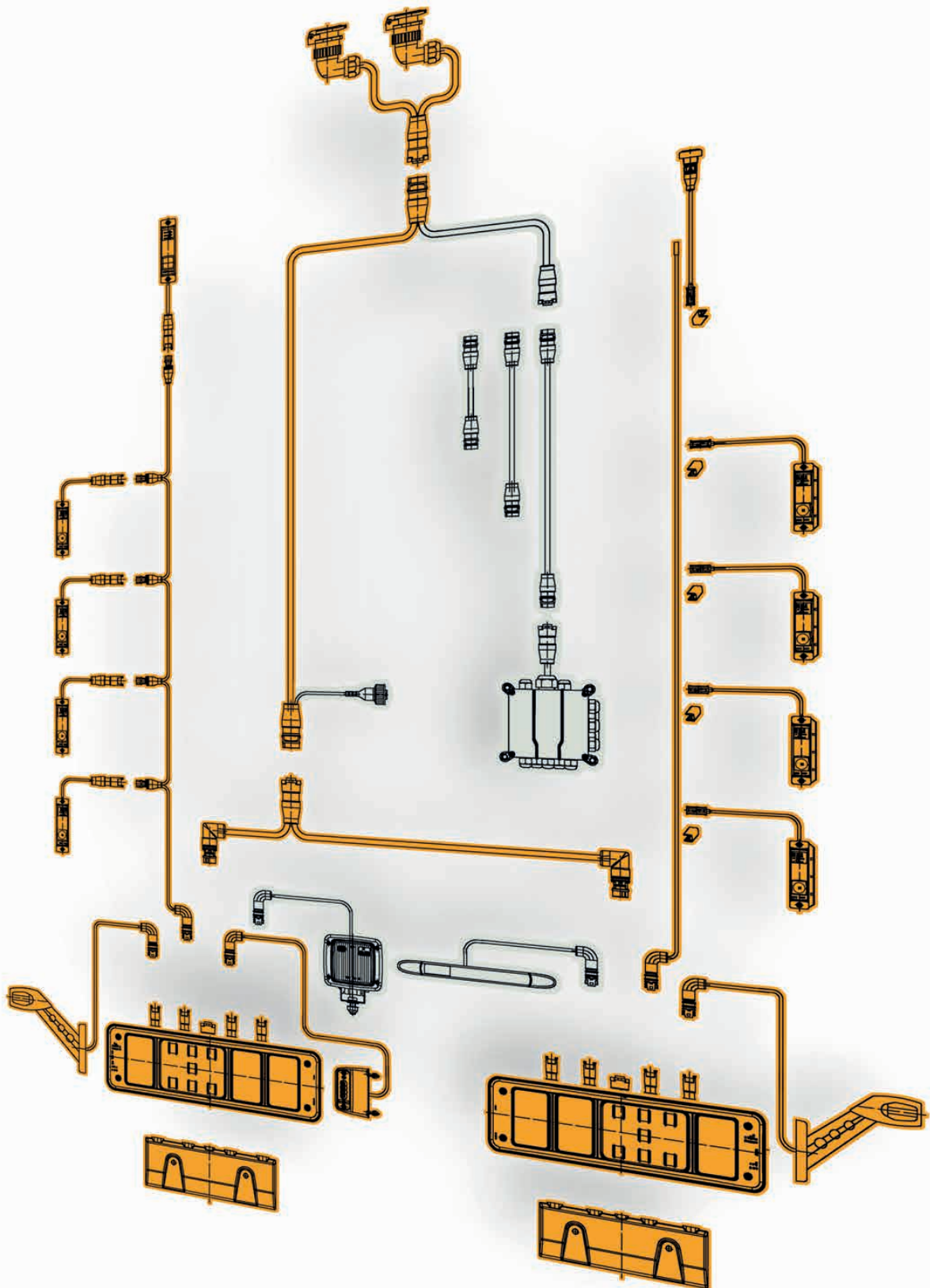

The modular hybrid combination rear lights undertake the distributor function for all light functions required by the StVZO. In doing so, as specified by the StVZO, a separate distributor circuit strictly separates the light functions from other special lighting systems and additional functions.

The advantages: A cost-effective, easy to install and modularly structured lighting system as well as a simple subsequent expansion of the standard system with additional EasyConn components and other lighting and special functions. The fail-safe operation is very high.

# The connector system – the technology behind it.

## The connectors

The EasyConn connector system comprises 2-, 7- and 15-pin male and female connector housings. Their diameters have been reduced considerably – for even easier mounting on the trailer.

In future, you can implement flexible cabling for 24-V trailers with the modular "EasyConn" cabling and lighting system from HELLA.

## Section of a 2-pin EasyConn connector

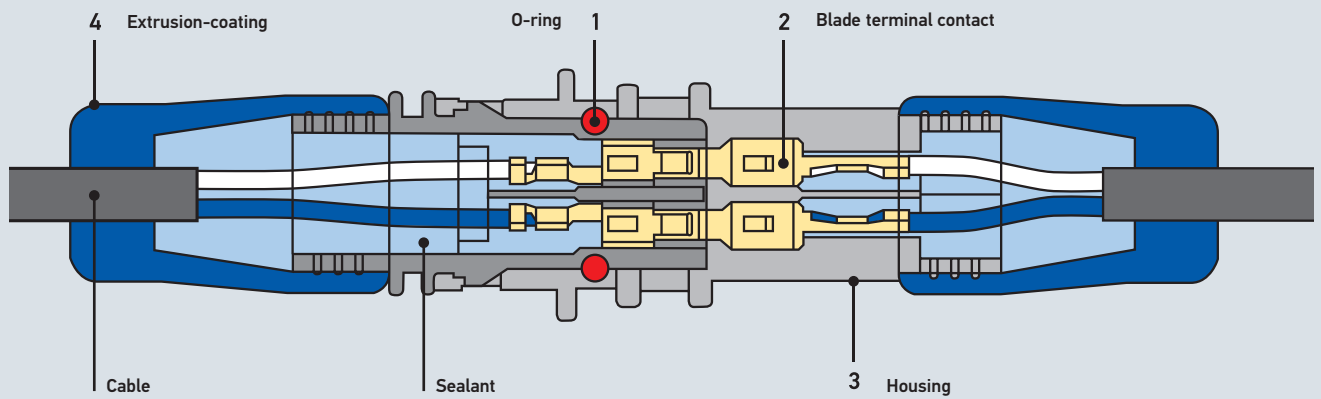

**1 O-ring**  
The o-rings on the female connector housing are replaceable and have good sealing properties.

**2 Contacts**  
A 2.8 mm blade terminal system is used for contacting purposes. The flat receptacles have an additional steel spring for a safe contact. The load is around 25 amps (constant current).

**3 Housing**  
The housing is made of impact-proof plastic (PBT) and is cast using a low-pressure method which means the contacts are fixed floating.

**4 Extrusion-coating**  
The housing as well as the sheathed cable will be extrusion-coated with TPE in a second work cycle. This provides double safety.



2 1 3 4



The plug-in connections have been tested to protection class **IP6K9K** and are guaranteed to be absolutely airtight.

**6K** = dust-tight, **9K** = resistant to high-pressure / steam cleaning



# EasyConn connector system: easy, process-safe connection of all components.



## 2-pin connector

The 2-pin. EasyConn connector and female connector housing enables, for example, SMLR, position and clearance lights as well as 2-pin additional functions to be connected.



## 7-pin connector

Combination rear lights will be connected to the EasyConn system by means of the 7-pin connector and female connector housing.



## 15-pin connector

The 15-pin EasyConn connector and female connector housing connect the front adapter, HVL and rear adapter with each other.

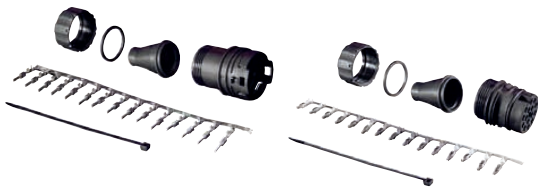

## Service sets

2-, 7- and 15-pin service sets are available for integrating customer-specific lights or sub-assemblies in the EasyConn system as well as for retrofitting EasyConn components.



- Simply connect the coupling to the flat cable.
- Fix with the clamping element.
- Press together with the mounting pliers.
- Finished.

## Quick link cabling: flexible and secure assembly

The quick link cabling system offers a further contacting option which is characterised by its fast and uncomplicated assembly. Lights fitted with HELLA quick link cabling are made up of a cable with a coupling. The cables are provided in differing lengths as required. These lights can contact a 2-wire flat cable to any position. They can also be used in the transport of hazardous goods (GGVS / ADR).





# Functional safety

Vehicle pool managers and drivers expect functional safety without any ifs, ands or buts. In other words, vehicle components with a high quality standard and long service life. HELLA LED lights meet these requirements. They have been developed and produced according to the strictest quality standards. HELLA tests their everyday driving suitability in the toughest series of simulations: Stress factors such as temperature, moisture and current feed lead to internationally recognised **AECQ** qualification in long-term reliability tests. But this standard is not sufficient for HELLA. The LEDs are therefore subjected to thousands of hours of additional stress and service life testing. That is why, in addition to the visual features, the electrical and thermal features are decisive for HELLA.

## LED-light failure check and correct electrical connection

- Operation of LED lights / LED headlights with AC voltage or synchronised DC voltage is not permitted. The light's individual functions may only be operated with an on-board fuse of max. 3 A, the individual functions of a headlight with an on-board fuse of max. 10 A (vehicle-specific 5 A). In case of an on-board current limit amounting to the above specification due to the on-board control unit, there is no need for an additional fuse for the lights. Due to the low watt output of LED lights, which are distinctly different from a bulb version, problems can arise in bulb failure control when operating traction vehicles.

As it is required by law to check the direction indicators, we recommend operating the light only in conjunction with a direction indicator control unit, LED flasher unit, or a simulation device for cold checking. Furthermore, some traction vehicles detect other light functions. This represents a vehicle comfort function that is not required by law and does not exempt the driver from his obligation to visually inspect the lighting equipment. Even in this case, low outputs can lead to misdiagnoses (instrument panel in the cab shows a light failure even though it is working fine).

- Should misdiagnoses, as described above, occur while operating your traction vehicle, please contact the traction vehicle manufacturer.

# The right solution for your vehicle electronics

## CONVERSION VEHICLE

Start →

Is a flasher relay installed in the vehicle?

Yes →

No

Turn on the vehicle ignition and remove the bulb of a direction indicator without pressing the signal switch.

Any failure of the flasher unit is displayed.

Yes →

No

Press the signal switch

Any failure of the flasher unit is displayed.

Yes →

No

Vehicle not ECE-compliant

## TRAILER →



**Solution 1:**  
LED flasher unit



**Solution 2:**  
Simulation device for cold checking

	12 V	24 V
Operating voltage	10 – 15 V	18 – 32 V
Functional voltage	11 – 14 V	20 – 28 V
Operating temperature	-40°C to 85 °C	-40°C to 85 °C
Protection class	IP 53 (contacts below)	IP 53 (contacts below)
<b>LED flasher units 3+1</b>		
3 Direction indicators on the vehicle / traction vehicle 1 Direction indicator on optional trailer	<b>4DW 009 492-111</b>	<b>4DW 009 492-011</b>
<b>LED flasher units 2+1</b>		
2 Direction indicators on the vehicle / traction vehicle 1 Direction indicator on optional trailer	<b>4DM 009 492-101</b>	<b>4DM 009 492-001</b>

	12 V	24 V
Operating voltage	9 – 16 V	18 – 32 V
Nominal current	1.5 A	1.5 A
Operating temperature	-40°C to 85 °C	-40°C to 85 °C
Protection class	IP 54 (contacts below)	IP 54 (contacts below)
<b>Simulation device</b>		
for cold checking	<b>5DS 009 602-011</b>	<b>5DS 009 602-001</b>

**Safe conversion to LED direction indicators using patented HELLA electronics**

HELLA supplies electronic ballasts for HELLA LED direction indicators which makes it possible to implement the indicator failure display in a diverse range of vehicles. This is necessary if the vehicle manufacturer does not guarantee direction indicator bulb failure control via the vehicle's electrical system. The method is patented by HELLA. There are currently three different ballasts and several different LED flasher unit types available.

**Solution 1:**

Replace the existing device with an LED flasher unit from HELLA with ISO pin basis



One flasher unit is required per vehicle. Any possible combination of bulbs and HELLA LED direction indicators is permitted: from a full package with bulbs through mixed versions to a full package with LED lights. Bulbs or HELLA LED direction indicators are also permitted on trailers.

**Solution 2:**

With simulation device for cold checking



One simulation device is required per LED light.

**Solution 3:**

By LED direction indicator control unit

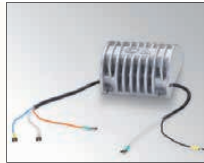

Two LED direction indicators can be monitored per vehicle using one simulation device. (Only one simulation device can be used per vehicle.)

**Solution 3:**

By LED direction indicator control unit

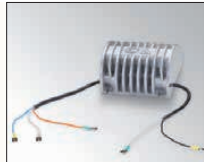

Failure pulse

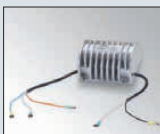

**Solution 3:**  
Direction indicator control unit



**Solution 4:**  
Light control device with integrated failure pulse

	<b>24 V</b>
Operating voltage	18–32 V
Polarity reversal protection voltage	- 28 V
On-board voltage input Flasher unit left / right	24 V
Operating temperature	-40°C to 50 °C
Extended operating temperature*	-40°C to 80 °C
Storage temperature	-40°C to 90 °C
With flat receptacles	<b>5DS 009 552-011</b>
For EasyConn connectors	<b>5DS 009 552-001</b>

In future, light control devices can query the failure pulse. Therefore, interim solutions 1 - 3 will not be necessary and communication will take place directly with the direction indicators.

\* Above 50°C, simulation of the bulb is deactivated for thermal reasons.





## Position lights in LED technology

The extensive HELLA range offers the correct position light for every commercial vehicle. You can rely on the efficient LED lights by HELLA. Two selected product examples:

### **LED Position light with reflex reflector - mounted**

The light, with its white LED and a black, robust housing, is available in three variants and is suitable for either horizontal or vertical mounting.



#### **Mounted variant**

→ Information on page 16

### **LED Position light with reflex reflector - mounted**

The LED position light is suitable for horizontal or vertical installation. Further features: Clear lens, a white LED and black cover cap for the screw heads.



#### **Installation variant**

→ Information on page 16

# Position lights



## LED position light with reflex reflector

for horizontal and vertical mounting, with 1 white LED, white light, black housing and black plastic base plate. With horizontal mounting, the LED field must point to the outer vehicle edge. For vertical mounting, the LED field may point upwards or downwards. The light is fixed using the lateral mounting holes (for B4.2 screws) or using a bracket (must be ordered separately). Protection class IP 6K9K.

with 500 mm potted cable **2PG 008 645-971\***

with 5000 mm potted cable **2PG 008 645-961\***

with 2-pin EasyConn male connector housing and cellular rubber seal for the light, EasyConn connector and 2 mounting holes.  
24 V / 0.9 W, current consumption = approx. 0.04 A

with 300 mm cable **2PG 008 645-321\***

with 1,300 mm cable **2PG 008 645-331\***

with 3,000 mm cable **2PG 008 645-341\***

with quick link coupling including clamping element for contact with a 2-wire flat cable, with cellular rubber seal for the light.  
24 V/0.9 W, current consumption = approx. 0.04 A

with 300 mm cable **2PG 008 645-631\***

with 5000 mm cable **2PG 008 645-641\***



## LED position light, installation

for horizontal or vertical installation, with 1 white LED, white light, clear lens, and black cover caps for the screw heads. Multi-voltage 10–33 V.

with 500 mm cable **2PF 959 590-202\***

with 5000 mm cable **2PF 959 590-212\***



## LED position light, mounted

for horizontal mounting, with 1 white LED, white light, clear lens and black housing. Multi-voltage 10–33 V.

with 500 mm cable **2PF 959 570-202\***

with 5000 mm cable **2PF 959 570-212\***

= ADR / GGVS tested

\* Please see the note on pages 10 - 13 regarding LED direction indicator lights and LED failure check.

☒ Refer to pages 60 - 63 for the type approval numbers.



# Position lights

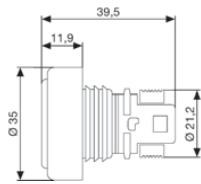

## LED position light, installation

Round installed light with 2 white LEDs, clear lens, without reflex reflector, diameter 35 mm, depth 39.5 mm, of which 11.9 mm is surface-mounted.

Black rubber housing with louvres, simple insertion in vehicles with wall thicknesses of 3 - 10 mm, 24 V / 0.9 W, 2-pin EasyConn central connector.

**2PF 340 825-001\***

Black plastic housing with 2-pin cable (2 x 0.5 mm<sup>2</sup>) 500 mm long, with 2-pin Superseal connector, light firmly bonded with WEVO adhesive, with adhesive tape for sticking to surfaces, polarity-independent, 24 V / 0.9 W

**2PF 340 825-057**

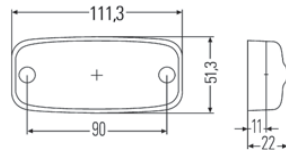

## LED position light with reflex reflector

for horizontal mounting, with 2 white LEDs, white light, white base plate, without bracket and 2 holes Ø 5,5 mm for fastening screws.

with 500 mm potted cable

**2PG 963 639-401\***

with 5000 mm potted cable

**2PG 963 639-411\***

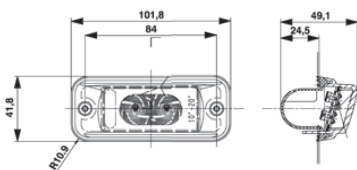

## LED position light, installation

with 2 white LEDs.

for installation position 10–20°

**2PF 009 514-001\***

for installation position 20–30°

**2PF 009 514-011\***

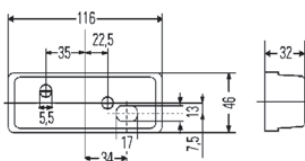

## Position light, mounted

with reflex reflector, for horizontal mounting, clear lens

without bracket

**2PG 003 748-151**







## Side marker lights in LED technology

Side marker lights for trucks and trailers contribute towards safety on the roads. As it is only these markings that make the entire vehicle easy to see even in the dark. The side marker lights from HELLA offer you longevity, a high output and a quick installation. Two selected product examples in LED technology:

### **LED side marker light with reflex reflector**

The light with two amber LEDs and a black base plate is available with or without a bracket. It is also suitable for horizontal mounting.



#### **Mounted variant**

→ Information on page 21

### **LED side marker light with reflex reflector**

The light with an amber LED and black, robust housing, is available in three variants. It is suitable for horizontal and vertical mounting using a bracket or fastening screws.

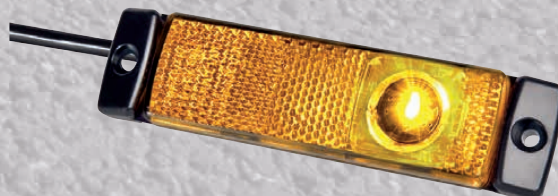

#### **Mounted variant**

→ Information on page 20

# Side marker lights

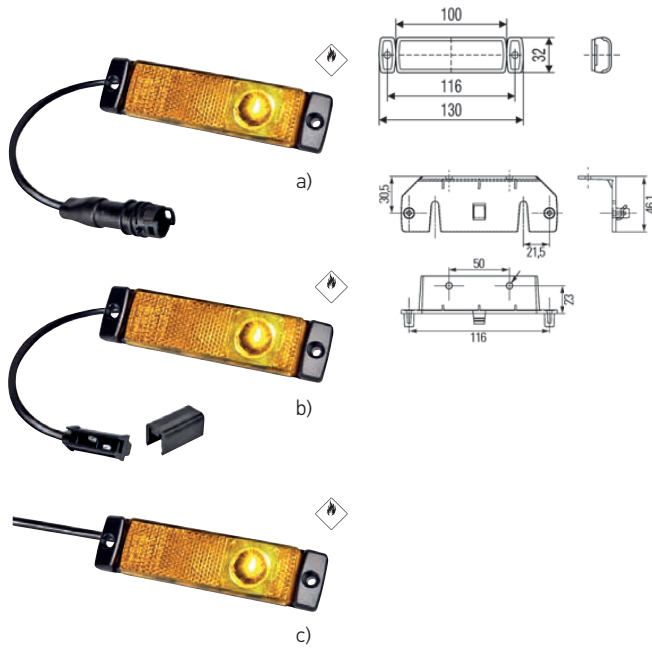

## LED side marker light with reflex reflector

for horizontal or vertical mounting, with 1 amber LED, amber lens, amber light, black housing, with cellular rubber seal for the light and 2 holes for fastening screws B4.2. Protection class IP 6K9K.

With horizontal mounting, the optical field must point to the outer vehicle edge.

### a) for horizontal mounting

with 2-pin EasyConn male connector housing

with 300 mm cable, left / right	<b>2PS 008 645-301*</b>
with 1300 mm cable, left / right	<b>2PS 008 645-311*</b>
with 2000 mm cable, left / right	<b>2PS 008 645-361*</b>

### b) for horizontal mounting

with quick link cabling for contacting a 2-wire flat cable, complete with clamping element, bidirectional.

with 300 mm cable, left / right	<b>2PS 008 645-611*</b>
with 1300 mm cable, left / right	<b>2PS 008 645-621*</b>

### c) Mounting

24 V / 1.2 W, current consumption = approx. 0.05 A

horizontal mounting with 1500 mm cable, without connector	<b>2PS 008 645-001*</b>
vertical mounting with 1500 mm cable	<b>2PS 008 645-991*</b>

### Accessories

Bracket with fastening screws	<b>8HG 160 409-002</b>
-------------------------------	------------------------

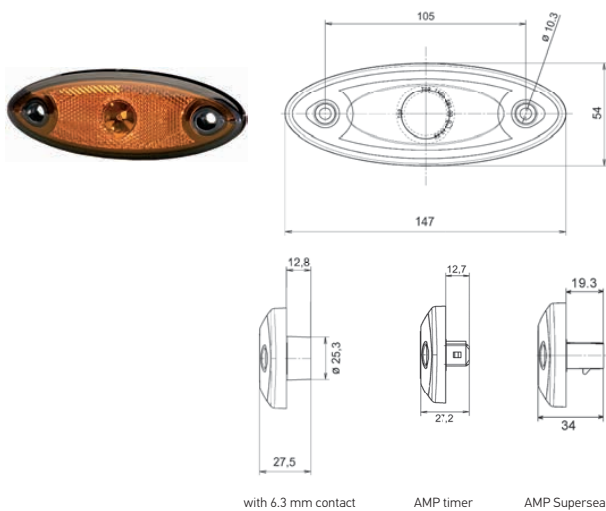

with 6.3 mm contact      AMP timer      AMP Superseal

## LED side marker light

for horizontal and vertical mounting, black housing, mounting with screw attachment with 2 screws of diameter 6 mm.

24 V, with 6.3 mm blade terminal	<b>2PS 343 690-031</b>
24 V, with AMP timer	<b>2PS 343 690-411</b>
24 V, with AMP Superseal	<b>2PS 343 690-621</b>

= ADR / GGVS tested

\* Please see the note on pages 10 - 13 regarding LED direction indicator lights and LED failure check. Refer to pages 60 - 63 for the type approval numbers.

# Side marker lights

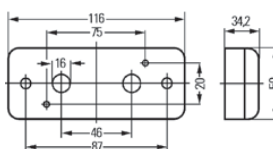
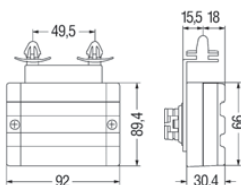
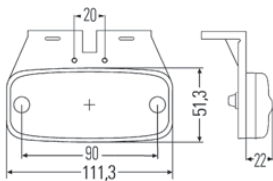
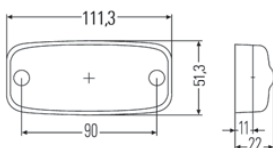
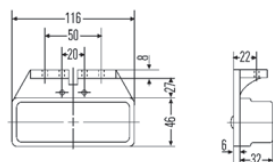
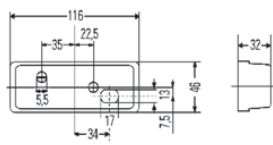

## Side marker light with reflex reflector

for mounting, with inserted seal

without bracket

2PS 003 748-121

with reinforcement plate and bracket

2PS 003 748-161



## LED side marker light with reflex reflector

for horizontal mounting, with 2 amber LEDs, amber lens, amber light, black base plate.

without bracket, with 500 mm cable

2PS 963 639-011\*

with bracket, angled towards the rear, with 500 mm cable

2PS 963 639-071\*



## Side marker light

for horizontal mounting, with clip angle across / towards the front, with 24 V bulb, contacting using indentation clamping connection.

2PS 340 000-011



## Side marker light

for horizontal or vertical mounting

with 2 PG screw connections

2PS 963 959-001

with rubber bracket

2PS 963 959-011



## EasyConn NextGeneration

The modular multi-function combination rear lights (24 V) with tail stop light in LED technology leaves nothing to be desired when it comes to customer needs. All additional optional functions can be selected with bulbs or LED technology. The patented lens is replaceable.

Individual parts and modules can be replaced and upgraded according to the modular principle. By combining efficient LEDs with precision lenses, the lights achieve the light distribution specified by law - and all of this with up to 67% less power in comparison with bulb lighting.

Using the HELLA-patented system for monitoring the direction indicators, the light can be used together with the HELLA 5DS 009 552-001 ballast in accordance with ECE R48. The light (also the complete LED version) is designed so that, according to the current condition, no error message is displayed in the vehicle's electrical system.

The polarity reversal protection ensures that the light is not damaged due to accidental contact of the poles. To extend the design life, all components are attuned to one another's optimal temperatures in order to avoid overloading the LEDs at high ambient temperatures. The lights are designed for the design life of a vehicle and are therefore a convincing, economic and environmental solution.



### EasyConn NextGeneration

Modular hybrid trailer lights

→ Information on page 24 and 25



# Combination rear lights

## Design of a modular hybrid combination rear light

- 1) Housing
- 2) LED module tail stop light
- 3) Bulb module direction indicator
- 4) Bulb module reversing light
- 5) Bulb module rear fog light
- 6) LED module direction indicator
- 7) LED module reversing light
- 8) LED module rear fog light
- 9) Carrier frame, black
- 10) Lens

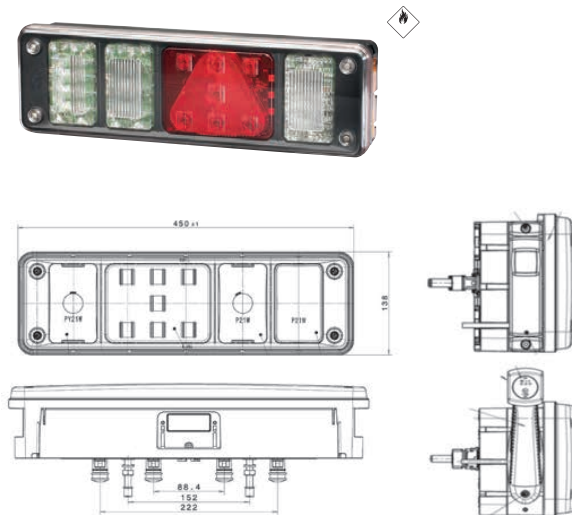

### Note:

The functions stop light, tail light, side marker light and clearance light contain passive electronics with dropping resistors. According to the current state, this does not generate an error message in the vehicle's electrical system.



= ADR / GGVS tested

\* Please see the note on pages 10 - 13 regarding LED direction indicator lights and LED failure check. Refer to pages 60 - 63 for the type approval numbers.



## LED hybrid trailer light

Modular multi-function combination rear light 24 V for horizontal mounting, clear lens, 7-pin EasyConn connector and 4 x 2-pin connector for connecting various functions, with pulse for direction indicator failure check. Tail stop light with 7 red LEDs, direction indicator with 7 amber LEDs, reversing light with 6 white LEDs, rear fog light with 7 red LEDs.

Tail light: 24 V/10 W, current consumption = approx. 0.42 A  
 Stop light: 24 V/13 W, current consumption = approx. 0.54 A  
 Direction indicator: 24 V/3 W, current consumption = approx. 0.13 A  
 Reversing light: 24 V/2.5 W, current consumption = approx. 0.10 A  
 Rear fog light: 24 V/2.5 W, current consumption = approx. 0.10 A  
 Clearance light: 24 V/1.2 W, current consumption = approx. 0.05 A  
 Side marker reflex reflector light:  
 24 V/1 W, current consumption = approx. 0.04 A

IP protection classes: Light IP 5K4K, LED modules IP 6K9K

### Full-LED tail triangular reflex reflector stop light, direction indicator, rear fog light, reversing light

left	2VP 340 960-011*
right	2VP 340 960-021*

### Full-LED tail triangular reflex reflector stop light, direction indicator, rear fog light, reversing light, clearance light in the rubber arm

left	2VP 340 960-111*
right	2VP 340 960-121*



# Combination rear lights

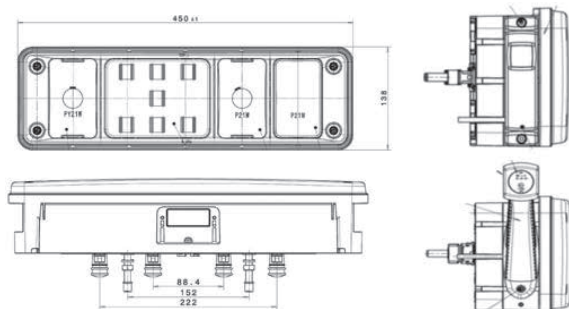

## Modular hybrid trailer lights

24 V, tail stop light generally in LED, all other functions are possible with bulb or LED technology.

## Program overview

Part number	Variations			Functions					
	Hybrid	Left	Right	Tail light triangular reflex reflector stop light	Direction indicator light	Rear fog light	Reversing light	Clearance light	Side marker light
2VP 340 961-011	X	X	-	LED	Bulb	Bulb	Bulb	-	-
2VP 340 961-021	X	-	X	LED	Bulb	Bulb	Bulb	-	-
2VP 340 961-031	X	X	-	LED	Bulb	LED	Bulb	-	-
2VP 340 961-041	X	-	X	LED	Bulb	LED	Bulb	-	-
2VP 340 961-111	X	X	-	LED	Bulb	Bulb	Bulb	LED	-
2VP 340 961-121	X	-	X	LED	Bulb	Bulb	Bulb	LED	-
2VP 340 961-131	X	X	-	LED	Bulb	LED	Bulb	LED	-
2VP 340 961-141	X	-	X	LED	Bulb	LED	Bulb	LED	-
2VP 340 961-211	X	X	-	LED	Bulb	Bulb	Bulb	-	LED
2VP 340 961-221	X	-	X	LED	Bulb	Bulb	Bulb	-	LED

# Combination rear lights

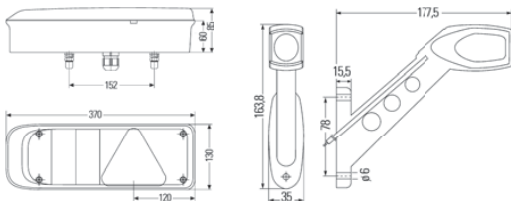
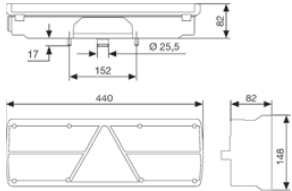
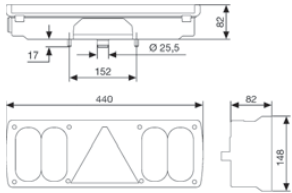

= ADR / GGVs tested

\* Please see the note on pages 10 - 13 regarding LED direction indicator lights and LED failure check. Refer to pages 60 - 63 for the type approval numbers.



## EasyConn I multi-function combination rear light

for horizontal mounting, tail triangular reflex reflector stop, direction indicator, rear fog light, reversing, side marker light with vibration dampening and built-in 24 V bulbs, with 500 mm cable and 7-pin EasyConn male connector housing, for rear adapter 8KA 340 819-, with double bulb in the tail light. Protection class IP 5K9K.

with vertical pattern, right	<b>2VP 340 450-441</b>
with vertical pattern, left	<b>2VP 340 450-451</b>
with horizontal pattern, right	<b>2VP 340 450-501</b>
with horizontal pattern, left	<b>2VP 340 450-511</b>

Tail triangular reflex reflector stop, direction indicator, rear fog light, reversing, side marker reflex reflector light for horizontal mounting on trailers

Lens with vertical optical fields, left with cable gland for 6-wire cable	<b>2VP 340 450-031</b>
Lens with vertical optical fields, right with cable gland for 6-wire cable	<b>2VP 340 450-021</b>
Lens with horizontal optical fields, left with built-in 24 V bulbs, 1.48 m cable and 6-pin female connector housing	<b>2VP 340 450-151</b>
Lens with horizontal optical fields, right with built-in 24 V bulbs, 1.48 m cable and 6-pin female connector housing	<b>2VP 340 450-141</b>



## EasyConn I multi-function combination rear light

for horizontal mounting. Tail triangular reflex reflector stop, direction indicator, rear fog, reversing light with 4 vibration dampers, with built-in 24 V bulbs, 7-pin EasyConn central connector. 2 x tail light with 2 red LEDs each. Protection class IP54.

24 V/1 W, current consumption for LED tail light = approx. 0.04 A

right (without rubber arm)	<b>2VP 340 932-001*</b>
left (without rubber arm)	<b>2VP 340 932-011*</b>

With clearance and side marker light in the rubber arm. With 2 white LEDs for the position light, 1 red LED for the clearance light and 2 amber LEDs for the side marker light. With built-in 24 V bulbs, 7-pin EasyConn central connector. 24 V / 1.5 W, current consumption = approx. 0.05 A

right	<b>2VP 340 934-101*</b>
left	<b>2VP 340 934-111*</b>

# Combination rear lights

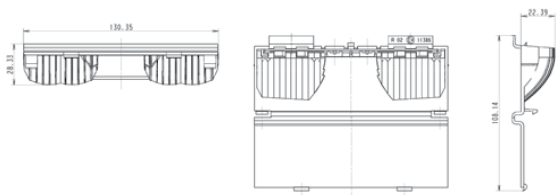

## Retrofit set "LED module for tail light function"

For converting the tail light function from bulbs to LED technology. For EasyConn combination rear lights with bulbs (2VP 340 830-..., 2VP 340 831-..., 2VP 340 930-... and 2VP 340 931-...)

Set, 24 V

**9XX 340 173-801\***

The set consists of 2 reflectors, one for the right and one for the left light, with one PCB each, including 4 red LEDs and adapter cable to connect to the bulb holder. The PCB is seawater-resistant. Module can be simply snapped into the reflector. The two lugs serve for a flat placement of the module. The type approval number is clearly visible and has been stamped into the right tab. At the same time, the lugs cover the type approval number of the bulb version. 24 V / 1 W, current consumption = approx. 0.04 A

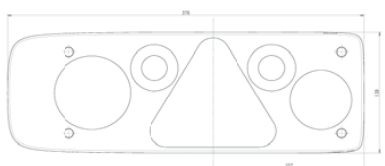
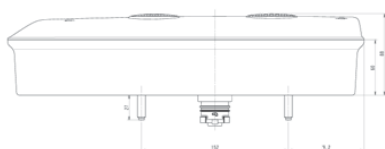

## EasyConn I multi-function combination rear light

for horizontal mounting. Tail triangular reflex reflector stop, direction indicator, rear fog, reversing light with 4 vibration dampers, with built-in 24 V bulbs, 7-pin EasyConn central connector. Tail light function behind the triangular reflex reflector with 10 red LEDs. 24 V/2 W, current consumption = approx. 0.08 A

right (without rubber arm) **2VP 340 942-001\***

left (without rubber arm) **2VP 340 942-011\***

with rubber arm in bulb technology, clear lens for position light, red for clearance light, amber for side marker light. With built-in 24 V bulbs, 7-pin EasyConn central connector.

right **2VP 340 942-101\***

left **2VP 340 942-111\***

with LED rubber arm, with built-in 24 V bulbs and 7-pin EasyConn central connector. 24 V/1.5 W, current consumption = approx. 0.05 A  
 2 white LEDs for position light  
 1 red LED for clearance light  
 2 amber LEDs for side marker light

right **2VP 340 940-101\***

left **2VP 340 940-111\***

with LED rubber arm and black finisher, with 370 mm cable and 7-pin EasyConn central connector.

right **2VP 340 944-141\***

left **2VP 340 944-131\***

# Combination rear lights

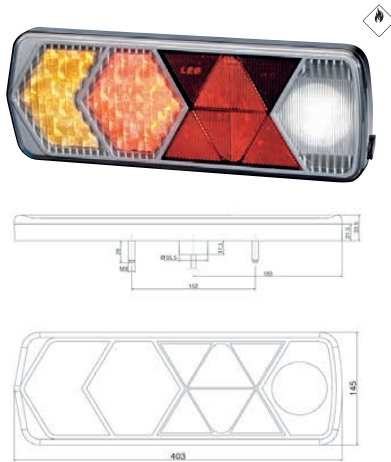

## Full LED multi-function combination rear light

Tail triangular rear reflector stop, direction indicator, reversing light for horizontal mounting, with 500 mm cable and 7-pin EasyConn male connector housing, tightly glued lens, clear on outside, reflector red on inside, ventilation via membrane, with pulse for indicator failure check, protection class IP 6K9K.

Tail light: 15 red LEDs,  
24 V/0.7 W, current consumption = approx. 0.03 A  
Stop light: 15 red LEDs,  
24 V/5 W, current consumption = approx. 0.21 A  
Direction indicator: 15 amber LEDs,  
24 V/3 W, current consumption = approx. 0.125 A  
Reversing light: 1 white LED,  
24 V/5.5 W, current consumption = approx. 0.23 A

Left light with additional outlet from 7-pin EasyConn male connector housing to a 500 mm long cable with 2-pin EasyConn female connector housing for attaching a rear fog light.

left	<b>2VP 340 950-011*</b>
right only with 7-pin connection	<b>2VP 340 950-021*</b>
with cable and 6.3 mm flat receptacles	
left, with 1550 mm cable	<b>2VP 340 950-031*</b>
right, with 2500 mm cable	<b>2VP 340 950-041*</b>

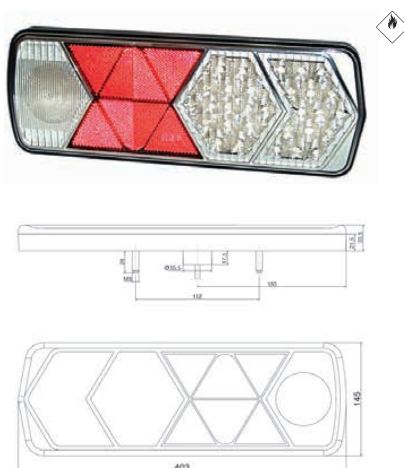

## Full LED multi-function combination rear light

### Version for traction vehicles

Tail light reflex reflector stop light, direction indicator and reversing light, 1500 mm cable with 6.3 mm flat receptacles, with pulse for direction indicator failure check, protection class IP 6K9K.

Tail light: 15 red LEDs,  
24 V/0.7 W, current consumption = approx. 0.03 A  
Stop light: 15 red LEDs,  
24 V/5 W, current consumption = approx. 0.21 A  
Direction indicator: 15 amber LEDs,  
24 V/3 W, current consumption = approx. 0.125 A  
Reversing light: 1 white LED,  
24 V/5.5 W, current consumption = approx. 0.23 A

**2VP 340 950-051\***

= ADR / GGVS tested

\* Please see the note on pages 10 - 13 regarding LED direction indicator lights and LED failure check.  
Refer to pages 60 - 63 for the type approval numbers.

# Multi-function lights

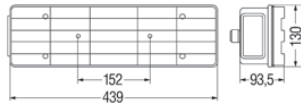

## Multi-function combination rear light

Tail, stop, direction indicator, rear fog, reversing light for horizontal mounting on trailers left / right, with built-in 24 V bulbs

with 1400 mm cable and 6-pin connector **2SK 340 101-001**

without cable and connector **2SK 340 101-021**

Tail, stop, direction indicator, rear fog, reversing, side marker reflex reflector light for horizontal mounting on trailers left / right, with built-in 24 V bulbs.

with 1400 mm cable and 6-pin connector **2SK 340 101-011**

without cable and connector **2SK 340 101-031**

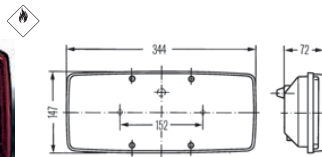
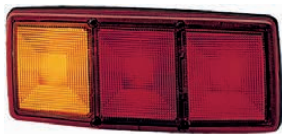

## Multi-function combination rear light

Tail, stop, direction indicator light for horizontal or vertical mounting or installation

left **2SD 003 167-011**

right **2SD 003 167-021**

with license plate light

left **2SE 003 167-031**

right **2SE 003 167-041**



## Multi-function combination rear light

Tail reflex reflector stop, direction indicator, license plate, rear fog, clearance, side marker reflex reflector light

with built-in 24 V bulbs and lateral central connector

left **2VD 007 500-411**

right, without license plate and rear fog light **2VP 007 500-421**

with built-in 24 V bulbs / cable and 8-pin AMP connector

left, with side marker reflex reflector **2VD 007 500-091**

left, with side marker reflex reflector **2VD 007 500-201**

left, with side marker reflex reflector light **2VD 007 500-111**

right, with side marker reflex reflector light **2VD 007 500-221**

# Multi-function lights

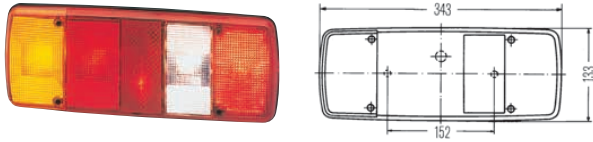

## Multi-function combination rear light

Tail, stop, direction indicator, rear fog light without reflex reflector for horizontal mounting or installation on trailers and traction vehicles

left, with license plate light	<b>2SL 003 567-311</b>
left, without license plate light	<b>2SK 003 567-331</b>
right, without license plate light	<b>2SK 003 567-321</b>
for double bulbs in the tail light	
left	<b>2SK 003 567-651</b>
right	<b>2VP 003 567-661</b>

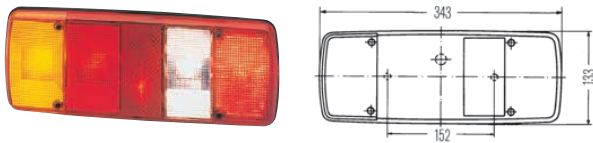

## Multi-function combination rear light

Tail, reflex reflector, stop, direction indicator, rear fog reversing light for horizontal mounting or installation on traction vehicles, permitted for trailers

left	<b>2VP 003 567-111</b>
right	<b>2VP 003 567-121</b>

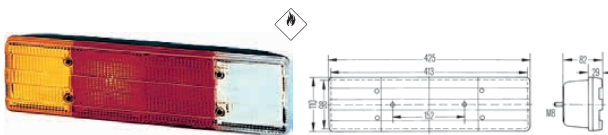

## Multi-function combination rear light

Tail, reflex reflector, stop, direction indicator, license plate, rear fog light for horizontal mounting

left	<b>2VB 004 887-011</b>
left, with reversing light, without license plate light	<b>2VA 004 887-031</b>
right, without license plate and rear fog light	<b>2VP 004 887-021</b>

 = ADR / GGVS tested

\* Please see the note on pages 10 - 13 regarding LED direction indicator lights and LED failure check. Refer to pages 60 - 63 for the type approval numbers.

# Multi-function lights

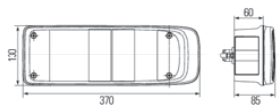
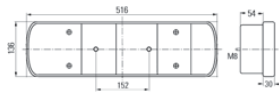

a)

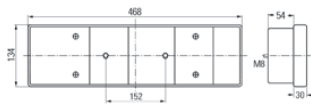

b)



## Multi-function combination rear light

Tail, reflex reflector, stop, direction indicator, rear fog, reversing, clearance, side marker reflex reflector light

for VOLVO and SCANIA vehicles

left, with license plate light **2VD 008 205-011**

right, without license plate light **2VD 008 205-021**

with 7-pin AMP connector and 160 mm hole spacing

left, with license plate light **2VD 008 205-051**

right, with license plate light **2VD 008 205-041**

left / right, without license plate light **2VP 008 205-031**



## Multi-function combination rear light

Tail, reflex reflector, stop, direction indicator, rear fog, reversing, side marker reflex reflector light

with 8-pin Schlemmer connector and 24 V bulbs / double bulbs in the tail light

left **2VP 340 888-011**

right **2VP 340 888-001**



## Multi-function combination rear light

Tail, reflex reflector, stop, direction indicator, license plate, rear fog, reversing, clearance, side marker reflex reflector light for Mercedes Benz vehicles

a) with 8-pin Schlemmer connector

right, without license plate light **2VP 008 204-081**

left **2VD 008 204-091**

b) cable inlet through the centre of the housing opening

right, without license plate and rear fog light **2VP 008 204-101**

left **2VD 008 204-111**

# Multi-function lights

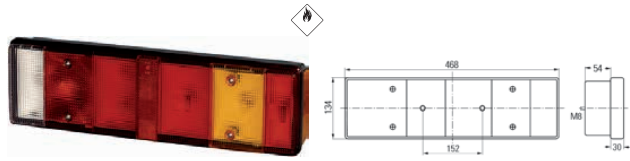

## Multi-function combination rear light

Tail reflex reflector stop, direction indicator, license plate, rear fog, clearance, side marker reflex reflector light

with 8-pin AMP connector for MAN and SCANIA vehicles

left / right, without license plate light and side marker reflex reflector	<b>2VP 008 204-041</b>
--	------------------------

left / right, without side marker reflex reflector	<b>2VD 008 204-051</b>
--	------------------------

left / right, without license plate light	<b>2VP 008 204-061</b>
---	------------------------

left, with license plate light	<b>2VD 008 204-071</b>
--------------------------------	------------------------

without central connector for VW LT platform truck

left / right, without license plate and rear fog light	<b>2VP 008 204-121</b>
--	------------------------

left, with license plate light	<b>2VD 008 204-131</b>
--------------------------------	------------------------

with 8-pin connector for DAF vehicles

right	<b>2VP 008 204-161</b>
-------	------------------------

left, with license plate light	<b>2VD 008 204-171</b>
--------------------------------	------------------------

Universal design with PG screw connection

right, without license plate light	<b>2VP 008 204-201</b>
------------------------------------	------------------------

left	<b>2VD 008 204-211</b>
------	------------------------

with 7-pin lateral AMP connector for RVI vehicles

right, without license plate light	<b>2VP 008 204-221</b>
------------------------------------	------------------------

left	<b>2VD 008 204-231</b>
------	------------------------

with 7-pin lateral AMP connector for MAN vehicles

right, without license plate light	<b>2VP 008 204-241</b>
------------------------------------	------------------------

left	<b>2VD 008 204-251</b>
------	------------------------

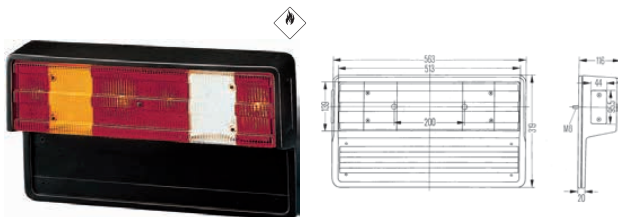

## Multi-function combination rear light

Tail, reflex reflector, stop, direction indicator, license plate, rear fog, reversing, clearance and side marker reflex reflector

left	<b>2VD 005 300-551</b>
------	------------------------

right	<b>2VD 005 300-581</b>
-------	------------------------

= ADR / GGVS tested

\* Please see the note on pages 10 - 13 regarding LED direction indicator lights and LED failure check. Refer to pages 60 - 63 for the type approval numbers.



# Multi-function lights

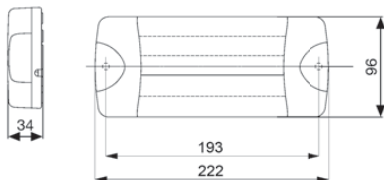
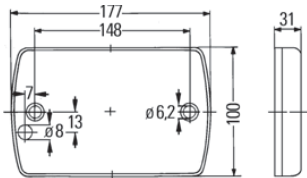

## Tail, stop, direction indicator and reversing light

for horizontal and vertical mounting, clear lens, 2500 mm cable with stripped ends. Protection class IP 6K6 and IP 6K7. Multi-voltage 3–33 V.

Tail stop light, 24 red LEDs

horizontal **2SB 980 606-201\***

vertical **2SB 980 606-701\***

Direction indicator, 24 amber LEDs  
with pulse for direction indicator failure check

horizontal **2BA 980 607-201\***

vertical **2BA 980 607-701\***

Reversing light, 24 white LEDs

horizontal **2ZR 980 605-201\***

vertical **2ZR 980 605-701\***



## Combination rear light DuraLED Combi

Tail, stop, direction indicator light for horizontal and vertical mounting, clear lens, with 40 LEDs and potted 2500 mm potted cable with stripped ends and pulse for direction indicator failure check,

tail light with 8 red LEDs

direction indicator with 16 amber LEDs

stop light with 24 red LEDs

Of the 24 red stop light LEDs, 8 LEDs are used with reduced light output for the tail light.

Multi-voltage 8–28 V

**2SD 959 050-401\***

# Multi-function lights

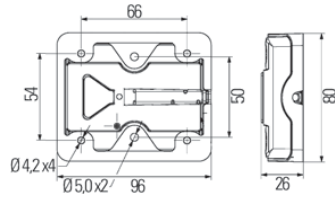

## Tail, stop, direction indicator light with reflex reflector

for 12 and 24 V, for horizontal or vertical mounting, with 8 LEDs, clear lens, 500 mm cable with stripped ends and firmly glued-on red reflector. Detachable black retaining frame with 4 holes  $\varnothing 4.2$  mm and 2 holes  $\varnothing 5.0$  mm for fastening screws. Without a pulse for direction indicator failure check, protection class IP 6K9K, IP 6K7.

24 V/5 W, current consumption = approx. 0.21 A

**2VA 980 720-001**

Can be mounted and can be turned by  $180^\circ$ , with license plate lighting for plates 370 mm x 120 mm and 520 mm x 120 mm.

For illuminating a license plate from right and left, the lights 2VB 980 720-401 and -501 must be used.

24 V/5 W, current consumption = approx. 0.21 A

**2VB 980 720-401**

24 V/5 W, current consumption = approx. 0.21 A

**2VB 980 720-501**

### Possible uses

12 / 24 V, LED flasher

**4JZ 177 846-007**

Female connector housing

**8JA 003 526-001**

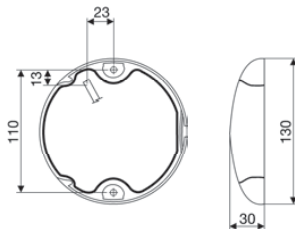

## EuroLED combination rear light

for horizontal mounting, cast in one piece with the base plate, electrical connection through cable 2500 mm long, multi-voltage 9 – 33 V.

### Tail stop light

Red lens, with 1 red LED

**2SB 959 821-601\***

### Rear fog light

Clear lens, with 1 red LED

**2NE 959 821-201\***

### Reversing light

White lens, with 1 white LED

**2ZR 959 820-601\***

### Direction indicator

with pulse for direction indicator failure check amber lens, with 1 amber LED

**2BA 959 822-601\***

 = ADR / GGVs tested

\* Please see the note on pages 10 - 13 regarding LED direction indicator lights and LED failure check. Refer to pages 60 - 63 for the type approval numbers.

# Multi-function lights

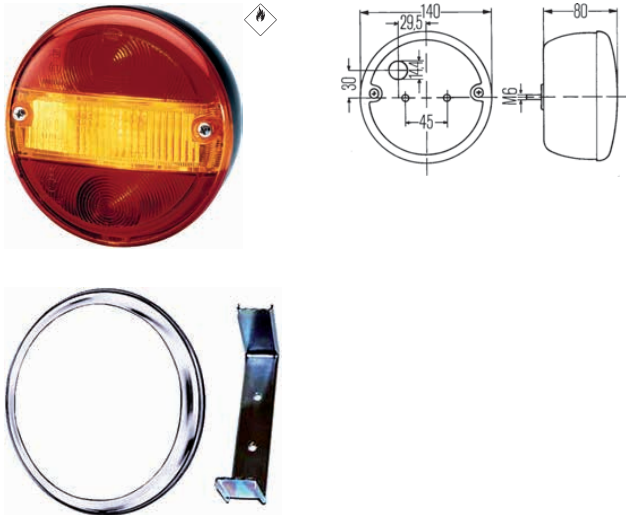

## Direction indicator, stop and tail light

Bulb-based version

with license plate light **2SE 001 685-201**

without license plate light **2SD 001 685-211**

with integrated vibration damper **2SD 001 685-221**

with integrated vibration damper and license plate light **2SD 001 685-231**

Chrome-design ring with attachment bracket for installation **9XD 997 909-801**

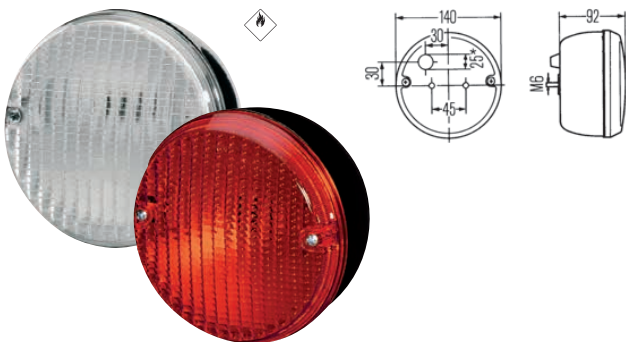

## Rear fog and reversing light

Bulb-based version

Rear fog light, red lens **2NE 001 423-011**

Reversing light, white lens **2ZR 001 423-001**

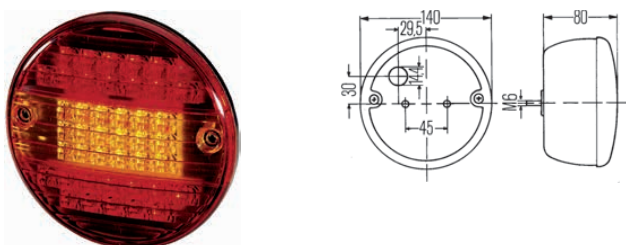

## LED tail stop direction indicator light

for horizontal mounting, with red / amber / red lens and black housing, 42 LEDs and 500 mm cable, with passive thermal management, without pulse for direction indicator failure check.

Tail light 0.5 W, stop light 2 W, direction indicator 3 W  
current consumption at 24 V approx. 0.23 A

Multi-voltage 9 - 32 V **2SD 001 685-347**

### Possible uses

12 / 24 V, LED flasher **4JZ 177 846-007**

Female connector housing **8JA 003 526-001**



# Multi-function lights

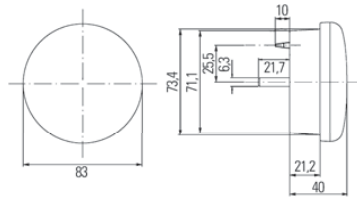

## LED tail stop direction indicator light

for installation, with clear cover lens, 24 V, 16 LEDs and 2500 mm cable, with pulse for direction indicator failure check, protection class IP 6K6, IP 6K7.

24 V / 5 W, current consumption = approx. 0.21 A

**2SD 959 010-401\***

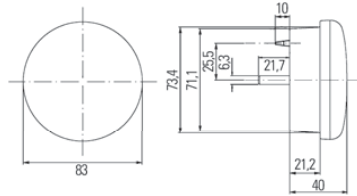

## LED tail stop light

for installation, with red lens, 24 V, 12 LEDs and 2500 mm cable, protection class IP 6K6, IP 6K7.

24 V / 4 W, current consumption = approx. 0.17 A

**2SB 959 010-301\***

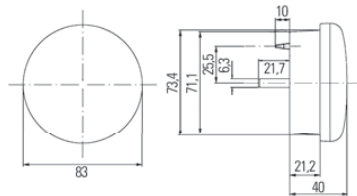

## LED direction indicator

for installation, with amber lens, 24 V, 12 LEDs and 2500 mm cable, with pulse for direction indicator failure check, protection class IP 6K6, IP 6K7.

24 V / 3 W, current consumption = approx. 0.13 A

**2BA 959 011-301\***

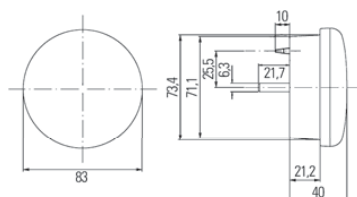

## LED reversing light

for installation, with clear lens, with 24 LEDs and 2500 mm cable, multi-voltage 9 – 33 V, protection class IP 6K6, IP 6K7.

24 V / 4 W, current consumption = approx. 0.17 A

**2ZR 959 010-501\***



= ADR / GGVS tested

\* Please see the note on pages 10 - 13 regarding LED direction indicator lights and LED failure check. Refer to pages 60 - 63 for the type approval numbers.

# Multi-function lights

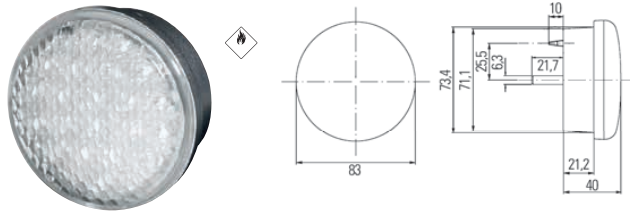

## LED rear fog light

for installation, with clear lens, with 24 LEDs and 2500 mm cable, multi-voltage 9 – 33 V, protection class IP 6K6, IP 6K7.

24 V / 3 W, current consumption = approx. 0.13 A **2NE 959 011-501\***

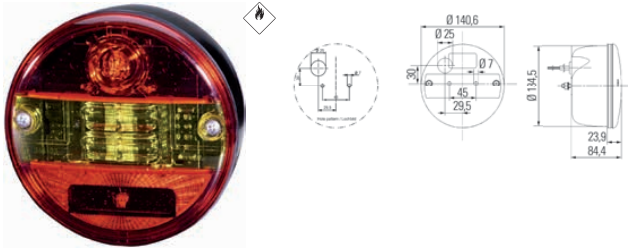

## LED tail stop direction indicator light

for horizontal mounting, with red / amber / red lens and black housing, 2 LEDs for direction indicator, 1 LED for tail light, 1 LED for stop light, with active thermal management, with pulse for direction indicator failure check, protection class: IP 6K9K.

Tail light 3 W / stop light 2 W / direction indicator 4 W  
24 V, current consumption = approx. 0.38 A

Multi-voltage 9 - 32 V **2SD 344 100-101\***

Chrome-design ring with attachment bracket for installation **9XD 997 909-801**



## LED tail stop direction indicator light

for mounting, 24 LEDs, with 500 mm cable group, multi-voltage 9 – 32 V, protection class IP 6K9K.

Tail light 1 W / stop light 2 W / direction indicator 2 W  
24 V, current consumption = approx. 0.2 A

### With pulse for direction indicator failure check and with active thermal management

Clear lens **2SD 344 200-001\***  
Red / clear lens **2SD 344 200-071\***

### Without pulse for direction indicator failure check and with passive thermal management

Red / clear lens **2SD 344 200-311**

### Possible uses

12 / 24 V, LED flasher **4JZ 177 846-007**  
Female connector housing **8JA 003 526-001**



# Multi-function lights

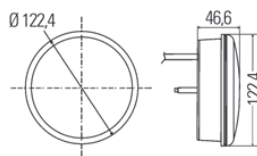
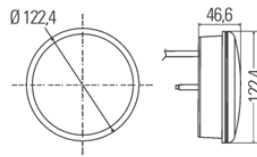
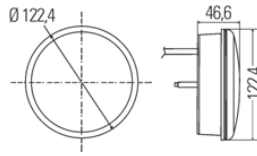

## LED tail stop light

for mounting, 24 LEDs, with 500 mm cable group, multi-voltage 9 – 32 V, protection class IP 6K9K.

### With active thermal management

Tail light 1 W, stop light 3 W / 24 V, current consumption = approx. 0.17 A

Clear lens **2SB 344 200-027\***

Red lens **2SB 344 200-081\***

### With passive thermal management

Tail light 1 W, stop light 5 W / 24 V, current consumption = approx. 0.25 A

24 V, clear lens **2SB 344 200-321**

24 V, red lens **2SB 344 200-331**



## LED direction indicator

for mounting, 24 amber LEDs, with 500 mm cable group, multi-voltage 9 – 32 V, protection class IP 6K9K.

### With pulse for direction indicator failure check and with active thermal management

24 V / 3 W, current consumption = approx. 0.13 A

Clear lens **2BA 344 200-037\***

### Without pulse for direction indicator failure check and with passive thermal management

24 V / 2 W, current consumption = approx. 0.08 A

Clear lens **2BA 344 200-341**

### Possible uses

12 / 24 V, LED flasher **4JZ 177 846-007**

Female connector housing **8JA 003 526-001**



## LED reversing light

for mounting, 24 white LEDs, with 500 mm cable group, clear lens, multi-voltage 9 – 32 V, protection class IP 6K9K.

24 V / 2 W, current consumption = approx. 0.08 A

**2ZR 344 200-051\***

= ADR / GGVS tested

\* Please see the note on pages 10 - 13 regarding LED direction indicator lights and LED failure check. Refer to pages 60 - 63 for the type approval numbers.

# Multi-function lights

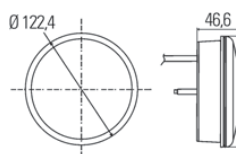

## LED rear fog light

for mounting, 24 white LEDs, with 500 mm cable group, multi-voltage 9 – 32 V, protection class IP 6K9K. 24 V / 2 W, current consumption = approx. 0.08 A

Clear lens	<b>2NE 344 200-061*</b>
Red lens	<b>2NE 344 200-091*</b>

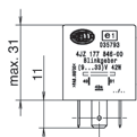
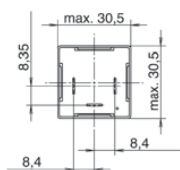

## LED flasher

For LED direction indicators 12 V and 24 V, black plastic housing with blade terminals, voltage 9 – 33 V, max. load 42 W

Universal connection of LED direction indicator lights that do not contain an electronic pulse:

- 2BA 344 200-341
- 2SD 344 200-311
- 2SD 001 685-347
- 2VA 980 720-001
- 2VB 980 720-401/-501

Protection class IP 54 for upright mounting / downward clamping; IP 53 for hanging or sideways mounting

	<b>4JZ 177 846-007</b>
Mounting of flasher unit on female connector housing	<b>8JA 003 526-001</b>

# Clearance lights



## LED clearance light

with integrated side marker light in long rubber arm, for lateral upright mounting on vertical surfaces, clear lens, on side with interior amber cover lens, 2 white LEDs for position light, 1 red LED for clearance light and 2 amber LEDs for side marker light.

24 V / 1.5 W, current consumption = approx. 0.05 A

### With 500 mm cable and quick link coupling

right	2XS 340 418-121*
left	2XS 340 418-131*

### With 500 mm cable and 2-pin EasyConn female connector housing

right	2XS 340 418-021*
left	2XS 340 418-031*

### With 3000 mm cable and flat receptacles

right	2XS 340 418-081*
left	2XS 340 418-091*



## LED clearance light

with integrated side marker light in long rubber arm, for lateral upright installation on horizontal surfaces, clear lens, on side with interior amber cover lens, 2 white LEDs for position light, 1 red LED for clearance light and 2 amber LEDs for side marker light.

24 V / 1.5 W, current consumption = approx. 0.05 A

### With 500 mm cable and quick link coupling

right	2XS 340 448-021*
left	2XS 340 448-031*

### With 500 mm cable and 2-pin EasyConn female connector housing

right	2XS 340 448-001*
left	2XS 340 448-011*

### Accessories

Clamping element for quick link cabling	8KW 998 602-002
Mounting pliers for quick link cabling	8PE 008 932-001

 = ADR / GGVS tested

\* Please see the note on pages 10 - 13 regarding LED direction indicator lights and LED failure check. Refer to pages 60 - 63 for the type approval numbers.



# Clearance lights

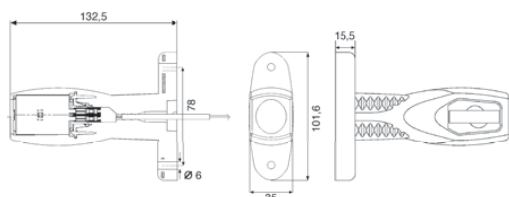

## LED clearance light

with integrated side marker light in short rubber arm, usable on left and right side, for side mounting on vertical surfaces, clear lens, on side with interior amber cover lens, 2 white LEDs for position light, 1 red LED for clearance light and 2 amber LEDs for side marker light.

24 V / 1.5 W, current consumption = approx. 0.05 A

### With 500 mm cable and quick link coupling

right / left	2XS 340 447-001*
--------------	------------------

### With 500 mm cable and 2-pin EasyConn female connector housing

right / left	2XS 340 447-021*
--------------	------------------

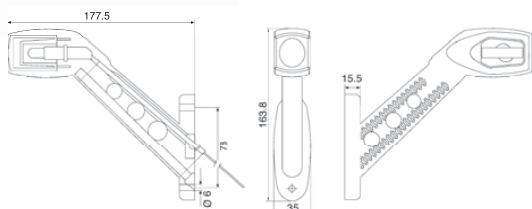

## Clearance light

for lateral upright mounting (vertically), with black rubber arm and rubber frame, integrated side marker light, 4 W bulb, clear lenses for position light / red for clearance light / amber for side marker light, protection class IP 5K4K.

### with 500 mm cable and 2-pin EasyConn female connector housing

right	2XS 340 827-001
-------	-----------------

left	2XS 340 827-011
------	-----------------

### With 300 mm cable and quick link coupling

right	2XS 340 827-121
-------	-----------------

left	2XS 340 827-131
------	-----------------

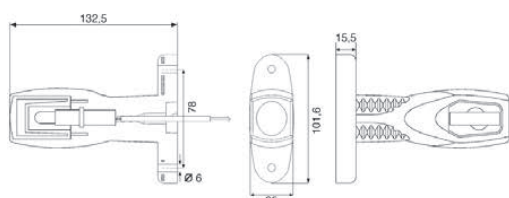

## Clearance light

For lateral mounting, left and right

With 500 mm cable and quick link coupling	2XS 302 240-031
---	-----------------

with 500 mm cable and 2-pin EasyConn female connector housing /	2XS 302 240-051
---	-----------------

# Clearance lights

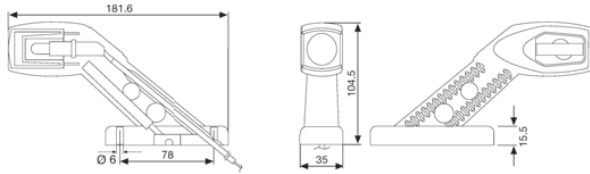

## Clearance light

For lateral, upright mounting on horizontal surfaces, protection class IP 5K9K

with 500 mm cable and EasyConn female connector housing

left	2XS 302 241-071
------	-----------------

right	2XS 302 241-081
-------	-----------------

With 500 mm cable and quick link coupling

left	2XS 302 241-091
------	-----------------

right	2XS 302 241-101
-------	-----------------

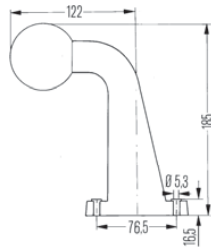
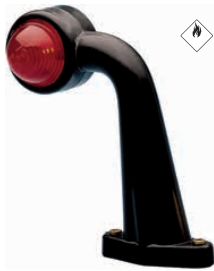

## Clearance light

for upright mounting, milky white lens at front / red at rear, housing with arm made of black rubber.

2XS 950 071-031

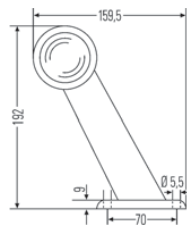

## Clearance light

for upright mounting, milky white lens at front / red at rear, housing with arm made of black rubber.

2XS 955 232-001

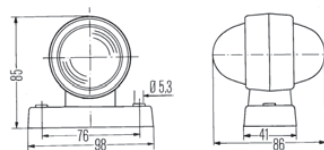

## Clearance light

for mounting, milky white lens at front / red at rear loosely included, housing with arm made of black rubber.

2XS 955 031-001



= ADR / GGVS tested

\* Please see the note on pages 10 - 13 regarding LED direction indicator lights and LED failure check. Refer to pages 60 - 63 for the type approval numbers.

# Clearance lights

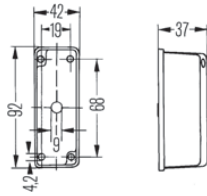

## Clearance light

for lateral mounting, without bulb and with grommet.

clear lens at front, red at rear	2XS 005 020-001
black lens at front, red at rear	2XS 005 020-041

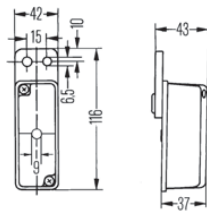

## Clearance light

for lateral mounting (55 x 42 mm), without bulb, with grommet and rubber pendulum.

clear lens at front, red at rear	2XS 005 020-011
black lens at front, red at rear	2XS 005 020-091

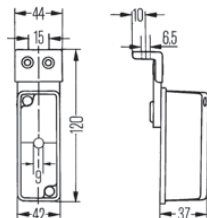

## Clearance light

for lateral mounting, without bulb, with rubber pendulum, with attachment bracket and grommet.

clear lens at front, red at rear	2XS 005 020-021
black lens at front, red at rear	2XS 005 020-111

## Accessories

Clear / red replacement lens	9EL 132 215-011
Black / red replacement lens	9EL 132 215-001

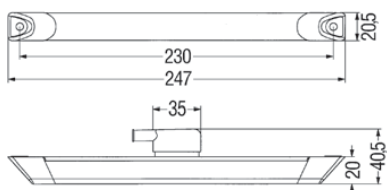

## LED tail light/clearance light

for horizontal or vertical mounting on trailers and articulated lorries with boxes, with 2 red LEDs, clear lens, with grommet, base plate and grey plastic caps, with prism rod as a light exit element. 2 holes, Ø 5.4 mm, for fastening screws.

24 V / 1.4 W, current consumption = approx. 0.06 A

24 V	2XS 008 078-001*
------	------------------

# License plate lights

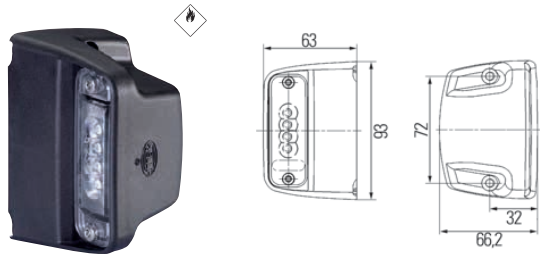

## LED license plate light

for mounting on the right or left next to the license plate (520 x 120 mm), only 1 light needed for illumination. Clear lens, with 4 LEDs, black plastic housing, 2 fastening screws M5 x 35.

24 V / 1 W, current consumption = approx. 0.04 A

with blade terminal 6.3 x 0.8	<b>2KA 010 278-021*</b>
with 500 mm cable and 2-pin EasyConn connector	<b>2KA 010 278-051*</b>
with 500 mm cable and quick link coupling	<b>2KA 010 278-041*</b>
with 2000 mm cable and blade terminal 6.3 x 0.8	<b>2KA 010 278-031*</b>

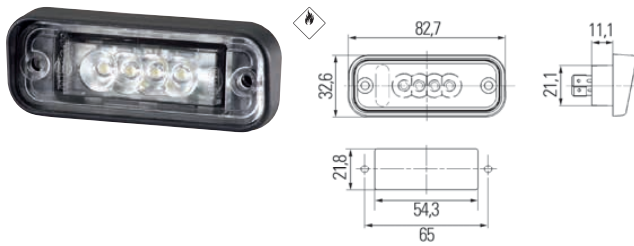

## LED license plate light

for installation above the license plate (520 x 120 mm), 2 lights required to illuminate the license plate, protection class: IP 6K9K.

24 V / 1 W, current consumption = approx. 0.04 A

with blade terminal 6.3 x 0.8	<b>2KA 010 278-011*</b>
Light contacts firmly bonded, with 1000 mm cable with open cable ends	<b>2KA 010 278-607*</b>

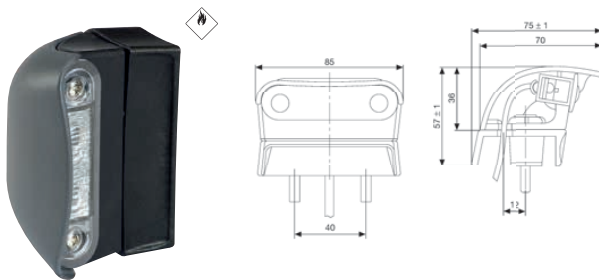

## LED license plate light

for mounting left and right next to the license plate (520 x 120 mm), with 2 white LEDs, clear lens, housing and base made of black plastic, bulb holder with vibration dampening, with 2 caulked screws, multi-voltage 10 – 33 V.

24 V / 0.5 W, current consumption = approx. 0.02 A

with 500 mm cable and 2-pin EasyConn female connector housing	<b>2KA 959 640-661*</b>
with 2500 mm cable	<b>2KA 959 640-607*</b>

= ADR / GGVS tested

\* Please see the note on pages 10 - 13 regarding LED direction indicator lights and LED failure check. Refer to pages 60 - 63 for the type approval numbers.

# License plate lights

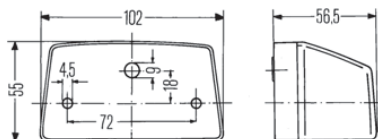
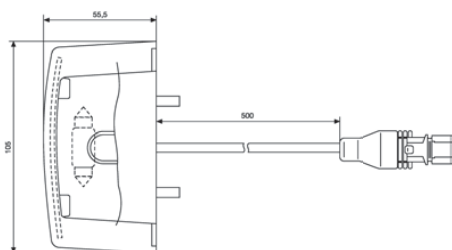

## License plate light

for mounting on the right or left of the license plate 340 x 240 mm and 520 x 120 mm, clear lens, black plastic housing, with built-in festoon bulb light and integrated M5 fastening screws, protection class IP 5K9K

with 500 mm cable and 2-pin EasyConn female connector housing **2KA 340 828-001**

with 500 mm cable and quick link cabling (fits flat cable 8KA 340 822-...)  
**2KA 340 828-041**

with 3000 mm cable, open cable ends **2KA 340 828-011**

## Accessories

Clamping element for quick link cabling **8KW 998 602-002**

Mounting pliers for quick link cabling **8PE 008 932-001**



## LED license plate light

for mounting on the right and left of the license plate (520 x 120 mm), 2 lights, clear lens, base and housing made of black plastic, 72 mm distance between screws

with blade terminal **2KA 003 389-061**

# Reflex reflectors

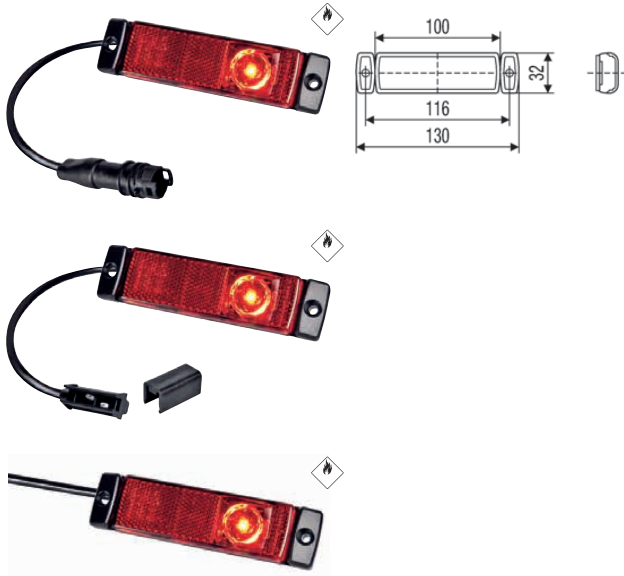

## LED tail light with reflex reflector

can also be used as a clearance light with reflex reflector, for horizontal or vertical mounting, with 1 red LED, red light, black housing and 2 holes for fastening screws B4.2. Possible to fasten using a bracket (must be ordered separately).

24 V / 1.2 W, current consumption = approx. 0.05 A

For horizontal mounting, the LED field must point to the outer vehicle edge. For vertical mounting, the LED field may point upwards or downwards.

with 500 mm cable	<b>2TM 008 645-951*</b>
with 5000 mm cable	<b>2TM 008 645-941*</b>
with 5000 mm cable and 2-pin EasyConn male connector housing	<b>2TM 008 645-351*</b>
with 300 mm cable, with quick link coupling including clamping element for contacting a 2-wire flat cable	<b>2TM 008 645-651*</b>
with 5000 mm cable, with quick link coupling including clamping element for contacting a 2-wire flat cable	<b>2TM 008 645-661*</b>



## LED tail light with reflex reflector

for horizontal mounting, with 2 red LEDs, red lens, black base plate, without bracket, with 5000 mm cable.

24 V / 1.0 W, current consumption = approx. 0.04 A

24 V	<b>2TM 963 639-317</b>
------	------------------------

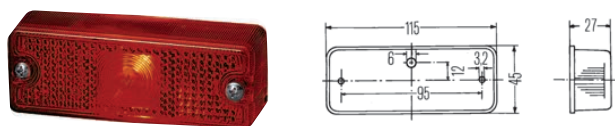

## Tail light with reflex reflector

for horizontal or vertical mounting, red lens, black housing.

24 V	<b>2TM 003 748-011</b>
------	------------------------

= ADR / GGVS tested

\* Please see the note on pages 10 - 13 regarding LED direction indicator lights and LED failure check. Refer to pages 60 - 63 for the type approval numbers.

# Reflex reflectors

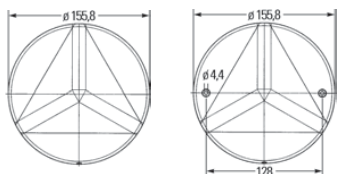
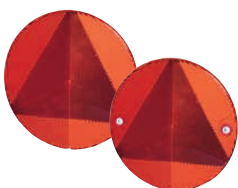

## Reflex reflectors

Triangular reflex reflector with round exterior shape, type-tested, red

self-adhering

**8RA 343 220-007**

with 2 holes for fastening screws

**8RA 343 220-017**

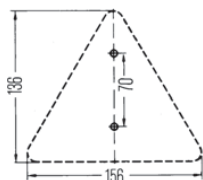

## Triangular reflex reflector

2 holes,  $\varnothing$  6 mm, for fastening screws, type-tested, red

**8RA 002 020-001**

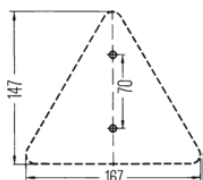

## Triangular reflex reflector

with rubber protective frame, 2 fastening screws M6 x 15, distance 70 mm, red

**8RA 002 010-011**

# Reversing spotlights

## Flying blind or in illuminated enjoyment?

A new law applying to the lighting equipment of newly registered trucks and trailers has been in force in Germany since July 2006 (legal regulations also apply to the converting or retrofitting):

### Three variants are possible:

- 1. Two additional reversing headlamps on the rear.
- 2. In each case one additional reversing headlamp per side.
- 3. Two additional reversing headlamps on the rear plus an additional reversing headlamp on the side.

### A total of four reversing headlamps are permitted:

Two reversing headlamps on the rear and, in each case, one reversing headlamp on the side. This is the formula for an optimum illumination when reversing.

- The rear mounting of type-tested reversing headlamps is permitted.
- The lateral mounting on each side of the car of in each case one additional reversing headlamp is permitted.
- It is not permitted to rear mount front fog lights as was previously allowed.
- The use of work lights as reversing headlamps remains illegal.

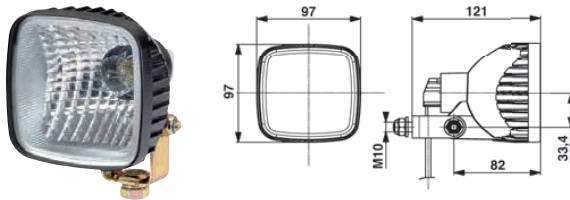

ECO 21 reversing headlight

Permitted special lighting as reversing headlight 00AR  
For vehicle rear and vehicle side, brilliant light through a clear lens, optimum price/performance ratio, lower current consumption due to 21 Watt bulb, low temperature on the lens, IP 6K9K.

24 V, with 500 mm connection cable

2ZR 996 179-701

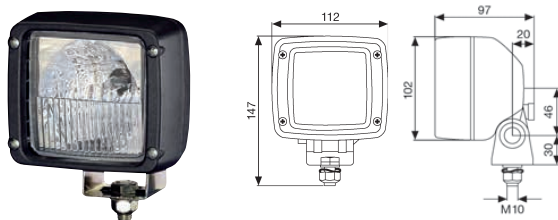

Ultra Beam H3 reversing headlight

Permitted special lighting as reversing headlight 00AR  
For vehicle rear and vehicle side, IP 6K9K.

24 V, with AMP connector

2ZR 996 506-501



= ADR / GGVS tested

\* Please see the note on pages 10 - 13 regarding LED direction indicator lights and LED failure check.  
Refer to pages 60 - 63 for the type approval numbers.



# Accessories



## Direction indicator control unit

for 24 V trailer, with a 15-pin. EasyConn male connector housing on one as well as a 15-pin EasyConn male connector housing on the other side, no independent power supply required. Protection class IP6K9K, with EMC approval

5DS 009 552-001



## Hazard warning light Model 3003 ACCU

when the engine is running, the rechargeable battery is charged through contacts in the charging bracket. Automatic voltage switchover to match the vehicle's electrical system 12 / 24 V, operating time in flashing mode 40 hours or 7 hours as work light, charging bracket and lead-gel rechargeable battery included in the scope of supply

type-tested

2XW 007 146-011



## Hazard warning light Model 3003

with fastening bracket  
(for battery operation through 5 mono cells, not included in the scope of supply)

type-tested

2XW 007 146-001



## Cabling

The modular, flexible cabling and lighting system for 24 V trailers from HELLA guarantees process reliability and a great variance of application cases.

The new high-tech thermo-plastic elastomer (TPE) extrusion-coating enormously increases the temperature range and impact-resistance.

Advantages: Assembly-friendly, long-life and high-quality cabling and lighting systems from lighting specialist, HELLA.

# Cabling



## Front adapter for articulated lorries

Front adapter cable 2 x 7-wire with 15-pin EasyConn male connector housing, 7-N socket DIN-ISO 1185 (cable 3 x 2.5 mm<sup>2</sup> / 4 x 1.5 mm<sup>2</sup>)  
7-S socket DIN-ISO 3731 (cable 7 x 1.5 mm<sup>2</sup>)  
Fits the main supply cables of series 8KA 340 815-..., 8KA 340 816-... and 8KA 340 817-...

1.700 mm long	<b>8KA 340 818-001</b>
600 mm long	<b>8KA 340 818-011</b>



## Front adapter for trailers

GGVS-tested front adapter cable 2 x 7-wire with 15-pin EasyConn male connector housing, 7-N connector DIN-ISO 1185 (cable 3 x 2.5 mm<sup>2</sup> / 4 x 1.5 mm<sup>2</sup>), 7-S socket DIN-ISO 3731 (cable 7 x 1.5 mm<sup>2</sup>)  
Fits the main supply cables of series 8KA 340 815-..., 8KA 340 816-... and 8KA 340 817-...

3500 mm long	<b>8KA 340 841-001</b>
6000 mm long	<b>8KA 340 841-021</b>



## Front adapter for articulated lorries

Front adapter cable 15-wire (12 x 1.0 mm<sup>2</sup> / 3 x 2.5 mm<sup>2</sup>) with 15-pin EasyConn male connector housing, 15-pin socket DIN-ISO 12098, fits the main supply cables of series 8KA 340 815-..., 8KA 340 816-... and 8KA 340 817-...

600 mm long	<b>8KA 340 842-001</b>
1.700 mm long	<b>8KA 340 842-011</b>



## Front adapter for trailers

Front adapter cable 15-wire (12 x 1.0 mm<sup>2</sup> / 3 x 2.5 mm<sup>2</sup>) with 15-pin EasyConn male connector housing, 15-pin connector DIN-ISO 12098, fits the main supply cables of series 8KA 340 815-..., 8KA 340 816-... and 8KA 340 817-...

3500 mm long	<b>8KA 340 843-001</b>
4500 mm long	<b>8KA 340 843-011</b>
6000 mm long	<b>8KA 340 843-021</b>



# Cabling



### EasyConn flat cable

Supply cable (2 x 1.5 mm<sup>2</sup>) to connect side marker lights with reflex reflector and position lights per quick link cabling or indentation clamping technology, with 2-pin EasyConn female connector housing and heat-shrunk end cap

6000 mm long	<b>8KA 340 822-071</b>
10000 mm long	<b>8KA 340 822-081</b>
13500 mm long	<b>8KA 340 822-051</b>

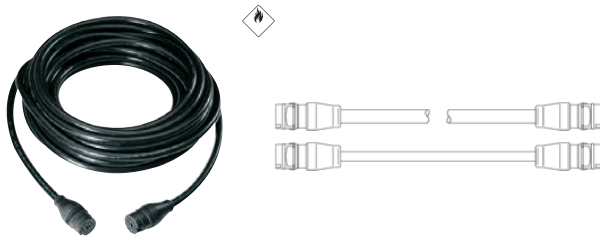

### Main supply cable 15-wire

12 x 1.0 mm<sup>2</sup> / 3 x 2.5 mm<sup>2</sup>, with two 15-pin EasyConn female connector housings, pre-fitted and extrusion-coated, without additional outlets.

15500 mm long	<b>8KA 340 815-001</b>
10000 mm long	<b>8KA 340 815-011</b>
12000 mm long	<b>8KA 340 815-021</b>

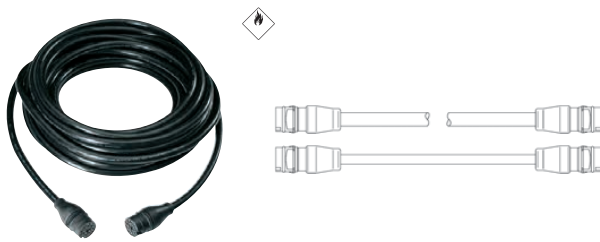

### Main supply cable 10-wire

8 x 1.0 mm<sup>2</sup> / 2 x 2.5 mm<sup>2</sup>, with two 15-pin EasyConn female connector housings, pre-fitted and extrusion-coated, without additional outlets

9000 mm long	<b>8KA 340 816-001</b>
12000 mm long	<b>8KA 340 816-011</b>



### Main supply cable 15-wire with outputs

(12 x 1.0 mm<sup>2</sup> / 3 x 2.5 mm<sup>2</sup>), with two 15-pin EasyConn female connector housings, pre-fitted and extrusion-coated. 1 - 4 outlets (in each case 300 mm long) with 2-pin EasyConn female connector housing (for additional functions like, for example, reversing light or stop light) are possible. Upon request, the connector assignment of the 2-pin EasyConn female connector housing can be specified individually. The coloured marking is provided according to function.

15000 mm long, with two 300 mm long outputs with 2-pin EasyConn female connector housing (1 x brown for tail light, right 1 x black for tail light, left)	<b>8KA 340 817-011</b>
---	------------------------



# Cabling

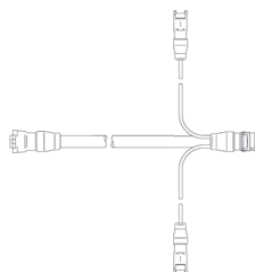
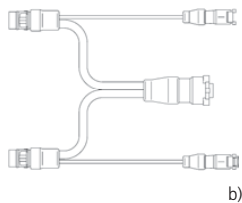
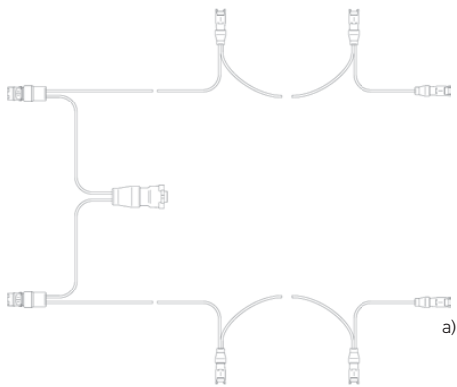

## Rear adapter

Rear adapter cable with 15-pin EasyConn male connector housing. Fits the main supply cables of series 8KA 340 815-..., 8KA 340 816-... and 8KA 340 817-...

with two 7-wired cables ( $6 \times 1.0 \text{ mm}^2 / 1 \times 1.5 \text{ mm}^2$ ), in each case 1300 mm long, starting on two 7-pin EasyConn female connector housing (for combination rear lights).

As well as with each side three 2-pin EasyConn male connector housings (e.g. for license plate, rubber arm lights and SMLR chains), linked by means of two cables ( $2 \times 0.5 \text{ mm}^2$ ) on each side, with a cable length of 500 mm between the individual male connector housings.

Figure a)

**8KA 340 819-001**

with two 7-wired cables ( $6 \times 1.0 \text{ mm}^2 / 1 \times 1.5 \text{ mm}^2$ ), in each case 3,000 mm long, starting on two 7-pin EasyConn female connector housing (for combination rear lights).

As well as with each side a 2-pin EasyConn male connector housing (e.g. for SMLR chain), one of which is sealed tight with a cap, linked by a 3000 mm long flat cable ( $2 \times 1.5 \text{ mm}^2$ ) on each side (e.g. for clearance light with quick link cabling).

Figure b)

**8KA 340 819-041**



## Intermediate adapter

Adapter cable 15-wire ( $12 \times 1.0 \text{ mm}^2 / 3 \times 2.5 \text{ mm}^2$ ), 500 mm long. With 15-pin EasyConn male connector housing and 15-pin EasyConn female connector housing. 1 - 4 outlets (in each case 300 mm long) with 2-pin EasyConn female connector housing (for additional functions like, for example, reversing light or stop light) are possible. Upon request, the connector assignment of the 2-pin EasyConn female connector housing can be specified individually. The coloured marking is provided according to function.

with two outlets (in each case 300 mm long) on the side of the 15-pin EasyConn female connector housing, with in each case one 2-pin EasyConn male connector housing (1 x red for stop light, 1 x lilac for reversing light)

**8KA 340 846-001**

# Cabling

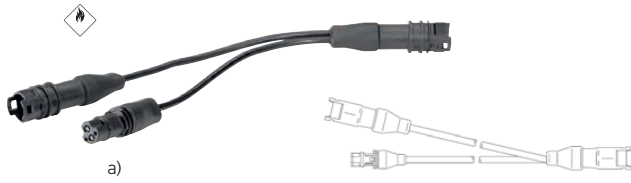

a)

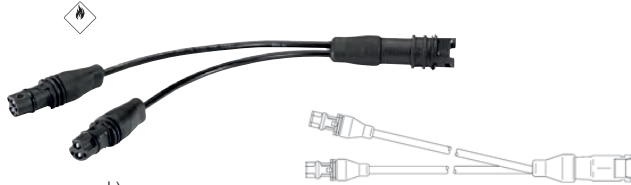

b)

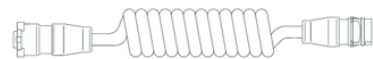

## Intermediate adapter

Y adapter cable 2-wire (2 x 0.5 mm<sup>2</sup>)

with 2-pin EasyConn male connector housing and two 150 mm long outlets with one 2-pin EasyConn male connector housing as well as one 2-pin EasyConn female connector housing

Figure a)

**8KA 340 859-001**

with 2-pin EasyConn male connector housing and two 150 mm long outlets with in each case one 2-pin EasyConn female connector housing

Figure b)

**8KA 340 859-011**

## Harness

Harness FRONT AS, with connector 24 V (ISO 12098) for trailers with flat beds or boxes. With 14-wire (11 x 1.5 mm<sup>2</sup>, 3 x 2.5 mm<sup>2</sup>), with 15-pin connector. Fits main supply cable 8KA 340 010-... as well as 15-pin connector (DIN-ISO 12098).

3500 mm long

**8KA 340 031-001**

## Wendelflex cable

8-wire adapter cable (7 x 1 mm<sup>2</sup>/ 1 x 2.5 mm<sup>2</sup>), with 15-pin EasyConn male connector housing and 15-pin EasyConn female connector housing, pre-fitted and extrusion-coated. Can be used as an adapter cable between the main supply cable and the rear or front adapter cable.

3000 mm long (working length) coiled cable

**8KA 340 845-031**

## Adapter

Adapter cable with cable and 2-pin EasyConn female connector housing for connecting to the EasyConn system.

1000 mm

**8KA 340 852-051**

6000 mm

**8KA 340 852-027**

# Cabling

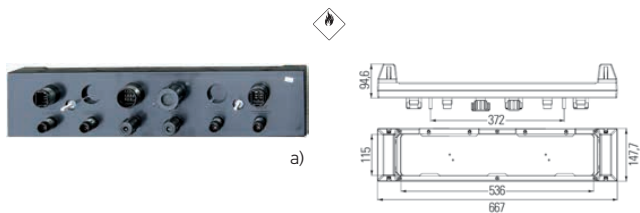

a)

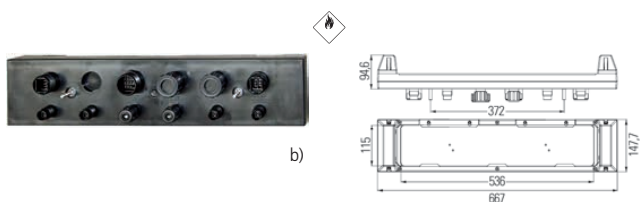

b)

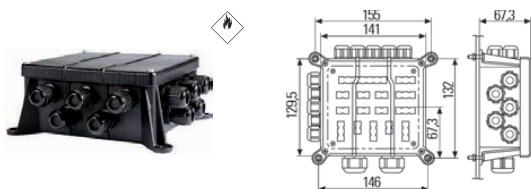
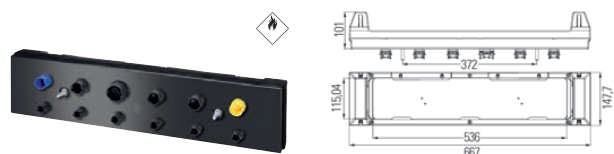

## Combination distributor

For connecting all technical lighting functions (24 V) to the rear.  
With license plate light and mounting part for license plate 520 x 120 mm.  
With black cover at the front and back and a 6-pin socket for additional lighting functions, terminal 9 - 15 interior light, work light, all-round beacons.

Figure a) **8JE 340 060-001**

Figure b) **8JE 340 060-011**



## Combination distributor

EasyConn combination distributor with integrated license plate lighting for holding the license plate. With a 15-pin, five 7-pin and six 2-pin EasyConn connections for all technical lighting functions.  
With separately protected lighting circuits.

**8JE 340 060-251**



## Distributor box

with cable glands as an alternative to 8JE 340 060-001.

Universal electrically contacting and can be mounted using flat receptacles 6.3 x 0.8 mm:

- 1 blade terminal strip with 14 terminals,
- 6 blade terminal strips with 6 terminals,
- 8 blade terminal strips with 4 terminals.

Provided with 12 cable glands:  
10 x clamping area 3.5 - 10 mm,  
2 x clamping area 9 - 18 mm.

**8JE 340 151-001**

# Cabling

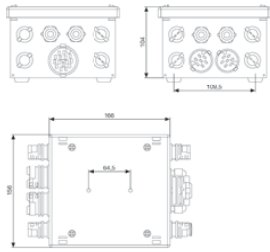
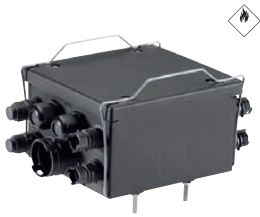

## Distributor box

with a 15-pin EasyConn connection (for the main supply), 2 x 7-pin EasyConn connections (for combination rear lights), 8 x 2-pin EasyConn connections (for, for example, SMLR, license plate, clearance lights or special functions) as well as 4 x M20 cable glands, completely wired via pin block.

8JE 340 867-011

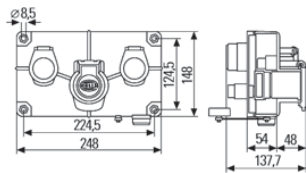

## Combination distributor

For connecting the technical lighting functions of the trailer.

With 3 sockets on the front side:  
(24-N socket, 7-pin, as per DIN-ISO 1185 and 24-S socket, 7-pin, as per DIN-ISO 3731 as well as 15-pin socket as per DIN-ISO 12098) as input module for trailers and articulated lorries with or without flat beds.

On the back with 1 x 15-pin bush to fit main supply cable 8KA 340 010-241 or adapter 8KA 340 010-251 with 2 x 2-pin bush for optimum connection of the side marker / clearance lights, protected by 2 flat fuses (2 A).

Front mounting

8JE 340 165-001

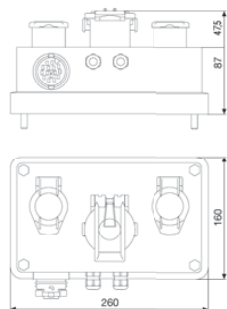

## Front distributor for articulated lorries

for direct connection to the EasyConn system, with three combined sockets (1 x socket DIN-ISO 12098, 1 x 7-N socket DIN-ISO 1185 and 1 x 7-S socket DIN-ISO 3731), a 15-pin EasyConn connection (for the main supply) as well as two sealed M16 cable glands.

Distributor box for front connection

8JE 340 898-001





# Cabling

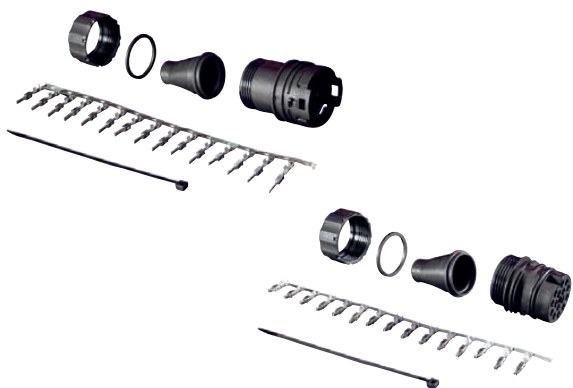

## Service sets

for customer-specific cabling requirements (pre-fitted) for connecting to the EasyConn system. Including cable ties and respective number (2, 7 or 15) of contacts (blade terminals or flat receptacles).

To fit the following HELLA cables:

2-pin cable FLRY Y (2 x 1 mm <sup>2</sup> )	<b>8KL 340 009-001</b>
2-pin harness (1 mm <sup>2</sup> )	<b>8KL 340 052-001</b>
2-pin harness (0.5 mm <sup>2</sup> )	<b>8KL 340 055-021</b>
7-pin cable FLRY Y (6 x 1.0 mm <sup>2</sup> / 1 x 1.5 mm <sup>2</sup> )	<b>8KL 340 412-001</b>
7-pin harness (2.5 mm <sup>2</sup> )	<b>8KL 340 054-001</b>
10-pin harness (2.5 mm <sup>2</sup> )	<b>8KL 340 093-011</b>
15-pin cable FLRY Y (12 x 1.0 mm <sup>2</sup> / 3 x 2.5 mm <sup>2</sup> )	<b>8KL 340 059-001</b>

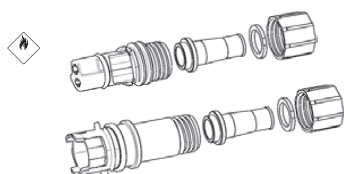

2-pin

with 2-pin EasyConn female connector housing  
(mating connector and 2-pin EasyConn male connector housing)

Diameter: approx. 19.5 mm	<b>9XX 340 879-001</b>
Diameter: approx. 24.5 mm	<b>9XX 340 882-001</b>

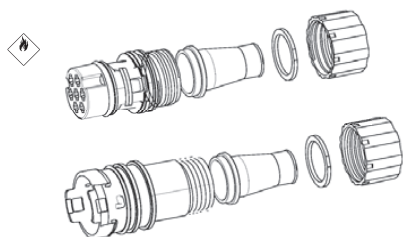

7-pin

with 7-pin EasyConn female connector housing  
(mating connector and 7-pin EasyConn male connector housing)

Diameter: approx. 28.0 mm	<b>9XX 340 880-001</b>
Diameter: approx. 33.0 mm	<b>9XX 340 883-001</b>

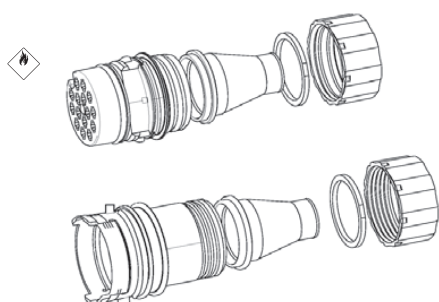

15-pin

with 15-pin EasyConn female connector housing  
(mating connector and 15-pin EasyConn male connector housing)

Diameter: approx. 39.0 mm	<b>9XX 340 881-001</b>
Diameter: approx. 44.0 mm	<b>9XX 340 884-001</b>

# Cabling



### Connection set

For 2-wire flat cable or round cable. Fits combination distributor 8JE 340 060-... and for 2-wire flat cable 8KL 340 050-...

2-pin

**9XX 340 220-001**



### Connection set

For 2-wire round cable. 1 connection set for LED side marker light with reflex reflector 2PS 340 001-... and 1 connection set for combination distributor 8JE 340 060-...

2-pin (PU 2)

**9XX 340 220-011**



### Connection set

for 2-wire round cable. For connection of 10 LED side marker lights 2PS 340 001-... Fits combination distributor 8JE 340 060-...

2-pin

**9XX 340 220-801**



### Connection set

Fits combination distributor 8JE 340 060-..., as spare part for combination rear lights with 6-wire cable and connector as well as for the distributor socket 8JE 340 061-...

for 6-wire cable

**9XX 340 222-001**



### Connection set

15-pin connection set for main power cable. Fits combination distributor 8JE 340 060-... and front distributor 8JE 340 165-001 and as spare part for the following cables: 8KA 340 010-..., 8KA 340 020-..., 8KA 340 021-..., 8KA 340 030-... and 8KA 340 031-...

15-pin

**9XX 340 223-001**



# Cabling

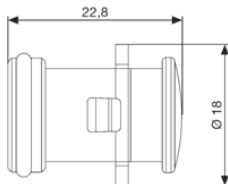
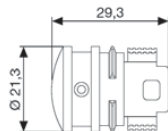
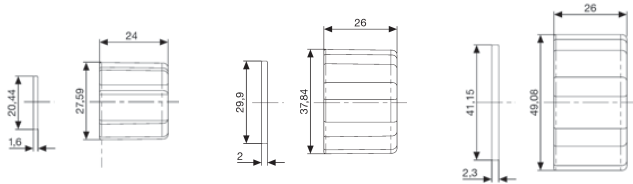
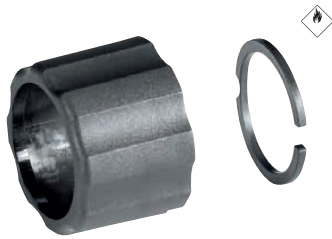

## Fuse sets

for additional protection of EasyConn connector with high tensile loads with sliding ring and union nut.

for 2-pin EasyConn male connector housing (PU 20)	<b>9XX 340 876-007</b>
for 7-pin EasyConn male connector housing (PU 10)	<b>9XX 340 877-007</b>
for 15-pin EasyConn male connector housing (PU 5)	<b>9XX 340 878-007</b>



## Locking cap

for female connector housing for a tight seal of unrequired EasyConn female connector housings

for 2-pin EasyConn female connector housing (PU 20)	<b>9HV 340 812-007</b>
---	------------------------



## Locking sets

for male connector housing for tight seal of unrequired EasyConn male connector housings with o-ring



for 2-pin EasyConn male connector housing (PU 20)	<b>9XX 340 870-007</b>
for 7-pin EasyConn male connector housing (PU 10)	<b>9XX 340 871-007</b>
for 15-pin EasyConn male connector housing (PU 5)	<b>9XX 340 872-007</b>



## Spare parts

Quick link clamping element	<b>8KW 998 602-002</b>
Heat-shrunk end cap up to max. 11 mm cable diameter (7-pin)	<b>9GS 340 051-001</b>

# Overview

	No.	Part number	PU	Page		No.	Part number	PU	Page
<b>Front lighting</b>					<b>Rear lighting</b>				
1	1395, 1398	2PG 008 645-321*	1	16	1	–	9EL 132 215-001	2	43
1	1395, 1398	2PG 008 645-331*	1	16	1	–	9EL 132 215-011	2	43
1	1395, 1398	2PG 008 645-341*	1	16	1	71	2SK 340 101-001	1	29
1	1395, 1398	2PG 008 645-631*	1	16	1	71	2SK 340 101-011	1	29
1	1395, 1398	2PG 008 645-641*	1	16	1	71	2SK 340 101-021	1	29
1	1395, 1398	2PG 008 645-961*	1	16	1	71	2SK 340 101-031	1	29
1	1395, 1398	2PG 008 645-971*	1	16	1	264, 53250	2SD 003 167-011	1	29
1	2300	2PF 009 514-001*	1	17	1	264, 53250	2SD 003 167-021	1	29
1	2300	2PF 009 514-011*	1	17	1	597	2KA 340 828-001	1	45
1	31410, 21682	2PG 003 748-151	4	17	1	597	2KA 340 828-011	1	45
4	7575	2PF 959 570-202*	2	16	1	597	2KA 340 828-041	1	45
4	7575	2PF 959 570-212*	2	16	1	1395, 1398	2TM 008 645-351*	1	46
4	7597	2PF 959 590-202*	2	16	1	1395, 1398	2TM 008 645-651*	1	46
4	7597	2PF 959 590-212*	2	16	1	1395, 1398	2TM 008 645-661*	1	46
4	11371	2PF 340 825-001*	1	17	1	1395, 1398	2TM 008 645-941*	1	46
4	11371	2PF 340 825-057	50	17	1	1395, 1398	2TM 008 645-951*	1	46
17	0002	2PG 963 639-401*	1	17	1	2376	2VP 340 950-011*	1	28
17	0002	2PG 963 639-411*	1	17	1	2376	2VP 340 950-021*	1	28
<b>Side lighting</b>					1	2376	2VP 340 950-031*	1	28
1	439	2PS 340 000-011	1	21	1	2376	2VP 340 950-041*	1	28
1	291, 3141	2PS 003 748-121	4	21	1	2376	2VP 340 950-051*	1	28
1	1395, 1396	2PS 008 645-001*	1	20	1	2609	2KA 010 278-011*	1	44
1	1395, 1396	2PS 008 645-301*	1	20	1	2609	2KA 010 278-021*	1	44
1	1395, 1396	2PS 008 645-311*	1	20	1	2609	2KA 010 278-031*	1	44
1	1395, 1396	2PS 008 645-361*	1	20	1	2609	2KA 010 278-041*	1	44
1	1395, 1396	2PS 008 645-611*	1	20	1	2609	2KA 010 278-051*	1	44
1	1395, 1396	2PS 008 645-621*	1	20	1	2609	2KA 010 278-607*	30	44
1	1395, 1396	2PS 008 645-991*	1	20	1	3389	2KA 003 389-061	2	45
1	31410, 291	2PS 003 748-161	4	21	1	8496	2NE 001 423-011	1	35
17	9605	2PS 963 639-011*	1	21	1	8704	2ZR 001 423-001	1	35
17	9605	2PS 963 639-071*	1	21	1	13484	8RA 002 010-011	20	47
17	9704	2PS 963 959-001	4	21	1	31407	2XS 005 020-001	10	43
17	9704	2PS 963 959-011	4	21	1	31407	2XS 005 020-011	10	43
24	5853	2PS 343 690-031	1	20	1	31407	2XS 005 020-021	10	43
24	5853	2PS 343 690-411	1	20	1	31407	2XS 005 020-041	10	43
24	5853	2PS 343 690-621	1	20	1	31407	2XS 005 020-091	2	43
					1	31407	2XS 005 020-111	2	43

\* Please see the notes on pages 10 and 13 regarding LED direction indicators and LED direction indicator failure check.

# Overview

(E)	No.	Part number	PU	Page	(E)	No.	Part number	PU	Page
1	31410	2TM 003 748-011	4	46	4	3178, 4060, 9808, 9810	2VD 008 204-071	1	32
1	31432, 63217	2VD 007 500-091	1	29	4	3178, 9808, 9810	2VP 008 204-121	1	32
1	31432, 63217	2VD 007 500-111	1	29	4	3178, 9808, 9810	2VD 008 204-131	1	32
1	31432, 63217	2VD 007 500-201	1	29	4	<b>3178, 9808, 9810</b>	<b>2VP 008 204-201</b>	<b>1</b>	32
1	31432, 63217	2VD 007 500-221	1	29	4	3178, 9808, 9810	2VD 008 204-211	1	32
1	31432, 63217	2VD 007 500-411	1	29	4	3178, 4060, 9808, 9810	2VP 008 204-221	1	32
1	31432, 63217	2VP 007 500-421	1	29	4	3178, 4060, 9808, 9810	2VD 008 204-231	1	32
1	31432, 63217	2VD 005 300-551	1	32	4	3178, 4060, 9808, 9810	2VP 008 204-241	1	32
1	31432, 63217	2VD 005 300-581	1	32	4	3178, 4060, 9808, 9810	2VD 008 204-251	1	32
1	53384	2VB 004 887-011	1	30	4	3178, 4060, 9811	2VD 008 205-011	1	31
1	53384	2VA 004 887-021	1	30	4	3178, 4060, 9811	2VD 008 205-021	1	31
1	53384	2VP 004 887-031	1	30	4	3178, 4060, 9811	2VP 008 205-031	1	31
1/4	1072/280	2VP 340 450-021	1	26	4	3178, 4060, 9811	2VD 008 205-041	1	31
1/4	1072/280	2VP 340 450-031	1	26	4	3179, 4060, 9809, 9810	2VP 008 204-081	1	31
1/4	1072/280	2VP 340 450-141	1	26	4	3179, 4060, 9809, 9810	2VD 008 204-091	1	31
1/4	1072/280	2VP 340 450-151	1	26	4	3179, 9809, 9810	2VP 008 204-101	1	31
1/4	1072/280	2VP 340 450-441	1	26	4	3179, 9809, 9810	2VD 008 204-111	1	31
1/4	1072/280	2VP 340 450-451	1	26	4	3191	8RA 343 220-007	30	47
1/4	1072/280	2VD 340 450-491	1	26	4	3191	8RA 343 220-017	30	47
1/4	1072/280	2VP 340 450-501	1	26	4	4068	2KA 959 640-607*	8	44
1/4	1072/280	2VP 340 450-511	1	26					
4	377, 397, 421, 3134, 3880, 23215	2VP 003 567-111	1	30					
4	377, 397, 421, 3134, 3880, 23215	2VP 003 567-121	1	30					
4	377, 396, 397, 3880, 23215	2VP 003 567-311	1	30					
4	377, 396, 397, 3880, 23215	2VP 003 567-321	1	30					
4	377, 396, 397, 3880, 23215	2SK 003 567-651	1	30					
4	377, 396, 397, 3880, 23215	2VP 003 567-661	1	30					
4	3178, 4060, 9808, 9810	2VP 008 204-041	1	32					
4	3178, 4060, 9808, 9810	2VD 008 204-051	1	32					
4	3178, 4060, 9808, 9810	2VP 008 204-061	1	32					

# Overview

(E)	No.	Part number	PU	Page	(E)	No.	Part number	PU	Page
4	4068	2KA 959 640-661*	1	44	4	11391	2NE 959 011-501*	1	37
4	10176	2SD 959 050-401*	1	33	4	11777, 11392	2VP 340 944-131*	1	27
4	10208	2NE 959 821-201*	1	34	4	11779	2VP 340 942-001*	1	27
4	10208	2BA 959 822-601*	1	34	4	11779	2VP 340 942-011*	1	27
4	10208	2SB 959 821-601*	1	34	4	11779	2VP 340 942-101*	1	27
4	10208	2ZR 959 820-601*	1	34	4	11779	2VP 340 942-111*	1	27
4	10211	2XS 302 240-031	1	41	4	11779, 11392	2VP 340 940-101*	1	27
4	10211	2XS 302 240-051	1	41	4	11779, 11392	2VP 340 940-111*	1	27
4	10211	2XS 302 241-071	1	42	4	11779, 11392	2VP 340 944-141*	1	27
4	10211	2XS 302 241-081	1	42	4	12371, 12658	2SD 344 200-311	1	37
4	10211	2XS 302 241-091	1	42	4	12371, 12658, 14198	2SD 344 200-001*	1	37
4	10211	2XS 302 241-101	1	42					
4	10211	2XS 340 827-001	1	41	4	12371, 12658, 14198	2ZR 344 200-051*	1	38
4	10211	2XS 340 827-011	1	41					
4	10211	2XS 340 827-121	1	41	4	12371, 12658, 14198	2NE 344 200-061*	1	39
4	10211	2XS 340 827-131	1	41					
4	10211, 11392	2XS 340 418-021*	1	40	4	12371, 12658, 14198	2SD 344 200-071*	1	37
4	10211, 11392	2XS 340 418-031*	1	40					
4	10211, 11392	2XS 340 418-081*	1	40	4	12371, 12658, 14198	2NE 344 200-091*	1	39
4	10211, 11392	2XS 340 418-091*	1	40					
4	10211, 11392	2XS 340 418-121*	1	40	4	12373	2SB 959 010-301*	1	36
4	10211, 11392	2XS 340 418-131*	1	40	4	12373	2BA 959 011-301*	1	36
4	10211, 11392	2XS 340 447-001*	1	41	4	12658	2SB 344 200-027*	24	38
4	10211, 11392	2XS 340 447-021*	1	41	4	12658	2BA 344 200-037*	24	38
4	10211, 11392	2XS 340 448-001*	1	40	4	12658	2SB 344 200-081*	1	38
4	10211, 11392	2XS 340 448-011*	1	40	4	12658	2SB 344 200-321	1	38
4	10211, 11392	2XS 340 448-021*	1	40	4	12658	2SB 344 200-331	1	38
4	10211, 11392	2XS 340 448-031*	1	40	4	12658	2BA 344 200-341	1	38
4	10218, 10219	2VP 340 888-001	1	31	4	13136	2SD 344 100-101*	1	37
4	10218, 10219	2VP 340 888-011	1	31	4	23006	2ZR 996 506-501	1	48
4	10218, 11386	2VP 340 932-001	1	26	4	23262	2ZR 996 179-701	1	48
4	10218, 11386	2VP 340 932-011	1	26	9	1538	2SD 959 010-401*	1	36
4	10218, 11386, 11392	2VP 340 934-101	1	26	12	7146	2SD 001 685-211	1	35
					12	7146	2SD 001 685-231	1	35
4	10218, 11386, 11392	2VP 340 934-111	1	26	13	0515	2XS 008 078-001*	1	43
					13	9401	2XS 950 071-031	2	42
4	11386	9XX 340 173-801	1	27	13	9401	2XS 955 031-001	2	42
4	11391	2ZR 959 010-501*	1	36	13	9401	2XS 955 232-001	2	42

\* Please see the notes on pages 10 and 13 regarding LED direction indicators and LED direction indicator failure check.



# Overview

<b>E</b>	<b>No.</b>	<b>Part number</b>	<b>PU</b>	<b>Page</b>
17	346	8RA 002 020-001	25	47
17	0102	2SD 001 685-347	1	35
17	9808	2TM 963 639-317	20	46
24	5850	2ZR 980 605-201*	1	33
24	5850	2ZR 980 605-701*	1	33
24	5850	2SB 980 606-201*	1	33
24	5850	2SB 980 606-701*	1	33
24	5850	2BA 980 607-201*	1	33
24	5850	2BA 980 607-701*	1	33
24	5860	2VA 980 720-001	1	34
24	5860	2VB 980 720-401	1	34
24	5860	2VB 980 720-501	1	34
24	5855, 5856	2VP 340 960-011*	1	24
24	5855, 5856	2VP 340 960-021*	1	24
24	5855, 5856	2VP 340 960-111*	1	24
24	5855, 5856	2VP 340 960-121*	1	24
24	5855, 5856	2VP 340 961-011	1	25
24	5855, 5856	2VP 340 961-021	1	25
24	5855, 5856	2VP 340 961-031	1	25
24	5855, 5856	2VP 340 961-041	1	25
24	5855, 5856	2VP 340 961-111	1	25
24	5855, 5856	2VP 340 961-121	1	25
24	5855, 5856	2VP 340 961-131	1	25
24	5855, 5856	2VP 340 961-141	1	25
24	5855, 5856	2VP 340 961-211	1	25
24	5855, 5856	2VP 340 961-221	1	25
e1	4906	5DS 009 552-001	1	49
K	13950	2XW 007 146-011	1	49
K	13949	2XW 007 146-001	1	49
-	-	9XD 997 909-801	1	35, 37
-	-	8KW 998 602-002	15	45, 59
-	-	8PE 008 932-001	1	40, 45

**HELLA KGaA Hueck & Co.**

Rixbecker Straße 75  
59552 Lippstadt, Germany  
Tel.: +49 2941 38-0  
Fax: +49 2941 38-7133  
Internet: [www.hella.com](http://www.hella.com)

**HELLA Middle East FZE**

Jebel Ali Free Zone  
P.O. Box 17002  
LOB 19, Office 502  
Dubai  
U.A.E. - United Arab Emirates

**HELLA A/S**

Lundsbjerg Industrivej 13  
DK-6200 Aabenraa  
Tel.: 0045 7330 3600  
Fax: 0045 7330 3602  
e-mail: [info@hella.dk](mailto:info@hella.dk)  
[www.hella.dk](http://www.hella.dk)

© HELLA KGaA Hueck & Co., Lippstadt  
922 999 131-954 KB/04.12/1.0  
Printed in Germany