

# Thermostate und Thermoschalter | *Thermostates and Thermoswitches* | *Thermostates et Thermocontacts*



NFZ Katalog | *Catalog Commercial Vehicles* | *Catalogue véhicule utilitaire*



# 4116.87D1

Typen-Nr.  
Type no.  
N° de type

Öffnungstemperatur  
Opening temperature  
Température d'ouverture

Dichtungsvariante  
Gasket type  
Variante de joint

## Bauprinzip 3-Teller Thermostat | Design-Principle 3 Plate Thermostat | Explication du code article

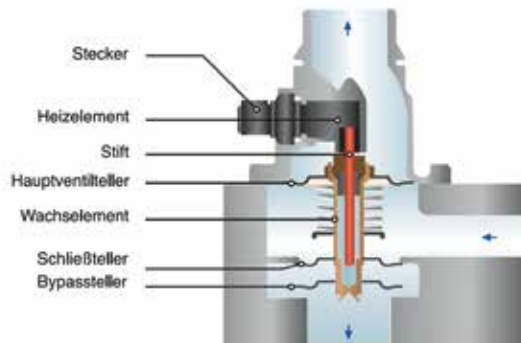

## Funktionsweise Kühlwasserthermostat | Working Principle Cooling Water Thermostat | Principe Fonctionnement Thermostat de refroidissement

**Warmlaufphase:** Der Motor befindet sich nach dem Start in der Warmlaufphase. Der Thermostat ist geschlossen und das Wasser zirkuliert über den inneren Motorkreislauf.

**Warm up period:** The engine enters the warm-up as soon as it is started. The thermostat is closed and the water circulates through the inner engine circuit.

**Phase de mise en action:** Après le démarrage, le moteur se trouve en phase de mise en action. Le thermostat est fermé et l'eau circule via le circuit intérieur du moteur.

**Regelbetrieb:** Die Wassertemperatur erreicht die Öffnungstemperatur des Thermostaten. Eine kleine Menge des Volumenstromes wird über den Kühler geleitet.

**Normal operation:** The water temperature reaches the opening temperature of the thermostat. A small portion of the volumetric flow is fed through the radiator.

**Fonction de régulation:** La température de l'eau atteint la température d'ouverture du thermostat. Une petite quantité du débit volumétrique est dirigée via le radiateur.

**Heißbetrieb:** Der Bypass wird verschlossen. Der ganze Volumenstrom wird über den Kühler geleitet.

**Full temperature operation:** The bypass is sealed. The full volumetric flow is fed through the radiator.

**Fonctionnement à chaud:** Le by-pass est fermé. L'ensemble du débit volumétrique est dirigé via le radiateur.

**Nachheizphase:** Der Thermostat erreicht seinen maximalen Hub bei besonderen Betriebszuständen wie z.B. beim Nachheizen.

**Reheating phase:** Maximum thermostat displacement occurs under special operating conditions such as reheating.

**Phase de post-chauffage:** Le thermostat atteint sa température de réaction maximale lors d'états de fonctionnement particuliers, tels que le post-chauffage.

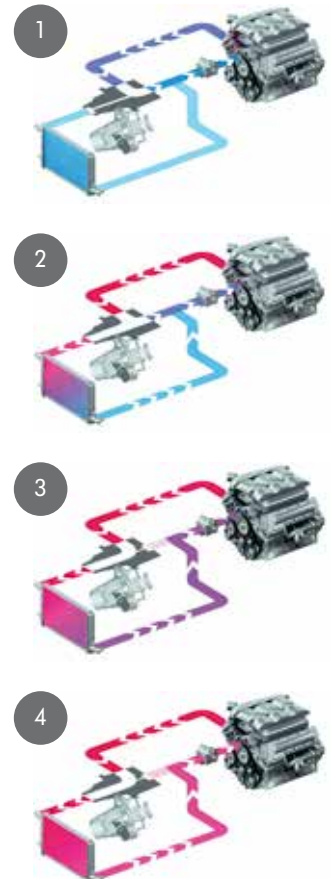

# Inhaltsverzeichnis | Contents | Sommaire

Motor   <i>Engine</i>   <i>Moteur</i>	1 - 13
Vergleichsliste   <i>Cross references</i>   <i>Liste de correspondances</i>	14 - 52
Dichtungszuordnungsliste   <i>Listing of gaskets</i>   <i>Liste de joints</i>	54 - 57
Typenersatzliste   <i>Supersession list</i>   <i>Liste des remplaçants</i>	58
Haupteinbaumaße   <i>Main assembly dimensions</i>   <i>Dimensions principales de montage</i>	60 - 71

Hersteller	Thermostat
CASE / I.H.C.	2
DAF	2
DEUTZ / MWM	2
EVOBUS / SETRA	2
FENDT	2
FIAT	3
FORD	4
HOLDER	4
IVECO	4
LOMBARDINI	5
MAN	6
MERCEDES BENZ	7
MULTICAR	8
PEGASO	8
PEUGEOT	9
RENAULT	9
SAURER	10
SCANIA	10
STEYR	11
VOLKSWAGEN	11
VOLVO	12
ZETOR	13

**BorgWarner Thermal Systems** ist ein führender Lieferant für Wärmemanagement-Systeme.

**BorgWarner Thermal Systems** is a leading supplier of components and systems for thermal management.

**BorgWarner Morse TEC** ist weltweit führend bei der Herstellung von Kettensystemen und -komponenten für Ventilgetriebe, Automatikgetriebe und Vierradantriebe.

**BorgWarner Morse TEC** is the global leader of automotive chain systems and components for engine timing, automatic transmission and four-wheel drive applications.

**BorgWarner TorqTransfer Systems** ist ein weltweit führender Hersteller von Drehmomentverteilungs- und -management-systemen für Fahrzeuge mit Vierradantrieb.

**BorgWarner TorqTransfer Systems** is a leading manufacturer of torque distribution and management systems for four-wheel drive vehicles.

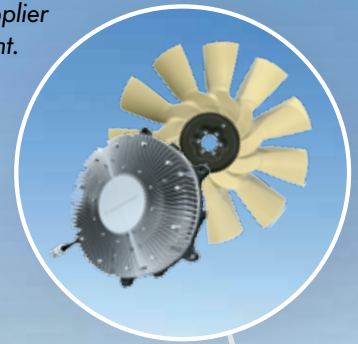

## Innovationen für den Aftermarket. Vom Produktführer im Antriebsbereich.

In einem Punkt sind sich viele Automobilhersteller auf der ganzen Welt einig: Wenn sie die strengsten Abgasnormen erfüllen und Bestmarken beim Verbrauch erzielen wollen, wenn sie enorme Leistungsfähigkeit mit hoher Zuverlässigkeit verbinden wollen, dann führt an BorgWarner kein Weg vorbei. Als Produktführer im Antriebsbereich unterstützen wir die Automobilindustrie dabei, die Fahrzeuggeneration von morgen zu entwickeln. Auch im Aftermarket ist BorgWarner erste Wahl. Und dies nicht nur wegen der schon sprichwörtlichen Qualität unserer Produkte. Sondern auch wegen der Auswahl, Serviceleistungen und Schnelligkeit, die wir unseren Partnern im Ersatzteilgeschäft bieten.

## Unsere Lösungen: Präzise, zuverlässig, wirtschaftlich.

Die BorgWarner Business Unit Emissions Systems ist ein weltweit führender Hersteller und Anbieter von modernsten Abgaskontrollsystemen, Zündungstechnik, Dieselmotorenstarttechnologie, PTC-Innenraum-Zuheizern und Thermostaten für Personenkraftwagen und Nutzfahrzeuge auf der ganzen Welt. Mit der Wahler Produktpalette, die seit April 2014 zu BorgWarner gehört und in die Business Unit Emissions Systems integriert wurde, vergrößert sich das Portfolio um eine Vielzahl innovativer Lösungen für das Abgas- und Temperaturmanagement moderner Motoren. Wahler wird als Produktmarke im Aftermarket beibehalten.



**BorgWarner Turbo Systems** ist ein weltweit führender Hersteller von Aufladesystemen für Pkw und Nfz.

**BorgWarner Turbo Systems** is a leading manufacturer of turbochargers for passenger cars and commercial vehicle markets.

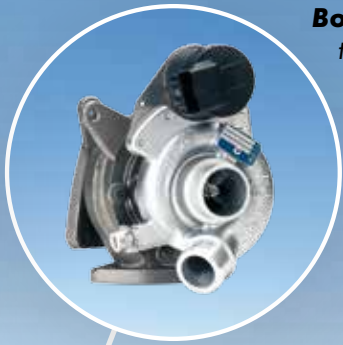

**BorgWarner Emissions Systems** ist weltweit führend bei der Konstruktion und Lieferung von Abgasrückführsystemen (AGR), Zündungstechnik, Diesekaltstarttechnologie, Innenraum-Zuheizern und Thermostaten.



**BorgWarner Emissions Systems** is a leading manufacturer in the design and supply of exhaust gas recirculation (EGR) systems, ignition technology, diesel cold-start technology, cabin heaters and thermostats.

**BorgWarner Transmission Systems** liefert High-Tech-Komponenten und Systeme für praktisch jeden Automatikgetriebe-Hersteller.



**BorgWarner Transmission Systems** supplies "shift quality" components and systems to virtually every automatic transmission manufacturer.

*Innovations for the aftermarket.  
From the product leader in the field of drive technology.*

*Many auto manufacturers all over the world agree on one thing: If they want their engines to meet the toughest emissions standards and break new ground in terms of fuel economy, if they want to combine excellent performance with a high level of reliability, then BorgWarner is the only choice. As product leader in the field of drive technology, we support the automotive industry in developing the vehicle generation of tomorrow. BorgWarner is also the perfect choice in the aftermarket. And not just because of the already legendary quality of our products. But also because of the selection, the range of services and the speed we offer our partners in the spare parts business.*

*Our solutions:  
precise, reliable, economical.*

*BorgWarner's Emissions Systems business unit is a leading global manufacturer and supplier of the latest exhaust gas emissions control systems, ignition technology, diesel cold-start technology, PTC interior heaters and thermostats for passenger vehicles and commercial vehicles all over the world. And with the product range of Wahler, which was acquired by BorgWarner in April 2014 and has been integrated into the Emissions Systems business unit, the product portfolio has been further expanded with a multitude of innovative solutions for the exhaust gas and temperature management of modern engines. Wahler will retain its product brand in the aftermarket segment.*

„Meine Wahl? Das Original.“  
“My Choice? The Original.”



## Thermostate und Thermoschalter

BorgWarner Emissions Systems liefert hochwertige Thermostate und Thermoschalter der Marke Wahler in Erstausrüsterqualität. Sie stehen für einwandfreie Funktion und hohe Zuverlässigkeit. Dank ihres optimalen Wärmemanagements sorgen sie für ein langes Motorleben. Vielfalt nach Maß – BorgWarner hat für alle gängigen Automobilmarken die geeigneten Ersatzteile!

## Thermostates and Thermoswitches

*BorgWarner Emissions Systems is a provider of Wahler brand thermostats and thermoswitches in OE quality. Our parts stand for proper functionality and outstanding reliability. Thanks to the optimum levels of heat management, they also ensure that engines live on, and on... Diversity made to measure – BorgWarner has the right parts for all current makes and models!*



Erst-  
ausrüster  
Qualität

### ■ Vielfalt nach Maß

BorgWarner Emissions Systems hat für 62 Automobilmarken die geeigneten Ersatzteile der Marke Wahler!

### ■ BorgWarner weltweit

BorgWarner ist in allen wichtigen Märkten der Welt mit eigenen Niederlassungen bzw. einem dichten Vertriebsnetz vertreten. Nähere Infos erhalten Sie unter [aftermarket.borgwarner.com](http://aftermarket.borgwarner.com)

### ■ Service-Produkte inklusive

BorgWarner Emissions Systems kennt die Kundenbedürfnisse und liefert die Original-Thermostate der Marke Wahler immer zusammen mit der passenden Dichtung!

Top OEM-  
quality

### ■ *Variety made to measure*

*BorgWarner Emissions Systems offers suitable Wahler spare parts for 62 automobile brands!*

### ■ *BorgWarner worldwide*

*BorgWarner is represented in all the world's important markets with its own subsidiaries and a dense service network. For more information, visit [aftermarket.borgwarner.com](http://aftermarket.borgwarner.com)*

### ■ *Service products included*

*BorgWarner Emissions Systems knows its customers' needs and always supplies original Wahler thermostats together with the matching gasket!*



Neben den Thermostaten umfasst das Produktportfolio auch AGR-Leitungen und AGR-Ventile. Für weitergehende Informationen fordern Sie bitte unseren Katalog Abgasrückführung an. Auf Wunsch erhalten Sie unsere drei Kataloge Thermostate und Thermoschalter für PKW, Thermostate und Thermoschalter für NFZ sowie Abgasrückführung auch in digitaler Form auf unserer Katalog-CD.

*In addition to the thermostats listed in this catalog EGR-pipes and EGR-valves complete the product portfolio. Please ask the catalog Exhaust Gas Recirculation for further information. Our three catalogues Thermostates and Thermostitches Passenger Cars, Thermostates and Thermostitches Commercial Vehicles and Exhaust Gas Recirculation are also available in digital form on our catalog CD.*

**[aftermarket.borgwarner.com](http://aftermarket.borgwarner.com)  
oder Telefon +49 711 3152-0**



## CASE / I.H.C.

Einschränkung  
Restriction\*  
Restriction\*

Thermostat  
Thermostat  
Thermostat

Kit  
Kit  
Kit

Dichtung  
Gasket  
Joint

D-155, D-179, D-206, D-239, D-310, D-358  
353, 383, 423, 453, 523, 624, 724, 824, 654  
433, 533, 553, 633, 733, 644, 743, 744, 745  
844, 844S, 946, 955, 1046, 1055, 1246  
743XL, 745XL, 844XL, 856XL, 956XL, 1056XL  
1255XL, 1455XL  
Typ 74, 84, 85 Europa 526 - 1056  
Typ 968, 975, 9078, 9086, 9094

ohne Gehäuse  
  
  
  
  
  
ohne Gehäuse

4017.82  
4017.82  
4017.82  
4017.82  
4017.82  
4017.82  
4017.82  
4512.85/1

## DAF

MX 265  
MX 300 / 340 / 375  
PE 183 C / 228 C / 265 C  
PF 183 M / PF 212 M / PF 235 M  
PR 183 S / 228 S / 265 S  
RS 180 / L / M  
RS 180 / L / M  
RS 200 / L / M  
RS 200 / L / M  
RS 222 / L / M  
RS 222 / L / M  
VF 373 M  
WS 225  
WS 242 / L / M  
WS 242 / L / M  
WS 259  
WS 268 / G / L / M  
WS 282  
WS 295 / G L / M  
WS 315 7 G / L / M  
XE 250 C / 280 C / 315 C / 355 C / 390 C  
XF 250 M / 280 M / 315 M / 355 M

4619.80  
4619.82  
4619.80  
4619.82  
4619.80  
4619.82  
  
4619.80  
4619.75  
4619.80  
4619.80  
4619.80  
4619.80  
4619.80  
4619.80  
4619.80  
  
120875  
120875  
120875  
120875  
120875  
120875  
120875  
120875  
120875  
120875  
120875  
120875  
120875  
120875  
120875  
120875  
120875  
120875  
120875  
120875

## DEUTZ / MWM

D 208, D 225  
D 226, TD 226, D 227, TD 228, D 325, D 327  
F 2 / 3 / 4 M 1008  
B 2 / 3 / 4 M 1008  
226 / B3 TD  
226

2391.75  
2393.75  
4007.80D  
4007.80D  
4512.85/1  
4512.75/1 ▲

## EVOBUS / SETRA

Serie 200 S 215  
Serie 400 S 411 / 415 / 416 / 417 / 431

2 x  
2 x

4105.83D  
4105.83D

## FENDT

FW 135, 138, 180, 181, 182, 184  
FW 238, 258, 268, 278  
F 281, 282, 283, 284, 285  
Farmer 304, 305, 306, 307, 308, 309  
Farmer 305 LS, 307 LS

3 Anschlüsse  
4 Anschlüsse

2391.75  
2391.75  
2389.75/1  
2391.75  
2393.75



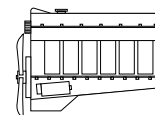

## FIAT

Einschränkung  
Restriction\*  
Restriction\*

Thermostat  
Thermostat  
Thermostat

Kit  
Kit  
Kit

Dichtung  
Gasket  
Joint

149 B1.000 / 149 B3.000		3431.80D		
169 B / 170 B / 170 D		3061.82		
182 B6.000		3163.88D		
182 B9.000 / 186 A9.000		410589.88D		
199 A2.000 / 199 A9.000		410048.88D		
223 A5.000 / 223 B1.000 / 223 B2.000		3105.87D		
223 A7.000		410589.88D		
223 A9.000		410048.88D		
280 A1.000		3431.80D		
350 A1.000		410090.88D		
4HV		3497.88D		
8140.21 / 23 / 27 / 43 / 47 / 63 / 67		4174.79D		
8140.21 / 23 / 27 / 43 / 47 / 63 / 67		4174.82D		
8144.61		4008.79D		
843 A1.000		410090.88D		
CRD93L (U25-661)		4174.82D		
D8B / D9B		4446.83D		
DHX		4446.83D		
DHX		4450.83D		
DJY		4446.83D		
DW 8 / DW 10		4446.83D		
DW10ATED4 (RHW)		4446.83D		
EW 10J4		3483.89D		
F1A E0481 C		3171.82D		
F1A E0481 N		410937.82D ▲		
F1A E3481 D		410937.82D ▲		
F1C E0481 D		410075.79D ▲		
F1C E3481 E		410075.79D ▲		
F1C E3481 M		410075.79D ▲		
F1C E3481 N		410075.79D ▲		
RFL / RFW		3136.82D50		
RFN		3483.89D		
RHV / RHW / RHX / RHZ		4446.83D		
WJZ		4446.83D		
XM7T		3061.82		
XN 1T		3061.82		
XUD9A		4446.83D		
XUD9TF		4446.83D		
XUD9TF		4450.83D		
<b>Fiat Traktor</b>				
Traktor Typ 45.66, 50.66		4008.79D		
Traktor Typ 55.46 / 56 / 66 / 88 / 90		4008.79D		
Traktor Typ 60.46 / 56 / 66 / 90 / 93 / 94		4008.79D		
Traktor Typ 65.46 / 56 / 66 / 90, 70.90		4008.79D		
Traktor Typ 80.66 / 90, 85.90, 95.90		4008.79D		
Traktor Typ 95.90		4008.79D		
Traktor Typ 100.90, 110.90, 115.90		4008.79D		
Traktor Typ 250, 420, 440, 450, 470, 474		4008.74D		
Traktor Typ 500, 540, 550, 566, 570, 580		4008.79D		
Traktor Typ 600, 640		4008.74D		
Traktor Typ 666, 670, 680		4008.79D		
Traktor Typ 766, 780		4008.79D		
Traktor Typ 980, 1000, 1180, 1280, 1300 s, 1380		4008.74D		
Traktor Serie 900 Typ 980		2391.75		
Traktor Typ 1280, 1380, 1580, 1880		4008.79D		
Traktor Typ 3435, 3935, 4135, 4635, 4835, 5635, 6635, 7635		4008.74D		

## FORD

Einschränkung  
Restriction\*  
Restriction\*

Thermostat  
Thermostat  
Thermostat

Kit  
Kit  
Kit

Dichtung  
Gasket  
Joint

4AB / 4BA / 4CA		4147.80D		
4BC / 4CC / 4DA / 4EA / 4EB / 4EC / 4ED		4270.88D		
4FA / 4FB / 4FC / 4FD		4270.88D		
4GA / 4GB / 4GC / 4GD / 4GE / 4GF		410131.88D		
4HA / 4HB / 4HC / 4HD		4270.88D		
4RB / 4RC		3021.88D50		
ABFA		3497.88D		
B		3021.88D50		
BHPA		410131.88D		
BRT		4270.80D		
CVRA / CVRB / CVRC		3497.88D		
CYFB / CYFA / CYFC / CYFD / CYRA / CYRB / CYRC		3497.88D		
D2FA / D2FB / D2FE / D3FA / D4FA / DOFA		3497.88D		
DRFA / DRFD / DRFE / DRFB / DRFC		3497.88D		
DRRC / DRRR / DRRB		3497.88D		
E5FA / E5FC / E5FA		3100.88D		
EX / EY		3021.88D50		
EYPC / EYPA / EYPD		4270.88D		
F3FA / F4FA / F1FA / FXFA		3497.88D		
FUJA / FUJB		4457.82D		
FXJB / FXJA / FYJA / FYJB	→ 09.2003	4457.82D		
FXJB / FXJA / FYJA / FYJB	09.2003 →	4483.82D		
H9FA / H9FB / H9FD		3497.88D		
HCPB / HCPA		410131.88D		
JXFC / JXFA		3497.88D		
L3C / LAT / LCR / N6T / N6TS / NAE		3021.88D50		
NAT / NAV / NAW / NAX / NBA / NCA		3021.88D50		
NSF / NSG / NSH		3100.88D		
P7PA / P7PB		410131.88D		
P8FA / P8FB		3497.88D		
P9PA / P9PB / P9PC / P9PD		410131.88D		
PGFA / PGFB / PHFA / PHFC		3497.88D		
QVFA / QWFA		3497.88D		
R2PA / R3PA / RWPA / RWPC / RWPE / RWPF / RWPD		410131.88D		
RFA		4270.88D		
RWPA		410131.88D		
SAFA / SAFB / SRFA / SRFC / SRFB / SRFE / SRFD		3497.88D		
UHFA / UHFB / UHFC / USRA / USRB		3497.88D		

## HOLDER

Typ A40, 50, 60 / Turbo		3000.83		
Typ AG 3, AG 35,		3000.83		
Typ AM 2, B 25, P 50		3000.83		

## IVECO

8040.05 / 25 / 45		4166.79D		
8060.04/ 05 / 24 / 25 / 45		4165.79D		
8140.07 / 23 / 27 / 43 / 47 / 63 / 67 / 97		4174.79D		
8140.21 / 61		4151.79D		
8140.43	Serienausführung	4174.82D		
8140.43		4174.88D ▲		
8140.61.200		4151.79D		
8210.22 / 42	2 x / Motornummer 264992 →	4165.79D		
8210.42	2 x	4163.79D		

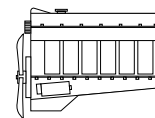

## IVECO

	Einschränkung Restriction* Restriction*	Thermostat Thermostat Thermostat	Kit Kit Kit	Dichtung Gasket Joint
8280.22		4152.79D		
8280.42.001	Motornummer 108436 →	4163.74D		
8280.42.001	Motornummer 108436 →	4163.79D		
8280.42.050		4163.74D		
8280.42.050		4163.79D		
8280.42S. TCA	2 x / Motornummer →116714	4163.79D		
8280.42S. TCA	1 x / Motornummer 116715 → 227934	4163.74D		
8280.42S. TCA	1 x / Motornummer 116715 → 227934	4163.79D		
8280.42S. TCA	2 x / Motornummer 227935 →	4163.79D		
8280.42S.342 / 352		4163.74D		
8280.42S.342 / 352		4163.79D		
8280.42S.350	2 x / Motornummer →116714	4163.79D		
8280.42S.350	1 x / Motornummer 116715 → 227934	4163.74D		
8280.42S.350	1 x / Motornummer 116715 → 227934	4163.79D		
8280.42S.350	2 x / Motornummer 227935 →	4163.79D		
8360.46		4165.79D		
8460.21 / 41	2 x	4162.79D		
8460.41	2 x	4165.79D		
F1AE0481 A / B		3171.82D		
F1AE0481 D / FA / GA / HA		410937.82D ▲		
F1AE0481 M		3171.82D		
F1CE0481 A / B		3169.79D		
F1CE0481 FA / HA / HC		410081.79D		
F2BE0681 A / B / C / D / E / F	Wasserkühlung	4619.86	410608.86D	120213
F2BE0681 A / B / C / D / E / F	Ölkühlung	4622.82D0		
F2BE0681 A / B / C / D / E / F	Ölkühlung Motornummer 13702 →		410763.82D	
F2BE1682 G	Ölkühlung	4622.82D0		
F2BE1682 G	Ölkühlung Motornummer 13702 →		410763.82D	
F2BE3681 A / B	Wasserkühlung	4619.86	410608.86D	120213
F2BE3681 A / B	Ölkühlung	4622.82D0	410763.82D	
F2BE3681 C	Wasserkühlung	4619.86	410608.86D	120213
F2BE3681 C	Ölkühlung	4622.82D0		
F2BE3681 C	Ölkühlung Motornummer 13702 →		410763.82D	
F3AE0681 B / D / E	Ölkühlung	4622.82D0		
F3AE0681 B / D / E	Ölkühlung Motornummer 14695 →		410763.82D	
F3AE3681 A / B	Ölkühlung	4622.82D0	410763.82D	
F3B3681 A	Ölkühlung	4622.82D0		
F3B3681 A	Ölkühlung Motornummer 14695 →		410763.82D	
F3B3681 B / C / D	Ölkühlung	4622.82D0	410763.82D	

## LOMBARDINI

LDW 502		4007.80D		
LDW 602		4007.80D		
LDW 702		4007.80D		
LDW 903		4007.80D		
LDW 1003		4007.80D		
LDW 1204		4007.80D		
LDW 1204/T		4007.80D		
LDW 1404		4007.80D		
LDW 1503		4007.80D		
LDW 2004		4007.80D		
LDW 2004/T		4007.80D		



MAN	Einschränkung Restriction* Restriction*	Thermostat Thermostat Thermostat	Kit Kit Kit	Dichtung Gasket Joint
D 0224 ME / MF		4150.79D50		
D 0226		4150.79D50		
D 0824 FL / LF / LFL / LFO / LOH		4150.83D50		
D 0824 GF		4150.79D50		
D 0824 LF	Automatikgetriebe	410864.79D0		
D 0824 LOH	Automatikgetriebe	410864.83D0		
D 0826 F / LF / LFL / TF	Automatikgetriebe	410864.79D0		
D 0826 F / LF / LOH / OH / TF / TOH		4150.79D50		
D 0826 GF / LF / LFL / LUH / TOH		4150.83D50		
D 0826 LOH / LUH	Automatikgetriebe	410864.83D0		
D 0834 LFL		4150.83D50		
D 0836 HM 3 U		4373.70 •		
D 0836 LF		4150.79D50		
D 0836 LF		4150.83D50		
D 0836 LOH / LUH	2 x	4150.83D50		
D 0846 HM 91 U / 95 U		4351.79		
D 2066 LF	2 x	4150.79D50		
D 2066 LF	2 x	4150.83D50		
D 2530 MF / MTE / MTXF / MXF	2 x	4150.79D50		
D 2538 M / MF / MT	2 x	4150.79D50		
D 2540 MTF	2 x	4150.79D50		
D 2555 M / MF / MX / MXF / MXUL	2 x	4150.79D50		
D 2556 M / MF / MX / MXF / MXUH / MXUM	2 x	4150.79D50		
D 2565 HM / ME / MK / MS / MT / MUH	2 x	4150.83D50		
D 2565 M / MF / MUL	2 x	4150.79D50		
D 2566 M / MF / MH / MH / MK / ML / MT / MU / UH	2 x	4150.79D50		
D 2566 MLU / MSF / MT / MXF	2 x	4150.83D50		
D 2566 MUH / UH	Automatikgetriebe	410864.83D0		
D 2658 M2	2 x	4150.83D50		
D 2676 LF / LOH	2 x	4150.83D50		
D 2840 LF / MF / MFG	2 x	4150.79D50		
D 2840 LYE / ME / MH	2 x	4150.83D50		
D 2842 LE / LXE / LYE / LZE / ME	2 x	4150.83D50		
D 2848 LXE / LYE / M / MH	2 x	4150.83D50		
D 2858 M	2 x	4150.83D50		
D 2865 LF / LOH / LU / LUH / LXF	2 x	4150.79D50		
D 2865 LF / LOH / LUH / LXF	2 x	4150.83D50		
D 2865 LF / LUH	Automatikgetriebe	410864.83D0		
D 2866 F / KF / KO / KU / LF / LO / LU / LX / T / U	2 x	4150.79D50		
D 2866 F / KF / KO / KU / LF / LO / LU / LX / T / U	2 x	4150.83D50		
D 2866 LU	2 x	4150.71D50		
D 2866 LUH / TOH / TUH / UH	Automatikgetriebe	410864.83D0		
D 2868 LF	2 x	4150.79D50		
D 2868 LF	2 x	4150.83D50		
D 2876 LF	2 x	4150.79D50		
D 2876 LF	2 x	4150.83D50		
D 2876 LOH	2 x	4150.71D50		
D 2876 LOH	2 x	4150.79D50		
D 2876 LOH	2 x	4150.83D50		
E 2866 DF / DOH	2 x	4150.83D50		
E 2866 DF / DUH	2 x	4150.79D50		
G 2866 DOH / DUH	2 x	4150.83D50		

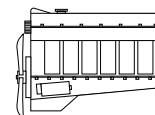

## MERCEDES BENZ

	Einschränkung Restriction* Restriction*	Thermostat Thermostat Thermostat	Kit Kit Kit	Dichtung Gasket Joint
M 102.942/943/945/946		4078.87D		
M 104.900		4123.80D		
M 111.948/950/978/980		4279.87D		
M 111.979/984		4275.87D		
M 112.951/976		4281.87D		
M 115.921/927/928/929/952/970/971		4105.83D		
M 115.955/972		4078.87D		
M 271.951		3457.90D		
M 272.978/979		4833.100D ▲		
OM 314.910/915→917/944/946/948/953/956/957/ 959/961→968		4083.83D50		
OM 314.970		4105.83D		
OM 327.910/914→919/931→946		4083.83D50		
OM 352 / OM 353		4083.83D50		
OM 352.901/904/908/915/917/930/931/936/938	Motornummer →004710	4351.79		
OM 352.901/904/908/915/917/930/931/936/938	Motornummer 004711→	4083.83D50		
OM 352.944/945/948/953/954/955/963/969/991	Motornummer →004710	4351.79		
OM 352.944/945/948/953/954/955/963/969/991	Motornummer 004711→	4083.83D50		
OM 354		4105.83D		
OM 355		4105.83D		
OM 356		4105.83D		
OM 357		4105.83D		
OM 360.911/914→918/931/933/936→949/979→ 981/984→986		4083.83D50		
OM 362		4105.83D		
OM 364		4105.83D		
OM 366		4105.83D		
OM 382.916/917/950		4105.83D		
OM 401 / 402 / 403	2 x	4105.83D		
OM 407	2 x	4105.83D		
OM 421 / 422 / 423	2 x	4105.83D		
OM 427 / 429	2 x	4105.83D		
OM 440 / 441 / 442 / 443	2 x	4105.83D		
OM 445 / 446	2 x	4105.83D		
OM 447 / 457	2 x	4105.83D		
OM 458.960/970/980	2 x	4105.83D		
OM 481.902/904	2 x	4105.83D		
OM 482.902/904	2 x	4105.83D		
OM 521.940/950	2 x	4105.83D		
OM 522.940→943	2 x	4105.83D		
OM 541.920→928/940→952/970/972/974/976	2 x	4105.83D		
OM 542.920→926/940→ 945/947/948/956/957/960/962/964	2 x	4105.83D		
OM 601.940/941/943	ohne Gehäuse	4176.85D		
OM 601.940/941/943	mit Gehäuse	4280.85D		
OM 601.942/970		4176.80D		
OM 602.940/941/948		4176.85D		
OM 602.980/982/984	ohne Gehäuse	4176.85D		
OM 602.980/982	mit Gehäuse	4280.85D		
OM 611.980/981/987	ohne Gewinde	410171.87D		
OM 611.980/981/987	mit Gewinde	411433.87D ▲		
OM 612.981	ohne Gewinde	410171.87D		
OM 612.981	mit Gewinde	411433.87D ▲		
OM 615.917/937/939		4049.80D1		
OM 616.910		4078.79D		
OM 616.913/914/937/939/963		4049.80D1		
OM 616.917/934		4049.80D		

## MERCEDES BENZ

Einschränkung  
Restriction\*  
Restriction\*

Thermostat  
Thermostat  
Thermostat

Kit  
Kit  
Kit

Dichtung  
Gasket  
Joint

OM 617.913		4049.80D1		
OM 642.896/898/992/993		4490.87D ▲		
OM 642.896/898/992/993	elektrisch beheizt	410055.87D ▲		
OM 642.990		4832.87D ▲		
OM 646.980→985/990	ohne Gewinde	410171.87D		
OM 646.980→986/989/990	mit Gewinde	411433.87D ▲		
OM 900.911→913/917→919		4105.83D		
OM 902.910/913→915		4105.83D		
OM 902.911/912/922/927		4472.83D ▲		
OM 904.904→959/961/962/964→968		4105.83D		
OM 906.910→935/937/938/940/941/944→955		4105.83D		
OM 906.936/967		4472.83D ▲		
OM 906.957→960/962→966/968/970/971/974→983/985/988		4105.83D		
OM 907.910/920/930/940/941/960/970/980/990		4105.83D		
OM 909.900/901/910/911/920/921/960/970/971		4105.83D		
OM 924.910→912/914→916/919/920/922→924		4105.83D		
OM 924.917		4472.83D ▲		
OM 926.910→912/914/915/917/918/921		4105.83D		
OM 926.916/920		4472.83D ▲		
OM 926.924→929/932/934/937→939		4105.83D		
OM 941.910/920/921/929/930/940/960/970/980/981/990		4105.83D		
OM 942.910→912/925/930/960/967/970/980		4105.83D		

## MULTICAR

028.B M 344/M 841		4256.80D		
028.B M 344/M 841		4253.87D		
Engine Iveco 8140		4174.79D		
FUMO 2.8	82° Serienausführung	4174.82D		
FUMO 2.8	88°	4174.88D ▲		
FUMO 3.0		410081.79D		
FUMO 3.0	AGR-Ventil	7631D		
FUMO 3.0	Drosselklappe	7523D		
M 25 1.9	80°	4256.80D		
M 25 1.9	87° Serienausführung	4253.87D		
M 26 1.9	80°	4256.80D		
M 26 1.9	87° Serienausführung	4253.87D		
M 26 2.5 / 2.8		4174.79D		
M26 EcoLine, Profiline, Transline	79° Serienausführung	4174.79D		
M26 EcoLine, Profiline, Transline	82° Serienausführung	4174.82D		
M26 EcoLine, Profiline, Transline	88°	4174.88D ▲		
TREMO Carrier, Carrier S		4264.87D		
TREMO Carrier, Carrier S	AGR-Ventil	7283D		
TREMO 501	Motor AFD / AVM	4264.87D		
TREMO 601	Motor OM 601	4176.85D		
UX 100 OM 602	ohne Gehäuse	4176.85D		
UX 100 OM 602	mit Gehäuse	4280.85D		

## PEGASO

9105 / 9220		4078.75D		
9156		4619.75		
200CV / 200CV TURBO / 260CV		4078.75D		
300 CV → 400 CV (TRONER)		4619.75		



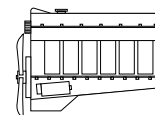

## PEUGEOT

	Einschränkung Restriction* Restriction*	Thermostat Thermostat Thermostat	Kit Kit Kit	Dichtung Gasket Joint
169B (XM7T) / 170 (XN1T) / 170B (XN1T) / 170D (XN1TACP)		3061.82		
169B (XM7T) / 170 (XN1T) / 170B (XN1T) / 170D (XN1TACP)		3061.88		
4HU 4HU (P22DTE) / 4HV (P22DTE)		3497.88D		
8140.43		4174.82D		
8140.43		4174.88D ▲		
CRD93 (U25/661) / CRD93LS (U25/673)		3033.84D		
DJ5 / DJ5 T / DJ5 TED		410058.84D		
DW10 ATED		4446.83D		
DW10 BTED		4446.83D		
DW10 TD		4446.83D		
DW10 UTD		4446.83D		
DW12 UTED		4446.83D		
EW10 A		3483.89D		
EW10 J4		3483.89D		
F1CE0481D (FG30DT)		410075.79D ▲		
XB5P / XC5P / XC7P / XD2P94 / XDP88 / XDP90 / XM7P / XN1P		3053.75		
XD3P		4147.80D		
XM7T		3061.82		
XM7T		3061.88		
XN1T		3061.82		
XN1T		3061.88		
XU10 J2		3136.82D50		
XU10 J2		3136.82D50		
XUD7 / XUD9 A		4446.83D		
XUD9 AU		4446.83D		
XUD9 TE		4450.83D		
XUD9 UT		4450.83D		
XUD9 UTF		4450.83D		

## RENAULT

8140.07 / 21 / 23 / 27 / 43 / 47 / 63 / 67		4174.79D		
8140.21 / 23 / 27 // 43 / 47 / 61 / 67		4151.76D		
829 730 / 731		4122.87D		
841 705		3053.85		
847 700 / 701		3029.86		
852 720 / 750		4147.80D		
A1M 705 / A1M 707 / A1M 708		3053.85		
C1J700		3029.86		
dCi 11-270	→ 06.2003	410828.86D0	410828.86D	120875
dCi 11-270	06.2003 →	4619.86		120875
dCi 4B / 4C	06.2003 →	4619.86		120875
dCi 4B / 4C	→ 06.2003	410828.86D0	410828.86D	120875
dci 6A / 6W	06.2003 →	4619.86		120875
dci 6A / 6W	→ 06.2003	410828.86D0	410828.86D	120875
F1N 720 / 722 / 724		3470.89D50		
F4R 720 / 722 / 820		3466.89D		
F8Q 606	Einsatzthermostat	3470.89D50		
F8Q 606	mit Gehäuse	410530.89D ▲		
F9Q 760 / 762		410517.83D		
F9Q 770	ab Motor 000529	3470.89D50		
F9Q 772 / 774		410517.83D		
J5R 716 / 718 / 726 / 728		4122.87D		
J7T 600 / 780 / 782 / 788		4122.87D		
J8S 330 / 620 / 758		4147.80D		

## RENAULT

	Einschränkung Restriction* Restriction*	Thermostat Thermostat Thermostat	Kit Kit Kit	Dichtung Gasket Joint
M9R 630 / 692 / 780 / 782 / 786		411476.83D ▲		
MACK E.TECH A / B / C 46		411045.82D		120875
MDS 06.35.40		4596.83D		
MIDR 04.02.26		410828.86D0	410828.86D	120875
MIDR 04.02.26		410828.82D0	410828.82D	120875
MIDR 06.02.12		410828.86D0	410828.86D	120875
MIDR 06.02.12		410828.82D0	410828.82D	120875
MIDR 06.02.26		410828.82D0	410828.82D	120875
MIDR 06.02.26		410828.86D0	410828.86D	120875
MIDR 06.20.30 A		4596.83D		
MIDR 06.20.45		4596.83D		
MIDR 06.23.56		4596.83D		
MIDR 06.24.65 A / B / C		411045.82D		120875
MIDR 06.24.65 H / J / L / M / N / P	(2 x 4596.83 + gasket)	410758.83D		
MIDR 06.35.40 / C / G		4596.83D		
MIDS 06.02.12		410828.82D0	410828.82D	120875
MIDS 06.02.12		410828.86D0	410828.86D	120875
MIDS 06.20.30		4596.83D		
MIDS 06.20.45		4596.83D		
MIDS 06.35.40		4596.83D		
MIVR 08.35.30	2 x	4596.83D		
MIVS 08.35.30	2 x	4596.83D		
S8U 720 / 722 / 750 / 752 / 770 / 772		4174.79D		
S8U 731		4008.79D		
S8U 731		4174.79D		
S8U 742		4008.79D		
S8U 758 / 780		4151.76D		
S9W 700 / 702		4174.79D		
S9W 702		4174.79D		
Traktoren 50, 60, 70, 80		2393.75		
Traktoren 351, 421, 461, 462		2393.75		
Traktoren 551, 556, 651, 652, 656		2393.75		
Traktoren 751, 752, 781, 851, 891, 981		2393.75		
Traktoren 1181		2393.75		

## SAURER

CKT, C2 K, C2K-T		4530.80		
DA, DC, DCL, DAU, DCU, DCUL, DKU-D1 KUL		4030.70		

## SCANIA

D 8 / DN 8 / DS 8		4520.80D		
DN 9 / DS 9 / DSC 9.01 / 02 / 07-10		4520.80D		
DC 9 / DSC 9.11 / 12 / 13 / 15 Typ Serie 4		4224.80D		
D 11 / DN 11 / DS 11 / DSC 11 / DTC 11		4520.80D		
DC 11 / DSC 11	ohne Retarder	4223.83D		
DC 11 / DSC 11	mit Retarder	4224.80D		
OSC 11.03	ohne Retarder	4223.83D		
OSC 11.03	mit Retarder	4224.80D		
DC 12 / DSC 12 / DT 12	ohne Retarder	4223.83D		
DC 12 / DSC 12 / DT 12	mit Retarder	4224.80D		
DC 13	ohne Retarder	411004.80D		
DC 13	mit Retarder	4224.80D		
D 14 / DS 14 / DSC 14		4520.80D		
DSC 14.13 / 15 Typ Serie 4	ohne Retarder	4223.83D		
DSC 14.13 / 15 Typ Serie 4	mit Retarder	4224.80D		
DSI 14	ohne Retarder	4223.83D		

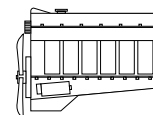

## SCANIA

	Einschränkung Restriction* Restriction*	Thermostat Thermostat Thermostat	Kit Kit Kit	Dichtung Gasket Joint
DSI 14	mit Retarder	4224.80D		
DC 16	ohne Retarder	4223.83D		
DC 16	mit Retarder	4224.80D		
DT 16.08		4224.80D		
Bus Serie 3 K 93, K 113, L 113		4520.80D		

### Industrie:

DC 9A		4223.75D		
DC 9A		4223.83D		
DSI 11 EO1		4520.80D		
D 12 / D 12 M		4223.75D		
D 12 / D 12 M		4223.83D		
DI 12		4223.75D		
D 16 M		4223.75D		

### Dichtung / Gasket / Joint

#### für / for / pour

4223.75D / 4223.83D		122689		
4224.75D / 4224.80D / 411004.80D		122690		

## STEYR

WD 311.40 / 41		4368.87		
WD 411.41 / 42 / 43 / 44 / 45 / 46 / 85 / 86 / 87 / 88 / 89		4368.87		
WD 611.40 / 41 / 42 / 43 / 85 / 86 / 87 / 88		4368.87		
WD 815.60 / 70		410864.79D0		

### Traktor

Typ 8060, 8070, 8075, 8080, 8090		4368.87		
Typ 8100, 8110, 8120, 8130		4368.87		
Typ CS 68, 78, 86		4512.85/1		
Typ CS 75 → DBD 002 3065		4512.85/1		
Typ CS 94 → DBD 001 0601		4512.85/1		

## VOLKSWAGEN

1 E / 1G / 1S		4123.80D		
1F / 1X / 1Y / 1Z		4264.87D		
2L		3477.88D		
2Y / 4Y		4103.82D		
AAB / AAF / ACU / ACV / AEN / AET / AEU		4116.87D1		
AAC / ABL / AEF / AEY		4264.87D		
ACL / ACT / AES		4123.80D		
AEE / AEX		3143.87D	410989.87D ▲	
AGK / ATA / AUH		3145.79D		
AGL		4275.87D		
AGX / AHD		4116.87D1		
AHB / AHU		4264.87D		
AHY / AJA / AJT		4116.87D1		
AKV		3143.87D		
ALE / ALH		4264.87D		
AMV		4123.80D		
AMV		4455.80D		
ANJ / APA / APL / AUF		4116.87D1		
APQ / AUA / AUD		3143.87D	410989.87D ▲	
ATA / AUH		3145.79D		
AVR / AVT		4116.87D1		



## VOLKSWAGEN

Einschränkung  
Restriction\*  
Restriction\*

Thermostat  
Thermostat  
Thermostat

Kit  
Kit  
Kit

Dichtung  
Gasket  
Joint

AXA		3141.87D		
AXB / AXC / AYQ		4264.87D		
AXD / AXE		4430.87D		
AXG / AXL / AYC / AYY		4116.87D1		
BBE / BBF / BJK / BJJ / BJL / BJM		4116.87D1		
BCA / BUD		3143.87D	410475.87D ▲	
BCQ		3145.79D		
BDJ / BJB / BRR / BRS / BST		4264.87D		
BDL / BKK		4455.80D		
BGU / BSE / BSF / BSX		3141.87D		
BLJ / BNZ / BPC		4430.87D		
BLS / BMM / BSU		4820.87D		
CAYD / CAYE		410845.92D ▲		
CEBA / CEBB / CECA / CECB		4116.87D1		
CFHC / CFHE / CFHF / CFJA / CLCA / CLCB		410845.87D ▲		
CG / CH		4006.82D		
CHGA		3141.87D		
CS		4253.87D		
DF / DG / DH / DJ / GW / MV / SR / SS		4155.87D		
DL / DW / DV		4123.80D		
EM / EW / JB / JH		4264.87D		
JK / ME		4253.87D		
JX / KY		4256.80D		
PD		4253.87D		
SR / SS		4155.87D		

## VOLVO

D 6 A / D 12 A / C		4619.86		
D 16 A / B		4619.86		
TD 40 A / 41 G		4038.81D		
D 50 A / B		4038.76D		
TD 50 A / B		4038.76D		
D 60 A / B		4038.81D		
D 70 A / B		4038.81D		
TD 60 A / B / C		4038.81D		
TD 61 F / G / E		4619.82		
TD 61 F / G / E		4619.86		
TD 63 E		4619.86		
TD 70 A / B / C / D / E / F / G		4038.81D		
TD 70 G		4619.82		
TD 71 F		4619.82		
TD 73 E		4619.82		
D 100 A / B		4038.76D		
D 100 A / B		4038.81D		
HD 100 A / D		4038.76D		
HD 100 A / D		4038.81D		
TD 100 A / B		4038.76D		
TD 100 A / B / C / G		4038.81D		
THD 100 A / D / E		4038.81D		
TD 101 F / G		4619.82		
THD 101 G / K		4619.82		
TD 102 F / TD 103 E		4619.82		
TD 102 F / TD 103 E		4619.86		
TD 120 A		4038.76D		
TD 120 A / C / D / E / F / G		4038.81D		
TD 121 F / G		4619.82		
TD 122 E / F		4619.82		

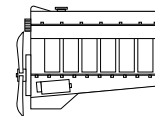

## VOLVO

Einschränkung  
Restriction\*  
Restriction\*

Thermostat  
Thermostat  
Thermostat

Kit  
Kit  
Kit

Dichtung  
Gasket  
Joint

TD 123 E

4619.82

TD 162 F

4619.82

TD 162 F

4619.86

TD 163 ES

4619.82

TD 163 ES

4619.86

## ZETOR

Typ 8011, 8045, 12011, 12045

4030.78

# Vergleichsliste | Cross References

Hersteller Manufacturer Réf. Constructeur	Hersteller-Nr. Manufacturer's Ref. Réf. Constructeurs	Wahler-Nr Wahler-ref. Réf. Wahler	Hersteller Manufacturer Réf. Constructeur	Hersteller-Nr. Manufacturer's Ref. Réf. Constructeurs	Wahler-Nr Wahler-ref. Réf. Wahler	
AGCO	X815.090.002.000	2391.75		077 121 113 C	4274.82D	
				078 121 113 C	4274.87D	
ALFA ROMEO	105.00.01.064.00	3000.83		078 121 113 F	4274.87D	
	105.00.01.064.01	3000.83		078 121 113 G	4274.92D	
	5177 0698	411193.82D		078 121 113 H	4274.92D	
	5520 2510	410049.88D		078 121 113 J	4274.87D	
	5521 5006	410871.80D ▲		191 959 481 A	6017.95D	
	6050 4230	4003.86		191 959 481 B	6020.95D	
	6051 6212	4160.83D		191 959 481 C	6017.95D	
	6066 3619	410590.88D		1H0 959 481	6037.95D	
	6071 0617	3067.83		1H0 959 481 B	6037.95D	
	6071 3535	4008.79D		251 959 481	6017.95D	
	6081 5681	410512.88D		251 959 481 G	6087.87D	
	6081 6681	410511.88D		251 959 481 H	6087.87D	
	7175 4778	410049.88D		251 959 481 K	6087.87D	
	761 5234	4022.82D1		321 959 481 A	6017.95D	
				321 959 481 C	6017.95D	
ASTON MARTIN	52 06 139	3004.82		321 959 481 D	6017.95D	
				321 959 481 E	6020.95D	
AUDI	022 121 113	4455.80D		6U0 959 481 A	6017.95D	
	025 121 113 D	4155.87D		811 959 481	6024.95D	
	025 121 113 E	4155.87D		823 959 481	6010.92D	
	025 121 113 F	4155.87D		823 959 481 A	6010.92D	
	030 121 113 B	4264.84D		823 959 481 F	6010.92D	
	032 121 110 B	3143.87D		823 959 481 G	6010.95D	
	032 121 110 F	3167.83D		823 959 481 L	6010.92D	
	032 121 110 L	410475.87D		867 959 481	6039.95D	
	032 121 110 P	3143.87D		893 959 481	6024.95D	
	032 121 121 G	410475.87D				
	032 121 121 K	410475.87D		AUTOBIANCHI	415 4313	3023.87D
	035 121 113	4088.80D			421 8649	3345.79
	035 121 113 B	4088.87D			426 3997	6010.95D
	036 121 113	3091.92D			4355 8460	4091.82D
	036 121 113 A	3091.92D			4409 2540	4091.82D
	036 121 113 B	3091.92D			7545 9580	3105.87D
	03G 121 111 A	4820.87D			7581 3190	3105.87D
	03G 121 113	3472.87D				
	03G 121 113 A	4820.87D		BMW	11 51 7 500 597	410793.95D
	03L 121 111 AE	410845.87D			11 53 0 139 877	4326.97D
	03L 121 111 R	410845.92D			11 53 1 247 125	410792.95D
	03L 121 111 S	410845.92D			11 53 1 251 041	4231.80D
	03L 121 113 B	410537.92D			11 53 1 253 248	3344.80
	03L 121 114 B	410536.92D			11 53 1 253 249	3344.80
	044 121 113	4264.87D			11 53 1 254 065	4231.80D
	050 121 113 C	3141.87D			11 53 1 260 720	3344.75
	052 121 113 A	3091.92D			11 53 1 264 668	4232.80D
	056 121 113 A	4256.80D			11 53 1 265 085	4232.80D
	056 121 113 D	4264.87D			11 53 1 265 086	4232.71
	059 121 113 A	4006.82D			11 53 1 312 288	4619.80
	059 121 113 B	4006.82D			11 53 1 315 063	4619.80
	068 121 113 H	4253.87D			11 53 1 318 274	4621.80D
	069 121 113	4116.87D1			11 53 1 432 881	410792.95D
	06D 121 111 G	411186.87D			11 53 1 436 042	411573.105D ▲
	06F 121 111 F	411187.87D			11 53 1 436 823	4326.97D
075 121 113 D	4123.80D			11 53 1 437 040	4326.97D	
077 121 113	4274.87D			11 53 1 437 085	411573.105D ▲	
077 121 113 B	4274.87D			11 53 1 466 174	4235.71D	



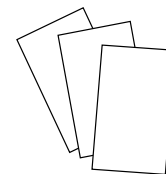

Hersteller Manufacturer Réf. Constructeur	Hersteller-Nr. Manufacturer's Ref. Réf. Constructeurs	Wahler-Nr Wahler-ref. Réf. Wahler	Hersteller Manufacturer Réf. Constructeur	Hersteller-Nr. Manufacturer's Ref. Réf. Constructeurs	Wahler-Nr Wahler-ref. Réf. Wahler	
	11 53 1 485 847	410263.91D		90 411 948	4177.92D	
	11 53 1 501 173	410263.91D		92 062 728	4189.87D	
	11 53 1 702 279	4519.95D		92 067 408	4189.87D	
	11 53 1 704 704	4594.90D		96 143 939	3017.87D2	
	11 53 1 710 056	4516.85D	<b>CHRYSLER</b>	04494 469	3000.90	
	11 53 1 710 953	4235.80D		04778 975	4158.80D	
	11 53 1 712 043	4238.92D		0489 2642 AC	410871.80D ▲	
	11 53 1 713 040	4235.80D		3156283	3000.83	
	11 53 1 720 033	4516.85D		4693 117 AA	410263.91D	
	11 53 1 720 306	4516.85D		4778 975	4158.80D	
	11 53 1 721 002	4236.88D		5098 918 AA	4281.87D	
	11 53 1 721 003	4236.88D		5202 8185 AB	3000.90	
	11 53 1 727 145	4237.80D		52028185	3000.90	
	11 53 1 729 720	4516.85D		5278 144 AA	410262.91D	
	11 53 1 729 841	4516.85D		6801 3949 AA	4833.100D	
	11 53 1 731 486	4516.70D		MD 194988	410180.82D	
	11 53 1 733 803	4236.92D		T 069 7157	4147.80D	
	11 53 1 739 755	410792.95D				
	11 53 1 743 528	4238.92D		<b>CITROËN</b>	1336 A7	3431.80D
	11 53 1 743 542	4238.92D			1336 AA	410075.79D ▲
	11 53 2 243 126	4237.80D			1336 N5	3463.89D
	11 53 2 244 151	4237.80D			1336 Q1	3463.89D
	11 53 2 246 199	4237.80D			1336 Q2	410184.89D
	11 53 2 246 825	4237.88D	1336 Z0		410705.89D	
	11 53 7 502 779	4508.105D	1337 26		3053.75	
	11 53 7 509 227	4326.97D	1338 11		3136.88D50	
	11 53 7 510 959	4337.105D	1338 21		4821.89D	
	11 53 7 511 083	4236.92D	1338 23		4446.83D	
	11 53 7 511 580	4236.88D	1338 26		4450.89D	
	11 53 7 536 655	410086.97D0	1338 38		410058.84D	
	11 53 7 544 788	410086.97D0	1338 39		4450.83D	
	11 53 7 549 476	410086.97D0	1338 44		3136.88D50	
	11 53 7 550 172	410087.97D0	1338 71		4447.85D	
	11 53 7 552 403	411574.102D ▲	1338 72		4447.80D	
	11 53 7 586 885	4508.105D	1338 90		4174.82D	
	11 53 7 596 787	410263.91D	1338 A0		3483.89D	
	11 53 7 601 158	410766.103D0 ▲	1338 F5		3497.88D	
	11 53 7 791 072	410231.82D	5454410R		3033.78D	
	11 53 9 055 587	3344.80	5474546	6010.88D		
	13 54 1 730 682	7129.00D ▲	5490459C	3033.78D		
			75441833	3033.78D		
<b>BUGATTI</b>	271990009-00	4618.70	79 100 111 01	3136.82D50		
	271990003-00	4618.82	79 100 118 73	3053.75		
<b>BUICK</b>			79 100 118 80	3136.88D50		
	93235636	410520.92D ▲	79 100 143 90	3136.82D50		
<b>CATERPILLAR</b>			79 100 165 60	3136.82D50		
	4 N 6958	4256.80D	91 500 723	3061.82		
	4 N 6959	4256.80D	93 501 145	4147.80D		
	9 L 9119	4256.80D	93 501 386	4147.80D		
	9 L 9652	4256.80D	95 492 929	3033.78D		
	9 N 5020	4256.80D	95 495 311	3033.84D ▲		
	9 N 5065	4256.80D	96 006 231	4821.89D		
	9 N 5121	4256.80D	96 049 146	3136.88D50		
	9 N 5488	4256.80D	96 050 286 80	3136.88D50		
<b>CHEVROLET</b>			96 057 136	3136.88D50		
	606 203 02 75	4176.85D	96 058 051	4447.85D		
	9 698 4104	4431.105D	96 108 092	4450.89D		

# Vergleichsliste | Cross References

Hersteller Manufacturer Réf. Constructeur	Hersteller-Nr. Manufacturer's Ref. Réf. Constructeurs	Wahler-Nr Wahler-ref. Réf. Wahler	Hersteller Manufacturer Réf. Constructeur	Hersteller-Nr. Manufacturer's Ref. Réf. Constructeurs	Wahler-Nr Wahler-ref. Réf. Wahler
CITROËN	96 118 108	4447.80D	DODGE	9011 0080	410864.83D0
	96 145 00 980	410058.84D		5080 146 AB	410171.87D
	96 159 513	4147.80D		F 150.204.050.011	2391.75
	96 160 901	4446.83D		F 281.200.050.020	2389.75/1
	96 171 780 80	3136.82D50			
	96 300 66 780	3463.89D			
	96 300 666 80	3483.89D			
DACIA	77 00 101 179	126104 ▲	FIAT	83 129 996 050	4105.83D
	77 00 866 387	126104 ▲		F 150 204 050 10	2391.75
	77 00 872 554	3466.89D		F 150 204 050 11	2391.75
	82 00 374 994	411043.89D		F 281 200 050 20	2389.75/1
	82 00 400 554	411039.83D		X 815 090 002 000	2391.75
	82 00 558 758	411039.83D		X 815 090 003 000	2389.75/1
	82 00 558 783	411043.89D			
	82 00 561 420	126104 ▲		13 0707 7080	6031.88D
	82 00 660 882	3166.89D		2828 6103	6010.92D
	82 00 772 985	3466.89D		406 2141	3000.83
	82 00 954 288	411039.83D		406 2172	3000.83
DAEWOO	110 200 03 15	4276.87D	406 5540	3000.83	
	606 203 02 75	4176.85D	408 6415	3000.83	
	90 354 822	4144.92D	411 4572	6010.92D	
	90 411 948	4177.92D	413 8169	3000.83	
	92 061 279	4180.82D	415 4312	3023.87D	
	92 062 728	4189.87D	415 4313	3023.87D	
	92 067 408	4189.87D	4218 6500	3345.79	
	96 143 939	3017.87D2	422 0309	4033.82D	
			423 5333	6010.92D	
			423 5533	6010.92D	
DAF	075 0562	4619.80	424 0878	6010.92D	
	129 3885 / F75-85-95	411133.80D	426 3597	6010.92D	
	166 1375 / CF 75	411135.87D	434 0878	6010.95D	
	168 4900 / CF 75	411135.83D	435 1196	4091.82D	
	225 070	3029.83	440 9254	4091.82D	
	295 024	4619.80	443 7481	4033.82D	
	750 562	4619.80	4641 7962	410515.88D	
			4646 4992	3481.88D	
DAIHATSU	90048-33021-000	3119.88	4646 6123	4247.80D	
	90048-33029-000	4126.88	4647 7717	6035.92D	
	90048-33047	410182.84D	465 5782	4008.74D	
	90048-33056	410182.84D	4651 3506	3481.88D	
	90048-33078	410179.84D	4652 0219	6031.97D	
	90048-33083	410179.84D	4652 0785	410513.88D	
	90048-33088	410201.80D	4652 2664	3163.88D	
	90048-33092	410179.84D	4652 3118	3151.87D	
	90916-03040-000	3119.82	4652 3733	3481.88D	
	90916-03046-000	4103.82D	4652 5581	4246.80D	
	90916-03090-000	3478.82D	4653 6104	3164.88	
DETROIT DIESEL	8929878	4619.86	4654 6375	410512.88D	
			467 4169	4008.74D	
DEUTZ-FAHR	0117 2667	4094.71/1	4673 7644	3151.87D	
	0117 2668	4094.71/1	4675 8586	410591.88D	
	1227 0073	2393.75	4677 6216	3481.88D	
	1227 0074	2391.75	4677 6217	3163.88D	
	1285 0152	4007.80D	4677 6218	3164.88	
	1285 1663	4007.80D	4678 5392	410589.88D	
			4679 0294	410511.88D	
		4680 4764	410994.88D		

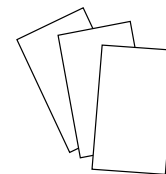

Hersteller Manufacturer Réf. Constructeur	Hersteller-Nr. Manufacturer's Ref. Réf. Constructeurs	Wahler-Nr Wahler-ref. Réf. Wahler	Hersteller Manufacturer Réf. Constructeur	Hersteller-Nr. Manufacturer's Ref. Réf. Constructeurs	Wahler-Nr Wahler-ref. Réf. Wahler
	4681 8413	3431.80D		762 5346	3431.80D
	470 3624	4008.74D		762 5347	3431.80D
	470 3625	4008.74D		762 6622	3361.87D
	475 0024	4008.79D		762 8417	3360.87D
	482 3226	4008.74D		762 8527	3355.80D
	482 6602	4151.76D		762 8799	6033.88
	5 0032 9622	4174.82D		765 5732	6035.92D
	50 415 0562	410081.79D		765 6384	3373.80D
	547 4546	6010.88D		765 6385	3373.80D
	5518 7784	410049.88D		765 6567	4022.82D1
	5519 3669	410090.88D		769 2450	3383.87
	5519 4029	410090.88D		769 6535	3383.87
	5519 4271	410048.88D		772 1399	4434.80D
	5519 9402	410588.88D		772 2107	3485.87D
	5520 2176	410090.88D		772 9959	410007.87D
	5520 2373	410048.88D		774 1883	3302.80D
	5520 2510	410049.88D		774 8867	6031.92D
	5520 3388	410049.88D		775 9596	3484.87D
	5521 5006	410871.80D ▲		777 0236	4436.80D
	5523 9819	410090.88D		777 0416	3301.80D
	592 1206	410692.71D		777 3790	410956.83D
	594 2240	3355.80D		779 1178	410516.88D
	595 0116	3159.82D		779 4132	3300.80D
	595 1985	6016.92		779 4218	410513.88D
	595 1987	6016.92		8242 0013	6031.92D
	595 8828	6033.88		8243 6410	6031.92D
	596 6787	3361.87D		8246 5533	6031.92D
	596 9749	3361.87D		8247 7919	6031.92D
	599 2746	6031.92D		907 0701	6031.92D
	6056 4101	6031.92D		9150 0723 80	3061.82
	6065 3946	410514.88D		9616 0901 80	4446.83D
	6080 8223	6031.92D		9616 0902 80	4450.83D
	6081 4382	410514.88D		9617 1780 80	3136.82D50
	708 3256	410520.92D ▲		9845 0800	3103.79
	7173 9800	4357.92D		9846 3637	4174.79D
	7174 2133	410229.82D		9849 8831	3116.82D
	7174 4389	4431.105D			
	7175 4778	410049.88D	FORD	0 801 587	4256.87D50
	7177 0832	4431.105D		1 001 993	4270.88D
	730 3174	4151.79D		1 002 788	4264.87D
	730 3615	4151.79D		1 007 754	4457.82D
	7350 2809	411193.82D		1 018 799	4123.80D
	754 0318	4022.82D1		1 031 881	4264.87D
	754 5958	3105.87D		1 032 249	4123.80D
	755 4544	3383.87		1 086 282	410131.88D ▲
	756 4583	3159.82D		1 096 283	3497.88D
	757 0837	6031.97D		1 096 699	4264.87D
	757 6281	6040.88		1 211 553	4457.82D
	758 1200	3109.87D		1 303 374	4457.82D
	758 1201	3109.87D		1 306 004	4483.82D
	758 9135	3105.87D		1 345 512	4825.98D
	7581 635	3109.82D		1 351 716	4825.98D
	759 7659	3431.80D		1 452 357	3004.88D1
	759 9824	3431.80D		1 472 378	3004.92D1
	761 3433	3378.80		1 473 089	410016.98D
	761 5234	3159.82D		1 473 090	410016.98D
	761 5235	3159.82D		1 497 689	3021.88D50

# Vergleichsliste | Cross References

Hersteller Manufacturer Réf. Constructeur	Hersteller-Nr. Manufacturer's Ref. Réf. Constructeurs	Wahler-Nr Wahler-ref. Réf. Wahler	Hersteller Manufacturer Réf. Constructeur	Hersteller-Nr. Manufacturer's Ref. Réf. Constructeurs	Wahler-Nr Wahler-ref. Réf. Wahler
FORD	1 509 953	3021.88D50	GM	800 572	3021.88D50
	1 517 858	3021.88D50		800 573	3021.88D50
	1 518 627	3004.74		800 574	3021.88D50
	1 520 969	3021.88D50		81SF 8575 EA	3021.88D50
	1 607 993	3004.74		81SF 8575 FA	3021.88D50
	1 612 191	4147.80D		84FF 8575 BA	4256.87D50
	1 635 905	3021.88D50		85HF 8575 AA	3021.88D50
	1 649 194	3021.88		891F 8575 AA	3004.88D1
	1 663 819	4270.88D		89BM 8575 AC	3004.92D1
	1 712 228	4483.82D		89BM 8575 AD	3004.92D1
	3 257 449	3119.88		89FF 8575 AA	4270.88D
	3 396 924	4639.82D		89FF 8575 AB	410131.88D
	3 599 763	4639.82D		89TM 8575 AA	4270.88D
	3 893 570	4639.82D		91XM 8575 AA	3021.88D50
	3 902 514	4639.82D		928M 8575 AE	4270.88D
	4 176 181	4639.82D		948M 8575 AA	4270.88D
	4 188 498	4639.82D		95VW 8575 AB	4264.87D
	4 356 548	3100.92D ▲		95VW 8575 AC	4264.87D
	4M5G 6L721 GA	4825.98D		95VW 8B607GA	6037.95D
	4M5G 6L721 GB	4825.98D		95WM 8575 AA	3100.88D
	4M5G 8575 ZA	4483.82D		96MM 8575 A1A	4457.82D
	4M5G 8575 ZB	4483.82D		96MM 8575 BD	4457.82D
	5 004 887	3021.88D50		96MM 8575 BE	4457.82D
	5 004 890	3004.92D1		F42Z 8575 BA	4639.82D
	5 004 891	3004.92D1		KL01 15 171 A	4639.82D
	6 058 444	4256.92D50		XM34 8575 AA	4639.82D
	6 058 784	3053.75		XM34 8575 AB	4639.82D
	6 072 016	6010.95D		XS7Q 8575 AA	3497.88D
	6 077 895	6010.95D		YU3E 8575 BA	3100.92D
	6 077 896	6010.95D			
	6 077 897	6010.95D		02 898 440	3054.92D50
	6 077 898	6010.95D		02 898 688	3054.87D50
	6 077 985	6010.95D		08 966 483	4255.82D
	6 085 917	3021.88D50		08 966 485	4255.87D
	6 085 918	3021.88D50		12 615 097	411193.82D
	6 100 372	4256.87D50		12 622 410	411193.82D
	6 100 629	3021.92D50		12 992 692	4459.92D
	6 100 630	3021.88D50		21 018 811	411193.82D
	6 106 381	4256.87D50		24 405 922	4431.105D
	6 124 378	4256.87D50		24 420 652	4175.92D
	6 144 361	6010.88D		24 420 728	4297.92D
	6 153 501	4270.88D		24 435 781	4201.92D
	6 169 774	410131.88D		24 447 862	4433.92D
	6 176 366	4256.87D50		24 456 401	411578.92D ▲
	6 182 480	4147.80D		55 182 499	410588.88D
	6 201 207	3021.88D50		55 202 510	410049.88D
	6 201 247	3021.88D50		55 577 072	4431.105D
6 526 879	3004.92D1	9 108 106	4151.76D		
6 588 962	4270.88D	9 110 719	3470.89D50		
6 758 566	3100.92D	9 112 305	410517.89D		
6 866 389	4270.88D	9 128 786	4207.92D		
6 994 257	3100.88D	9 129 907	4242.92D		
691F 8575 BA	3004.92D1	9 161 123	4174.79D		
7 072 643	4158.80D	9 543 786	4193.92D		
7 215 818	6037.95D	90 009 956	4115.92D		
7S7G 6L721 AA	410016.98D	90 067 918	4255.92D		
7S7G 6L721 AB	410016.98D	90 108 636	6010.95D		



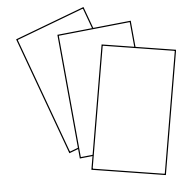

Hersteller Manufacturer Réf. Constructeur	Hersteller-Nr. Manufacturer's Ref. Réf. Constructeurs	Wahler-Nr Wahler-ref. Réf. Wahler	Hersteller Manufacturer Réf. Constructeur	Hersteller-Nr. Manufacturer's Ref. Réf. Constructeurs	Wahler-Nr Wahler-ref. Réf. Wahler
	90 156 558	4115.92D			
	90 200 836	3017.92D2	<b>HOLDER</b>	111 727	3000.83
	90 220 435	4164.92D		HD 035 A01	3000.83
	90 232 012	4144.92D			
	90 242 277	6031.100D	<b>HONDA</b>	19300-P08-014	410224.78D
	90 277 288	6031.105D		19300-PA0-003	3119.82
	90 352 677	4168.92D		19300-PB2-003	3119.82
	90 354 822	4164.92D		19300-PB2-004	3119.82
	90 357 303	6031.88D		19300-PB2-013	3119.82
	90 410 665	4144.82D		19300-PB2-014	3119.82
	90 410 897	4175.92D		19300-PB2-024	3119.82
	90 411 948	4177.92D		19300-PB2-811	3119.82
	90 412 901	4178.92D		19300-PB2-812	3119.82
	90 443 472	4164.92D		19300-PB2-815	3119.82
	90 443 473	4144.82D		19300-PB2-816	3119.82
	90 486 128	4180.82D		19300-PB2-817	3119.82
	90 501 081	4183.92D		19300-PDA-E01	410224.78D
	90 501 699	4183.82D		19300-PE0-013	4269.78D
	90 502 201	4175.92D		19300-PE0-024	4269.78D
	90 509 110	4237.80D		19300-PJ7-003	410224.78D
	90 529 846	4188.92D		19300-PJ7-004	410224.78D
	90 536 262	411578.92D ▲		19300-PLZ-004	4269.78D
	90 536 501	411578.92D ▲		19300-PM3-003	410224.78D
	90 537 453	411193.82D		19300-PM3-004	410224.78D
	90 537 605	411193.82D		19300-PR3-003	410224.78D
	90 537 811	411193.82D		19300-PT0-003	410224.78D
	90 570 620	4459.92D		19300-PT0-004	410224.78D
	90 572 899	4198.92D		19301-P07-306	410224.82D
	90 573 326	4208.92D		19301-P07-316	410224.82D
	90 573 926	4201.92D		19301-P08-000	410224.78D
	91 153 670	4158.80D		19301-P08-305	410224.78D
	91 159 950	3466.89D		19301-P08-306	410224.78D
	91 160 168	410517.83D		19301-P08-315	410224.78D
	91 160 216	126104 ▲		19301-P08-316	410224.78D
	9158251	411579.92D ▲		19301-P10-307	410224.78D
	92 063 300	4177.92D		19301-P1K-307	410224.78D
	92 063 300	4194.92D		19301-PAA-305	410224.78D
	93 177 343	410588.88D		19301-PAA-306	410224.78D
	93 179 136	410049.88D		19301-PDF-305	410224.78D
	93 181 245	411578.92D ▲		19301-PLC-305	410224.78D
	93 19 3581	410588.88D		19301-PLC-315	410224.78D
	93 198 017	410517.83D		19301-PNA-003	410225.78D
	93 198 035	411476.83D ▲		19301-PWA-305	410224.82D
	93 198 289	411476.83D ▲		19301-PZA-305	410224.82D
	93 198 317	411476.83D ▲		19301-RAF-003	410226.78D
	93 198 576	411476.83D ▲		19301-RAF-004	410226.78D
	93 198 646	411476.83D ▲		19301-REA-305	410224.78D
	93 275 736	410520.92D ▲		19301-RME-305	410224.78D
	94 372 762	3468.88D		19301-RNA-305	410224.82D
	94 580 182	410183.82D		19301-RNA-306	410224.82D
	96 610 574	410183.88D		19301-RNA-307	410224.82D
	97 087 130	3467.85D		19301-RP3-305	410224.78D
	97 094 283	3004.82			
			<b>HYUNDAI</b>		
<b>HAKO</b>	69015347	4264.87D		25500-22600	410351.88D
				25500-23001	410348.82D
<b>HOLDEN</b>	92 063 300	4177.92D		25511-29000	4446.83D

# Vergleichsliste | Cross References

Hersteller Manufacturer Réf. Constructeur	Hersteller-Nr. Manufacturer's Ref. Réf. Constructeurs	Wahler-Nr Wahler-ref. Réf. Wahler	Hersteller Manufacturer Réf. Constructeur	Hersteller-Nr. Manufacturer's Ref. Réf. Constructeurs	Wahler-Nr Wahler-ref. Réf. Wahler	
INNOCENTI	34 402 115	3004.82		9843 2310	4166.79D	
	65 540 40601	3044.80		9843 3497	4165.79D	
INTER. HARV. IHC	3059 676 R 1	4017.82		9846 3637	4174.79D	
	3059 676 R 91	4017.82		9846 7516	4166.79D	
	3059 676 R 92	4017.82		9846 7517	4163.79D	
	3228 046 R 2	4017.82		9849 2868	4163.74D	
	3228 046 R1	4017.82		9849 2873	4163.74D	
	84247900	6010.75D		9849 8322	4622.82D0	
				9849 8322 Kit	410763.82D	
ISUZU	5-86000-349-0	410224.78D		9943 1512	4619.86	
	5-86000-350-0	410224.78D		JAGUAR	C28067	4006.82D
	5-86008138	410224.82D			C33012	4006.82D
	5-86012-056	410224.78D		JEEP	C37129	4006.82D
	5-86014-381-0	410224.78D			04494469	3000.90
	5-86018-963	410224.78D			5175583AB	4630.87D ▲
	5-86018-964-0	410224.78D			52028185AB	3000.90
	5-86019-507-0	410224.78D			T 069 7157	4147.80D
	5-86019-513-0	410224.78D		JOHN DEERE		
	8-79312-726-0	3467.85D			AT 22961	3000.83
	8-94123-295-0	3468.88D			AT 22963	3000.90
	8-94123-295-1	3468.88D			RE 33705	3000.90
	8-94360-227-0	3467.85D		KIA		
	8-94372-762-0	3468.88D			OK2A-15-171	410352.82D
	8-97087-130-2	3467.85D			OK2C0-15-171A	410352.88D
	94 207 217	3004.82			OK710-15-171	3498.88D
	94 214 962	4022.82D			OK9FC-15-171	3498.88D
IVECO	413 8769	3000.83		KE5D3-15-171	3498.88D	
	468 4390	4008.79D		KHE41-15-171	410352.82D	
	470 3088	4008.79D		KOMATSU	2871 591 M	4520.80D
	471 6264	4152.79D			2872 578 M	4530.80
	473 8169	4165.79D		LADA		
	474 9724	4105.75D			21080-13060-10	3333.87
	477 0246	4174.79D			2108-13060-10	3333.87
	480 4321	4166.79D			21081-3060-11	3333.87
	480 7492	4152.79D			21215-13060-15	4446.83D
	482 3211	4174.79D		LANCIA		
	483 1783	4152.79D			4652 0785	410513.88D
	483 7166	4174.79D			4652 2664	3163.88D
	50 032 9622	4174.82D			4654 6375	410512.88D
	50 401 7209	3171.82D			4679 0294	410511.88D
	50 404 5799	3169.79D			599 9818	3431.80D
	50 408 4365	3169.79D			754 0318	4022.82D1
	50 409 6443	4619.86			758 1201	3109.82D
	50 409 6443 Kit	410608.86D			758 1636	3109.82D
	50 413 2246	410075.79D ▲			758 9135	3105.87D
	50 415 0562	410081.79D		779 4218	410513.88D	
	50 425 8346	410289.81D		7910247116	4122.87D	
	50 432 0545	410289.81D		8234 2688	3356.80D	
	50 438 7382	410937.82D ▲		9616 0901 80	4446.83D	
6131 6592	4162.79D	LANDROVER				
6131 8373	4162.79D		GTS 303	4147.80D		
730 3615	4151.79D		RTC 6673	4158.80D		
809 6735	4174.79D					
9842 0718	4163.79D	LEXUS	90916-03079	411545.82D ▲		
9842 4854	4165.79D		90916-03081	411545.82D ▲		

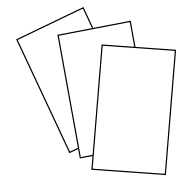

Hersteller Manufacturer Réf. Constructeur	Hersteller-Nr. Manufacturer's Ref. Réf. Constructeurs	Wahler-Nr Wahler-ref. Réf. Wahler	Hersteller Manufacturer Réf. Constructeur	Hersteller-Nr. Manufacturer's Ref. Réf. Constructeurs	Wahler-Nr Wahler-ref. Réf. Wahler	
LIEBHERR	90916-03144	4480.82D		8173-99-152 A	3499.88D	
	90916-03145	4480.82D		8173-99-152 B	3119.88D3	
				8173-99-152 B	3499.88D	
	738 0513	4530.80		8AB1-15-171	3498.88D	
	738 0833	4083.79 ▲		8AB3 15 171	4006.82D	
LOMBARDINI				8AB5-15-171	3498.88D	
	1000208309	4007.80D		8AB7-15-171	3499.82D	
	104 9195 092	4008.79D		8AB8-15-171	3498.88D	
	9195 057	4007.80D		8AB9-15-171	3499.82D	
	9195 1240	4007.80D		8ABA-15-171	3499.88D	
	ED0091951240S	4007.80D		8ABB-15-171	3499.88D	
MACK				8ABB-15-171A	3499.88D	
	657 GC 324 A-P80	411045.82D		8ABC-15-171	3499.82D	
MAN				8ABD-15-171	3499.88D	
	51.06402.0034	4150.79D50		8ABE-15-171	3498.88D	
	51.06402.0042	4150.71D50		8AG1-15-171	3468.88D	
	51.06402.0043	4150.79D50		8AG1-15-171A	3468.88D	
	51.06402.0044	4150.79D50		8AG2-15-171	3468.88D	
	51.06402.0049	4150.79D50		8AG2-15-171A	3468.88D	
	51.06402.0050	4150.79D50		8AG3-15-171	3498.88D	
	51.06402.0051	4150.79D50		8AG4-15-171	3119.88D3	
	51.06402.0052	4150.71D50		8AG4-15-171	3499.88D	
	51.06402.0053	4150.79D50		8AG5-15-171	3498.88D	
	51.06402.0056	4150.79D50		8AG6-15-171	3468.88D	
	51.06402.0057	4150.71D50		8AG7-15-171	3468.88D	
	51.06402.0058	4150.83D50		8AG8-15-171	3468.88D	
	51.06402.0060	4150.83D50		8AGX-15-171	4639.82D	
	51.06402.0061	4150.79D50		8AK1-15-171	3498.88D	
	51.06402.0062	4150.71D50		8AN1-15-171	3498.88D	
	51.06402.0063	4150.83D50		8AU1-15-171	3498.88D	
	51.06402.0064	4150.79D50		8AU-15-171	3498.88D	
	51.06402.0065	4150.71D50		8AX1-15-171	3119.88D3	
	51.06402.0066	4150.83D50		8AX1-15-171	3499.88D	
	51.06402.0067	4150.79D50		8AZ1-15-171	3468.88D	
	51.06402.0068	4150.71D50		AB6-15-171	3498.88D	
	51.06402.0069	4150.79D50		B366-15-171	3499.82D	
	81.06401.0019	410864.71D0		B3H3-15-171	3499.82D	
	81.06401.0037	410864.79D0		B3H8-15-171A	3499.82D	
	81.06401.0038	410864.83D0		B541-15-171	3119.88D3	
	81.06401.0042	410864.71D0		B541-15-171	3499.88D	
	81.06401.0045	410864.83D0		B6H-15-171	3498.88D	
	81.06401.0046	410864.79D0		B6H-15-171 A	3498.88D	
	81.06401.6002	4373.70 ▲		BP6F-15-171	3498.88D	
MAZDA				BPD3-15-171	3498.88D	
	0223-15-171	3499.82D		E5D3-15-171	3498.88D	
	0419-15-171	3499.82D		F201-15-171	3498.88D	
	0419-99-152	3499.82D		FS05-15-171	4639.82D	
	1A51-15-171	4639.82D		HE 41-99-152 A	3119.88D3	
	1E03-15-171	3004.92D1		HE 41-99-152 C	3119.82D3	
	1E05-15-171 A	4457.82D		HE 41-99-152C	3499.82D	
	1E07-15-171	410131.88D		HE 41-99-152D	3499.82D	
	1E07-15-171 A	410131.88D		KL01-15-171	4639.82D	
	8124-99-152	3119.82		KL01-15-171 A	4639.82D	
	8173-15-152 C	3499.88D		RF03-15-171A	3468.88D	
	8173-15-171	3499.88D		ZZ40-15-171	3498.88D	
	8173-99-152	3499.88D				
	8173-99-152 A	3119.88D3				
				<b>MERCEDES-BENZ</b>		
					000 203 64 75	3000.80

# Vergleichsliste | Cross References

Hersteller Manufacturer Réf. Constructeur	Hersteller-Nr. Manufacturer's Ref. Réf. Constructeurs	Wahler-Nr Wahler-ref. Réf. Wahler	Hersteller Manufacturer Réf. Constructeur	Hersteller-Nr. Manufacturer's Ref. Réf. Constructeurs	Wahler-Nr Wahler-ref. Réf. Wahler
MERCEDES-BENZ	001 203 58 75	3000.80		005 203 59 75	4472.83D
	001 203 69 75	4083.83D50		100 200 05 15	4078.87D
	001 203 90 75	4078.79D		100 200 07 15	4078.79D
	001 203 91 75	4078.87D		102 200 08 15	4078.87D
	002 203 04 75	4083.83D50		102 200 14 15	4078.87D
	002 203 16 75	4078.71D		102 200 15 15	4078.87D
	002 203 31 75	4078.71D		102 200 19 15	4078.87D
	002 203 32 75	4105.83D		110 200 01 11	4078.87D
	002 203 35 75	4078.79D		110 200 05 15	4078.87D
	002 203 37 75	4078.79D		110 200 09 15	4078.71D
	002 203 38 75	4078.79D		110 200 19 15	4078.92D
	002 203 39 75	4105.71D		111 200 03 15	4276.87D
	002 203 45 75	4105.83D		111 200 08 15	4279.87D
	002 203 46 75	4078.79D		111 200 09 15	4275.87D
	002 203 47 75	4105.83D		111 200 17 15	4414.87D
	002 203 49 75	4105.83D		111 203 02 75	4275.87D
	002 203 53 75	4083.83D50		111 203 03 75	4276.87D
	002 203 56 75	4105.83D		111 203 05 75	4279.87D
	002 203 59 75	4105.83D		111 203 06 75	4275.87D
	002 203 72 75	4078.79D		111 203 08 75	4275.87D
	002 203 75 75	4117.80D		111 203 10 75	4414.87D
	002 203 76 75	4078.87D		112 200 00 15	4281.87D
	002 203 78 75	4078.79D		112 200 01 15	4298.87D
	002 203 79 75	4105.83D		112 203 02 75	4281.87D
	002 203 80 75	4117.80D		112 203 03 75	4298.87D
	002 203 81 75	4078.87D		116 200 00 15	4064.75D
	002 203 82 75	4064.75D		116 200 02 15	4233.84D
	002 203 90 75	4105.83D		116 200 03 15	4137.80D
	003 203 14 75	4105.83D		119 200 00 15	4278.80D
	003 203 22 75	3000.80		119 203 01 75	4278.80D
	003 203 28 75	4105.83D		120 200 00 15	4517.87D
	003 203 29 75	4105.71D		120 203 02 75	4517.87D
	003 203 31 75	4105.83D		160 200 03 15	3142.90D
	003 203 32 75	4105.71D		166 203 00 75	411576.87D ▲
	003 203 73 75	4105.83D		166 203 01 75	411576.87D ▲
	003 203 74 75	4105.71D		166 203 02 75	411576.87D ▲
	003 203 78 75	4105.83D		266 203 02 75	411577.80D ▲
	003 203 79 75	4105.71D		266 203 04 75	411577.80D ▲
	003 203 82 75	4233.84D		266 203 06 75	411577.80D ▲
	003 203 91 75	4105.79D		271 200 00 15	3457.90D
	003 203 92 75	4105.79D		271 200 01 15	410389.103D ▲
	003 203 98 75	4176.80D		271 200 02 15	410389.103D ▲
	004 203 09 75	4176.85D		271 200 03 15	410389.103D ▲
	004 203 39 75	4137.80D		271 203 03 75	3457.90D
	004 203 40 75	4137.80D		272 200 00 15	4834.100D
	004 203 65 75	4078.65D		272 200 01 15	4834.100D
	004 203 83 75	4105.83D		272 200 04 15	4834.100D
	004 203 84 75	4105.71D		272 200 05 15	4833.100D
	004 203 85 75	4105.79D		272 200 06 15	4829.100D ▲
	004 203 86 75	4078.92D		273 200 01 15	4829.100D ▲
005 203 17 75	4619.75		273 200 02 15	4833.100D	
005 203 18 75	4619.80		273 200 04 15	4829.100D ▲	
005 203 19 75	4619.86		373 203 70 75	4105.83D	
005 203 26 75	4105.83D		601 200 00 15	4176.85D	
005 203 27 75	4105.79D		601 200 01 15	4176.80D	
005 203 28 75	4105.71D		602 200 00 15	4176.80D	
005 203 29 75	4123.80D		603 200 00 15	4176.80D	

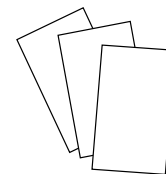

Hersteller Manufacturer Réf. Constructeur	Hersteller-Nr. Manufacturer's Ref. Réf. Constructeurs	Wahler-Nr Wahler-ref. Réf. Wahler	Hersteller Manufacturer Réf. Constructeur	Hersteller-Nr. Manufacturer's Ref. Réf. Constructeurs	Wahler-Nr Wahler-ref. Réf. Wahler
	603 203 04 74	4280.80D		MD 345617	4637.76D
	603 203 04 74	4280.85D		MD 348937	410180.82D
	604 203 00 75	4280.85D		MD 351495	410180.82D
	605 203 00 75	4280.80D		MD 360320	4637.82D
	606 203 01 75	4176.80D		MD 972903	3119.88D4
	606 203 02 75	4176.85D		MD 972905	3119.82D4
	606 203 05 75	4176.85D		MD 972908	3119.82D4
	607 200 00 15	3004.82		MD 997217	3119.82D4
	611 200 02 15	410171.87D		MD 997219	3119.82D4
	611 200 07 15	410171.87D		MD 997220	3119.82D4
	611 203 04 75	410171.87D		MD 997221	3119.88
	611 203 05 75	410171.87D		MD 997221	3119.88D4
	611 203 15 75	410171.87D		MD 997224	4638.82D
	611 203 19 75	410171.87D		MD 997461	3119.88D4
	615 200 13 15	4117.80D		MD 997602	3119.82D4
	616 200 04 15	4117.80D		MD 997603	3119.82D4
	617 200 03 15	4049.80D		MD 997605	4638.76D
	617 200 11 15	4049.80D		MD 997606	4638.82D
	617 200 18 15	4049.80D1		MD 997607	3119.82D4
	628 203 01 75	4309.92D		MD 997608	3119.88D4
	642 200 02 15	4490.87D		MD 997644	410180.82D
	642 200 02 15	4835.87D		ME 190303	4637.76D
	642 200 03 15	4630.87D ▲		ME 191593	4637.76D
	642 200 04 15	4835.87D		ME 200262	4637.76D
	642 200 07 15	4832.87D ▲		ME 220538	410180.82D
	642 200 08 15	410055.87D ▲		ME 241816	410180.82D
	642 200 20 15	4490.87D		ME 999295	4638.82D
	646 200 00 15	410174.92D		MN 980137	3472.87D
	646 200 11 15	410174.92D			
	646 200 12 15	410171.87D	<b>MULTICAR</b>	0820117806	4176.85D
	646 203 02 75	410174.92D		4008540	4264.87D
	660 200 03 15	3146.90D			
			<b>MWM</b>	1215 2752	2391.75
				1215 2766	2391.75
<b>mitsubishi</b>	M-474877	3470.89D50		6 052 5 010 005 0	4520.75
	M-863985	3470.89D50		6 052 5 011 001 1	2391.75
	MD 001370	3119.82D4		6 052 5 011 002 4	2393.75
	MD 005131	3119.88D4		6 052 5 011 004 2	2391.75
	MD 005371	3119.82D4		6 052 5 100 41	2393.75
	MD 008086	3119.82D4		9 225 0 757 014 6	4351.79
	MD 015299	4638.82D		9 229 8 757 004 6	4588.75/1
	MD 075460	3119.82D4		9 407 0 757 002 4	3145.79D
	MD 094120	4638.82D			
	MD 117759	3119.82D4	<b>NEOPLAN</b>	0303.191.04	4520.80D
	MD 126168	3119.82D4			
	MD 158570	4637.82D	<b>NISSAN</b>	11060-00Q0C	411475.89D ▲
	MD 164541	4637.76D		11060-00Q0E	411475.89D ▲
	MD 165630	4637.82D		11060-00Q0K	411442.83D ▲
	MD 170031	4637.76D		11060-00Q0S	411442.83D ▲
	MD 174233	410180.82D		11060-00QAF	410538.89D
	MD 175746	4637.82D		11060-00QAJ	411040.83D
	MD 194988	410180.82D		11060-00QAL	411475.89D ▲
	MD 310106	4637.82D		11060-AW300	410517.89D
	MD 315301	4637.82D		11060-BN700	411043.89D
	MD 317015	4637.76D		11061-00Q0A	411476.83D ▲
	MD 335170	4637.82D		11061-00Q0B	411476.83D ▲
	MD 337408	4637.82D		11061-00Q0D	411039.83D
	MD 338234	4637.82D			

# Vergleichsliste | Cross References

Hersteller Manufacturer Réf. Constructeur	Hersteller-Nr. Manufacturer's Ref. Réf. Constructeurs	Wahler-Nr Wahler-ref. Réf. Wahler	Hersteller Manufacturer Réf. Constructeur	Hersteller-Nr. Manufacturer's Ref. Réf. Constructeurs	Wahler-Nr Wahler-ref. Réf. Wahler
NISSAN	11061-00Q0E	411043.89D		13 38 003	4242.92D
	11061-00Q0G	411476.83D ▲		13 38 007	411193.82D
	11061-00Q0K	411476.83D ▲		13 38 008	411193.82D
	11061-00Q0L	411476.83D ▲		13 38 009	4201.92D
	11061-00Q1B	411476.83D ▲		13 38 015	4297.92D
	11061-00QAB	410517.83D		13 38 015 old number	3017.92D50
	11061-00QAC	410517.83D		13 38 016	3054.92D50
	11061-00QAD	410517.89D		13 38 017	4433.92D
	11061-00QAE	3166.89D		13 38 018	3054.87D50
	11061-00QAG	411043.89D		13 38 020	410048.88D
	11061-00QAL	411043.89D		13 38 024	4255.82D
	11061-00QAM	411039.83D		13 38 030	3004.82
	21200-01B00	3044.90D1		13 38 033	4255.87D
	21200-2H600	3118.82D1		13 38 034	411193.82D
	21200-2H605	3118.88D1		13 38 038	4255.92D
	21200-41B00	3118.82D1		13 38 039	410049.88D
	21200-4M500	3478.82D		13 38 041	3054.87D50
	21200-57J00	410176.82D0		13 38 042	3021.88D50
	21200-57J05	410176.88D0		13 38 046	4115.92D
	21200-57J15	410176.82D0		13 38 049	4144.92D
	21200-6F900	4821.89D		13 38 050	4164.92D
	21200-6F901	4821.89D		13 38 052	3017.92D2
	21200-77A00	4634.76		13 38 054	4144.92D
	21200-77A05	3478.82D		13 38 056	3468.88D
	21200-77A60	4634.76		13 38 057	4164.92D
	21200-77A61	4634.76		13 38 059	4144.82D
	21200-77A63	4634.76		13 38 060	4168.92D
	21200-77A65	3478.82D		13 38 062	4144.82D
	21200-77A66	3478.82D		13 38 063	4164.92D
	21200-78515	3118.88D1		13 38 067	4175.92D
	21200-85G00	3118.82D1		13 38 068	4177.92D
	21200-85G05	3118.88D1		13 38 069	4180.82D
	21200-85G06	3118.88D1		13 38 073	4178.92D
	21200-86J00	3478.82D		13 38 075	3467.85D
	21200-86J01	3478.82D		13 38 076	4237.80D
	21200-90J00	3478.82D		13 38 077	3004.82
	21200-90J10	3478.82D		13 38 079	4183.92D
	21200-99B03	3118.82D1		13 38 080	4183.82D
	21200-9F600	3478.82D		13 38 084	4175.92D
	21200-BX000	410488.88D		13 38 087	4188.92D
	21200-ED000	411241.82D		13 38 096	4459.92D
	21200-ED00A	411241.82D		13 38 097	4201.92D
	21200-G3100	3000.83		13 38 100	4198.92D
	21200-P7500	3118.88D1		13 38 154	410049.88D
	21200-P7901	3118.82D1		13 38 178	4431.105D
	21200-P7905	3118.88D1		13 38 275	410049.88D
	21200-P7906	3118.88D1		13 38 331	4208.92D
21200-P7990	3118.82D1		13 38 427	411193.82D	
21200-P7991	3118.88D1		13 38 466	4158.80D	
21200-V0100	3118.82D1		13 38 478	4194.92D	
21200-V0105	3118.88D1		13 41 002	6010.95D	
21200-V0200	3118.82D1		13 41 011	6031.100D	
21200-V0201	3118.82D1		13 41 017	6031.105D	
21200-V0205	3118.88D1		13 41 028	6031.88D	
21200-V0206	3118.88D1		1338 001	411578.92D ▲	
			1338 004	411579.92D ▲	
			1338 098	411578.92D ▲	
OPEL	13 38 002	4207.92D			



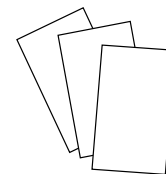

Hersteller Manufacturer Réf. Constructeur	Hersteller-Nr. Manufacturer's Ref. Réf. Constructeurs	Wahler-Nr Wahler-ref. Réf. Wahler	Hersteller Manufacturer Réf. Constructeur	Hersteller-Nr. Manufacturer's Ref. Réf. Constructeurs	Wahler-Nr Wahler-ref. Réf. Wahler
	44 00 106	4151.76D		1338 13	4447.85D
	44 02 719	3470.89D50		1338 19	4447.80D
	44 04 305	410517.89D		1338 20	4147.80D
	44 08 334	3466.89D		1338 21	4821.89D
	44 08 928	410517.83D		1338 23	4446.83D
	44 09 180	126104 ▲		1338 25	4147.80D
	44 32 983	410517.83D		1338 26	4450.89D
	44 33 121	411476.83D ▲		1338 37	3136.82D50
	44 34 144	411476.83D ▲		1338 38	410058.84D
	44 34 190	411476.83D ▲		1338 39	4450.83D
	44 49 134	411476.83D ▲		1338 44	3136.88D50
	44 49 506	411476.83D ▲		1338 71	4447.85D
	45 00 823	4174.79D		1338 72	4447.80D
	47 08 757	410588.88D		1338 83	3136.82D50
	48 11 586	4189.87D		1338 90	4174.82D
	63 38 004	4428.92D		1338 A0	3483.89D
	63 38 018	4431.105D		1338 C8	4821.89D
	63 38 022	410588.88D		1338 F5	3497.88D
	63 38 028	4459.92D		5474546	6010.88D
	63 38 039	410048.88D		79 100 118 73	3053.75
	63 38 050	4357.92D		79 102 461 13	4122.87D
	6338 005	411578.92D ▲		79 102 471 16	4122.87D
	6338 035	411578.92D ▲		91 500 723 80	3061.82
	93 18 4200	410048.88D		91 500 724 80	3061.88
				96 057 087 80	3136.88D50
<b>PACCAR</b>	129 3885 / F75-85-95	411133.80D		96 057 136 80	3136.88D50
	166 1375 / CF 75	411135.87D		96 090 230 80	4147.80D
	168 4900 / CF 75	411135.83D		96 108 092 80	4450.89D
				96 108 093 80	4450.89D
<b>PEGASO</b>	222730	4619.75		96 160 902 80	4450.83D
	770275	4078.75D		96 196 379 80	3136.88D50
	770662	4619.75		96 272 785 80	4447.80D
				96 272 814 80	4447.85D
<b>PERKINS</b>	7483490	3000.75		96 300 666 80	3483.89D
	PF 52.842	3000.80		96 300 667 80	3463.89D
				96 472 659 80	410705.89D
<b>PEUGEOT</b>	1264 32	6031.92D		96 485 426 80	410184.89D
	1264 33	6035.92D			
	1264 50	6031.88D	<b>PORSCHE</b>	928.106.129.06	4161.83
	1264 50	6031.92D		928.106.129.16	4161.83
	1336 A7	3431.80D		928.106.129.17	4161.83
	1336 AA	410075.79D ▲		944.106.019.00	4256.83D60
	1336 N5	3463.89D		944.106.129.05	4256.80D60
	1336 Q1	3463.89D		944.106.129.05	4256.83D60
	1336 Q2	410184.89D		944.606.481.00	6010.92D
	1336 Z0	410705.89D		955.106.113.00	4455.80D
	1337 26	3053.75		996.106.013.54	4249.83D
	1337 27	3136.88D50		996.106.013.55	4249.83D
	1337 30	3136.82D50		996.106.013.56	4249.83D
	1337 34	4122.87D		996.106.013.57	4249.83D
	1337 47	3061.82		996.106.121.53	4249.83D
	1337 48	3159.82D		996.106.125.52	4249.83D
	1337 49	3061.88			
	1337 64	4147.80D	<b>RENAULT</b>	00 24 774 033	4529.70
	1337 65	3033.84D ▲		11 06 023 09R	411477.89D ▲
	1337 68	4147.80D		11 06 030 26R	411442.83D ▲
	1338 11	3136.88D50		11 06 055 36R	411442.83D ▲

# Vergleichsliste | Cross References

Hersteller Manufacturer Réf. Constructeur	Hersteller-Nr. Manufacturer's Ref. Réf. Constructeurs	Wahler-Nr Wahler-ref. Réf. Wahler	Hersteller Manufacturer Réf. Constructeur	Hersteller-Nr. Manufacturer's Ref. Réf. Constructeurs	Wahler-Nr Wahler-ref. Réf. Wahler
RENAULT	50 00 684 865	410828.82D0		77 01 348 373	3470.89D50
	50 00 684 865 Kit	410828.82D		77 01 348 374	3029.86
	50 00 691 267	410828.86D0		77 01 348 376	3029.83
	50 00 691 267 Kit	410828.86D		77 01 349 173	4122.87D
	50 00 694 785	4529.83D0		77 01 349 415	4122.87D
	50 00 816 924	4151.76D		77 01 474 248	410518.89D
	50 01 855 520	4619.82		77 01 474 249	410530.89D
	50 10 284 184	411045.82D		82 00 039 885	411043.89D
	50 10 295 225	4596.83D		82 00 074 346	410517.89D
	50 10 295 225 2x Kit	410758.83D		82 00 074 349	410517.83D
	50 10 447 161	4619.86		82 00 112 054	410538.89D
	50 10 553 100	4619.86		82 00 171 021	411043.89D
	60 01 543 366	3466.89D		82 00 244 023	411039.83D
	60 05 000 004	2391.75		82 00 244 402	411043.89D
	60 05 004 616	2391.75		82 00 248 531	411477.89D ▲
	60 05 004 616	2393.75		82 00 267 349	411042.89D
	74 31 397 947	4272.90D		82 00 374 994	411043.89D
	74 36 842 409	4272.90D		82 00 380 898	411475.89D ▲
	74 39 180 811	4272.90D		82 00 400 553	411040.83D
	77 00 024 756	2389.75/1		82 00 400 554	411039.83D
	77 00 024 756	2391.75		82 00 403 437	411476.83D ▲
	77 00 101 179	126104 ▲		82 00 558 751	411040.83D
	77 00 109 641	410530.89D		82 00 558 758	411039.83D
	77 00 110 716	3166.89D		82 00 558 766	411042.89D
	77 00 112 491	410518.89D		82 00 558 779	411477.89D ▲
	77 00 260 959	4449.84D		82 00 558 783	411043.89D
	77 00 575 874	3029.83		82 00 561 420	126104 ▲
	77 00 619 931	3029.86		82 00 656 419	411475.89D ▲
	77 00 657 955	4122.87D		82 00 656 420	411475.89D ▲
	77 00 665 226	4147.80D		82 00 660 882	3166.89D
	77 00 697 157	4147.80D		82 00 674 368	410517.89D
	77 00 703 136	4122.87D		82 00 674 369	410517.83D
	77 00 710 657	4122.87D		82 00 699 392	411475.89D ▲
	77 00 722 762	3029.86		82 00 703 139	411475.89D ▲
	77 00 723 945	3470.89D50		82 00 703 140	411476.83D ▲
	77 00 727 190	3029.89		82 00 772 985	3466.89D
	77 00 730 540	3029.89		82 00 801 567	411476.83D ▲
	77 00 742 617	3469.91D		82 00 801 570	411475.89D ▲
	77 00 858 087	4147.80D		82 00 801 571	411475.89D ▲
	77 00 858 802	3469.91D		82 00 907 229	411475.89D ▲
	77 00 862 200	4147.80D		82 00 907 234	411475.89D ▲
	77 00 866 387	126104 ▲		82 00 907 239	411476.83D ▲
	77 00 866 896	3470.89D50		82 00 907 243	411476.83D ▲
	77 00 868 274	4446.83D		82 00 954 285	411043.89D
	77 00 868 980	3174.89D		82 00 954 288	411039.83D
	77 00 872 314	3470.89D50		82 00 954 289	411481.89D ▲
	77 00 872 554	3466.89D		82 00 954 328	411442.83D ▲
77 00 872 635	3466.89D				
77 01 026 647	4008.79D		ROLLS-ROYCE	11 53 7 586 885	4508.105D
77 01 035 736	3116.82D				
77 01 038 494	4446.83D		ROVER	GTS 282	3000.83
77 01 039 156	3116.82D			GTS 287	4158.80D
77 01 042 512	4174.79D			GTS 298	3000.90
77 01 068 770	411241.82D			GTS 299	4821.89D
77 01 348 068	3029.89			GTS 301	410808.88D
77 01 348 139	3053.85			PEL 000170	410806.88D
77 01 348 372	3136.82D50			PEL 10009 EVA	4158.80D

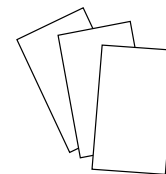

Hersteller Manufacturer Réf. Constructeur	Hersteller-Nr. Manufacturer's Ref. Réf. Constructeurs	Wahler-Nr Wahler-ref. Réf. Wahler	Hersteller Manufacturer Réf. Constructeur	Hersteller-Nr. Manufacturer's Ref. Réf. Constructeurs	Wahler-Nr Wahler-ref. Réf. Wahler	
SAAB	PEL 10016	410808.88D		032 121 110 L	410475.87D	
	PEL 10019 EVA	4821.89D		032 121 110 P	3143.87D	
				032 121 121 G	410475.87D	
	12 61 5097	411193.82D		032 121 121 K	410475.87D	
	12 62 2410	411193.82D		03G 121 111 A	4820.87D	
	24 435 102	4357.92D		03G 121 113	3472.87D	
	30 57 7561	4154.88D		03G 121 113 A	4820.87D	
	45 03 017	4175.92D		03L 121 111 AE	410845.87D	
	46 23 815	4175.92D		03L 121 111 R	410845.92D	
	47 72 190	4193.92D		03L 121 111 S	410845.92D	
	55 20 3388	410049.88D		03L 121 113 B	410537.92D	
	640972	411578.92D ▲		03L 121 114 B	410536.92D	
	75 02 297	4022.82D		044 121 113	4264.87D	
	75 17 345	4154.82D		050 121 113 C	3141.87D	
	83 89 512	4022.88D		056 121 113 D	4264.87D	
	85 47 572	6010.88D		068 121 113 H	4253.87D	
	85 69 23	6010.92D		06D 121 111 G	411186.87D	
	88 17 298	4154.88D		06F 121 111 F	411187.87D	
	88 17 538	4154.82D		075 121 113 D	4123.80D	
	88 22 025	4154.88D		191 959 481 A	6017.95D	
	90 53 7453	411193.82D		191 959 481 B	6020.95D	
	90 53 7811	411193.82D		191 959 481 C	6017.95D	
	91 66 687	4154.88D		1H0 959 481	6037.95D	
	91 94 101	4154.88D		1H0 959 481 B	6037.95D	
	91 94 242	4154.88D		251 959 481	6017.95D	
	93 20 284	4022.92D		321 959 481 A	6017.95D	
	93 37 551	4022.82D		321 959 481 C	6017.95D	
	95 26 518	6010.95D		321 959 481 D	6017.95D	
	SAURER	154.0943.426		4530.80	6U0 959 481 A	6017.95D
		461.0943		4030.70	823 959 481	6010.92D
			823 959 481 A	6010.92D		
SCANIA	1 347 594	4224.80D	823 959 481 F	6010.92D		
	1 358 995	4223.83D	823 959 481 G	6010.95D		
	1 395 856	4520.75	823 959 481 L	6010.92D		
	1 404 924	4223.83D	867 959 481	6039.95D		
	1 404 925	4224.80D	CA 032.221.01	3000.83		
	1 423 450	4223.83D	EA03222101	3023.87D		
	1 423 451	411004.80D	SE 020 032 221 A	3361.87D		
	1 431 979	4223.75D	SE 021 032 221 B	4256.87D50		
	1 458 198	4224.75D	SE 021 952 600 A	6020.92D		
	1 745 449	4224.80D				
	1 799 757	411004.80D	SKODA	032 121 110 B	3143.87D	
	1 800 909	411004.80D		032 121 110 B	410989.87D	
	1 849 060	411004.80D		032 121 110 F	3167.83D	
	2 832 814	4520.80D		032 121 110 J	410989.87D	
	238 156	3096.75		032 121 110 L	410475.87D	
	283 281	4520.80D		032 121 110 P	3143.87D	
	525 076	3096.75		032 121 113	4253.87D	
	550 275	4520.80D		032 121 121 G	410475.87D	
				032 121 121 K	410475.87D	
	SEAT	0004218650		3345.79	03G 121 111 A	4820.87D
030 121 113 B		4264.84D		03G 121 113	3472.87D	
032 121 110 B		3143.87D		03G 121 113 A	4820.87D	
032 121 110 B		410989.87D		03L 121 111 AE	410845.87D	
032 121 110 F		3167.83D		03L 121 111 R	410845.92D	
032 121 110 J		410989.87D		03L 121 111 S	410845.92D	
				03L 121 113 B	410537.92D	

# Vergleichsliste | Cross References

Hersteller Manufacturer Réf. Constructeur	Hersteller-Nr. Manufacturer's Ref. Réf. Constructeurs	Wahler-Nr Wahler-ref. Réf. Wahler	Hersteller Manufacturer Réf. Constructeur	Hersteller-Nr. Manufacturer's Ref. Réf. Constructeurs	Wahler-Nr Wahler-ref. Réf. Wahler
SKODA	03L 121 114 B	410536.92D	SUZUKI	21210-AA120	411716.88D ▲
	044 121 113	4264.87D		21210-AA140	411715.84D ▲
	050 121 113 C	3141.87D		21210-AA150	411716.88D ▲
	056 121 113	4253.87D		21210-AA160	411715.84D ▲
	056 121 113 D	4264.87D		31753-0100	3000.83
	068 121 113 H	4253.87D			
	06D 121 111 G	411186.87D		17570-74000	410228.82D
	06F 121 111 F	411187.87D		17570-740001	410228.82D
	077 121 113	4274.87D		17570-86CA0	4446.83D
	077 121 113 B	4274.87D		17600-77820	410183.88D
	078 121 113	4274.87D		17600-83810	410228.82D
	078 121 113 C	4274.87D		17600-83811	410228.82D
	078 121 113 F	4274.87D		17600-83820	410228.82D
	078 121 113 J	4274.87D		17600-83821	410228.82D
	113 095 0	3032.80		17600-83821-000	3119.82
	113 095 075	6010.75D		17600-83822	410228.82D
	113 095 090	6010.92D		17600-83823	410228.82D
	113 095 091	3032.80		17600-85811	410183.82D
	114 095 090	3032.88		17600-85821	410183.88D
	115 095 070	6010.88D		17600-85830	410228.82D
	1H0 959 481 B	6037.95D		17600-85831	410228.82D
441 044 330 186	6017.95D	17670-50G00	410183.82D		
823 959 481 G	6010.95D	17670-50G10	410183.88D		
823 959 481 H	6010.95D	17670-50G20	410183.88D		
823 959 481 K	6010.95D	17670-63J00	410229.82D		
867 959 481	6039.95D	17670-65D00	410229.82D		
		17670-66G00	4446.83D		
SMART	0003179V009	3142.90D	17670-67H00	410183.88D	
	0003179V010	3142.90D	17670-73000	410228.82D	
	0004698V002	3146.90D	17670-73020	410228.82D	
	0004698V003	3146.90D	17670-73021	410228.82D	
	660 200 05 15	3146.90D	17670-76A00	410183.82D	
	Q0003179V010000000	3142.90D	17670-76A01	410183.82D	
			17670-76G00	410183.82D	
STEYR	217.87.71	6010.75D	17670-76G10	410183.88D	
	311.00.06.0065	4368.87	17670-77E00	410229.82D	
	609E060013	4520.80D	17670-77E10	4639.82D	
		17670-77E11	4639.82D		
SUBARU	21200-AA071	410230.78D	17670-77G00	410183.82D	
	21200-AA072	410230.78D	17670-77G10	410183.88D	
	21200-AA140	411715.84D ▲	17670-78E00	3468.88D	
	21200-AA150	411716.88D ▲	17670-82810-000	410183.82D	
	21200-AA160	411715.84D ▲	17670-83000	410228.82D	
	21200-AA170	411743.82D ▲	17670-83001	410228.82D	
	21200-AA200	411716.88D ▲	17670-83010	410228.82D	
	21200-AA220	411715.84D ▲	17670-83011	410228.82D	
	21200-AA230	411715.84D ▲	17670-85020	410183.88D	
	21200-KA010	410183.82D	17670-85C00	410229.82D	
	21200-KA050	410183.82D	17690 84A00	411043.89D	
	21200-KA070	410183.88D	17690-67JG0	410538.89D	
	21200-KA150	410183.82D	17690-79J50	410049.88D	
	21200-KA151	410183.82D	17690-84A10	411043.89D	
	21200-KA152	410183.82D	17690-84A11	411043.89D	
	21200-KA153	410183.82D	17690-84A50-000	411039.83D	
	21200-KA154	410183.82D	17690-84A51	411477.89D ▲	
	21210-AA030	410230.78D	17690-84E50-000	410588.88D	
	21210-AA080	411743.82D ▲			

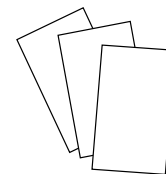

Hersteller Manufacturer Réf. Constructeur	Hersteller-Nr. Manufacturer's Ref. Réf. Constructeurs	Wahler-Nr Wahler-ref. Réf. Wahler	Hersteller Manufacturer Réf. Constructeur	Hersteller-Nr. Manufacturer's Ref. Réf. Constructeurs	Wahler-Nr Wahler-ref. Réf. Wahler
TALBOT	131 666.00	4026.89		13 38 018	3054.87D50
				13 38 024	4255.82D
TOYOTA	16340-54010	3477.88D		13 38 033	4255.87D
	90080-23002	3478.82D		13 38 038	4255.92D
	90916-03040	3119.88		13 38 041	3054.87D50
	90916-03040	3119.88D5		13 38 042	3021.88D50
	90916-03043	3477.88D		13 38 046	4115.92D
	90916-03043	4126.88		13 38 049	4144.92D
	90916-03046	4103.82D		13 38 052	3017.92D2
	90916-03055	3119.82D5		13 38 057	4164.92D
	90916-03060	3478.82D		13 38 060	4168.92D
	90916-03062	3477.88D		13 38 063	4164.92D
	90916-03062	4126.88		13 38 067	4175.92D
	90916-03065	4103.82D		13 38 068	4177.92D
	90916-03069	4103.82D		13 38 069	4180.82D
	90916-03072	3477.88D		13 38 073	4178.92D
	90916-03075	4480.82D		13 38 076	4237.80D
	90916-03078	3119.88D5		13 38 079	4183.92D
	90916-03079	411545.82D ▲		13 38 084	4175.92D
	90916-03081	411545.82D ▲		13 38 096	4459.92D
	90916-03084	4480.82D		13 38 466	4158.80D
	90916-03088	410178.82D		13 41 002	6010.95D
	90916-03090	3478.82D		13 41 011	6031.100D
	90916-03093	410231.82D		13 41 017	6031.105D
	90916-03095	3478.82D		13 41 028	6031.88D
	90916-03096	3478.82D		21 018 811	411193.82D
	90916-03097	410181.82D		24 405 922	4431.105D
	90916-03099	3477.88D		24 420 728	4297.92D
	90916-03101	410178.82D		24 435 781	4201.92D
	90916-03106	3477.88D		24 447 862	4433.92D
	90916-03109	3478.82D		24 456 401	411578.92D ▲
	90916-03115	3478.82D		40 191 1858	3021.88
	90916-03118	410181.82D		55 182 499	410588.88D
	90916-03120	410178.82D		55 202 510	410049.88D
90916-03122	410201.80D		55 577 072	4431.105D	
90916-03123	410231.82D		9 108 106	4151.76D	
90916-03125	4480.82D		9 110 719	3470.89D50	
90916-03129	4480.82D		90 009 956	4115.92D	
90916-03133	4480.82D		90 067 918	4255.92D	
90916-03136	4480.82D		90 108 636	6010.95D	
90916-03140	4480.82D		90 242 277	6031.100D	
90916-03144	4480.82D		90 264 080	4144.92D	
90916-03145	4480.82D		90 277 288	6031.105D	
90916-54010	3477.88D		90 357 303	6031.88D	
90916-A3001	4480.82D		90 411 948	4177.92D	
90916-A3002	4480.82D		90 509 110	4237.80D	
90916-A3003	4480.82D		90 529 846	4188.92D	
SU001-0223	4446.83D		90 536 262	411578.92D ▲	
			90 536 501	411578.92D ▲	
VALTRA	114 470	4351.79		90 537 453	411193.82D
	149 620	4588.75/1		90 537 605	411193.82D
				90 537 811	411193.82D
VAUXHALL	02 898 440	3054.92D50		90 570 620	4459.92D
	08 966 485	4255.87D		90 572 899	4198.92D
	12 615 097	411193.82D		90 573 326	4208.92D
	12 622 410	411193.82D		90 573 926	4201.92D
	13 38 016	3054.92D50		91 153 670	4158.80D

# Vergleichsliste | Cross References

Hersteller Manufacturer Réf. Constructeur	Hersteller-Nr. Manufacturer's Ref. Réf. Constructeurs	Wahler-Nr Wahler-ref. Réf. Wahler	Hersteller Manufacturer Réf. Constructeur	Hersteller-Nr. Manufacturer's Ref. Réf. Constructeurs	Wahler-Nr Wahler-ref. Réf. Wahler
VAUXHALL	91 159 950	3466.89D		059 121 113 A	4006.82D
	91 160 216	126104 ▲		059 121 113 B	4006.82D
	91 28 786	4207.92D		062 121 111 A	3145.79D
	91 29 907	4242.92D		062 121 111 B	3145.79D
	91 61 123	4174.79D		068 121 113 A	4256.71
	93 177 343	410588.88D		068 121 113 H	4253.87D
	93 179 136	410049.88D		069 121 113	4116.87D1
	93 181 245	411578.92D ▲		069 121 113 A	4116.87D1
	93 198 035	411476.83D ▲		06B 121 113 A	3141.87D
	93 198 289	411476.83D ▲		06C 121 111 C	4814.92D
	93 198 317	411476.83D ▲		06C 121 111 D	4814.92D
	93 198 576	411476.83D ▲		06C 121 111 E	4814.92D
	93 198 646	411476.83D ▲		06D 121 111 G	411186.87D
	94 372 762	3468.88D		06F 121 111 F	411187.87D
	97 087 130	3467.85D		070 121 114	4430.87D
			075 121 113 D	4123.80D	
VM	3 901 2004 F	4158.80D		076 121 113 A	4123.70
	4 901 2012 F	4030.70		077 121 113	4274.87D
VOLKSWAGEN				077 121 113 B	4274.87D
	00A 121 113	4275.87D		077 121 113 C	4274.82D
	022 121 113	4455.80D		078 121 113	4274.87D
	025 121 113 D	4155.87D		078 121 113 C	4274.87D
	025 121 113 E	4155.87D		078 121 113 F	4274.87D
	025 121 113 F	4155.87D		078 121 113 J	4274.87D
	030 121 113	4264.84D		07K 121 113 B	4488.80D0
	030 121 113 B	4264.84D		07Z 121 111	4572.105D
	032 121 110 B	3143.87D		191 959 481 A	6017.95D
	032 121 110 B	410989.87D		191 959 481 B	6020.95D
	032 121 110 C	410989.80D		191 959 481 C	6017.95D
	032 121 110 F	3167.83D		1H0 959 481	6037.95D
	032 121 110 J	410989.87D		1H0 959 481 B	6037.95D
	032 121 110 L	410475.87D		251 959 481	6017.95D
	032 121 110 P	3143.87D		251 959 481 G	6087.87D
	032 121 113	4253.87D		251 959 481 H	6087.87D
	032 121 121 G	410475.87D		251 959 481 K	6087.87D
	032 121 121 K	410475.87D		321 959 481 A	6017.95D
	035 121 113	4088.80D		321 959 481 B	6020.95D
	035 121 113 B	4088.87D		321 959 481 C	6017.95D
	036 121 113	3091.92D		321 959 481 D	6017.95D
	036 121 113 A	3091.92D		321 959 481 E	6020.95D
	036 121 113 B	3091.92D		321 959 481 G	6020.95D
	037 121 113	4256.83D60		372 959 481 1	6039.95D
	03G 121 111 A	4820.87D		6U0 959 481 A	6017.95D
	03G 121 113	3472.87D		701 959 481	6037.87D
	03G 121 113 A	4820.87D		701 959 481 C	6037.81D
	03L 121 111 AE	410845.87D		701 959 481 J	6037.87D
	03L 121 111 R	410845.92D		811 959 481	6024.95D
	03L 121 111 S	410845.92D		823 959 481	6010.92D
	03L 121 113 B	410537.92D		823 959 481 A	6010.92D
	03L 121 114 B	410536.92D		823 959 481 F	6010.92D
	044 121 113	4264.87D		823 959 481 G	6010.95D
	050 121 113 C	3141.87D		823 959 481 H	6010.95D
	052 121 113 A	3091.92D		823 959 481 K	6010.95D
	056 121 113	4253.87D		823 959 481 L	6010.92D
	056 121 113 A	4256.80D		867 959 481	6039.95D
	056 121 113 D	4264.87D		893 959 481	6024.95D
	056 121 113 E	4256.71		9.407.0.757.002.4	3145.79D



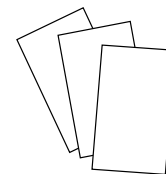

Hersteller Manufacturer Réf. Constructeur	Hersteller-Nr. Manufacturer's Ref. Réf. Constructeurs	Wähler-Nr Wähler-ref. Réf. Wähler
---	---	---

**VOLVO**

J 16 340 540 10	410201.80D
-----------------	------------

J 90 916 030 46	4103.82D
-----------------	----------

J 90 916 030 99	3477.88D
-----------------	----------

J 90 916 540 10	3477.88D
-----------------	----------

1 219 150	4089.82D
-----------	----------

1 544 097	4038.76D
-----------	----------

1 544 098	4038.81D
-----------	----------

1 544 389	4038.65D
-----------	----------

1 544 683	4619.82
-----------	---------

1 661 993	4619.75
-----------	---------

1 665 694	4619.86
-----------	---------

267 235	3029.89
---------	---------

271 417	4272.90D
---------	----------

271 664	4272.90D
---------	----------

272 246	4116.87D1
---------	-----------

272 335	4206.90D
---------	----------

273 307	4089.92D
---------	----------

273 458	4022.88D
---------	----------

273 459	4089.87D
---------	----------

273 480	4122.87D
---------	----------

273 728	4088.87D
---------	----------

273 950	4038.65D
---------	----------

# Vergleichsliste | Cross References

Wahler-Nr Wahler-ref. Réf. Wahler	Hersteller-Nr. Manufacturer's Ref. Réf. Constructeurs	Hersteller Manufacturer Réf. Constructeur	Wahler-Nr Wahler-ref. Réf. Wahler	Hersteller-Nr. Manufacturer's Ref. Réf. Constructeurs	Hersteller Manufacturer Réf. Constructeur
126104 ▲	44 09 180	OPEL	3000.90	04494 469	CHRYSLER
	77 00 101 179	DACIA		04494469	JEEP
	77 00 101 179	RENAULT		5202 8185 AB	CHRYSLER
	77 00 866 387	DACIA		52028185	CHRYSLER
	77 00 866 387	RENAULT		52028185AB	JEEP
	82 00 561 420	DACIA		AT 22963	JOHN DEERE
	82 00 561 420	RENAULT		GTS 298	ROVER
	91 160 216	GM		RE 33705	JOHN DEERE
2389.75/1	77 00 024 756	RENAULT	3004.74	1 518 627	FORD
	F 281 200 050 20	FENDT		1 607 993	FORD
	F 281.200.050.020	DODGE			
	X 815 090 003 000	FENDT			
2391.75			3004.82	13 38 030	OPEL
				13 38 077	OPEL
	1215 2752	MWM		34 402 115	INNOCENTI
	1215 2766	MWM		52 06 139	ASTON MARTIN
	1227 0074	DEUTZ-FAHR	607 200 00 15	MERCEDES-BENZ	
	6 052 5 011 001 1	MWM	94 207 217	ISUZU	
	6 052 5 011 004 2	MWM	97 094 283	GM	
	60 05 000 004	RENAULT			
	60 05 004 616	RENAULT	3004.88D1	1 452 357	FORD
	77 00 024 756	RENAULT		891F 8575 AA	FORD
	F 150 204 050 10	FENDT	3004.92D1	1 472 378	FORD
	F 150 204 050 11	FENDT		1E03-15-171	MAZDA
	F 150.204.050.011	DODGE		5 004 890	FORD
	X 815 090 002 000	FENDT		5 004 891	FORD
	X815.090.002.000	AGCO		6 526 879	FORD
				691F 8575 BA	FORD
		89BM 8575 AC		FORD	
		89BM 8575 AD		FORD	
2393.75	1227 0073	DEUTZ-FAHR	3017.87D2	96 143 939	CHEVROLET
	6 052 5 011 002 4	MWM		96 143 939	DAEWOO
	6 052 5 100 41	MWM			
	60 05 004 616	RENAULT			
3000.75	7483490	PERKINS	3017.92D2	13 38 052	OPEL
				13 38 052	VAUXHALL
3000.80	000 203 64 75	MERCEDES-BENZ	3017.92D50	90 200 836	GM
	001 203 58 75	MERCEDES-BENZ		13 38 015 old number	OPEL
	003 203 22 75	MERCEDES-BENZ			
	PF 52.842	PERKINS			
3000.83	105.00.01.064.00	ALFA ROMEO	3021.88	1 649 194	FORD
	105.00.01.064.01	ALFA ROMEO		40 191 1858	VAUXHALL
	111 727	HOLDER	3021.88D50	1 497 689	FORD
	21200-G3100	NISSAN		1 509 953	FORD
	3156283	CHRYSLER		1 517 858	FORD
	31753-0100	SUBARU		1 520 969	FORD
	406 2141	FIAT		1 635 905	FORD
	406 2172	FIAT		13 38 042	OPEL
	406 5540	FIAT		13 38 042	VAUXHALL
	408 6415	FIAT		5 004 887	FORD
	413 8169	FIAT		6 085 917	FORD
	413 8769	IVECO		6 085 918	FORD
	AT 22961	JOHN DEERE		6 100 630	FORD
	CA 032.221.01	SEAT	6 201 207	FORD	
	GTS 282	ROVER			
	HD 035 A01	HOLDER			

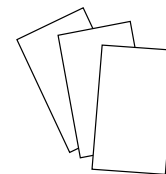

Wahler-Nr Wahler-ref. Réf. Wahler	Hersteller-Nr. Manufacturer's Ref. Réf. Constructeurs	Hersteller Manufacturer Réf. Constructeur	Wahler-Nr Wahler-ref. Réf. Wahler	Hersteller-Nr. Manufacturer's Ref. Réf. Constructeurs	Hersteller Manufacturer Réf. Constructeur
	6 201 247	FORD		13 38 041	OPEL
	800 572	FORD		13 38 041	VAUXHALL
	800 573	FORD			
	800 574	FORD	<b>3054.92D50</b>	02 898 440	GM
	81SF 8575 EA	FORD		02 898 440	VAUXHALL
	81SF 8575 FA	FORD		13 38 016	OPEL
	85HF 8575 AA	FORD		13 38 016	VAUXHALL
	91XM 8575 AA	FORD			
			<b>3061.82</b>	1337 47	PEUGEOT
<b>3021.92D50</b>	6 100 629	FORD		91 500 723	CITROËN
				91 500 723 80	PEUGEOT
<b>3023.87D</b>	415 4312	FIAT		9150 0723 80	FIAT
	415 4313	AUTOBIANCHI			
	415 4313	FIAT	<b>3061.88</b>	1337 49	PEUGEOT
	EA03222101	SEAT		91 500 724 80	PEUGEOT
<b>3029.83</b>	225 070	DAF	<b>3067.83</b>	6071 0617	ALFA ROMEO
	77 00 575 874	RENAULT			
	77 01 348 376	RENAULT	<b>3091.92D</b>	036 121 113	AUDI
				036 121 113	VOLKSWAGEN
<b>3029.86</b>	77 00 619 931	RENAULT		036 121 113 A	AUDI
	77 00 722 762	RENAULT		036 121 113 A	VOLKSWAGEN
	77 01 348 374	RENAULT		036 121 113 B	AUDI
				036 121 113 B	VOLKSWAGEN
<b>3029.89</b>	267 235	VOLVO		052 121 113 A	AUDI
	77 00 727 190	RENAULT		052 121 113 A	VOLKSWAGEN
	77 00 730 540	RENAULT			
	77 01 348 068	RENAULT	<b>3096.75</b>	238 156	SCANIA
				525 076	SCANIA
<b>3032.80</b>	113 095 0	SKODA			
	113 095 091	SKODA	<b>3100.88D</b>	6 994 257	FORD
				95WM 8575 AA	FORD
<b>3032.88</b>	114 095 090	SKODA			
			<b>3100.92D</b>	4 356 548	FORD
<b>3033.78D</b>	5454410R	CITROËN		6 758 566	FORD
	5490459C	CITROËN		YU3E 8575 BA	FORD
	75441833	CITROËN			
	95 492 929	CITROËN	<b>3103.79</b>	9845 0800	FIAT
<b>3033.84D ▲</b>	1337 65	PEUGEOT	<b>3105.87D</b>	754 5958	FIAT
	95 495 311	CITROËN		7545 9580	AUTOBIANCHI
				758 9135	FIAT
<b>3044.80</b>	65 540 40601	INNOCENTI		758 9135	LANCIA
				7581 3190	AUTOBIANCHI
<b>3044.90D1</b>	21200-01B00	NISSAN			
			<b>3109.82D</b>	758 1201	LANCIA
<b>3053.75</b>	1337 26	CITROËN		758 1636	LANCIA
	1337 26	PEUGEOT		7581 635	FIAT
	6 058 784	FORD			
	79 100 118 73	CITROËN	<b>3109.87D</b>	758 1200	FIAT
	79 100 118 73	PEUGEOT		758 1201	FIAT
<b>3053.85</b>	77 01 348 139	RENAULT	<b>3116.82D</b>	77 01 035 736	RENAULT
				77 01 039 156	RENAULT
<b>3054.87D50</b>	02 898 688	GM		9849 8831	FIAT
	13 38 018	OPEL			
	13 38 018	VAUXHALL	<b>3118.82D1</b>	21200-2H600	NISSAN

# Vergleichsliste | Cross References

Wahler-Nr Wahler-ref. Réf. Wahler	Hersteller-Nr. Manufacturer's Ref. Réf. Constructeurs	Hersteller Manufacturer Réf. Constructeur	Wahler-Nr Wahler-ref. Réf. Wahler	Hersteller-Nr. Manufacturer's Ref. Réf. Constructeurs	Hersteller Manufacturer Réf. Constructeur	
3118.82D1	21200-41B00	NISSAN	3119.88D3	90916-03040	TOYOTA	
	21200-85G00	NISSAN		MD 997221	MITSUBISHI	
	21200-99B03	NISSAN		8173-99-152 A	MAZDA	
	21200-P7901	NISSAN		8173-99-152 B	MAZDA	
	21200-P7990	NISSAN		8AG4-15-171	MAZDA	
	21200-V0100	NISSAN		8AX1-15-171	MAZDA	
	21200-V0200	NISSAN		B541-15-171	MAZDA	
	21200-V0201	NISSAN		HE 41-99-152 A	MAZDA	
3118.88D1	21200-2H605	NISSAN	3119.88D4	MD 005131	MITSUBISHI	
	21200-78515	NISSAN		MD 972903	MITSUBISHI	
	21200-85G05	NISSAN		MD 997221	MITSUBISHI	
	21200-85G06	NISSAN		MD 997461	MITSUBISHI	
	21200-P7500	NISSAN		MD 997608	MITSUBISHI	
	21200-P7905	NISSAN	3119.88D5	90916-03040	TOYOTA	
	21200-P7906	NISSAN		90916-03078	TOYOTA	
	21200-P7991	NISSAN		3136.82D50	1337 30	PEUGEOT
	21200-V0105	NISSAN	1338 37		PEUGEOT	
	21200-V0205	NISSAN	1338 83		PEUGEOT	
	21200-V0206	NISSAN	77 01 348 372		RENAULT	
3119.82	17600-83821-000	SUZUKI	79 100 111 01		CITROËN	
	19300-PA0-003	HONDA	79 100 143 90		CITROËN	
	19300-PB2-003	HONDA	79 100 165 60	CITROËN		
	19300-PB2-004	HONDA	96 171 780 80	CITROËN		
	19300-PB2-013	HONDA	9617 1780 80	FIAT		
	19300-PB2-014	HONDA	3136.88D50	1337 27	PEUGEOT	
	19300-PB2-024	HONDA		1338 11	CITROËN	
	19300-PB2-811	HONDA		1338 11	PEUGEOT	
	19300-PB2-812	HONDA		1338 44	CITROËN	
	19300-PB2-815	HONDA		1338 44	PEUGEOT	
	19300-PB2-816	HONDA		79 100 118 80	CITROËN	
	19300-PB2-817	HONDA		96 049 146	CITROËN	
	8124-99-152	MAZDA		96 050 286 80	CITROËN	
	90916-03040-000	DAIHATSU	96 057 087 80	PEUGEOT		
3119.82D3	HE 41-99-152 C	MAZDA	96 057 136	CITROËN		
			96 057 136 80	PEUGEOT		
3119.82D4	MD 001370	MITSUBISHI	96 196 379 80	PEUGEOT		
	MD 005371	MITSUBISHI	3141.87D	050 121 113 C	AUDI	
	MD 008086	MITSUBISHI		050 121 113 C	SEAT	
	MD 075460	MITSUBISHI		050 121 113 C	SKODA	
	MD 117759	MITSUBISHI		050 121 113 C	VOLKSWAGEN	
	MD 126168	MITSUBISHI		06B 121 113 A	VOLKSWAGEN	
	MD 972905	MITSUBISHI		3142.90D	0003179V009	SMART
	MD 972908	MITSUBISHI	0003179V010		SMART	
	MD 997217	MITSUBISHI	160 200 03 15		MERCEDES-BENZ	
	MD 997219	MITSUBISHI	Q0003179V010000000		SMART	
	MD 997220	MITSUBISHI	3143.87D		032 121 110 B	AUDI
	MD 997602	MITSUBISHI			032 121 110 B	SEAT
	MD 997603	MITSUBISHI			032 121 110 B	SKODA
	MD 997607	MITSUBISHI			032 121 110 B	VOLKSWAGEN
3119.82D5	90916-03055	TOYOTA				
3119.88	3 257 449	FORD				
	90048-33021-000	DAIHATSU				

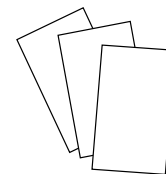

Wahler-Nr Wahler-ref. Réf. Wahler	Hersteller-Nr. Manufacturer's Ref. Réf. Constructeurs	Hersteller Manufacturer Réf. Constructeur	Wahler-Nr Wahler-ref. Réf. Wahler	Hersteller-Nr. Manufacturer's Ref. Réf. Constructeurs	Hersteller Manufacturer Réf. Constructeur
	032 121 110 P	AUDI	<b>3344.75</b>	11 53 1 260 720	BMW
	032 121 110 P	SEAT			
	032 121 110 P	SKODA	<b>3344.80</b>	11 53 1 253 248	BMW
	032 121 110 P	VOLKSWAGEN		11 53 1 253 249	BMW
				11 53 9 055 587	BMW
<b>3145.79D</b>	062 121 111 A	VOLKSWAGEN			
	062 121 111 B	VOLKSWAGEN	<b>3345.79</b>	0004218650	SEAT
	9 407 0 757 002 4	MWM		421 8649	AUTOBIANCHI
	9.407.0.757.002.4	VOLKSWAGEN		4218 6500	FIAT
<b>3146.90D</b>	0004698V002	SMART			
	0004698V003	SMART	<b>3355.80D</b>	594 2240	FIAT
	660 200 03 15	MERCEDES-BENZ		762 8527	FIAT
	660 200 05 15	SMART			
			<b>3356.80D</b>	8234 2688	LANCIA
<b>3151.87D</b>	4652 3118	FIAT			
	4673 7644	FIAT	<b>3360.87D</b>	762 8417	FIAT
<b>3159.82D</b>	1337 48	PEUGEOT	<b>3361.87D</b>	596 6787	FIAT
	595 0116	FIAT		596 9749	FIAT
	756 4583	FIAT		762 6622	FIAT
	761 5234	FIAT		SE 020 032 221 A	SEAT
	761 5235	FIAT			
			<b>3373.80D</b>	765 6384	FIAT
<b>3163.88D</b>	4652 2664	FIAT		765 6385	FIAT
	4652 2664	LANCIA			
	4677 6217	FIAT	<b>3378.80</b>	761 3433	FIAT
<b>3164.88</b>	4653 6104	FIAT	<b>3383.87</b>	755 4544	FIAT
	4677 6218	FIAT		769 2450	FIAT
				769 6535	FIAT
<b>3166.89D</b>	11061-00QAE	NISSAN			
	77 00 110 716	RENAULT	<b>3431.80D</b>	1336 A7	CITROËN
	82 00 660 882	DACIA		1336 A7	PEUGEOT
	82 00 660 882	RENAULT		4681 8413	FIAT
				599 9818	LANCIA
<b>3167.83D</b>	032 121 110 F	AUDI		759 7659	FIAT
	032 121 110 F	SEAT		759 9824	FIAT
	032 121 110 F	SKODA		762 5346	FIAT
	032 121 110 F	VOLKSWAGEN		762 5347	FIAT
<b>3169.79D</b>	50 404 5799	IVECO	<b>3457.90D</b>	271 200 00 15	MERCEDES-BENZ
	50 408 4365	IVECO		271 203 03 75	MERCEDES-BENZ
<b>3171.82D</b>	50 401 7209	IVECO	<b>3463.89D</b>	1336 N5	CITROËN
				1336 N5	PEUGEOT
<b>3174.89D</b>	77 00 868 980	RENAULT		1336 Q1	CITROËN
				1336 Q1	PEUGEOT
<b>3300.80D</b>	779 4132	FIAT		96 300 66 780	CITROËN
				96 300 667 80	PEUGEOT
<b>3301.80D</b>	777 0416	FIAT			
			<b>3466.89D</b>	44 08 334	OPEL
<b>3302.80D</b>	774 1883	FIAT		60 01 543 366	RENAULT
				77 00 872 554	DACIA
<b>3333.87</b>	21080-13060-10	LADA		77 00 872 554	RENAULT
	2108-13060-10	LADA		77 00 872 635	RENAULT
	21081-3060-11	LADA		82 00 772 985	DACIA
				82 00 772 985	RENAULT

# Vergleichsliste | Cross References

Wahler-Nr Wahler-ref. Réf. Wahler	Hersteller-Nr. Manufacturer's Ref. Réf. Constructeurs	Hersteller Manufacturer Réf. Constructeur	Wahler-Nr Wahler-ref. Réf. Wahler	Hersteller-Nr. Manufacturer's Ref. Réf. Constructeurs	Hersteller Manufacturer Réf. Constructeur
3466.89D	91 159 950	GM	3478.82D	21200-4M500	NISSAN
	91 159 950	VAUXHALL		21200-77A05	NISSAN
3467.85D	13 38 075	OPEL	21200-77A65	NISSAN	
	8-79312-726-0	ISUZU	21200-77A66	NISSAN	
	8-94360-227-0	ISUZU	21200-86J00	NISSAN	
	8-97087-130-2	ISUZU	21200-86J01	NISSAN	
	97 087 130	GM	21200-90J00	NISSAN	
	97 087 130	VAUXHALL	21200-90J10	NISSAN	
			21200-9F600	NISSAN	
3468.88D	13 38 056	OPEL	90080-23002	TOYOTA	
	17670-78E00	SUZUKI	90916-03060	TOYOTA	
	8-94123-295-0	ISUZU	90916-03090	TOYOTA	
	8-94123-295-1	ISUZU	90916-03090-000	DAIHATSU	
	8-94372-762-0	ISUZU	90916-03095	TOYOTA	
	8AG1-15-171	MAZDA	90916-03096	TOYOTA	
	8AG1-15-171A	MAZDA	90916-03109	TOYOTA	
	8AG2-15-171	MAZDA	90916-03115	TOYOTA	
	8AG2-15-171A	MAZDA			
	8AG6-15-171	MAZDA	4646 4992	FIAT	
	8AG7-15-171	MAZDA	4651 3506	FIAT	
	8AG8-15-171	MAZDA	4652 3733	FIAT	
	8AZ1-15-171	MAZDA	4677 6216	FIAT	
	94 372 762	GM			
	94 372 762	VAUXHALL	3481.88D	4646 4992	FIAT
	RF03-15-171A	MAZDA		4651 3506	FIAT
			4652 3733	FIAT	
			4677 6216	FIAT	
		3483.89D	1338 A0	CITROËN	
			1338 A0	PEUGEOT	
			96 300 666 80	CITROËN	
			96 300 666 80	PEUGEOT	
3469.91D	77 00 742 617	RENAULT	3484.87D	775 9596	FIAT
	77 00 858 802	RENAULT			
			3485.87D	772 2107	FIAT
3470.89D50	3 344 616	VOLVO	3497.88D	1 096 283	FORD
	3 345 628	VOLVO		1338 F5	CITROËN
	44 02 719	OPEL		1338 F5	PEUGEOT
	77 00 723 945	RENAULT		XS7Q 8575 AA	FORD
	77 00 866 896	RENAULT			
	77 00 872 314	RENAULT	3498.88D	0K710-15-171	KIA
	77 01 348 373	RENAULT		0K9FC-15-171	KIA
	9 110 719	GM		8AB1-15-171	MAZDA
	9 110 719	VAUXHALL		8AB5-15-171	MAZDA
	M-474877	MITSUBISHI		8AB8-15-171	MAZDA
M-863985	MITSUBISHI		8ABE-15-171	MAZDA	
			8AG3-15-171	MAZDA	
3472.87D	03G 121 113	AUDI		8AG5-15-171	MAZDA
	03G 121 113	SEAT		8AK1-15-171	MAZDA
	03G 121 113	SKODA		8AN1-15-171	MAZDA
	03G 121 113	VOLKSWAGEN		8AU1-15-171	MAZDA
	MN 980137	MITSUBISHI		8AU-15-171	MAZDA
				AB6-15-171	MAZDA
3477.88D	16340-54010	TOYOTA		B6H-15-171	MAZDA
	90916-03043	TOYOTA		B6H-15-171 A	MAZDA
	90916-03062	TOYOTA		BP6F-15-171	MAZDA
	90916-03072	TOYOTA		BPD3-15-171	MAZDA
	90916-03099	TOYOTA		E5D3-15-171	MAZDA
	90916-03106	TOYOTA		F201-15-171	MAZDA
	90916-54010	TOYOTA			
	J 90 916 030 99	VOLKSWAGEN			
	J 90 916 540 10	VOLKSWAGEN			



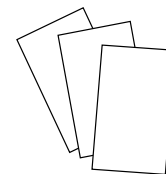

Wahler-Nr Wahler-ref. Réf. Wahler	Hersteller-Nr. Manufacturer's Ref. Réf. Constructeurs	Hersteller Manufacturer Réf. Constructeur	Wahler-Nr Wahler-ref. Réf. Wahler	Hersteller-Nr. Manufacturer's Ref. Réf. Constructeurs	Hersteller Manufacturer Réf. Constructeur		
3499.82D	KE5D3-15-171	KIA	4017.82	77 01 026 647	RENAULT		
	ZZ40-15-171	MAZDA		3059 676 R 1	INTER. HARV. IHC		
	0223-15-171	MAZDA		3059 676 R 91	INTER. HARV. IHC		
	0419-15-171	MAZDA		3059 676 R 92	INTER. HARV. IHC		
	0419-99-152	MAZDA		3228 046 R 2	INTER. HARV. IHC		
	8AB7-15-171	MAZDA		3228 046 R1	INTER. HARV. IHC		
	8AB9-15-171	MAZDA		4022.82D	75 02 297	SAAB	
	8ABC-15-171	MAZDA			93 37 551	SAAB	
	B366-15-171	MAZDA			94 214 962	ISUZU	
	B3H3-15-171	MAZDA		4022.82D1	754 0318	FIAT	
	B3H8-15-171A	MAZDA			754 0318	LANCIA	
	HE 41-99-152C	MAZDA			761 5234	ALFA ROMEO	
	HE 41-99-152D	MAZDA			765 6567	FIAT	
3499.88D	8173-15-152 C	MAZDA	4022.88D	273 458	VOLVO		
	8173-15-171	MAZDA		83 89 512	SAAB		
	8173-99-152	MAZDA		4022.92D	93 20 284	SAAB	
	8173-99-152 A	MAZDA	4026.89		131 666.00	TALBOT	
	8173-99-152 B	MAZDA			4029.81	466 017	VOLVO
	8ABA-15-171	MAZDA		4030.70		4 901 2012 F	VM
	8ABB-15-171	MAZDA	461.0943			SAURER	
	8ABB-15-171A	MAZDA	4033.82D		422 0309	FIAT	
	8ABD-15-171	MAZDA		443 7481	FIAT		
	8AG4-15-171	MAZDA		4038.65D	1 544 389	VOLVO	
	8AX1-15-171	MAZDA	273 950		VOLVO		
	B541-15-171	MAZDA	3 831 426		VOLVO		
	4003.86	6050 4230	ALFA ROMEO	4038.71D	424 370	VOLVO	
			466 127		VOLVO		
4006.82D	059 121 113 A	AUDI	4038.76D	875 788	VOLVO		
	059 121 113 A	VOLKSWAGEN		1 544 097	VOLVO		
	059 121 113 B	AUDI		273 951	VOLVO		
	059 121 113 B	VOLKSWAGEN		273 953	VOLVO		
	8AB3 15 171	MAZDA		875 787	VOLVO		
	C28067	JAGUAR		4038.81D	1 544 098	VOLVO	
	C33012	JAGUAR			273 952	VOLVO	
C37129	JAGUAR	4049.80D	617 200 03 15	MERCEDES-BENZ			
4007.80D	1000208309		LOMBARDINI	617 200 11 15	MERCEDES-BENZ		
	1285 0152		DEUTZ-FAHR	4049.80D1	617 200 18 15	MERCEDES-BENZ	
	1285 1663		DEUTZ-FAHR		4064.75D	002 203 82 75	MERCEDES-BENZ
	9195 057		LOMBARDINI			116 200 00 15	MERCEDES-BENZ
	9195 1240	LOMBARDINI	4078.65D	004 203 65 75		MERCEDES-BENZ	
ED0091951240S	LOMBARDINI						
4008.74D	465 5782	FIAT					
	467 4169	FIAT					
	470 3624	FIAT					
	470 3625	FIAT					
	482 3226	FIAT					
4008.79D	104 9195 092	LOMBARDINI					
	468 4390	IVECO					
	470 3088	IVECO					
	475 0024	FIAT					
	6071 3535	ALFA ROMEO					

# Vergleichsliste | Cross References

Wahler-Nr Wahler-ref. Réf. Wahler	Hersteller-Nr. Manufacturer's Ref. Réf. Constructeurs	Hersteller Manufacturer Réf. Constructeur	Wahler-Nr Wahler-ref. Réf. Wahler	Hersteller-Nr. Manufacturer's Ref. Réf. Constructeurs	Hersteller Manufacturer Réf. Constructeur	
4078.71D	002 203 16 75	MERCEDES-BENZ	410016.98D	1 473 089	FORD	
	002 203 31 75	MERCEDES-BENZ		1 473 090	FORD	
	110 200 09 15	MERCEDES-BENZ		7S7G 6L721 AA	FORD	
4078.75D	770275	PEGASO	410048.88D	7S7G 6L721 AB	FORD	
4078.79D	001 203 90 75	MERCEDES-BENZ	410049.88D	13 38 020	OPEL	
	002 203 35 75	MERCEDES-BENZ		5519 4271	FIAT	
	002 203 37 75	MERCEDES-BENZ		5520 2373	FIAT	
	002 203 38 75	MERCEDES-BENZ		63 38 039	OPEL	
	002 203 46 75	MERCEDES-BENZ		93 18 4200	OPEL	
	002 203 72 75	MERCEDES-BENZ				
	002 203 78 75	MERCEDES-BENZ		13 38 039	OPEL	
4078.87D	100 200 07 15	MERCEDES-BENZ		13 38 154	OPEL	
	001 203 91 75	MERCEDES-BENZ		13 38 275	OPEL	
	002 203 76 75	MERCEDES-BENZ		17690-79J50	SUZUKI	
	002 203 81 75	MERCEDES-BENZ		55 20 3388	SAAB	
	100 200 05 15	MERCEDES-BENZ		55 202 510	GM	
	102 200 08 15	MERCEDES-BENZ		55 202 510	VAUXHALL	
	102 200 14 15	MERCEDES-BENZ		5518 7784	FIAT	
	102 200 15 15	MERCEDES-BENZ		5520 2510	ALFA ROMEO	
	102 200 19 15	MERCEDES-BENZ		5520 2510	FIAT	
	110 200 01 11	MERCEDES-BENZ		5520 3388	FIAT	
	110 200 05 15	MERCEDES-BENZ		7175 4778	ALFA ROMEO	
				7175 4778	FIAT	
	4078.92D	004 203 86 75	MERCEDES-BENZ		93 179 136	GM
		110 200 19 15	MERCEDES-BENZ		93 179 136	VAUXHALL
4083.79 •	738 0833	LIEBHERR	410055.87D ▲	642 200 08 15	MERCEDES-BENZ	
4083.83D50	001 203 69 75	MERCEDES-BENZ	410058.84D	1338 38	CITROËN	
	002 203 04 75	MERCEDES-BENZ		1338 38	PEUGEOT	
	002 203 53 75	MERCEDES-BENZ		96 145 00 980	CITROËN	
4088.80D	035 121 113	AUDI	410075.79D ▲	1336 AA	CITROËN	
	035 121 113	VOLKSWAGEN		1336 AA	PEUGEOT	
				50 413 2246	IVECO	
4088.87D	035 121 113 B	AUDI	410081.79D	50 415 0562	FIAT	
	035 121 113 B	VOLKSWAGEN		50 415 0562	IVECO	
	273 728	VOLVO				
4089.82D	1 219 150	VOLVO	410086.97D0	11 53 7 536 655	BMW	
	463 433	VOLVO		11 53 7 544 788	BMW	
				11 53 7 549 476	BMW	
4089.87D	273 459	VOLVO	410087.97D0			
				11 53 7 550 172	BMW	
4089.92D	273 307	VOLVO	410090.88D	5519 3669	FIAT	
				5519 4029	FIAT	
				5520 2176	FIAT	
				5523 9819	FIAT	
4091.82D	435 1196	FIAT	410131.88D	1 086 282	FORD	
	4355 8460	AUTOBIANCHI		1E07-15-171	MAZDA	
	440 9254	FIAT		1E07-15-171 A	MAZDA	
4094.71/1	4409 2540	AUTOBIANCHI		6 169 774	FORD	
	0117 2667	DEUTZ-FAHR		89FF 8575 AB	FORD	
	0117 2668	DEUTZ-FAHR				
410007.87D	772 9959	FIAT				

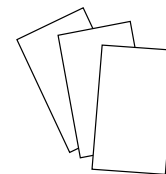

Wahler-Nr Wahler-ref. Réf. Wahler	Hersteller-Nr. Manufacturer's Ref. Réf. Constructeurs	Hersteller Manufacturer Réf. Constructeur	Wahler-Nr Wahler-ref. Réf. Wahler	Hersteller-Nr. Manufacturer's Ref. Réf. Constructeurs	Hersteller Manufacturer Réf. Constructeur
410171.87D	5080 146 AB	DODGE	410183.88D	17600-77820	SUZUKI
	611 200 02 15	MERCEDES-BENZ		17600-85821	SUZUKI
	611 200 07 15	MERCEDES-BENZ		17670-50G10	SUZUKI
	611 203 04 75	MERCEDES-BENZ		17670-50G20	SUZUKI
	611 203 05 75	MERCEDES-BENZ		17670-67H00	SUZUKI
	611 203 15 75	MERCEDES-BENZ		17670-76G10	SUZUKI
	611 203 19 75	MERCEDES-BENZ		17670-77G10	SUZUKI
	646 200 12 15	MERCEDES-BENZ		17670-85020	SUZUKI
410174.92D	646 200 00 15	MERCEDES-BENZ	410184.89D	21200-KA070	SUBARU
	646 200 11 15	MERCEDES-BENZ		96 610 574	GM
	646 203 02 75	MERCEDES-BENZ		1336 Q2	CITROËN
410176.82D0	21200-57J00	NISSAN	410201.80D	1336 Q2	PEUGEOT
	21200-57J15	NISSAN		96â485 426 80	PEUGEOT
410176.88D0	21200-57J05	NISSAN	410224.78D	90048-33088	DAIHATSU
410178.82D	90916-03088 90916-03101 90916-03120	TOYOTA TOYOTA TOYOTA		410224.78D	90916-03122
			J 16 340 540 10		VOLKSWAGEN
			410179.84D	90048-33078 90048-33083 90048-33092	DAIHATSU DAIHATSU DAIHATSU
19300-PDA-E01	HONDA				
19300-PJ7-003	HONDA				
410180.82D	MD 174233 MD 194988 MD 194988 MD 348937 MD 351495 MD 997644 ME 220538 ME 241816	MITSUBISHI CHRYSLER MITSUBISHI MITSUBISHI MITSUBISHI MITSUBISHI MITSUBISHI MITSUBISHI	410224.78D	19300-PJ7-004	HONDA
				19300-PM3-003	HONDA
				19300-PM3-004	HONDA
				19300-PR3-003	HONDA
				19300-PT0-003	HONDA
				19300-PT0-004	HONDA
				19301-P08-000	HONDA
				19301-P08-305	HONDA
19301-P08-306	HONDA				
410181.82D	90916-03097 90916-03118	TOYOTA TOYOTA	410224.78D	19301-P08-315	HONDA
				19301-P08-316	HONDA
410182.84D	90048-33047 90048-33056	DAIHATSU DAIHATSU	410224.78D	19301-P10-307	HONDA
				19301-P1K-307	HONDA
410183.82D	17600-85811 17670-50G00 17670-76A00 17670-76A01 17670-76G00 17670-77G00 17670-82810-000 21200-KA010 21200-KA050 21200-KA150 21200-KA151 21200-KA152 21200-KA153 21200-KA154 94 580 182	SUZUKI SUZUKI SUZUKI SUZUKI SUZUKI SUZUKI SUZUKI SUBARU SUBARU SUBARU SUBARU SUBARU SUBARU SUBARU SUBARU GM	410224.82D	19301-PAA-305	HONDA
				19301-PAA-306	HONDA
				19301-PDF-305	HONDA
				19301-PLC-305	HONDA
				19301-PLC-315	HONDA
				19301-REA-305	HONDA
				19301-RME-305	HONDA
				19301-RP3-305	HONDA
				5-86000-349-0	ISUZU
				5-86000-350-0	ISUZU
				5-86012-056	ISUZU
				5-86014-381-0	ISUZU
				5-86018-963	ISUZU
				5-86018-964-0	ISUZU
				5-86019-507-0	ISUZU
				5-86019-513-0	ISUZU
410183.82D	94 580 182	GM	410224.82D	19301-P07-306	HONDA
				19301-P07-316	HONDA
				19301-PWA-305	HONDA
				19301-PZA-305	HONDA
410183.82D	94 580 182	GM	410224.82D	19301-RNA-305	HONDA
				19301-RNA-305	HONDA
				19301-RNA-305	HONDA
				19301-RNA-305	HONDA

# Vergleichsliste | Cross References

Wahler-Nr Wahler-ref. Réf. Wahler	Hersteller-Nr. Manufacturer's Ref. Réf. Constructeurs	Hersteller Manufacturer Réf. Constructeur	Wahler-Nr Wahler-ref. Réf. Wahler	Hersteller-Nr. Manufacturer's Ref. Réf. Constructeurs	Hersteller Manufacturer Réf. Constructeur
410224.82D	19301-RNA-306	HONDA	410348.82D	25500-23001	HYUNDAI
	19301-RNA-307	HONDA		410351.88D	25500-22600
	5-86008138	ISUZU	410225.78D		19301-PNA-003
410226.78D	19301-RAF-003	HONDA	410352.82D		0K2A-15-171
	19301-RAF-004	HONDA		410352.88D	0K2C0-15-171A
410228.82D	17570-74000	SUZUKI	410389.103D ▲	271 200 01 15	MERCEDES-BENZ
	17570-740001	SUZUKI		271 200 02 15	MERCEDES-BENZ
	17600-83810	SUZUKI		271 200 03 15	MERCEDES-BENZ
	17600-83811	SUZUKI	410475.87D	032 121 110 L	AUDI
	17600-83820	SUZUKI		032 121 110 L	SEAT
	17600-83821	SUZUKI		032 121 110 L	SKODA
	17600-83822	SUZUKI		032 121 110 L	VOLKSWAGEN
	17600-83823	SUZUKI		032 121 121 G	AUDI
	17600-85830	SUZUKI		032 121 121 G	SEAT
	17600-85831	SUZUKI		032 121 121 G	SKODA
	17670-73000	SUZUKI		032 121 121 G	VOLKSWAGEN
	17670-73020	SUZUKI		032 121 121 K	AUDI
	17670-73021	SUZUKI		032 121 121 K	SEAT
	17670-83000	SUZUKI	032 121 121 K	SKODA	
	17670-83001	SUZUKI	032 121 121 K	VOLKSWAGEN	
	17670-83010	SUZUKI	410488.88D	21200-BX000	NISSAN
17670-83011	SUZUKI	4105.71D		002 203 39 75	MERCEDES-BENZ
410229.82D	17670-63J00		SUZUKI	003 203 29 75	MERCEDES-BENZ
	17670-65D00		SUZUKI	003 203 32 75	MERCEDES-BENZ
	17670-77E00		SUZUKI	003 203 74 75	MERCEDES-BENZ
	17670-85C00		SUZUKI	003 203 79 75	MERCEDES-BENZ
	7174 2133	FIAT	004 203 84 75	MERCEDES-BENZ	
410230.78D	21200-AA071	SUBARU	005 203 28 75	MERCEDES-BENZ	
	21200-AA072	SUBARU	4105.75D	474 9724	IVECO
	21210-AA030	SUBARU		4105.79D	003 203 91 75
410231.82D	11 53 7 791 072	BMW	003 203 92 75		MERCEDES-BENZ
	90916-03093	TOYOTA	004 203 85 75		MERCEDES-BENZ
	90916-03123	TOYOTA	005 203 27 75	MERCEDES-BENZ	
410262.91D	5278 144 AA	CHRYSLER	4105.83D	002 203 32 75	MERCEDES-BENZ
410263.91D	11 53 1 485 847	BMW		002 203 45 75	MERCEDES-BENZ
	11 53 1 501 173	BMW		002 203 47 75	MERCEDES-BENZ
	11 53 7 596 787	BMW		002 203 49 75	MERCEDES-BENZ
	4693 117 AA	CHRYSLER		002 203 56 75	MERCEDES-BENZ
410289.81D	50 425 8346	IVECO	002 203 59 75	MERCEDES-BENZ	
	50 432 0545	IVECO	002 203 79 75	MERCEDES-BENZ	
4103.82D	90916-03046	TOYOTA	002 203 90 75	MERCEDES-BENZ	
	90916-03046-000	DAIHATSU	003 203 14 75	MERCEDES-BENZ	
	90916-03065	TOYOTA	003 203 28 75	MERCEDES-BENZ	
	90916-03069	TOYOTA	003 203 31 75	MERCEDES-BENZ	
	J 90 916 030 46	VOLKSWAGEN	003 203 73 75	MERCEDES-BENZ	
			003 203 78 75	MERCEDES-BENZ	
		004 203 83 75	MERCEDES-BENZ		

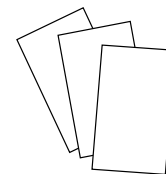

Wahler-Nr Wahler-ref. Réf. Wahler	Hersteller-Nr. Manufacturer's Ref. Réf. Constructeurs	Hersteller Manufacturer Réf. Constructeur	Wahler-Nr Wahler-ref. Réf. Wahler	Hersteller-Nr. Manufacturer's Ref. Réf. Constructeurs	Hersteller Manufacturer Réf. Constructeur	
410511.88D	005 203 26 75	MERCEDES-BENZ	410538.89D	03L 121 113 B	SKODA	
	373 203 70 75	MERCEDES-BENZ		03L 121 113 B	VOLKSWAGEN	
	83 129 996 050	EVOBUS		11060-00QAF	NISSAN	
	4679 0294	FIAT		17690-67JG0	SUZUKI	
	4679 0294	LANCIA		82 00 112 054	RENAULT	
410512.88D	6081 6681	ALFA ROMEO	410588.88D	17690-84E50-000	SUZUKI	
	4654 6375	FIAT		47 08 757	OPEL	
	4654 6375	LANCIA		55 182 499	GM	
	6081 5681	ALFA ROMEO		55 182 499	VAUXHALL	
410513.88D	4652 0785	FIAT	410589.88D	5519 9402	FIAT	
	4652 0785	LANCIA		63 38 022	OPEL	
	779 4218	FIAT		93 177 343	GM	
	779 4218	LANCIA		93 177 343	VAUXHALL	
410514.88D	6065 3946	FIAT	410590.88D	93 19 3581	GM	
	6081 4382	FIAT		4678 5392	FIAT	
410515.88D	4641 7962	FIAT	410591.88D	6066 3619	ALFA ROMEO	
410516.88D	779 1178	FIAT	410608.86D	4675 8586	FIAT	
410517.83D	11061-00QAB	NISSAN	410692.71D	50 409 6443 Kit	IVECO	
	11061-00QAC	NISSAN		592 1206	FIAT	
	44 08 928	OPEL	410705.89D	1336 Z0	CITROËN	
	44 32 983	OPEL		1336 Z0	PEUGEOT	
	82 00 074 349	RENAULT	410758.83D	96 472 659 80	PEUGEOT	
	82 00 674 369	RENAULT		50 10 295 225 2x Kit	RENAULT	
	91 160 168	GM	410763.82D	9849 8322 Kit	IVECO	
	93 198 017	GM		410765.90D ▲	31293556	VOLVO
410517.89D	11060-AW300	NISSAN	410766.103D0 ▲	11 53 7 601 158	BMW	
	11061-00QAD	NISSAN		410792.95D	11 53 1 247 125	BMW
	44 04 305	OPEL	410518.89D	11 53 1 432 881	BMW	
	82 00 074 346	RENAULT		11 53 1 739 755	BMW	
	82 00 674 368	RENAULT		410793.95D	11 51 7 500 597	BMW
9 112 305	GM	410520.92D ▲	410806.88D	PEL 000170	ROVER	
77 00 112 491	RENAULT		410530.89D	410808.88D	GTS 301	ROVER
77 01 474 248	RENAULT			PEL 10016	ROVER	
410536.92D	708 3256	FIAT	410828.82D	50 00 684 865 Kit	RENAULT	
	93 275 736	GM		410828.82D0	50 00 684 865	RENAULT
	93235636	BUICK			410828.86D	50 00 691 267 Kit
	77 00 109 641	RENAULT		410537.92D	410828.86D0	50 00 691 267
77 01 474 249	RENAULT	03L 121 113 B	AUDI			
410537.92D	03L 121 114 B	AUDI	410828.86D0	03L 121 113 B	SEAT	
	03L 121 114 B	SEAT				
	03L 121 114 B	SKODA				
	03L 121 114 B	VOLKSWAGEN				

# Vergleichsliste | Cross References

Wahler-Nr Wahler-ref. Réf. Wahler	Hersteller-Nr. Manufacturer's Ref. Réf. Constructeurs	Hersteller Manufacturer Réf. Constructeur	Wahler-Nr Wahler-ref. Réf. Wahler	Hersteller-Nr. Manufacturer's Ref. Réf. Constructeurs	Hersteller Manufacturer Réf. Constructeur
410845.87D	03L 121 111 AE	AUDI	411040.83D	11060-00QAJ	NISSAN
	03L 121 111 AE	SEAT		82 00 400 553	RENAULT
	03L 121 111 AE	SKODA		82 00 558 751	RENAULT
	03L 121 111 AE	VOLKSWAGEN			
410845.92D	03L 121 111 R	AUDI	411042.89D	82 00 267 349	RENAULT
	03L 121 111 R	SEAT		82 00 558 766	RENAULT
	03L 121 111 R	SKODA	411043.89D	11060-BN700	NISSAN
	03L 121 111 R	VOLKSWAGEN		11061-00Q0E	NISSAN
	03L 121 111 S	AUDI		11061-00QAG	NISSAN
	03L 121 111 S	SEAT		11061-00QAL	NISSAN
	03L 121 111 S	SKODA		17690 84A00	SUZUKI
	03L 121 111 S	VOLKSWAGEN		17690-84A10	SUZUKI
410864.71D0	81.06401.0019	MAN	17690-84A11	SUZUKI	
	81.06401.0042	MAN	82 00 039 885	RENAULT	
410864.79D0	81.06401.0037	MAN	82 00 171 021	RENAULT	
	81.06401.0046	MAN	82 00 244 402	RENAULT	
410864.83D0	81.06401.0038	MAN	82 00 374 994	DACIA	
	81.06401.0045	MAN	82 00 374 994	RENAULT	
	9011 0080	DEUTZ-FAHR	82 00 558 783	DACIA	
			82 00 558 783	RENAULT	
410871.80D ▲	0489 2642 AC	CHRYSLER	82 00 954 285	RENAULT	
	5521 5006	ALFA ROMEO	411045.82D	50 10 284 184	RENAULT
	5521 5006	FIAT		657 GC 324 A-P80	MACK
410937.82D ▲	50 438 7382	IVECO	411133.80D	129 3885 / F75-85-95	DAF
				129 3885 / F75-85-95	PACCAR
410956.83D	777 3790	FIAT	411135.83D	168 4900 / CF 75	DAF
410989.80D	032 121 110 C	VOLKSWAGEN		168 4900 / CF 75	PACCAR
410989.87D	032 121 110 B	SEAT	411135.87D	166 1375 / CF 75	DAF
	032 121 110 B	SKODA		166 1375 / CF 75	PACCAR
	032 121 110 B	VOLKSWAGEN	411186.87D	06D 121 111 G	AUDI
	032 121 110 J	SEAT		06D 121 111 G	SEAT
	032 121 110 J	SKODA		06D 121 111 G	SKODA
	032 121 110 J	VOLKSWAGEN		06D 121 111 G	VOLKSWAGEN
410994.88D	4680 4764	FIAT	411187.87D	06F 121 111 F	AUDI
411004.80D	1 423 451	SCANIA		06F 121 111 F	SEAT
	1 799 757	SCANIA		06F 121 111 F	SKODA
	1 800 909	SCANIA		06F 121 111 F	VOLKSWAGEN
	1 849 060	SCANIA			
411039.83D	11061-00Q0D	NISSAN	411193.82D	12 61 5097	SAAB
	11061-00QAM	NISSAN		12 615 097	GM
	17690-84A50-000	SUZUKI		12 615 097	VAUXHALL
	82 00 244 023	RENAULT		12 62 2410	SAAB
	82 00 400 554	DACIA		12 622 410	GM
	82 00 400 554	RENAULT		12 622 410	VAUXHALL
	82 00 558 758	DACIA		13 38 007	OPEL
	82 00 558 758	RENAULT		13 38 008	OPEL
	82 00 954 288	DACIA		13 38 034	OPEL
	82 00 954 288	RENAULT		13 38 427	OPEL
				21 018 811	GM



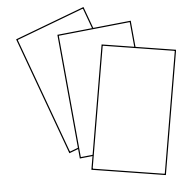

Wahler-Nr Wahler-ref. Réf. Wahler	Hersteller-Nr. Manufacturer's Ref. Réf. Constructeurs	Hersteller Manufacturer Réf. Constructeur	Wahler-Nr Wahler-ref. Réf. Wahler	Hersteller-Nr. Manufacturer's Ref. Réf. Constructeurs	Hersteller Manufacturer Réf. Constructeur	
411241.82D	21 018 811	VAUXHALL	411477.89D ▲	93 198 576	VAUXHALL	
	5177 0698	ALFA ROMEO		93 198 646	GM	
	7350 2809	FIAT		93 198 646	VAUXHALL	
	90 53 7453	SAAB				
	90 53 7811	SAAB		11 06 023 09R	RENAULT	
	90 537 453	GM		17690-84A51	SUZUKI	
	90 537 453	VAUXHALL		82 00 248 531	RENAULT	
	90 537 605	GM		82 00 558 779	RENAULT	
	90 537 605	VAUXHALL				
	90 537 811	GM		82 00 954 289	RENAULT	
411442.83D ▲	21200-ED000	NISSAN	4115.92D	13 38 046	OPEL	
	21200-ED00A	NISSAN		13 38 046	VAUXHALL	
	77 01 068 770	RENAULT		90 009 956	GM	
				90 009 956	VAUXHALL	
411475.89D ▲	11 06 030 26R	RENAULT	411545.82D ▲	90916-03079	LEXUS	
	11 06 055 36R	RENAULT		90916-03079	TOYOTA	
	11060-00Q0K	NISSAN		90916-03081	LEXUS	
	11060-00Q0S	NISSAN		90916-03081	TOYOTA	
	82 00 954 328	RENAULT				
	11060-00Q0C	NISSAN		11 53 1 436 042	BMW	
	11060-00Q0E	NISSAN		11 53 1 437 085	BMW	
	11060-00QAL	NISSAN				
	82 00 380 898	RENAULT		11 53 7 552 403	BMW	
	82 00 656 419	RENAULT				
411476.83D ▲	82 00 656 420	RENAULT	411573.105D ▲	166 203 00 75	MERCEDES-BENZ	
	82 00 699 392	RENAULT		166 203 01 75	MERCEDES-BENZ	
	82 00 703 139	RENAULT		166 203 02 75	MERCEDES-BENZ	
	82 00 801 570	RENAULT				
	82 00 801 571	RENAULT		266 203 02 75	MERCEDES-BENZ	
	82 00 907 229	RENAULT		266 203 04 75	MERCEDES-BENZ	
	82 00 907 234	RENAULT		266 203 06 75	MERCEDES-BENZ	
	11061-00Q0A	NISSAN		411574.102D ▲	1338 001	OPEL
	11061-00Q0B	NISSAN			1338 098	OPEL
	11061-00Q0G	NISSAN			24 456 401	GM
11061-00Q0K	NISSAN	24 456 401	VAUXHALL			
11061-00Q0L	NISSAN	6338 005	OPEL			
44 33 121	OPEL	6338 035	OPEL			
44 34 144	OPEL	640972	SAAB			
44 34 190	OPEL	90 536 262	GM			
44 49 134	OPEL	90 536 262	VAUXHALL			
44 49 506	OPEL	90 536 501	GM			
411579.92D ▲	82 00 403 437	RENAULT	411576.87D ▲	90 536 501	VAUXHALL	
	82 00 703 140	RENAULT		93 181 245	GM	
	82 00 801 567	RENAULT		93 181 245	VAUXHALL	
	82 00 907 239	RENAULT				
	82 00 907 243	RENAULT		1338 004	OPEL	
	93 198 035	GM		9158251	GM	
	93 198 035	VAUXHALL				
	93 198 289	GM		069 121 113	AUDI	
	93 198 289	VAUXHALL		069 121 113	VOLKSWAGEN	
	93 198 317	GM		069 121 113 A	VOLKSWAGEN	
4116.87D1	93 198 317	VAUXHALL	272 246	VOLVO		
	93 198 576	GM	3 273 728	VOLVO		

# Vergleichsliste | Cross References

Wahler-Nr Wahler-ref. Réf. Wahler	Hersteller-Nr. Manufacturer's Ref. Réf. Constructeurs	Hersteller Manufacturer Réf. Constructeur	Wahler-Nr Wahler-ref. Réf. Wahler	Hersteller-Nr. Manufacturer's Ref. Réf. Constructeurs	Hersteller Manufacturer Réf. Constructeur
4117.80D	002 203 75 75	MERCEDES-BENZ	4147.80D	90 264 080	VAUXHALL
	002 203 80 75	MERCEDES-BENZ		90 354 822	DAEWOO
	615 200 13 15	MERCEDES-BENZ			
	616 200 04 15	MERCEDES-BENZ		1 612 191	FORD
411715.84D ▲	21200-AA140	SUBARU	1337 64	PEUGEOT	
	21200-AA160	SUBARU	1337 68	PEUGEOT	
	21200-AA220	SUBARU	1338 20	PEUGEOT	
	21200-AA230	SUBARU	1338 25	PEUGEOT	
	21210-AA140	SUBARU	6 182 480	FORD	
	21210-AA160	SUBARU	77 00 665 226	RENAULT	
411716.88D ▲	21200-AA150	SUBARU	77 00 697 157	RENAULT	
	21200-AA200	SUBARU	77 00 858 087	RENAULT	
	21210-AA120	SUBARU	77 00 862 200	RENAULT	
	21210-AA150	SUBARU	93 501 145	CITROËN	
411743.82D ▲	21200-AA170	SUBARU	93 501 386	CITROËN	
	21210-AA080	SUBARU	96 090 230 80	PEUGEOT	
4122.87D	1337 34	PEUGEOT	96 159 513	CITROËN	
	273 480	VOLVO	GTS 303	LANDROVER	
	77 00 657 955	RENAULT	T 069 7157	CHRYSLER	
	77 00 703 136	RENAULT	T 069 7157	JEEP	
	77 00 710 657	RENAULT	51.06402.0042	MAN	
	77 01 349 173	RENAULT	51.06402.0052	MAN	
	77 01 349 415	RENAULT	51.06402.0057	MAN	
	79 102 461 13	PEUGEOT	51.06402.0062	MAN	
4123.70	79 102 471 16	PEUGEOT	51.06402.0065	MAN	
	7910247116	LANCIA	51.06402.0068	MAN	
	076 121 113 A	VOLKSWAGEN	51.06402.0034	MAN	
	005 203 29 75	MERCEDES-BENZ	51.06402.0043	MAN	
	075 121 113 D	AUDI	51.06402.0044	MAN	
	075 121 113 D	SEAT	51.06402.0049	MAN	
4123.80D	075 121 113 D	VOLKSWAGEN	51.06402.0049	MAN	
	1 018 799	FORD	51.06402.0050	MAN	
	1 032 249	FORD	51.06402.0051	MAN	
	51.06402.0053		51.06402.0053	MAN	
	51.06402.0056		51.06402.0056	MAN	
	51.06402.0061		51.06402.0061	MAN	
4126.88	90048-33029-000	DAIHATSU	51.06402.0064	MAN	
	90916-03043	TOYOTA	51.06402.0067	MAN	
	90916-03062	TOYOTA	51.06402.0069	MAN	
4137.80D	004 203 39 75	MERCEDES-BENZ	51.06402.0058	MAN	
	004 203 40 75	MERCEDES-BENZ	51.06402.0060	MAN	
	116 200 03 15	MERCEDES-BENZ	51.06402.0063	MAN	
4144.82D	13 38 059	OPEL	51.06402.0066	MAN	
	13 38 062	OPEL	44 00 106	OPEL	
	90 410 665	GM	482 6602	FIAT	
	90 443 473	GM	50 00 816 924	RENAULT	
4144.92D	13 38 049	OPEL	9 108 106	GM	
	13 38 049	VAUXHALL	9 108 106	VAUXHALL	
	13 38 054	OPEL	730 3174	FIAT	
	90 232 012	GM	730 3615	FIAT	
			730 3615	IVECO	
			471 6264	IVECO	

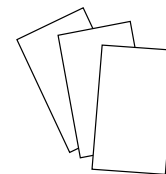

Wahler-Nr Wahler-ref. Réf. Wahler	Hersteller-Nr. Manufacturer's Ref. Réf. Constructeurs	Hersteller Manufacturer Réf. Constructeur	Wahler-Nr Wahler-ref. Réf. Wahler	Hersteller-Nr. Manufacturer's Ref. Réf. Constructeurs	Hersteller Manufacturer Réf. Constructeur
	480 7492	IVECO		9842 4854	IVECO
	483 1783	IVECO		9843 3497	IVECO
4154.82D	75 17 345	SAAB	4166.79D	480 4321	IVECO
	88 17 538	SAAB		9843 2310	IVECO
4154.88D	30 57 7561	SAAB	4168.92D	9846 7516	IVECO
	88 17 298	SAAB		13 38 060	OPEL
	88 22 025	SAAB	4174.79D	13 38 060	VAUXHALL
	91 66 687	SAAB		90 352 677	GM
	91 94 101	SAAB		45 00 823	OPEL
	91 94 242	SAAB		477 0246	IVECO
4155.87D	025 121 113 D	AUDI		482 3211	IVECO
	025 121 113 D	VOLKSWAGEN		483 7166	IVECO
	025 121 113 E	AUDI		77 01 042 512	RENAULT
	025 121 113 E	VOLKSWAGEN		809 6735	IVECO
	025 121 113 F	AUDI		9 161 123	GM
	025 121 113 F	VOLKSWAGEN		91 61 123	VAUXHALL
4158.80D	04778 975	CHRYSLER	4174.82D	9846 3637	FIAT
	13 38 466	OPEL		9846 3637	IVECO
	13 38 466	VAUXHALL		1338 90	CITROËN
	3 901 2004 F	VM		1338 90	PEUGEOT
	4778 975	CHRYSLER	4175.92D	5 0032 9622	FIAT
	7 072 643	FORD		50 032 9622	IVECO
	91 153 670	GM		13 38 067	OPEL
	91 153 670	VAUXHALL		13 38 067	VAUXHALL
	GTS 287	ROVER		13 38 084	OPEL
	PEL 10009 EVA	ROVER		13 38 084	VAUXHALL
	RTC 6673	LANDROVER		24 420 652	GM
	6051 6212	ALFA ROMEO		45 03 017	SAAB
4160.83D				46 23 815	SAAB
4161.83	928.106.129.06	PORSCHE	4176.80D	90 410 897	GM
	928.106.129.16	PORSCHE		90 502 201	GM
	928.106.129.17	PORSCHE		003 203 98 75	MERCEDES-BENZ
	6131 6592	IVECO		601 200 01 15	MERCEDES-BENZ
4162.79D	6131 8373	IVECO		602 200 00 15	MERCEDES-BENZ
	9849 2868	IVECO		603 200 00 15	MERCEDES-BENZ
4163.74D	9849 2873	IVECO	4176.85D	606 203 01 75	MERCEDES-BENZ
	9842 0718	IVECO		004 203 09 75	MERCEDES-BENZ
4163.79D	9846 7517	IVECO		0820117806	MULTICAR
	13 38 050	OPEL		601 200 00 15	MERCEDES-BENZ
	13 38 057	OPEL		606 203 02 75	CHEVROLET
	13 38 057	VAUXHALL		606 203 02 75	DAEWOO
4164.92D	13 38 063	OPEL	4177.92D	606 203 02 75	MERCEDES-BENZ
	13 38 063	VAUXHALL		606 203 05 75	MERCEDES-BENZ
	90 220 435	GM		13 38 068	OPEL
	90 354 822	GM		13 38 068	VAUXHALL
	90 443 472	GM		90 411 948	CHEVROLET
	473 8169	IVECO		90 411 948	DAEWOO
4165.79D				90 411 948	GM
				90 411 948	VAUXHALL

# Vergleichsliste | Cross References

Wahler-Nr Wahler-ref. Réf. Wahler	Hersteller-Nr. Manufacturer's Ref. Réf. Constructeurs	Hersteller Manufacturer Réf. Constructeur	Wahler-Nr Wahler-ref. Réf. Wahler	Hersteller-Nr. Manufacturer's Ref. Réf. Constructeurs	Hersteller Manufacturer Réf. Constructeur
4177.92D	92 063 300	GM	4223.75D	1 431 979	SCANIA
	92 063 300	HOLDEN			
4178.92D	13 38 073	OPEL	4223.83D	1 358 995	SCANIA
	13 38 073	VAUXHALL		1 404 924	SCANIA
	90 412 901	GM		1 423 450	SCANIA
4180.82D	13 38 069	OPEL	4224.75D	1 458 198	SCANIA
	13 38 069	VAUXHALL			
	90 486 128	GM	4224.80D	1 347 594	SCANIA
	92 061 279	DAEWOO		1 404 925	SCANIA
4183.82D	13 38 080	OPEL	4231.80D	11 53 1 251 041	BMW
	90 501 699	GM		11 53 1 254 065	BMW
4183.92D	13 38 079	OPEL	4232.71	11 53 1 265 086	BMW
	13 38 079	VAUXHALL			
	90 501 081	GM	4232.80D	11 53 1 264 668	BMW
4188.92D	13 38 087	OPEL		11 53 1 265 085	BMW
	90 529 846	GM	4233.84D	003 203 82 75	MERCEDES-BENZ
	90 529 846	VAUXHALL		116 200 02 15	MERCEDES-BENZ
4189.87D	48 11 586	OPEL	4235.71D	11 53 1 466 174	BMW
	92 062 728	CHEVROLET			
	92 062 728	DAEWOO	4235.80D	11 53 1 710 953	BMW
	92 067 408	CHEVROLET		11 53 1 713 040	BMW
	92 067 408	DAEWOO	4236.88D	11 53 1 721 002	BMW
4193.92D	47 72 190	SAAB		11 53 1 721 003	BMW
	9 543 786	GM		11 53 7 511 580	BMW
4194.92D	13 38 478	OPEL	4236.92D	11 53 1 733 803	BMW
	92 063 300	GM		11 53 7 511 083	BMW
4198.92D	13 38 100	OPEL	4237.80D	11 53 1 727 145	BMW
	90 572 899	GM		11 53 2 243 126	BMW
	90 572 899	VAUXHALL		11 53 2 244 151	BMW
				11 53 2 246 199	BMW
4201.92D	13 38 009	OPEL		13 38 076	OPEL
	13 38 097	OPEL		13 38 076	VAUXHALL
	24 435 781	GM		90 509 110	GM
	24 435 781	VAUXHALL		90 509 110	VAUXHALL
	90 573 926	GM	4237.88D	11 53 2 246 825	BMW
	90 573 926	VAUXHALL			
4206.90D	272 335	VOLVO	4238.92D	11 53 1 712 043	BMW
	9 125 406	VOLVO		11 53 1 743 528	BMW
				11 53 1 743 542	BMW
4207.92D	13 38 002	OPEL	4242.92D	13 38 003	OPEL
	9 128 786	GM		9 129 907	GM
	91 28 786	VAUXHALL		91 29 907	VAUXHALL
4208.92D	13 38 331	OPEL	4246.80D	4652 5581	FIAT
	90 573 326	GM			
	90 573 326	VAUXHALL	4247.80D	4646 6123	FIAT

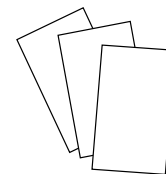

Wahler-Nr Wahler-ref. Réf. Wahler	Hersteller-Nr. Manufacturer's Ref. Réf. Constructeurs	Hersteller Manufacturer Réf. Constructeur	Wahler-Nr Wahler-ref. Réf. Wahler	Hersteller-Nr. Manufacturer's Ref. Réf. Constructeurs	Hersteller Manufacturer Réf. Constructeur	
4249.83D	996.106.013.54	PORSCHE	4256.92D50	6 058 444	FORD	
	996.106.013.55	PORSCHE		4264.84D	030 121 113	VOLKSWAGEN
	996.106.013.56	PORSCHE			030 121 113 B	AUDI
	996.106.013.57	PORSCHE			030 121 113 B	SEAT
	996.106.121.53	PORSCHE			030 121 113 B	VOLKSWAGEN
	996.106.125.52	PORSCHE				
4253.87D	032 121 113	SKODA	4264.87D		044 121 113	AUDI
	032 121 113	VOLKSWAGEN		044 121 113	SEAT	
	056 121 113	SKODA		044 121 113	SKODA	
	056 121 113	VOLKSWAGEN		044 121 113	VOLKSWAGEN	
	068 121 113 H	AUDI		056 121 113 D	AUDI	
	068 121 113 H	SEAT		056 121 113 D	SEAT	
	068 121 113 H	SKODA		056 121 113 D	SKODA	
	068 121 113 H	VOLKSWAGEN		056 121 113 D	VOLKSWAGEN	
4255.82D	08 966 483	GM	4269.78D	1 002 788	FORD	
	13 38 024	OPEL		1 031 881	FORD	
	13 38 024	VAUXHALL		1 096 699	FORD	
4255.87D	08 966 485	GM		4008540	MULTICAR	
	08 966 485	VAUXHALL		69015347	HAKO	
	13 38 033	OPEL		95VW 8575 AB	FORD	
	13 38 033	VAUXHALL		95VW 8575 AC	FORD	
4255.92D	13 38 038	OPEL		19300-PE0-013	HONDA	
	13 38 038	VAUXHALL		19300-PE0-024	HONDA	
	90 067 918	GM		19300-PLZ-004	HONDA	
	90 067 918	VAUXHALL	4270.88D	1 001 993	FORD	
4256.71	056 121 113 E	VOLKSWAGEN		1 663 819	FORD	
	068 121 113 A	VOLKSWAGEN		6 153 501	FORD	
4256.80D	056 121 113 A	AUDI		6 588 962	FORD	
	056 121 113 A	VOLKSWAGEN		6 866 389	FORD	
	4 N 6958	CATERILLAR		89FF 8575 AA	FORD	
	4 N 6959	CATERILLAR		89TM 8575 AA	FORD	
	9 L 9119	CATERILLAR		928M 8575 AE	FORD	
	9 L 9652	CATERILLAR		948M 8575 AA	FORD	
	9 N 5020	CATERILLAR		4272.90D	271 417	VOLVO
	9 N 5065	CATERILLAR	271 664		VOLVO	
	9 N 5121	CATERILLAR	74 31 397 947		RENAULT	
	9 N 5488	CATERILLAR	74 36 842 409		RENAULT	
4256.80D60	944.106.129.05	PORSCHE	74 39 180 811		RENAULT	
	4256.83D60	037 121 113	VOLKSWAGEN		9 180 811	VOLVO
		944.106.019.00	PORSCHE	4274.82D	077 121 113 C	AUDI
944.106.129.05		PORSCHE	077 121 113 C		VOLKSWAGEN	
4256.87D50	0 801 587	FORD	4274.87D	077 121 113	AUDI	
	6 100 372	FORD		077 121 113	SKODA	
	6 106 381	FORD		077 121 113	VOLKSWAGEN	
	6 124 378	FORD		077 121 113 B	AUDI	
	6 176 366	FORD		077 121 113 B	SKODA	
	84FF 8575 BA	FORD		077 121 113 B	VOLKSWAGEN	
	SE 021 032 221 B	SEAT		078 121 113	SKODA	
				078 121 113	VOLKSWAGEN	
				078 121 113 C	AUDI	

# Vergleichsliste | Cross References

Wahler-Nr Wahler-ref. Réf. Wahler	Hersteller-Nr. Manufacturer's Ref. Réf. Constructeurs	Hersteller Manufacturer Réf. Constructeur	Wahler-Nr Wahler-ref. Réf. Wahler	Hersteller-Nr. Manufacturer's Ref. Réf. Constructeurs	Hersteller Manufacturer Réf. Constructeur
4274.87D	078 121 113 C	SKODA	4368.87	63 38 050	OPEL
	078 121 113 C	VOLKSWAGEN		7173 9800	FIAT
	078 121 113 F	AUDI			
	078 121 113 F	SKODA		311.00.06.0065	STEYR
	078 121 113 F	VOLKSWAGEN			
	078 121 113 J	AUDI		81.06401.6002	MAN
	078 121 113 J	SKODA			
	078 121 113 J	VOLKSWAGEN		4414.87D	111 200 17 15
4274.92D	078 121 113 G	AUDI	4428.92D	111 203 10 75	MERCEDES-BENZ
	078 121 113 H	AUDI		63 38 004	OPEL
4275.87D	00A 121 113	VOLKSWAGEN	4430.87D	070 121 114	VOLKSWAGEN
	111 200 09 15	MERCEDES-BENZ	4431.105D		
	111 203 02 75	MERCEDES-BENZ		13 38 178	OPEL
	111 203 06 75	MERCEDES-BENZ		24 405 922	GM
	111 203 08 75	MERCEDES-BENZ		24 405 922	VAUXHALL
		55 577 072		GM	
4276.87D	110 200 03 15	DAEWOO		55 577 072	VAUXHALL
	111 200 03 15	MERCEDES-BENZ		63 38 018	OPEL
	111 203 03 75	MERCEDES-BENZ		7174 4389	FIAT
4278.80D	119 200 00 15	MERCEDES-BENZ		7177 0832	FIAT
	119 203 01 75	MERCEDES-BENZ		9 698 4104	CHEVROLET
4279.87D			4433.92D	13 38 017	OPEL
	111 200 08 15	MERCEDES-BENZ		24 447 862	GM
4280.80D	603 203 04 74	MERCEDES-BENZ	4434.80D	24 447 862	VAUXHALL
	605 203 00 75	MERCEDES-BENZ			
4280.85D	603 203 04 74	MERCEDES-BENZ	4436.80D	772 1399	FIAT
	604 203 00 75	MERCEDES-BENZ		4446.83D	777 0236
4281.87D				1338 23	CITROËN
	112 200 00 15	MERCEDES-BENZ		1338 23	PEUGEOT
	112 203 02 75	MERCEDES-BENZ		17570-86CA0	SUZUKI
4297.92D	5098 918 AA	CHRYSLER		17670-66G00	SUZUKI
				21215-13060-15	LADA
	13 38 015	OPEL		25511-29000	HYUNDAI
	24 420 728	GM		77 00 868 274	RENAULT
	24 420 728	VAUXHALL		77 01 038 494	RENAULT
4298.87D				96 160 901	CITROËN
	112 200 01 15	MERCEDES-BENZ		9616 0901 80	FIAT
4309.92D	112 203 03 75	MERCEDES-BENZ	4447.80D	9616 0901 80	LANCIA
	628 203 01 75	MERCEDES-BENZ		SU001-0223	TOYOTA
4326.97D				1338 19	PEUGEOT
	11 53 0 139 877	BMW		1338 72	CITROËN
	11 53 1 436 823	BMW		1338 72	PEUGEOT
	11 53 1 437 040	BMW		96 118 108	CITROËN
4337.105D	11 53 7 509 227	BMW	4447.85D	96 272 785 80	PEUGEOT
	11 53 7 510 959	BMW		1338 13	PEUGEOT
4351.79				1338 71	CITROËN
	114 470	VALTRA		1338 71	PEUGEOT
4357.92D	9 225 0 757 014 6	MWM		96 058 051	CITROËN
				96 272 814 80	PEUGEOT
	24 435 102	SAAB	4449.84D	77 00 260 959	RENAULT



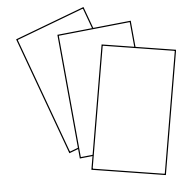

Wahler-Nr Wahler-ref. Réf. Wahler	Hersteller-Nr. Manufacturer's Ref. Réf. Constructeurs	Hersteller Manufacturer Réf. Constructeur	Wahler-Nr Wahler-ref. Réf. Wahler	Hersteller-Nr. Manufacturer's Ref. Réf. Constructeurs	Hersteller Manufacturer Réf. Constructeur	
4450.83D	1338 39	CITROËN	4490.87D	642 200 02 15	MERCEDES-BENZ	
	1338 39	PEUGEOT		642 200 20 15	MERCEDES-BENZ	
	96 160 902 80	PEUGEOT	4508.105D	11 53 7 502 779	BMW	
	9616 0902 80	FIAT		11 53 7 586 885	BMW	
4450.89D	1338 26	CITROËN	4516.70D	11 53 7 586 885	ROLLS-ROYCE	
	1338 26	PEUGEOT		11 53 1 731 486	BMW	
	96 108 092	CITROËN	4516.85D	11 53 1 710 056	BMW	
	96 108 092 80	PEUGEOT		11 53 1 720 033	BMW	
4455.80D	96 108 093 80	PEUGEOT	4517.87D	11 53 1 720 306	BMW	
	022 121 113	AUDI		11 53 1 729 720	BMW	
	022 121 113	VOLKSWAGEN		11 53 1 729 841	BMW	
4457.82D	955.106.113.00	PORSCHE	4519.95D	120 200 00 15	MERCEDES-BENZ	
	1 007 754	FORD		120 203 02 75	MERCEDES-BENZ	
	1 211 553	FORD	4520.75	11 53 1 702 279	BMW	
	1 303 374	FORD		1 395 856	SCANIA	
	1E05-15-171 A	MAZDA	4520.80D	6 052 5 010 005 0	MWM	
	96MM 8575 A1A	FORD		0303.191.04	NEOPLAN	
	96MM 8575 BD	FORD		2 832 814	SCANIA	
4459.92D	96MM 8575 BE	FORD	4529.70	283 281	SCANIA	
	12 992 692	GM		2871 591 M	KOMATSU	
	13 38 096	OPEL		550 275	SCANIA	
	13 38 096	VAUXHALL		609E060013	STEYR	
	63 38 028	OPEL		00 24 774 033	RENAULT	
	90 570 620	GM		4529.83D0	50 00 694 785	RENAULT
	90 570 620	VAUXHALL			154.0943.426	SAURER
4472.83D 4480.82D	005 203 59 75	MERCEDES-BENZ	4530.80	2872 578 M	KOMATSU	
	90916-03075	TOYOTA		738 0513	LIEBHERR	
	90916-03084	TOYOTA	4572.105D	07Z 121 111	VOLKSWAGEN	
	90916-03125	TOYOTA		149 620	VALTRA	
	90916-03129	TOYOTA	4588.75/1	9 229 8 757 004 6	MWM	
	90916-03133	TOYOTA		11 53 1 704 704	BMW	
	90916-03136	TOYOTA	4594.90D	50 10 295 225	RENAULT	
	90916-03140	TOYOTA		271990009-00	BUGATTI	
	90916-03144	LEXUS	4596.83D	27199003-00	BUGATTI	
	90916-03144	TOYOTA		005 203 17 75	MERCEDES-BENZ	
	90916-03145	LEXUS	4618.70	1 661 993	VOLVO	
	90916-03145	TOYOTA		222730	PEGASO	
	90916-A3001	TOYOTA	4618.82	770662	PEGASO	
90916-A3002	TOYOTA	005 203 18 75		MERCEDES-BENZ		
90916-A3003	TOYOTA	4619.75	075 0562	DAF		
4483.82D	1 306 004		FORD	4619.80		
	1 712 228	FORD				
	30 711 624	VOLVO				
	4M5G 8575 ZA	FORD				
	4M5G 8575 ZB	FORD				
4488.80D0	07K 121 113 B	VOLKSWAGEN				
	4489.90D	3071 3572	VOLVO			

# Vergleichsliste | Cross References

Wahler-Nr Wahler-ref. Réf. Wahler	Hersteller-Nr. Manufacturer's Ref. Réf. Constructeurs	Hersteller Manufacturer Réf. Constructeur	Wahler-Nr Wahler-ref. Réf. Wahler	Hersteller-Nr. Manufacturer's Ref. Réf. Constructeurs	Hersteller Manufacturer Réf. Constructeur
4619.80	11 53 1 312 288	BMW	4639.82D	17670-77E10	SUZUKI
	11 53 1 315 063	BMW		17670-77E11	SUZUKI
	295 024	DAF		1A51-15-171	MAZDA
	750 562	DAF		3 396 924	FORD
4619.82	1 544 683	VOLVO	3 599 763	FORD	
	50 01 855 520	RENAULT	3 893 570	FORD	
	8 149 182	VOLVO	3 902 514	FORD	
4619.86	005 203 19 75	MERCEDES-BENZ	4 176 181	FORD	
	1 665 694	VOLVO	4 188 498	FORD	
	50 10 447 161	RENAULT	8AGX-15-171	MAZDA	
	50 10 553 100	RENAULT	F42Z 8575 BA	FORD	
	50 409 6443	IVECO	FS05-15-171	MAZDA	
	8 149 186	VOLVO	KL01 15 171 A	FORD	
	8929878	DETROIT DIESEL	KL01-15-171	MAZDA	
	9943 1512	IVECO	KL01-15-171 A	MAZDA	
4621.80D	11 53 1 318 274	BMW	XM34 8575 AA	FORD	
			XM34 8575 AB	FORD	
4622.82D0	9849 8322	IVECO	06C 121 111 C	VOLKSWAGEN	
4630.87D ▲	5175583AB	JEEP	06C 121 111 D	VOLKSWAGEN	
	642 200 03 15	MERCEDES-BENZ	06C 121 111 E	VOLKSWAGEN	
4634.76	21200-77A00	NISSAN	3063 7217	VOLVO	
	21200-77A60	NISSAN	3065 0022	VOLVO	
	21200-77A61	NISSAN	3077 7475	VOLVO	
	21200-77A63	NISSAN	3129 3699	VOLVO	
4637.76D	MD 164541	MITSUBISHI	4817.90D	3063 7216	VOLVO
	MD 170031	MITSUBISHI	3065 0023	VOLVO	
	MD 317015	MITSUBISHI	3121 9205	VOLVO	
	MD 345617	MITSUBISHI	4818.90D	3065 0469	VOLVO
	ME 190303	MITSUBISHI	3077 7476	VOLVO	
	ME 191593	MITSUBISHI	3129 3698	VOLVO	
	ME 200262	MITSUBISHI	4820.87D	03G 121 111 A	AUDI
4637.82D	30874021	VOLVO	03G 121 111 A	SEAT	
	30875350	VOLVO	03G 121 111 A	SKODA	
	MD 158570	MITSUBISHI	03G 121 111 A	VOLKSWAGEN	
	MD 165630	MITSUBISHI	03G 121 113 A	AUDI	
	MD 175746	MITSUBISHI	03G 121 113 A	SEAT	
	MD 310106	MITSUBISHI	03G 121 113 A	SKODA	
	MD 315301	MITSUBISHI	03G 121 113 A	VOLKSWAGEN	
	MD 335170	MITSUBISHI	4821.89D	1338 21	CITROËN
	MD 337408	MITSUBISHI	1338 21	PEUGEOT	
	MD 338234	MITSUBISHI	1338 C8	PEUGEOT	
	MD 360320	MITSUBISHI	21200-6F900	NISSAN	
			21200-6F901	NISSAN	
4638.76D	MD 997605	MITSUBISHI	96 006 231	CITROËN	
			GTS 299	ROVER	
4638.82D	MD 015299	MITSUBISHI	PEL 10019 EVA	ROVER	
	MD 094120	MITSUBISHI	4825.98D	1 345 512	FORD
	MD 997224	MITSUBISHI	1 351 716	FORD	
	MD 997606	MITSUBISHI	4M5G 6L721 GA	FORD	
	ME 999295	MITSUBISHI	4M5G 6L721 GB	FORD	

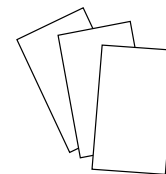

Wahler-Nr Wahler-ref. Réf. Wahler	Hersteller-Nr. Manufacturer's Ref. Réf. Constructeurs	Hersteller Manufacturer Réf. Constructeur	Wahler-Nr Wahler-ref. Réf. Wahler	Hersteller-Nr. Manufacturer's Ref. Réf. Constructeurs	Hersteller Manufacturer Réf. Constructeur			
4829.100D ▲	272 200 06 15	MERCEDES-BENZ		6 077 896	FORD			
	273 200 01 15	MERCEDES-BENZ		6 077 897	FORD			
	273 200 04 15	MERCEDES-BENZ		6 077 898	FORD			
4832.87D ▲	642 200 07 15	MERCEDES-BENZ		6 077 985	FORD			
				823 959 481 G	AUDI			
4833.100D	272 200 05 15 273 200 02 15 6801 3949 AA	MERCEDES-BENZ MERCEDES-BENZ CHRYSLER		823 959 481 G	SEAT			
				823 959 481 G	SKODA			
				823 959 481 G	VOLKSWAGEN			
4834.100D	272 200 00 15 272 200 01 15 272 200 04 15	MERCEDES-BENZ MERCEDES-BENZ MERCEDES-BENZ		823 959 481 H	SKODA			
				823 959 481 H	VOLKSWAGEN			
				823 959 481 K	SKODA			
4835.87D	642 200 02 15 642 200 04 15	MERCEDES-BENZ MERCEDES-BENZ		823 959 481 K	VOLKSWAGEN			
				90 108 636	GM			
6010.75D	113 095 075 217.87.71 84247900	SKODA STEYR INTER. HARV. IHC		90 108 636	VAUXHALL			
				95 26 518	SAAB			
6010.88D	115 095 070 547 4546 5474546 5474546 6 144 361 85 47 572	SKODA FIAT CITROËN PEUGEOT FORD SAAB		6016.92	595 1985	FIAT		
				6017.95D	595 1987	FIAT		
				6010.92D	113 095 090 2828 6103 411 4572 423 5333 423 5533 424 0878 426 3597 823 959 481 823 959 481 823 959 481 823 959 481 A 823 959 481 A 823 959 481 A 823 959 481 A 823 959 481 F 823 959 481 F 823 959 481 F 823 959 481 L 823 959 481 L 823 959 481 L 85 69 23 944.606.481.00	SKODA FIAT FIAT FIAT FIAT FIAT FIAT AUDI SEAT VOLKSWAGEN AUDI SEAT VOLKSWAGEN AUDI SEAT VOLKSWAGEN AUDI SEAT VOLKSWAGEN SEAT AUDI SEAT VOLKSWAGEN SEAT SEAT VOLKSWAGEN AUDI SEAT VOLKSWAGEN SAAB PORSCH	191 959 481 A	AUDI
							191 959 481 A	SEAT
							191 959 481 A	VOLKSWAGEN
							191 959 481 C	AUDI
191 959 481 C	SEAT							
191 959 481 C	VOLKSWAGEN							
6010.95D	13 41 002 13 41 002 426 3997 434 0878 6 072 016 6 077 895	OPEL VAUXHALL AUTOBIANCHI FIAT FORD FORD		251 959 481	AUDI			
				251 959 481	SEAT			
				251 959 481	VOLKSWAGEN			
				321 959 481 A	AUDI			
				321 959 481 A	SEAT			
				321 959 481 A	VOLKSWAGEN			
				321 959 481 C	AUDI			
			321 959 481 C	SEAT				
			321 959 481 C	VOLKSWAGEN				
			321 959 481 D	AUDI				
			321 959 481 D	SEAT				
			321 959 481 D	VOLKSWAGEN				
6020.92D	823 959 481 823 959 481 823 959 481 823 959 481 A 823 959 481 A 823 959 481 A 823 959 481 A 823 959 481 F 823 959 481 F 823 959 481 F 823 959 481 L 823 959 481 L 823 959 481 L 85 69 23 944.606.481.00	AUDI SEAT VOLKSWAGEN AUDI SEAT VOLKSWAGEN AUDI SEAT VOLKSWAGEN AUDI SEAT VOLKSWAGEN SAAB PORSCH	441 044 330 186	SKODA				
			6U0 959 481 A	AUDI				
			6U0 959 481 A	SEAT				
			6U0 959 481 A	VOLKSWAGEN				
			SE 021 952 600 A	SEAT				
			6020.95D	191 959 481 B	AUDI			
6024.95D	13 41 002 13 41 002 426 3997 434 0878 6 072 016 6 077 895	OPEL VAUXHALL AUTOBIANCHI FIAT FORD FORD	191 959 481 B	SEAT				
			191 959 481 B	VOLKSWAGEN				
			321 959 481 B	VOLKSWAGEN				
			321 959 481 E	AUDI				
			321 959 481 E	VOLKSWAGEN				
			321 959 481 G	VOLKSWAGEN				
6010.95D	13 41 002 13 41 002 426 3997 434 0878 6 072 016 6 077 895	OPEL VAUXHALL AUTOBIANCHI FIAT FORD FORD	811 959 481	AUDI				
			811 959 481	VOLKSWAGEN				
			893 959 481	AUDI				
			893 959 481	VOLKSWAGEN				

## Vergleichsliste | Cross References

Wahler-Nr Wahler-ref. Réf. Wahler	Hersteller-Nr. Manufacturer's Ref. Réf. Constructeurs	Hersteller Manufacturer Réf. Constructeur
---	---	---

6031.100D	13 41 011	OPEL
	13 41 011	VAUXHALL
	90 242 277	GM
	90 242 277	VAUXHALL
6031.105D	13 41 017	OPEL
	13 41 017	VAUXHALL
	90 277 288	GM
	90 277 288	VAUXHALL
6031.88D	1264 50	PEUGEOT
	13 0707 7080	FIAT
	13 41 028	OPEL
	13 41 028	VAUXHALL
	90 357 303	GM
	90 357 303	VAUXHALL
6031.92D	1264 32	PEUGEOT
	1264 50	PEUGEOT
	599 2746	FIAT
	6056 4101	FIAT
	6080 8223	FIAT
	774 8867	FIAT
	8242 0013	FIAT
	8243 6410	FIAT
	8246 5533	FIAT
	8247 7919	FIAT
907 0701	FIAT	
6031.97D	4652 0219	FIAT

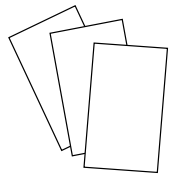

Wahler-Nr Wahler-ref. Réf. Wahler	Dichtung Gasket Joint	Wahler-Nr Wahler-ref. Réf. Wahler	Dichtung Gasket Joint	Wahler-Nr Wahler-ref. Réf. Wahler	Dichtung Gasket Joint
100456D5	100456	3119.88D5	100601	4038.71D	104224
102543D5	102543		100607	4038.76D	104224
110156D5	110156	3119.92D3	100599	4038.81D	104224
110392D5	110392		100600	4049.80D	002085
115600D5	115600	3136.82D50	002154	4049.80D1	002479
117385D5	117385		105433	4049.87D	002085
3004.82D1	002149	3136.88D50	002154	4064.75D	002085
3004.88D1	002149		105433	4078.65D	002085
3004.92D1	002149	3141.87D	002138	4078.71D	002085
3017.87D2	003187	3142.90D	102642	4078.75D	002085
3017.87D50	002137	3143.87D	102725	4078.79D	002085
	002150	3145.79D	108476	4078.87D	002085
3017.92D2	003187	3146.90D	102642	4078.92D	002085
3017.92D50	002137	3151.87D	003062	4083.83D50	002892
	002150	3159.82D	003594		002922
3021.88D50	002153	3163.88D	104360	4088.80D	002085
	002163	3164.88	104360	4088.87D	002085
	002164	3166.89D	105317	4089.71D	003192
	002523	3167.83D	102725	4089.82D	003192
3021.92D50	002153	3169.79D	119164	4089.87D	003192
	002163	3171.82D	119081	4089.92D	003192
	002164	3174.89D	105571	4091.82D	116692
	002523	3300.80D	104361		116693
3023.87D	002160	3301.80D	104361	410007.87D	003588
3033.78D	120675	3302.80D	104361	410048.88D	109953
3033.84D	120675	3355.80D	003587	410049.88D	109944
3044.90D1	100595	3356.80D	003590	410055.87D	114270
3054.87D50	002143	3360.87D	003588		114365
	002153	3361.87D	003588	410058.84D	114419
3054.92D50	002143	3373.80D	003587	410075.79D	119164
	002153	3383.87	108485	410081.79D	119164
3091.92D	002137	3431.80D	104361	410090.88D	112151
3100.88D	102511	3457.90D	114432	410131.88D	102511
3100.92D	102511		114433	410171.87D	104738
3103.79	003602	3466.89D	105414	410174.92D	104738
3105.87D	003062	3467.85D	114595	410178.82D	114229
3109.82D	003592	3469.91D	105414	410181.82D	115702
3109.87D	003592	3470.89D50	105434	410183.82D	118938
3116.82D	120392		105435		118939
3116.89D	120392	3472.87D	002138	410183.88D	118938
3118.82D1	100596	3477.88D	115864		118939
	100597	3478.82D	115422	410201.80D	115864
	100606	3481.88D	104360	410224.78D	115423
3118.88D1	100596	3484.87D	108485	410224.82D	115423
	100597	3485.87D	108485	410228.82D	100596
	100606	3498.88D	100599	410230.78D	116903
3118.92D1	100596	3499.82D	100599	410262.91D	114731
	100597	3499.88D	100599	410263.91D	114731
	100606	4006.82D	002138	410289.81D	120389
3119.82D3	100599	4007.80D	110991	4103.82D	115422
	100600	4008.74D	003594	410348.82D	117136
3119.82D4	100605	4008.79D	003594		118913
3119.82D5	100601	4022.82D	003192	410352.82D	100599
	100607	4022.82D1	003595	410352.88D	100599
3119.88D3	100599	4022.88D	003192	410389.103D	116490
	100600	4022.92D	003192		118342
3119.88D4	100605	4033.82D	002144	410475.80D	102725
		4038.65D	104224	410475.87D	102725



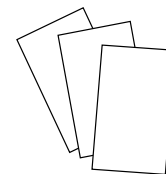

Wahler-Nr Wahler-ref. Réf. Wahler	Dichtung Gasket Joint	Wahler-Nr Wahler-ref. Réf. Wahler	Dichtung Gasket Joint	Wahler-Nr Wahler-ref. Réf. Wahler	Dichtung Gasket Joint
410488.88D	003192	4115.92D	002900	4201.92D	104892
4105.65D	002892	411545.82D	115864	4206.90D	100928
4105.71D	002892	4116.87D1	102081		101313
4105.75D	002892	4117.80D	002085	4207.92D	104892
4105.79D	002892	411715.84D	116903	4208.92D	102543
4105.83D	002892	411716.88D	116903	4223.75D	122689
410513.88D	003123	411743.82D	116903	4223.83D	122689
410514.88D	003123	4122.87D	002898	4224.75D	122690
410515.88D	003123	4123.80D	102081	4224.80D	122690
410516.88D	003123	4132.74D	002817	4231.71D	002140
410537.92D	002138	4137.71D	002085	4231.80D	002140
410590.88D	003123	4137.80D	002085	4231.84D	002140
410608.86D	118996	4144.82D	101973	4232.80D	002085
	119078	4144.92D	101973	4233.80D	002430
	119080	4147.80D	002898	4233.84D	002430
	120213	4150.71D50	002892	4235.71D	002085
	4619.86		106244	4235.75D	002085
410692.71D	119879	4150.79D50	002892	4235.80D	002085
	119880		106244	4236.88D	002085
410758.83D	120299	4150.83D50	002892	4236.92D	002085
	4596.83		106244	4237.80D	002085
410763.82D	003896	4151.76D	120392	4237.88D	002085
	120329	4151.79D	120392	4238.92D	002085
	120330	4152.79D	002817	4242.92D	102543
	4622.82D0	4154.82D	003192	4246.80D	104361
410765.90D	120222	4154.88D	003192	4247.80D	104361
410806.88D	120763	4155.87D	102081	4249.71D	106281
410808.88D	120763	4158.80D	002817	4249.83D	106281
410828.82D	121904	4160.83D	003052	4253.87D	002138
	122345	4162.79D	120392	4255.82D	003561
410828.86D	121904	4163.74D	002817	4255.87D	003561
	122345	4163.79D	102226	4255.92D	003561
410845.87D	120086	4164.92D	101973	4256.80D	002138
410845.92D	120086	4165.79D	102226	4256.80D60	000232
410871.80D	112151	4166.79D	002817		003602
	127334		102226	4256.83D60	003602
410937.82D	119081	4168.92D	101973		120392
410989.80D	124401	4174.79D	003595	4256.87D50	002138
410989.87D	124401		120392		002147
410994.88D	003123	4174.82D	003595		002148
411004.80D	122690		120392	4256.92D50	002138
411045.82D	121908	4174.88D	003595		002147
411133.80D	123872		120392		002148
	123873	4175.92D	100008	4264.84D	002138
	4619.80	4176.70D	002584	4264.87D	002138
411135.83D	123747	4176.75D	002584	4269.78D	115423
	123748	4176.80D	002584	4270.88D	102511
	411089.83D	4176.85D	002584	4272.90D	003192
411135.87D	123747	4177.92D	100007	4274.82D	102081
	123748	4178.92D	101973	4274.87D	102081
	411089.87D	4180.82D	101973	4274.92D	102081
411186.87D	120086	4183.82D	100007	4275.87D	002085
	127069	4183.92D	100007	4276.87D	002085
	127070	4188.92D	104892	4278.80D	102084
411187.87D	120086	4189.87D	100007	4279.87D	002085
	127069	4193.92D	104892	4280.80D	003650
	127070	4194.92D	100007	4280.85D	003650
4112.79D	002892	4198.92D	104892	4281.87D	003658

Wahler-Nr Wahler-ref. Réf. Wahler	Dichtung Gasket Joint	Wahler-Nr Wahler-ref. Réf. Wahler	Dichtung Gasket Joint	Wahler-Nr Wahler-ref. Réf. Wahler	Dichtung Gasket Joint
4297.92D	104892	6010.88D	002358	7187D	101561
4298.87D	003658	6010.92D	002358		115600
4309.92D	101642	6010.95D	002358	7188D	115599
4357.92D	104385	6017.85D	002358	7206D	101541
4414.87D	002085	6017.95D	002358		117943
4428.92D	104892	6020.92D	002358		117944
4430.87D	115028	6020.95D	002358	7211D	115599
4431.105D	104385	6024.95D	002358	7220D	117943
4433.92D	104892	6031.100D	002358		117944
4434.80D	104361	6031.105D	002358	7223D	110156
4436.80D	104361	6031.88D	002358	7234D	115618
4446.83D	105410	6031.92D	002358		115619
4447.80D	002898	6031.97D	002358	7241D	100456
4447.85D	002898	60347D	123800		115600
4449.84D	002898		123801	7256D	120620
4450.83D	105410	6035.92D	002358	7268D	111127
4450.89D	105410	60364D	117385		117420
4455.80D	102081	6037.81D	002358		117421
4457.82D	105686	6037.87D	002358	7271D	103995
	106503	6037.95D	002358		115600
4459.92D	102322	60375D	115586	7283D	100456
4472.83D	002892	6039.95D	002358	7293D	100456
4480.82D	114229	60409D	115600	7294D	100456
4483.82D	106307		117385		115600
	106503	60415D	123800		117385
4489.90D	108431	60579D	126105	7301D	117385
4490.87D	117217	60595D	101541	7327D	110156
4508.105D	100532		102241		115600
4516.70D	104887		117943		117385
4516.85D	104887	60633D	115600	7350D	118533
4517.87D	002085		117385	7353D	103046
4519.95D	104887	60700D	115600	7371D	110156
4520.80D	104470		117385		115600
4572.105D	120626	60702D	115600	7372D	110156
4594.90D	003562		117385		115600
4596.83D	120298	60777D	115600D5		117385
4621.80D	101216		117385	7375D	115593
4630.87D	117217	6087.87D	002358	7389D	103046
4638.76D	111209	61010D	115600	7396D	121743
4638.82D	111209	61384D	117385		121747
4814.92D	103394	665104D	115600D5	7451D	110156
4816.90D	114704	665574D	100456		117385
4817.90D	114704		102543	7496D	102543
4818.90D	114704		110156		110156
4820.87D	002138		110392		115600
4821.89D	109319		115600	7497D	118533
4829.100D	110657		117385		118534
4832.87D	114270	710023D	103046	7504D	110221
	117217	710073D	110221	7523D	118530
4833.100D	110657	710095D	106306	7527D	106306
4834.100D	110657	710327D	103386	7529D	110392
	111203	710476D	123589	7545D	108551
4835.87D	117217	710559D	127104	7556D	108056
6010.100D	002358	710571D	110392	7557D	108056
6010.70D	002358	710572D	110392	7574D	117948
6010.75D	002358	710574D	115600		126163
6010.82D	002358		127082	7610D	123590
6010.85D	002358	7159D	115586	7625D	103046

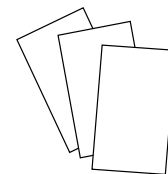

<b>Wahler-Nr Wahler-ref. Réf. Wahler</b>	<b>Dichtung Gasket Joint</b>
--	--------------------------------------

<b>7631D</b>	118493 118532 118533
--------------	----------------------------

<b>7645D</b>	106306
--------------	--------

<b>7649D</b>	101953 115600
--------------	------------------

<b>7650D</b>	101953 117385
--------------	------------------

Wahler-Nr Wahler-ref. Réf. Wahler	Dichtung Gasket Joint	Wahler-Nr Wahler-ref. Réf. Wahler	Dichtung Gasket Joint
003602	120392	4565.80	4565.80/2
100928	120389	4570.80	4684.80/1
104360	003123	4596.83	4596.83D
115600	115600D5	4622.82	4622.82D0
117385	117385D5	4663.80/1	410864.79D0
2383.75	2391.75	4665.80/1	4684.80/1
3000.70	3000.75	4684.70/1	410864.71D0
3004.88	3004.88D1	4684.80/1	410864.79D0
3021.88	3021.88D50	4684.83/1	410864.83D0
3029.72	3029.78	4689.97	4689.97D0
3033.78	3033.78D	4689.97D0	410086.97D0
3033.84	3033.84D	6035.92	6035.92D
3044.90	3044.90D1		
3053.72	3053.75		
3053.78	3053.75		
3054.92D	3054.92D50		
3118.82	3118.82D1		
3118.88	3118.88D1		
3118.92	3118.92D1		
3119.92	3119.92D3		
3347.80	3343.80D		
3391.92D	4459.92D		
4069.75/1	4083.79		
4083.71	4105.71D		
4083.71D1	4105.71D		
4083.79	4105.79D		
4083.83	4105.83D		
4089.87	4089.87D		
4089.92	4089.92D		
4091.82	4091.82D		
410044.82D	410231.82D		
410069.82D	410937.82D		
410176.82	410176.82D0		
410176.88	410176.88D0		
4103.82	4103.82D		
410695.105D	411059.105D		
4112.79D	4150.79D50		
4116.87D	4116.87D1		
4160.83	4160.83D		
4165.79	4165.79D		
4166.79	4166.79D		
4238.92D	4236.92D		
4269.78	4269.78D		
4340.80	4341.80		
4371.80	4351.79		
4378.80	4341.80		
4379.80	4351.79		
4417.81D	410289.81D		
4453.87D	410171.87D		
4488.80	4488.80D0		
4523.75	4520.75		
4523.80	4520.80D		
4546.80	4565.80		
4546.80	4565.80/2		
4547.70	4565.70		
4547.80	4565.80		
4547.80	4565.80/2		

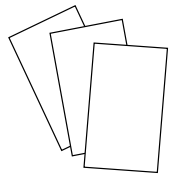

# Einbaumaße Assembly dimensions

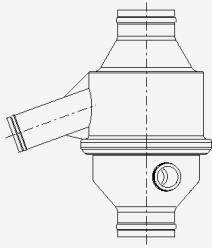

Typ  
2389

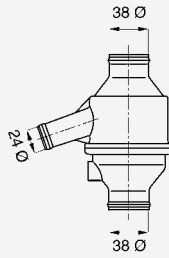

Typ  
2391  
2394

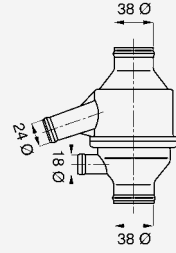

Typ 2393

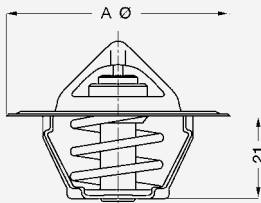

Typ A  
3000 54 mit Entlüftungskerbe  
3021 48  
3044 44  
3136 53,5  
3141 54 ohne Entlüftungskerbe  
3167 54 gummibeschichtete Ventilplatte

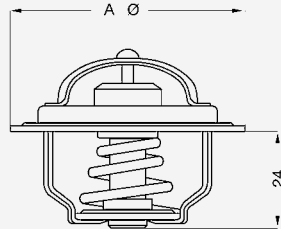

Typ A  
3004 54 mit Entlüftungsventil  
3032 60 mit Entlüftungsventil  
3061 57 mit Entlüftungsventil  
3063 53,5 mit Entlüftungskerbe

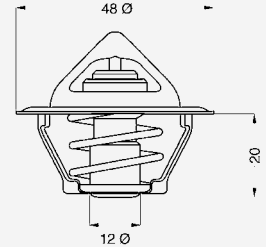

Typ 3017 mit Entlüftungskerbe  
3091 mit Entlüftungsventil und gummibeschichteter Ventilplatte  
3082 gummibeschichtete Ventilplatte

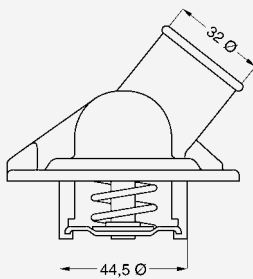

Typ 3022

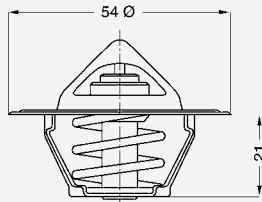

Typ 3023 mit Entlüftungskerbe

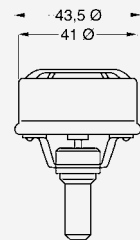

Typ 3029

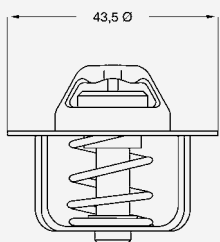

Typ 3033

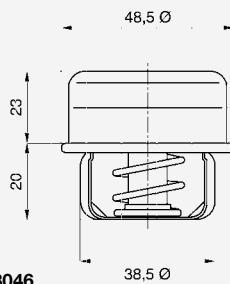

Typ 3046

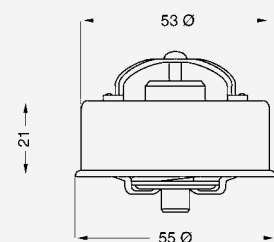

Typ 3053



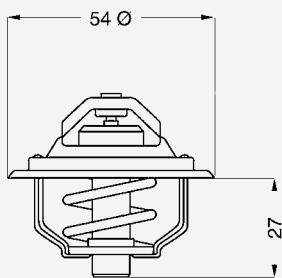
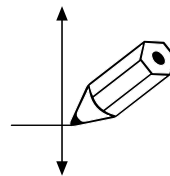

**Typ 3054**

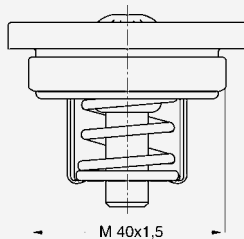

**Typ 3067**

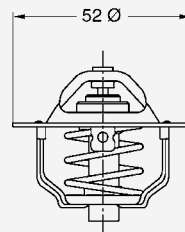

**Typ 3100**

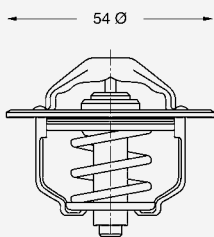

**Typ 3103** mit Entlüftungsventil

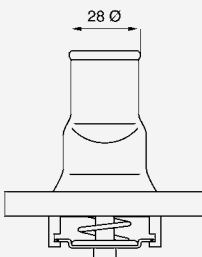

**Typ 3105**

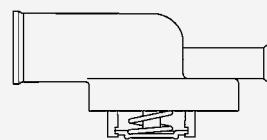

**Typ 3109**

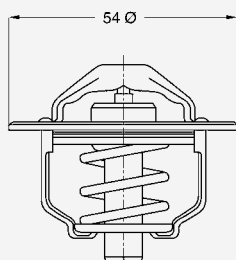

**Typ 3116** mit Entlüftungsventil

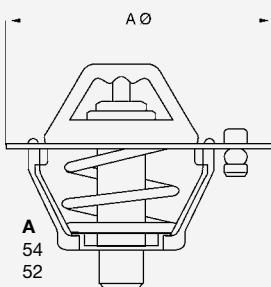

**Typ 3118** 54  
**Typ 3119** 52  
**Typ 3499** 52

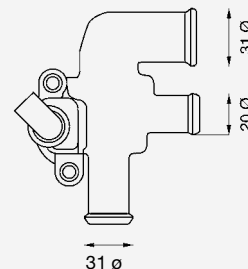

**Typ 3142**

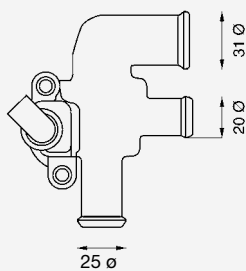

**Typ 3146**

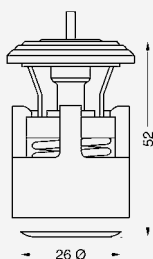

**Typ 3143**

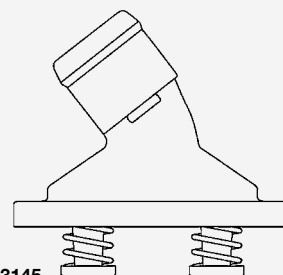

**Typ 3145**

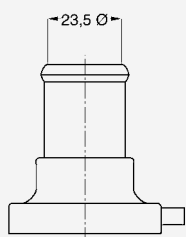

**Typ 3151**

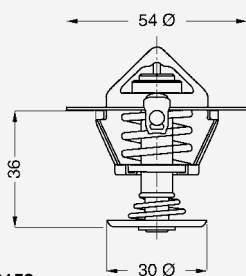

**Typ 3159**

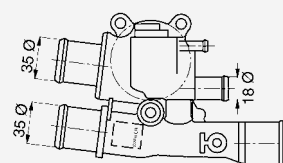

**Typ 3163** mit M 12 x 1,5  
**Typ 3481** mit M 12 x 1,5 / M 16 x 1,5

# Einbaumaße Assembly dimensions

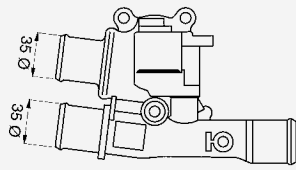

Typ 3164

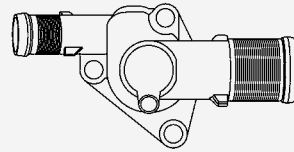

Typ 3166

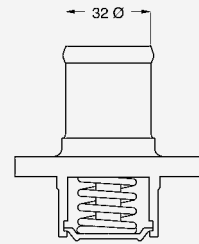

Typ 3174

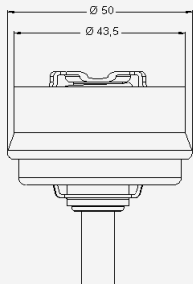

Typ 3187

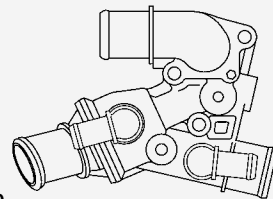

Typ  
3300  
4434 mit M22 x 1,5  
4436 mit M16 x 1,5

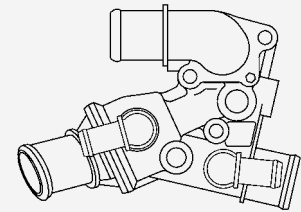

Typ  
3301 mit 2 x M16 x 1,5  
3302 mit 1 x M16 x 1,5

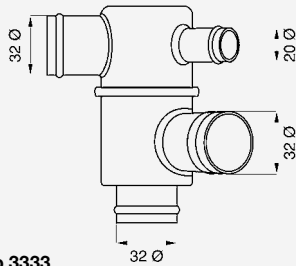

Typ 3333

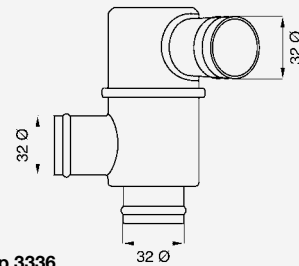

Typ 3336

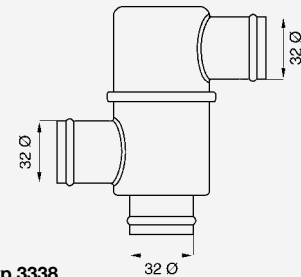

Typ 3338

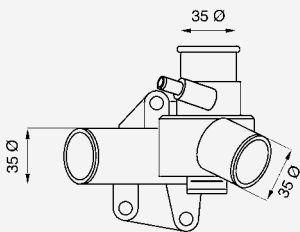

Typ  
3343 21 Ø  
3347 16,8 Ø

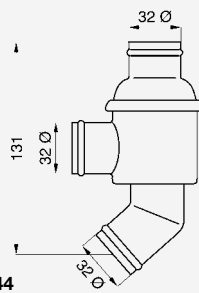

Typ 3344

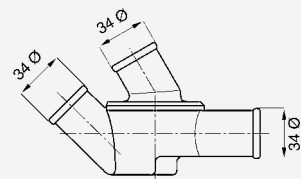

Typ 3345

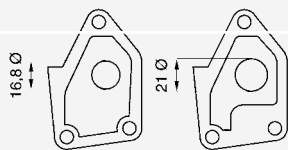

Typ  
3343 21 Ø  
3347 16,8 Ø

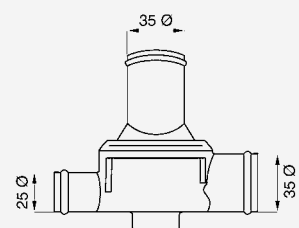

Typ 3352

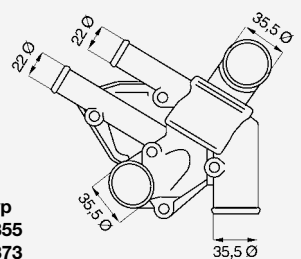

Typ  
3355  
3373  
3378

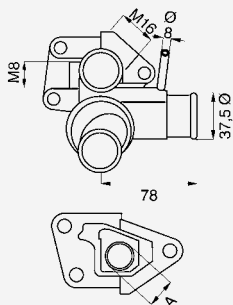
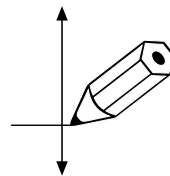

**Typ A**  
**3356** 21, mit M 16, ohne M8, mit Ø 8  
**3364** 23, ohne M 16, ohne M8, ohne Ø 8  
**3366** 21, mit M 16, mit M8, mit Ø 8

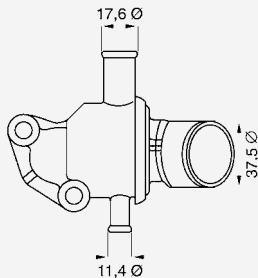

**Typ 3361**  
**3360** Stützen am Deckel  
um 90° gedreht

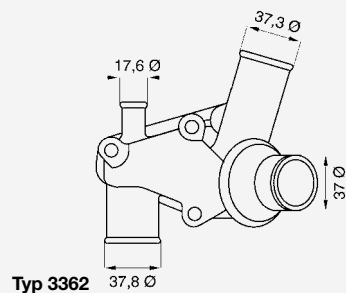

**Typ 3362**

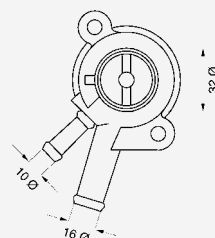

**Typ 3383** mit Ø 10, 31 mm  
**3484** mit Ø 10, 51 mm  
**3485** ohne Ø 10

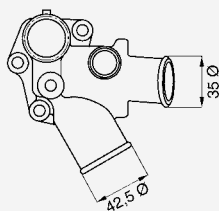

**Typ 3431**

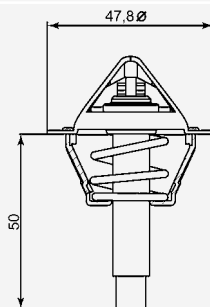

**Typ 3457**

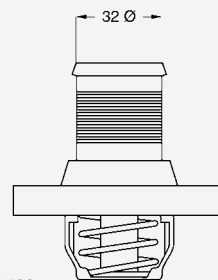

**Typ 3463**

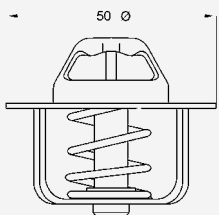

**Typ 3466**

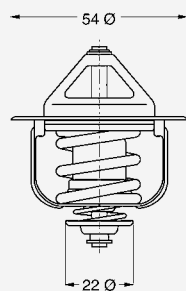

**Typ 3467**

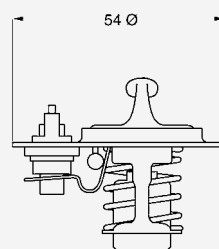

**Typ 3468**

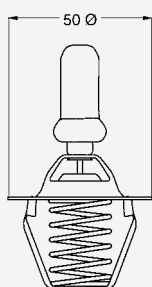

**Typ 3469**

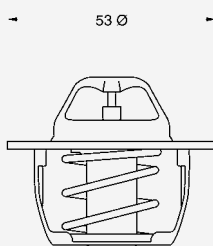

**Typ 3470**

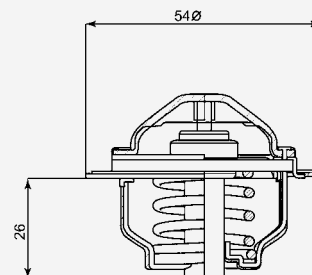

**Typ 3472**

# Einbaumaße Assembly dimensions

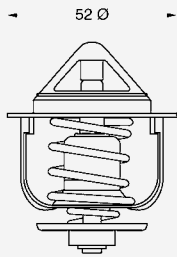

Typ 3477

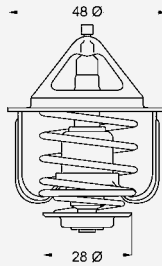

Typ 3478

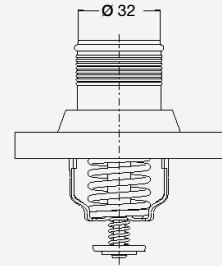

Typ 3483

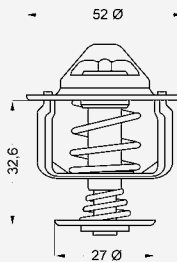

Typ 3497

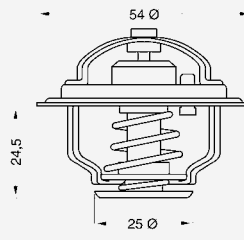

Typ  
4003 ohne Entlüftungsventil oder -kerbe  
4008 mit Entlüftungsventil  
4015 mit Entlüftungsventil

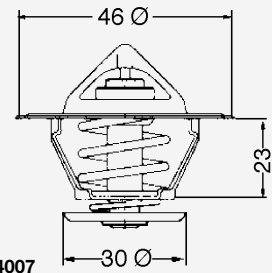

Typ 4007

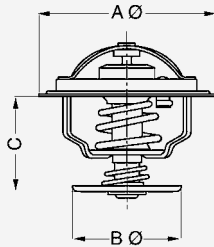

Typ	A	B	C	
4006	54	35	33	mit Entlüftungsventil
4026	54	28	30	mit Positionskerbe
4029	54	29	32	mit Entlüftungsventil
4033	56	34	33	ohne Entlüftungsventil oder -Kerbe
4154	54	29	32	mit Entlüftungsventil
4253	54	35	31	Ventilteller gummi- beschichtet
4256	54	35	31	ohne Entlüftungsventil oder -Kerbe
4272	54	35	31	mit Entlüftungsventil

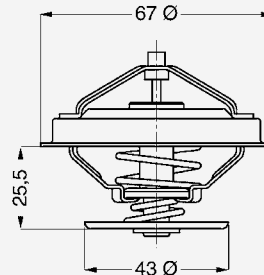

Typ	
4030	mit Entlüftungskerbe
4059	
4064	mit Entlüftungsventil kühlenseitig
4078	mit Entlüftungsventil motorseitig
4083	mit Entlüftungskerbe
4112	mit Entlüftungsventil
4122	mit Entlüftungsventil
4158	mit Entlüftungsventil

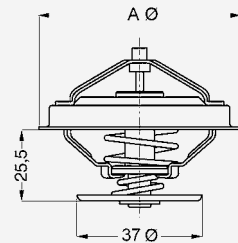

Typ	A	B	
4049	67	37	ohne Entlüftungsventil oder -kerbe
4088	67	37	ohne Entlüftungsventil oder -kerbe
4132	75	43	mit Entlüftungskerbe
4116	67	37	Ventilteller gummi- beschichtet
4117	67	37	mit Entlüftungskerbe

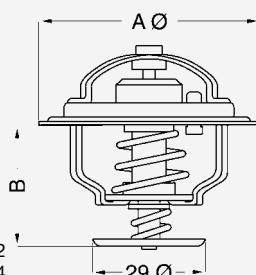

Typ	A	B
4022	54	32
4126	52	34
4154	54	32

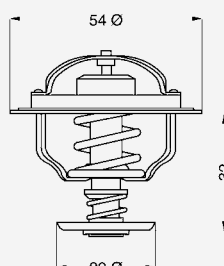

Typ 4038

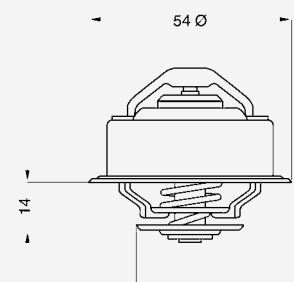

Typ 4089

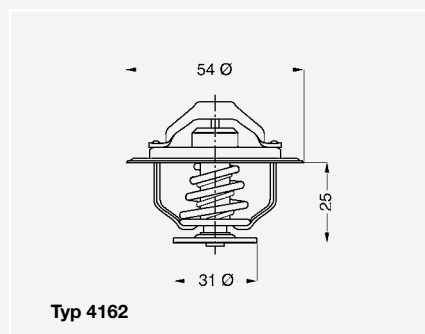
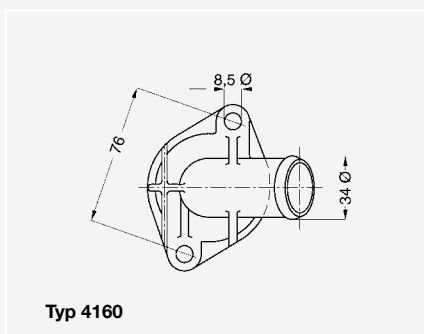
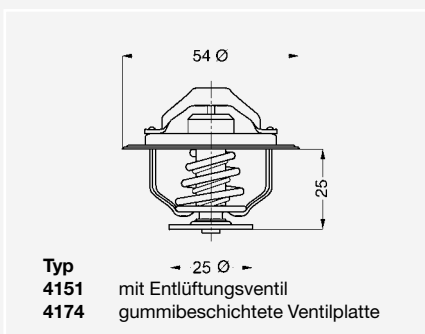
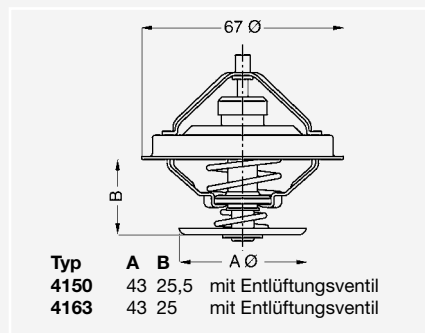
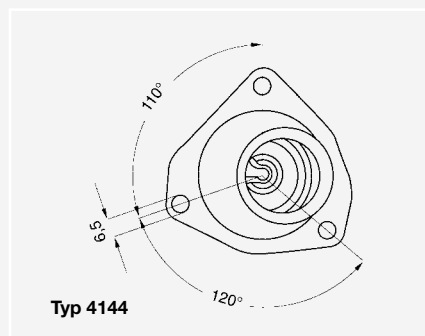
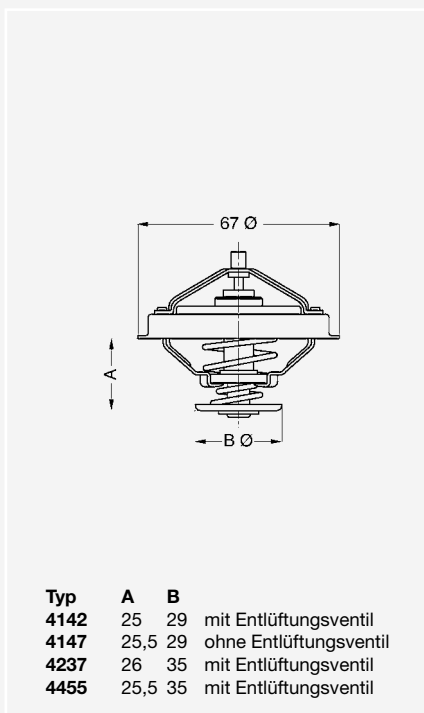
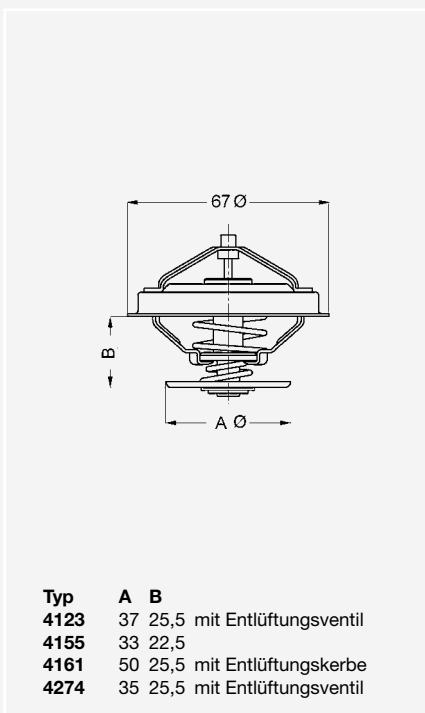
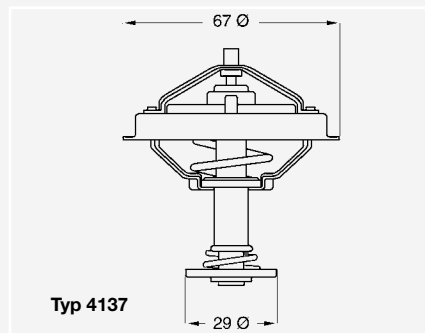
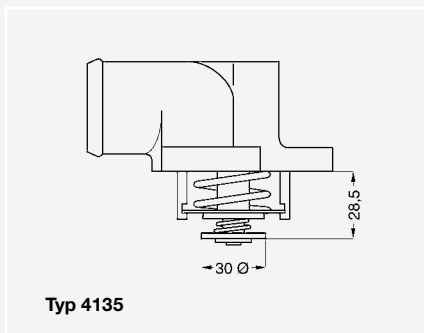
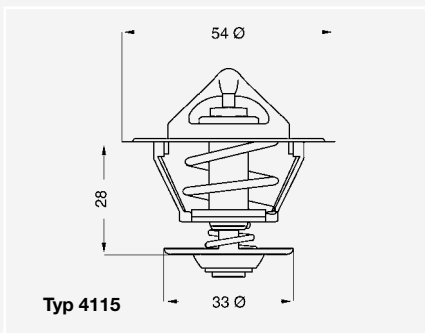
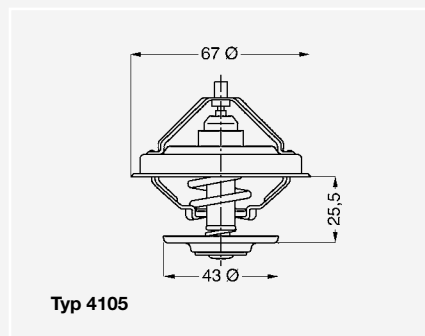
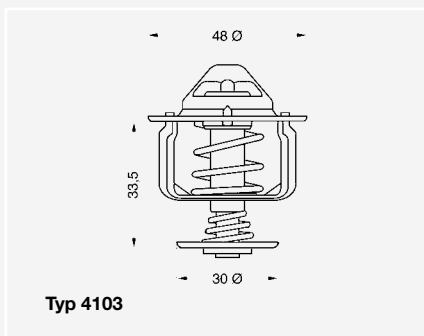
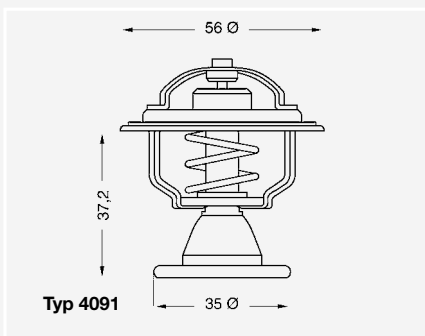
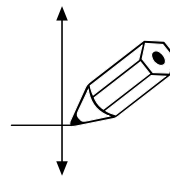

# Einbaumaße Assembly dimensions

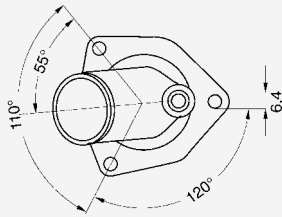

Typ 4164

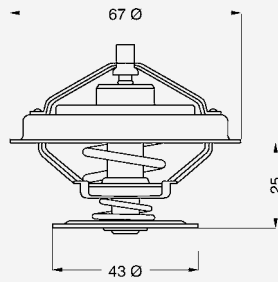

Typ 4165 mit Entlüftungsventil

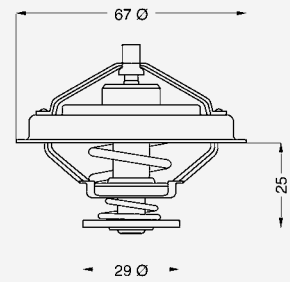

Typ 4166 mit Entlüftungsventil

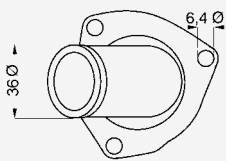

Typ 4168

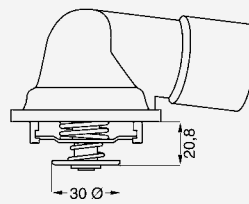

Typ 4175

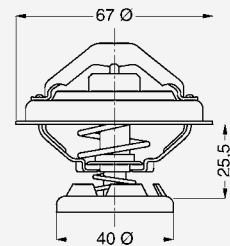

Typ 4176

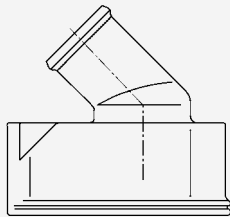

Typ 4177

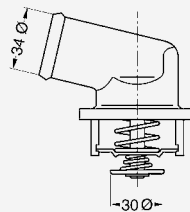

Typ 4178

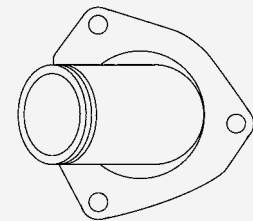

Typ 4180

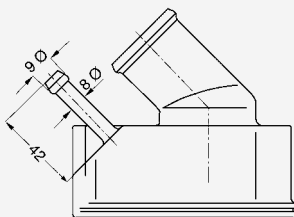

Typ 4183

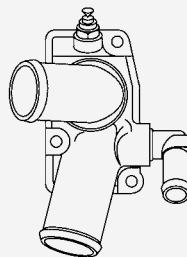

Typ 4188

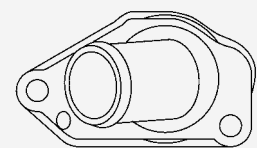

Typ 4189

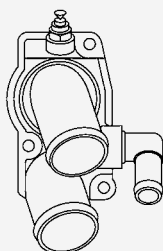

Typ 4193

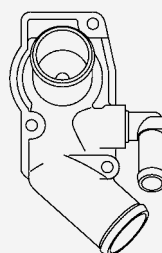

Typ 4198

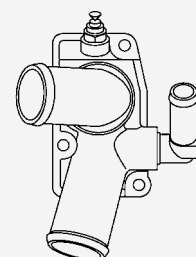

Typ 4201



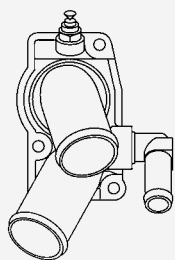
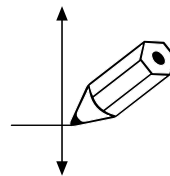

Typ 4207

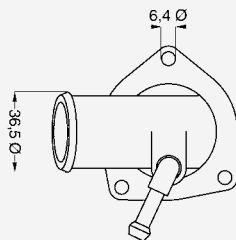

Typ 4208

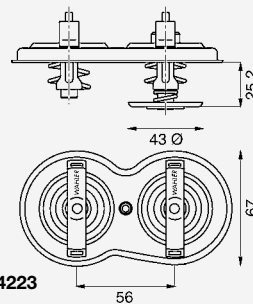

Typ 4223

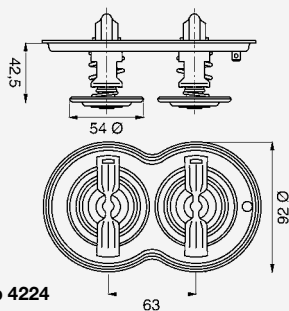

Typ 4224

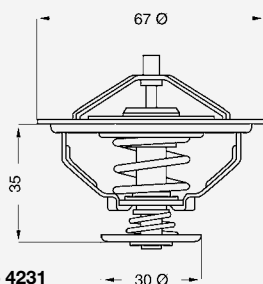

Typ 4231

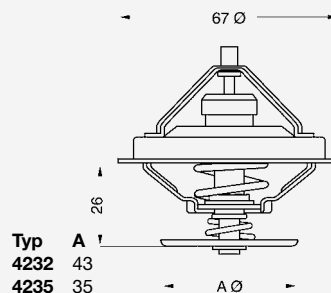

Typ 4232 43  
4235 35

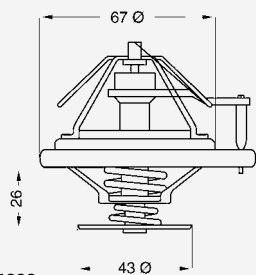

Typ 4233

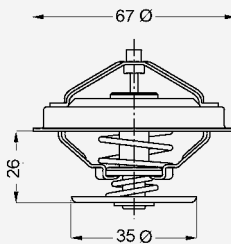

Typ 4236

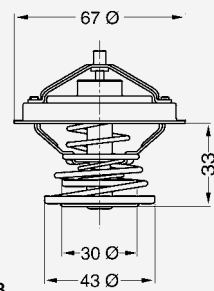

Typ 4238

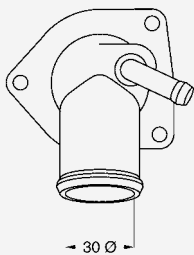

Typ 4242

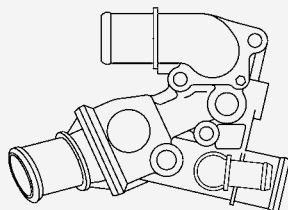

Typ 4246

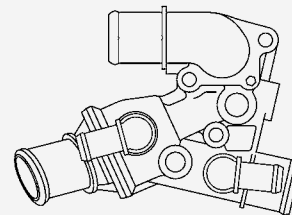

Typ 4247 mit M 16 x 1,5 / M 22 x 1,5  
4434 mit M 16 x 1,5  
4436 mit M 16 x 1,5 / M 16 x 1,5

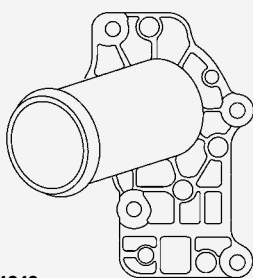

Typ 4249

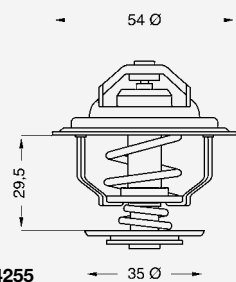

Typ 4255

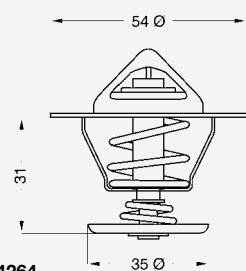

Typ 4264

# Einbaumaße Assembly dimensions

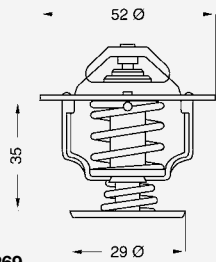

Typ 4269

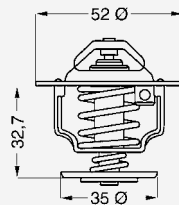

Typ 4270

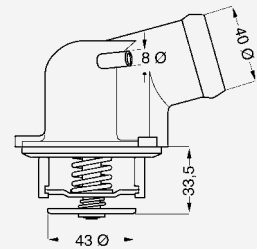

Typ 4275

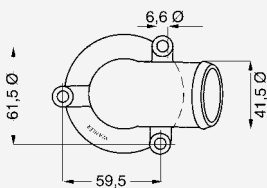

Typ 4276

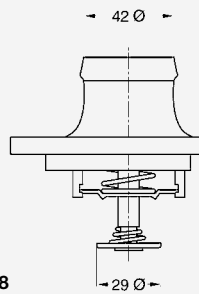

Typ 4278

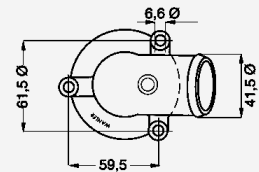

Typ 4279

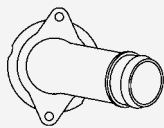

Typ 4280

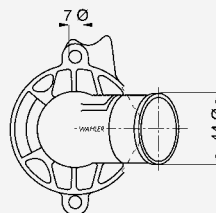

Typ 4281

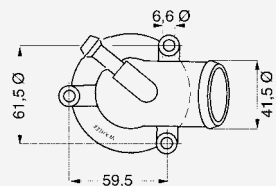

Typ 4286

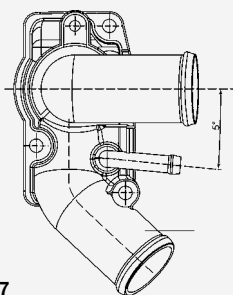

Typ 4297

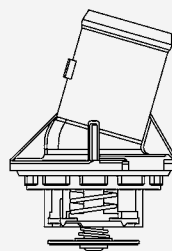

Typ 4298

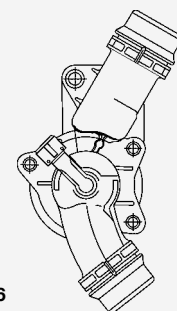

Typ 4326

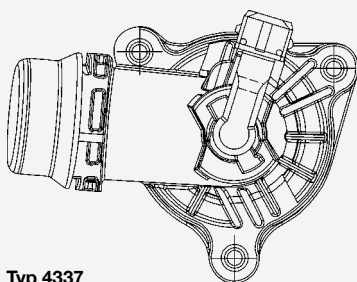

Typ 4337

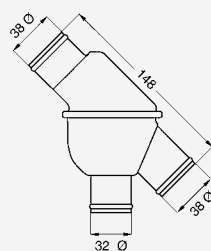

Typ 4341

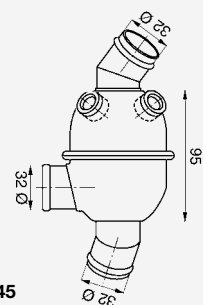

Typ 4345

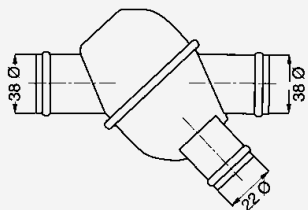
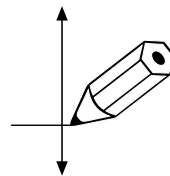

Typ 4351

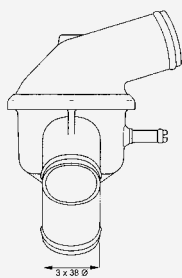

Typ 4368

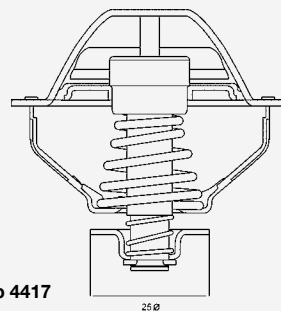

Typ 4417

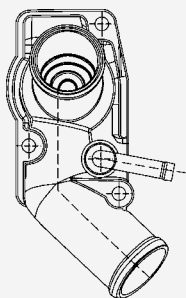

Typ 4433

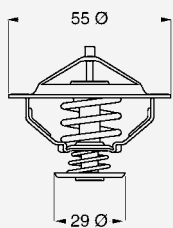

Typ 4446

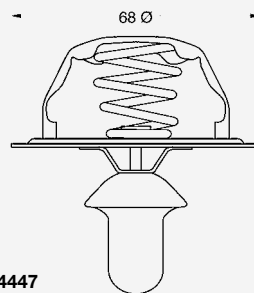

Typ 4447

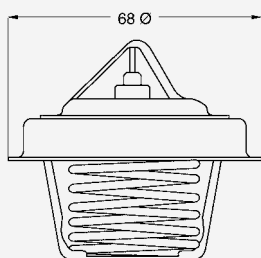

Typ 4449

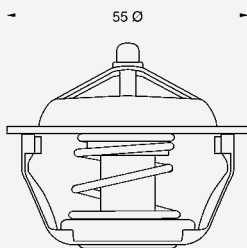

Typ 4450

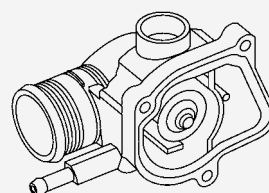

Typ 4453

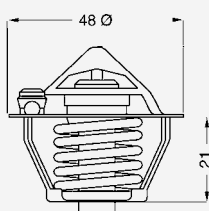

Typ 4457

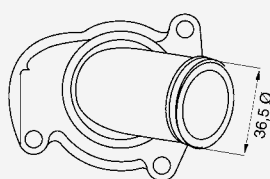

Typ 4459

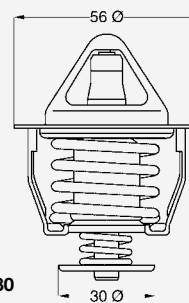

Typ 4480

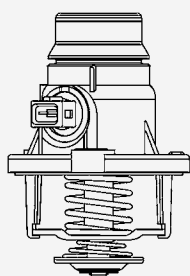

Typ 4508

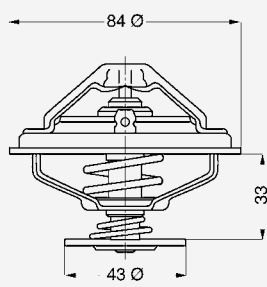

Typ 4516  
4519

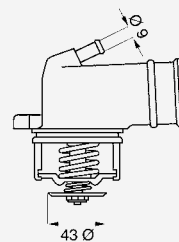

Typ 4517

# Einbaumaße Assembly dimensions

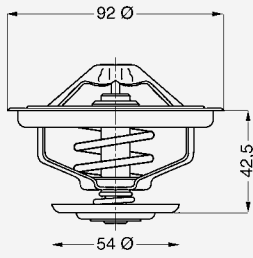

Typ 4520

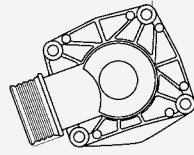

Typ 4594

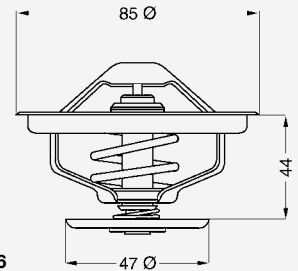

Typ 4596  
4530 mit Entlüftungskerbe

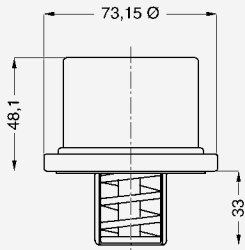

Typ 4619

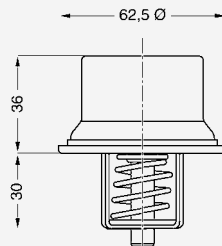

Typ 4621

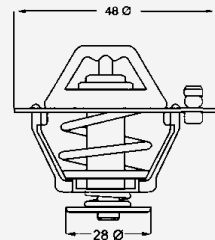

Typ 4634

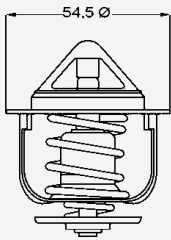

Typ 4635

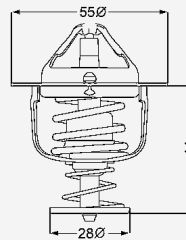

Typ 4637

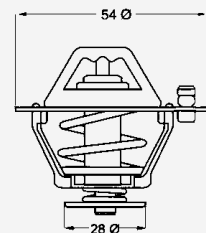

Typ 4638

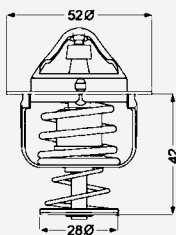

Typ 4639

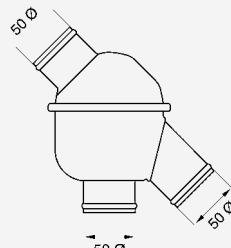

Typ 4663  
4684 mit Entlüftungsventil

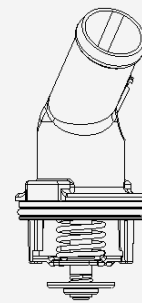

Typ 4814

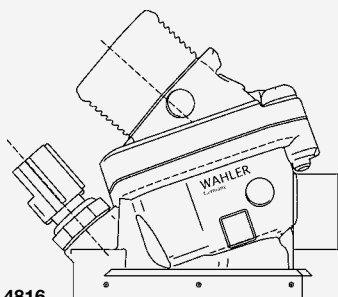

Typ 4816

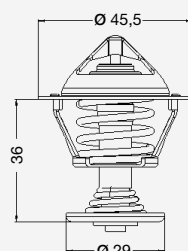

Typ 4821

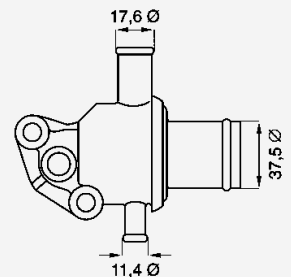

Typ 410007

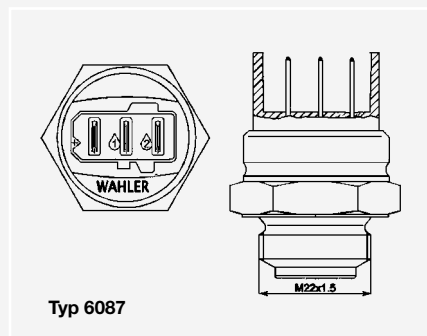
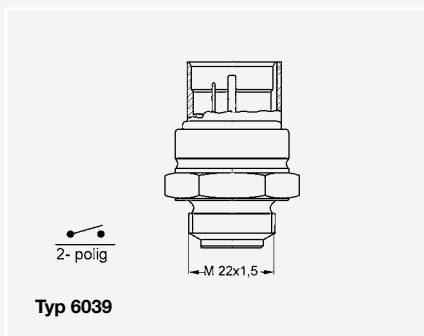
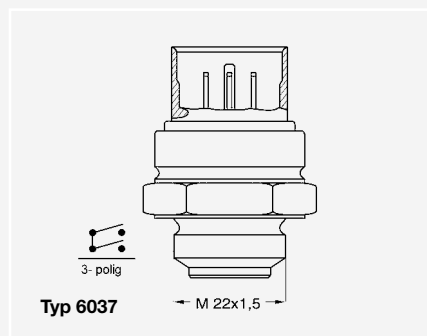
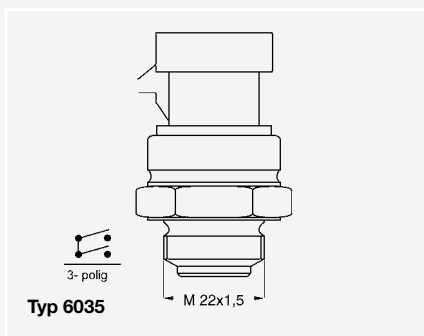
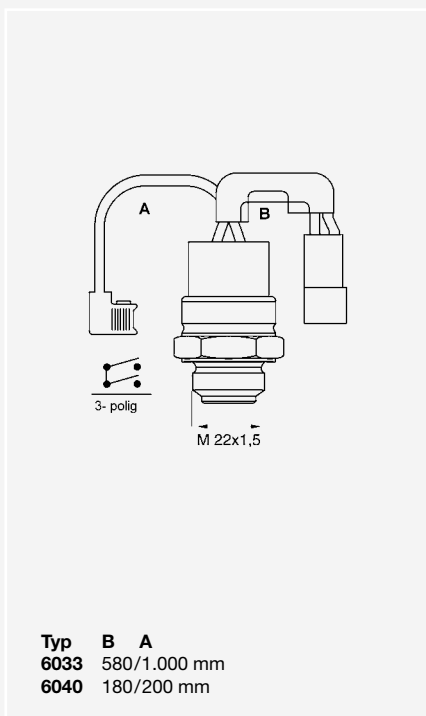
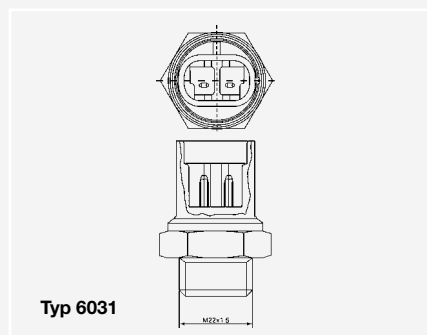
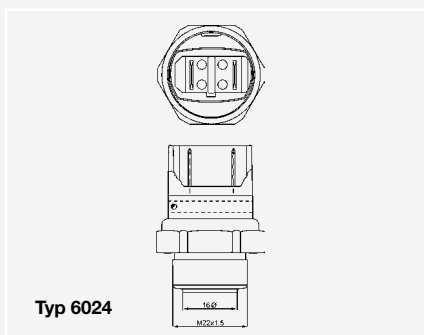
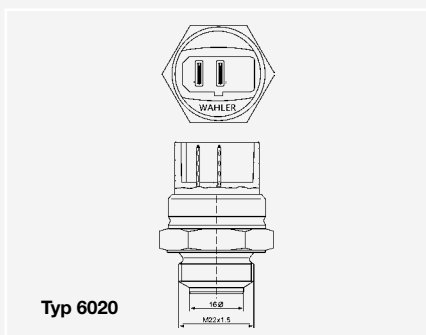
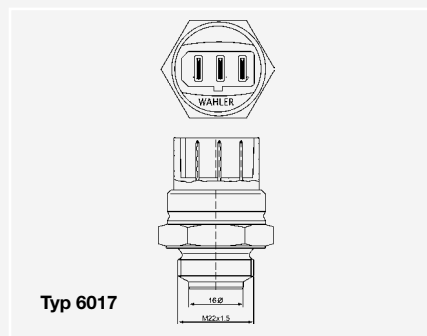
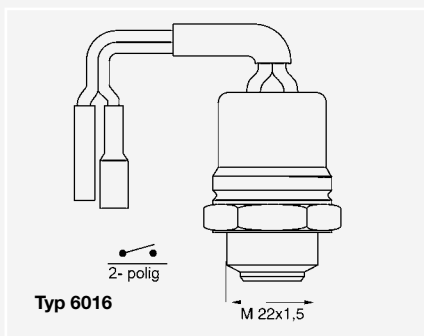
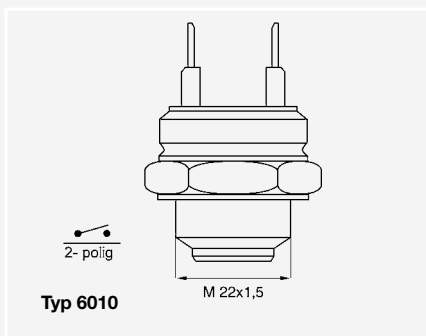
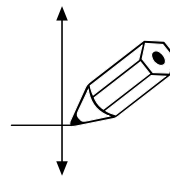

# Erklärungen | Explanations | Nomenclatures

2 / 3 Anschlüsse	2 / 3 connections	2 / 3 connexions
2 / 4 polig	2 / 4 pole	2 / 4 pôle
2-teiliges Aluminiumgehäuse	2-piece aluminum housing	2 pièces boîtier en aluminium
A = Aktuator	A = actuator	A = Actuateur
AGR-Ventil	EGR valve	vanne EGR
Automatikgetriebe	automatic transmission	transmission automatique
Chassis-no. / Chassis	Chassis number	numéro de chassis
D = Drosselklappe	D = throttle flap	D = soupape d'étranglement
Deckel Thermostatgehäuse	thermostat housing cover	couvercle du boîtier de thermostat
Dichtring	seal	joint
Dichtung	seal	joint d'étanchéité
DPF = Dieselpartikelfilter	DPF = Diesel particle filter	DPF = diésel filtre à particules
Drosselklappe	throttle flap	soupape d'étranglement
Einbauseite Zylinderkopf	attached to the cylinder head	attaché à la culasse
Einsatzthermostat elektrisch	insert Theromostat electrical	thermostat intérieur électrique
elektrisch beheizt	electrical heated	commande électrique
elektrischgesteuert	electrically controlled	commandés électriquement
ersatzlos entfallen	no longer available	n'est plus livré
Europa	Europe	Europe
Excl. = exclude	Excl. = exclude	Excl. = exclue
für OE-Nummer	for original number	pour réf. OE no.
Gehäuse	housing	boîtier
Gewinde	thread	filetage
Japan	Japan	Japon
Katalysator	catalyst	catalyseur
Katalysatorart	catalyst type	type de catalyseur
Kennfeldthermostat	electrically heated thermostat	thermostat piloté
Klimaanlage	air conditioner	système de climatisation
Kunststoffdeckel	plastic cover	plastique couvercle
L = AGR-Leitung	L = EGR-pipe	L = tuyau EGR
Leitung Drosselklappe zum Zylinderkopf	pipe throttle valve to cylinder head	tuyau gaz à culasse
Metalldeckel	metal cover	métal couvercle
mit	with	avec
Motor-no./ Motornummer	engine number	numéro de moteur
oben	upper	supérieur
ohne	without	sans
Ölkühlung	oil cooling	refroidissement de l'huile
Organisationsnummer	organisation number	numéro d'organisation
Partikelfilter	diesel sootfilter	filtre à particules
pneumatisch	pneumatic	pneumatique
Retarder	Retarder	retardateur
Rußpartikelfilter	particle filter	filtre à particules
Schaltgetriebe	manual transmission	boîte de vitesses manuelle
schwarz	black	noir
Serie / Serienausführung	series / Standard equipment	série / en série
solange vorrätig	available while stocks last	jusqu'à épuisement des stocks
thermisch	thermal	thermique
unten	lower	inférieur
USA	USA	USA
V = AGR-Ventil	V = EGR valve	V = vanne EGR
Variante	variant	variante
Wasserkühlung	water cooling	refroidissement par eau
zusätzlich benötigte Artikel	additionally required parts	article supplémentaire nécessaire
XXX → = ab	XXX → = from	XXX --> = à partir
→ XXX = bis	→ XXX = up to	--> XXX = jusque
XXX → XXX = von → bis	XXX → XXX = from → up to	XXX --> XXX = à partir --> jusque
▲ = neuer Artikel	▲ = new part number	▲ = nouveau article
● = Auslaufteil	● = article to be discontinued	● = article écoulé





**BorgWarner Esslingen GmbH**

Hindenburgstrasse 146

73730 Esslingen

Deutschland / Germany

Telefon: +49 711 3152-0

Telefax: +49 711 3152-210

---